

Y Y I

E E X X Y I

Z X X X X X X X

A B C D E F G H I J K L M N O P

Z X X X X X X X X X X X X X

M M M E E E E E E E E M M M E E E E E

1.0 INTRODUCTION

1.1 SCOPE

The complete Spacecraft Operational Data Book for the manned missions will consist of five separate volumes. These are defined as follows:

Volume I - CSM Data Book

Part I - Constraints and Performance
Part II - Launch Mission Rule Redlines

Volume II - LM Data Book

Part I - Constraints and Performance
Part II - Launch Mission Rule Redlines

Volume III - Mass Properties Data Book

Volume IV - EMU Data Book

Volume V - ALSEP Data Book

Volumes I and II present operational information on the capabilities and limitations of the spacecraft. A brief discussion of the purpose and scope of volume III follows:

1.2 PURPOSE

The purpose of this document is to provide spacecraft mass properties data per mission for use in the mission planning activities, trajectory documentation, mission simulations, and to provide all necessary information and documentation for consumable loading. The data contained herein represent the latest predictions for the launch configuration mass properties and consumable loadings. Updates to these data will be provided based on the actual weight and balance data for each spacecraft. Mass properties data will be maintained and updated through the actual consumables loading.

Section 2.0 presents relevant spacecraft configuration drawings and station locations which may be useful in describing the location of various spacecraft components and the relationship of coordinate systems in the launch and docked configuration.

Section 3.0 presents mass properties and consumable loading data for each mission. Included in this section are the predicted mass properties for the launch configuration, the docked configuration, the normal entry, and for launch aborts.

Sections 4.0 and 5.0 contain consumables mass properties data and mission independent consumable loading information for the CSM and LM, respectively. In addition, CM ablator material data are provided in Section 4.0 to aid the user in determining CM mass properties during reentry.

Amendments to this document will be made by page additions or replacements. Data changed by an amendment will be denoted by an amendment date in the upper right hand corner and a vertical bar in the page margin to locate the change.



M M M E E E L L L E E M M H H E E L L

TABLE 1-1 (Continued)

ICG	In-Flight Coverall Garment
IV	Intravehicular
JETT	Jettison
LES	Launch Escape System
LEV	Launch Escape Vehicle
LV	Launch Vehicle
LH	Left Hand
LEB	Left Hand Equipment Bay
LIQ	Liquid
LEC	Lunar Equipment Conveyor
LM	Lunar Module
LOI	Lunar Orbit Insertion
LS	Lunar Surface
LMP	LM Pilot
LUN	Lunar
MC	Main Chute
MECH	Mechanism
MCC	Midcourse Correction
N/A	Not Available
OPS	Oxygen Purge System
PR	Pair
PGA	Pressure Garment Assembly
PROC	Procedure
RAD	Radiation
RCS	Reaction Control System
RELOC	Relocation
RESTR	Restraint
RT	Right
RH	Right Hand
RHEB	Right Hand Equipment Bay
SRC	Sample Return Container
SCRS	Scissors
SEP	Separation
SM	Service Module
SLA	Service Module LM Adapter
SPS	Service Propulsion System
S/C	Spacecraft
STG	Stage
STORE	Storage Tank
STOW	Stowage



TABLE 1-1 (Continued)

SUBSYS	Subsystem
SUMP	Sump Tank
SURF	Surface
SYS	System
RSS	Root Sum Square
TEMP	Temporary
TBD	To Be Determined
TEI	Tranearth Insertion
XFR	Transfer
TLI	Translunar Insertion
TRANS	Transposition
TRANS/DOCK	Transposition and Docking
UMB	Umbilical
UPR	Upper
UEB	Upper Equipment Bay
UCTA	Urine Collection Transfer Assembly
WT	Waist Tether
W/	With
W/O	Without



M M M E E E U E E E E M M H M E E E

2.0 CONFIGURATION AND
REF. STATION LOCATIONS

1 1 1

1 1 1 1 1 1

1 1 1 1 1 1 1 1 1 1

1 1 1 1 1 1 1 1 1 1 1 1

1 1 1 1 1 1 1 1 1 1 1 1 1 1 1 1 1 1 1 1

2.0 CONFIGURATION

This section provides relevant spacecraft configuration drawings and station locations which may be useful in describing the location of various spacecraft components and the relationship of coordinate systems in the launch and docked configuration for Block II CSM spacecraft and Lunar Modules.

Configuration data are presented in the following categories and order:

1. Apollo Vehicle Coordinate System.
2. Saturn V Vehicle Outboard Profiles and Reference Dimensions.
3. Apollo Spacecraft Reference Stations, Thrust Chamber Locations, and CSM Consumables Tank Locations.
4. Lunar Module Reference Stations, Thrust Chamber Locations and LM Consumables Tank Locations.

Consumables mass properties data for the CSM and LM may be found in Sections 4.0 and 5.0, respectively, of this volume. These consumables mass property data must be compared to the onboard consumable loading data for each mission in Section 3.0 to determine the actual mission tanked consumables mass properties.



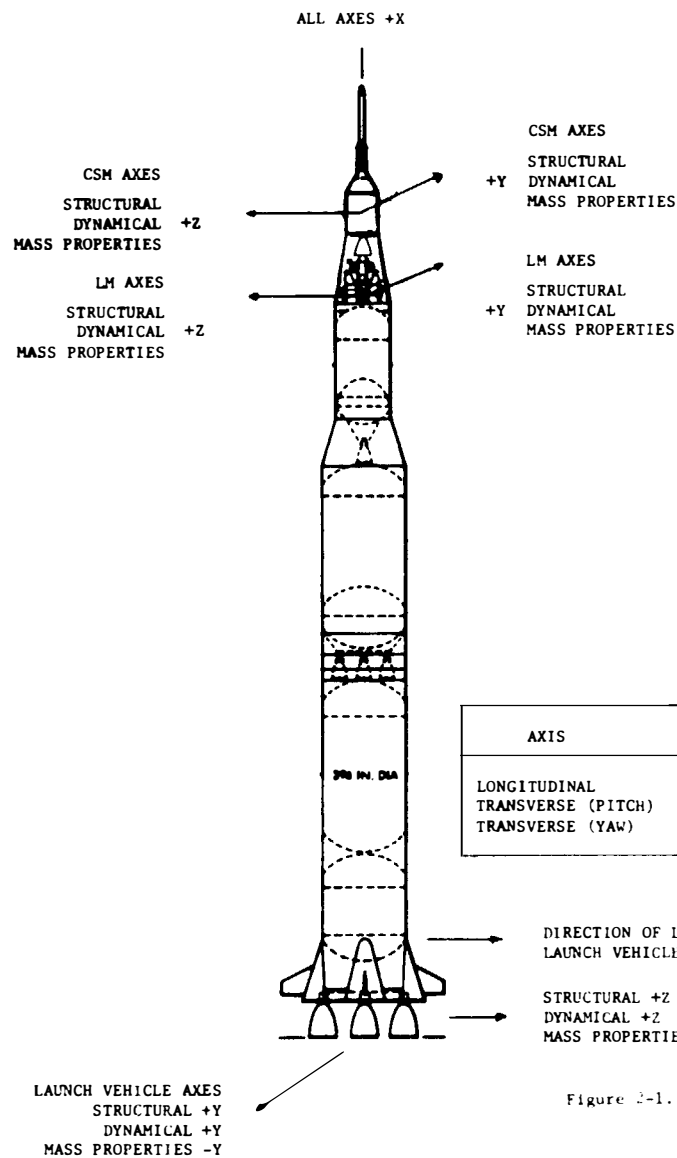

NOTES:

1. DYNAMICAL AXES ORIGIN. THE DYNAMICAL AXES ORIGINS ARE LOCATED AT THE CENTER OF MASS FOR EACH CONFIGURATION.
2. STRUCTURAL AXES ORIGIN.
 - a. THE LAUNCH VEHICLE STRUCTURAL AXIS ORIGIN IS 100 INCHES BELOW THE S-1C GIMBAL REFERENCE PLANE.
 - b. THE CSM STRUCTURAL AXIS ORIGIN IS 1000 INCHES BELOW THE MOLD LINE OF THE HEAT SHIELD MAIN STRUCTURE ABLATION INTERFACE.
 - c. THE LM STRUCTURAL AXIS ORIGIN IS 200 INCHES BELOW LM ASCENT STAGE BASE.
3. MASS PROPERTIES AXES ORIGIN.
 - a. THE SPACECRAFT MASS PROPERTIES AXIS ORIGIN IS COINCIDENT WITH THE CSM STRUCTURAL AXIS ORIGIN.
 - b. THE LAUNCH VEHICLE MASS PROPERTIES AXIS ORIGIN IS COINCIDENT WITH ITS STRUCTURAL AXIS ORIGIN.

AXIS	AXIS SYMBOL	MOMENT SYMBOL	POSITIVE* ROTATION	LAUNCH VEHICLE ANGLE	CSM ANGLE	LM ANGLE	ANGLE SYMBOL	LINEAR VELOCITY	ANGULAR VELOCITY
LONGITUDINAL	X	L	+Y TO +Z	ROLL	ROLL	ROLL	ϕ	u	p
TRANSVERSE (PITCH)	Y	M	+Z TO +X	PITCH	PITCH	PITCH	θ	v	q
TRANSVERSE (YAW)	Z	N	+X TO +Y	YAW	YAW	YAW	ψ	w	r

*POSITIVE ROTATIONS ARE DEFINED USING AXES FOR VEHICLE BEING CONSIDERED
 $\theta_{CSM} = -\theta_{LV}$, $\psi_{CSM} = -\psi_{LV}$

Figure 2-1. Vehicle Coordinate Axes and Notation System.

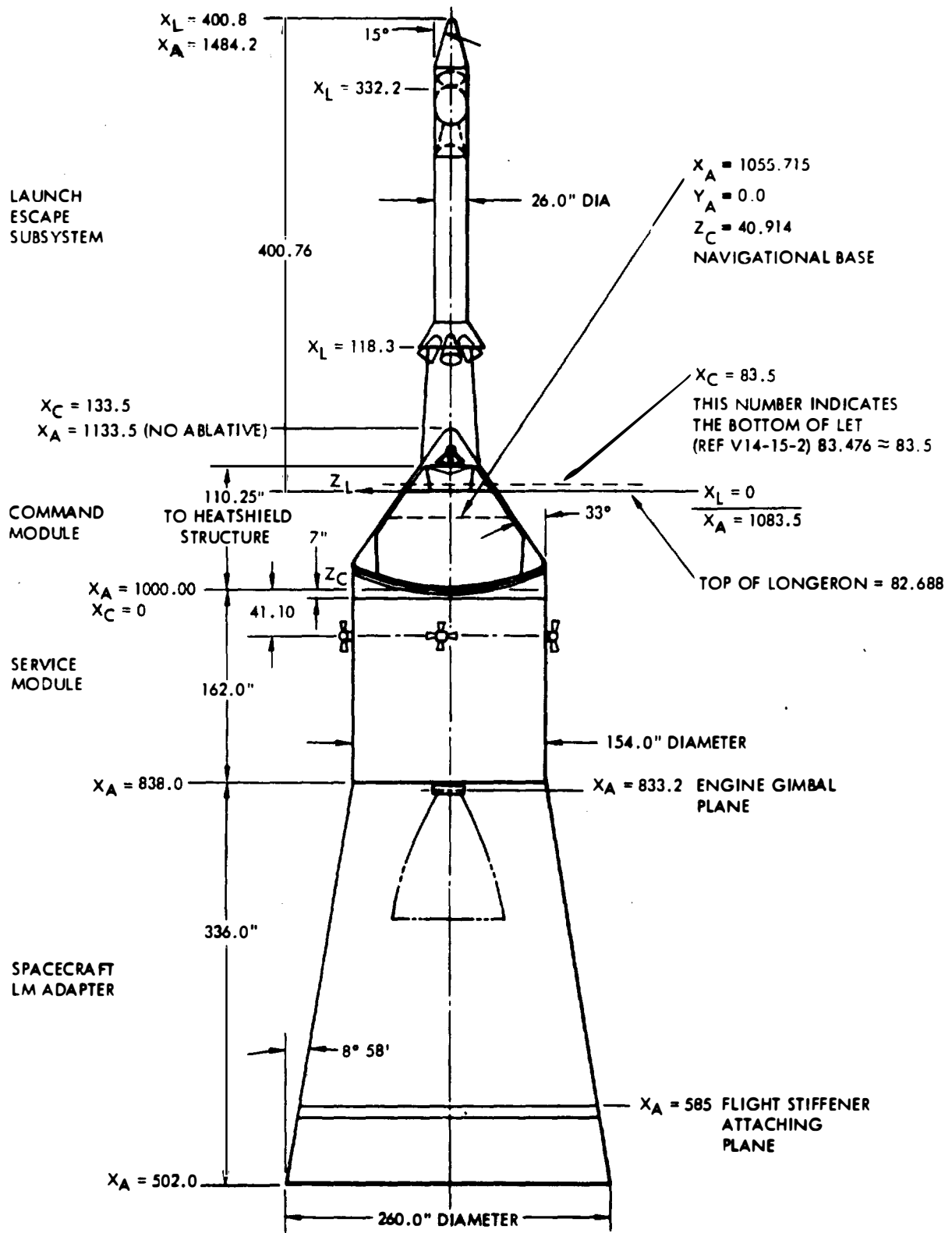

Figure 2-2. Apollo Spacecraft Reference Dimensions



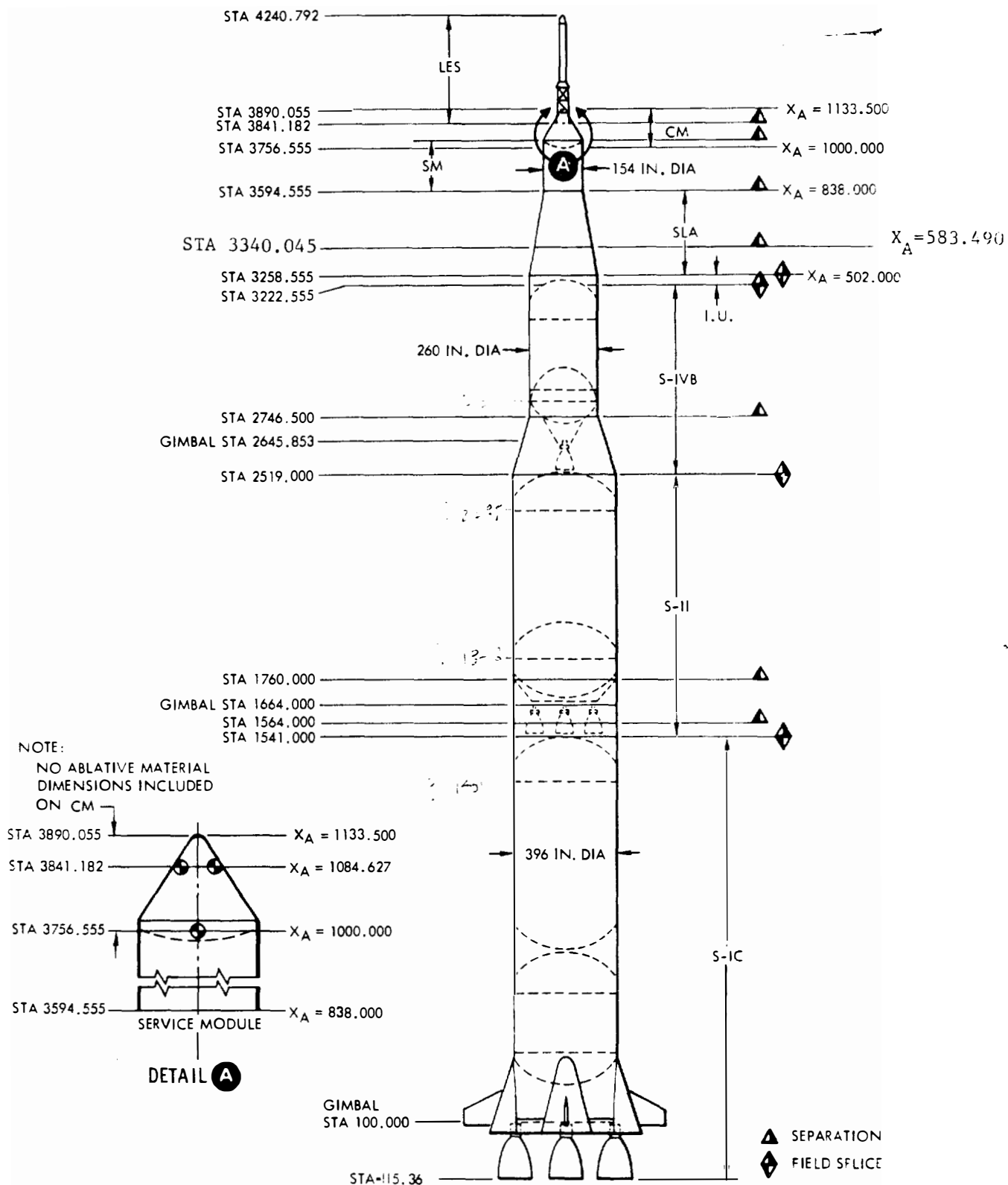

Figure 2-3. Saturn V/Apollo Configuration

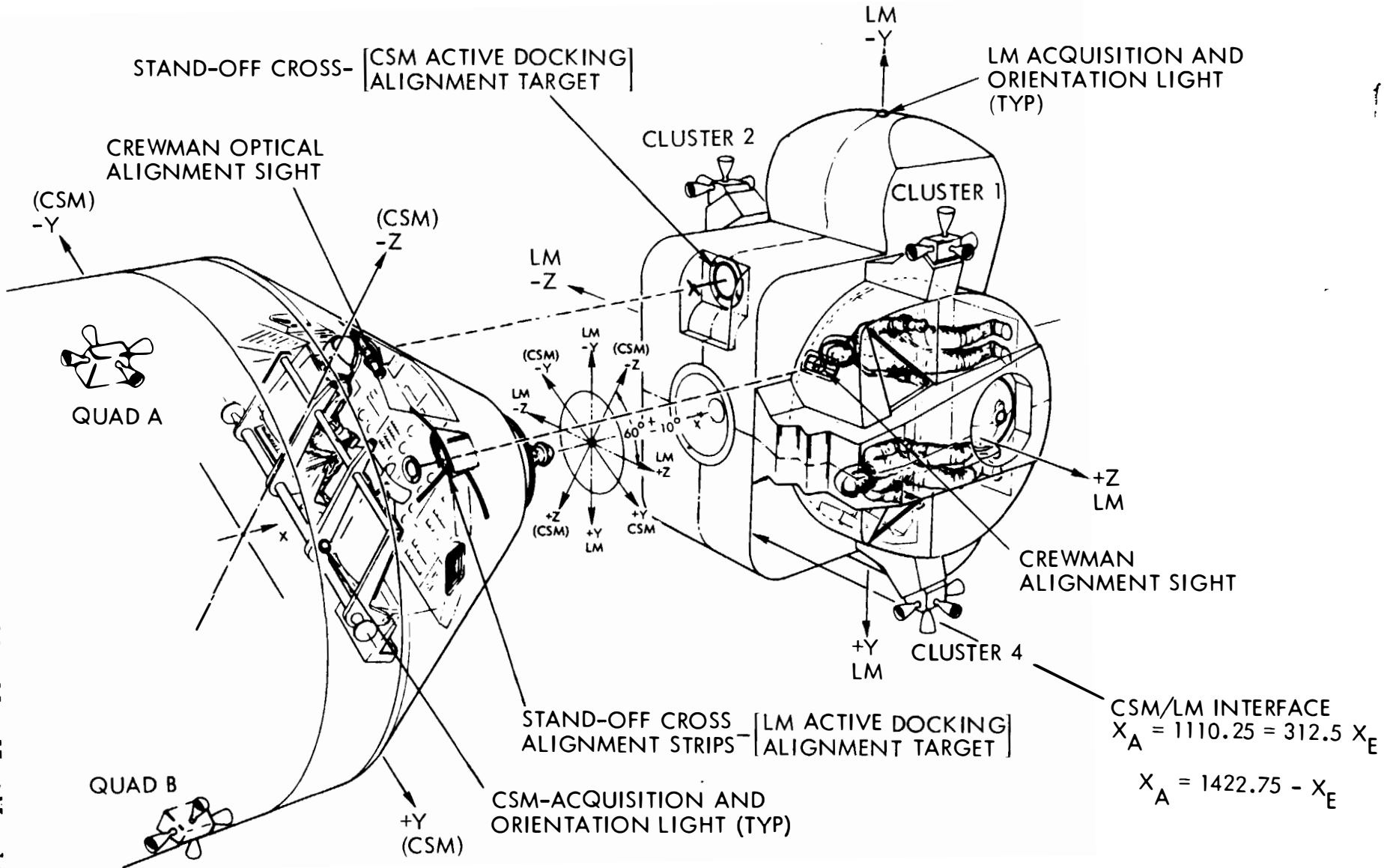

Figure 2-4. LM/CSM DOCKED ORIENTATION

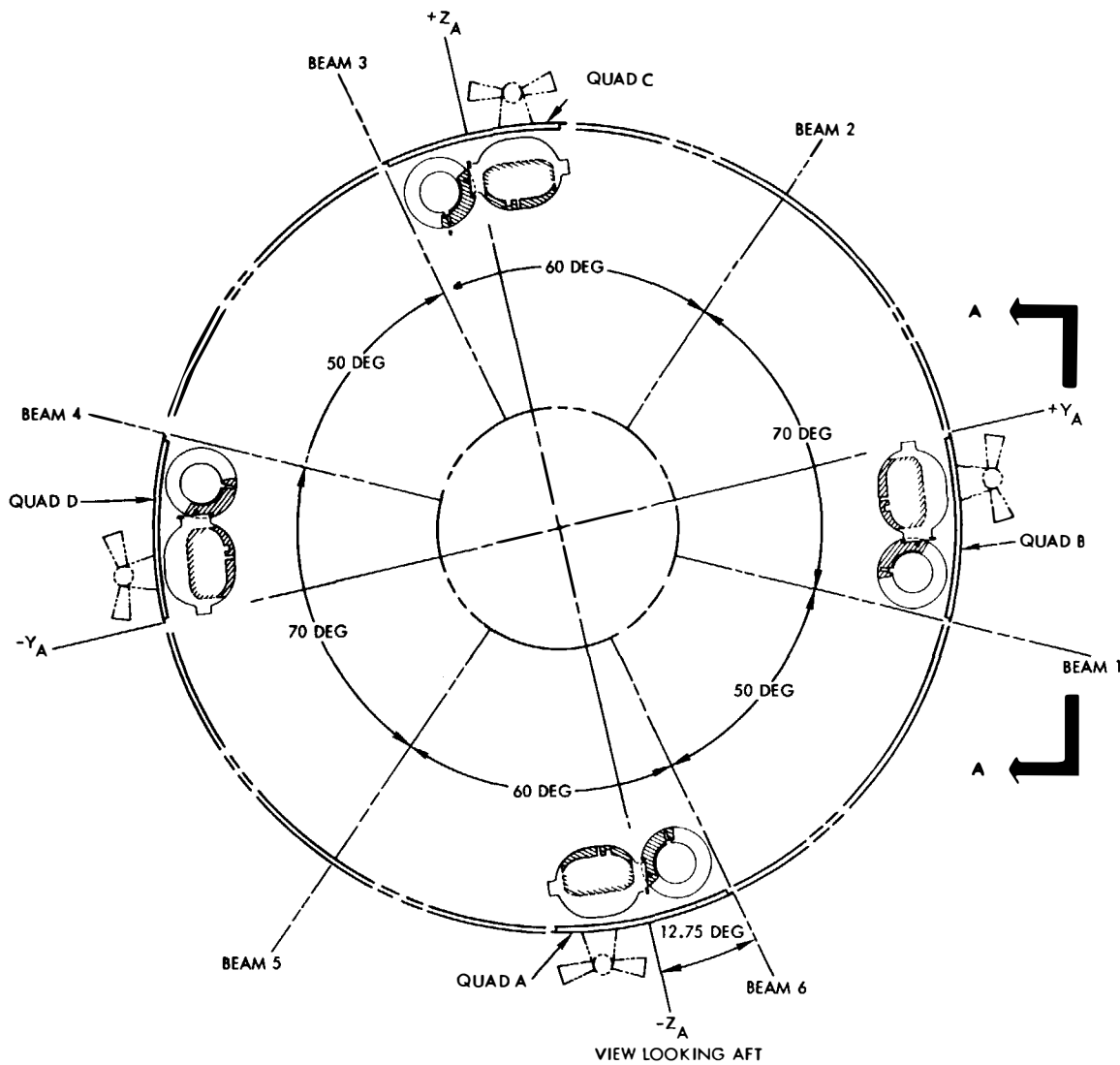
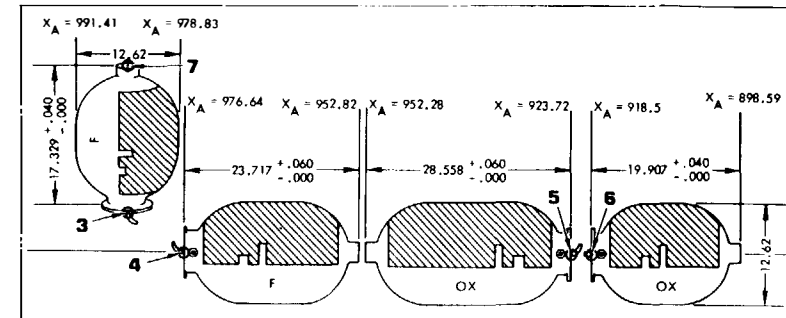

Figure 2-6. SM/RCS TANK LOCATIONS IN CSM (X_A) COORDINATE SYSTEM

2-7

SM RCS QUAD A AND C

TANK POINT NUMBER	Y_A		Z_A	
	QUAD A	QUAD C	QUAD A	QUAD C
3	+1.708	-1.708	-69.818	+69.818
4	+7.346	-7.346	-68.688	+68.688
5	+7.346	-7.346	-68.688	+68.688
6	+7.346	-7.346	-68.688	+68.688
7	-15.535	+15.535	-68.083	+68.083



← FWD

VIEW A-A

(POINTS 1 AND 2 OMITTED)

HELIUM TANK NOT SHOWN FOR CLARITY

SM RCS QUAD B AND D

TANK POINT NUMBER	Y_A		Z_A	
	QUAD B	QUAD D	QUAD B	QUAD D
3	+67.171	-67.171	-19.123	+19.123
4	+64.665	-64.665	-24.300	+24.300
5	+64.665	-64.665	-24.300	+24.300
6	+64.665	-64.665	-24.300	+24.300
7	+69.805	-69.805	-1.995	+1.995

SNA-8-D-027(III)REV 2

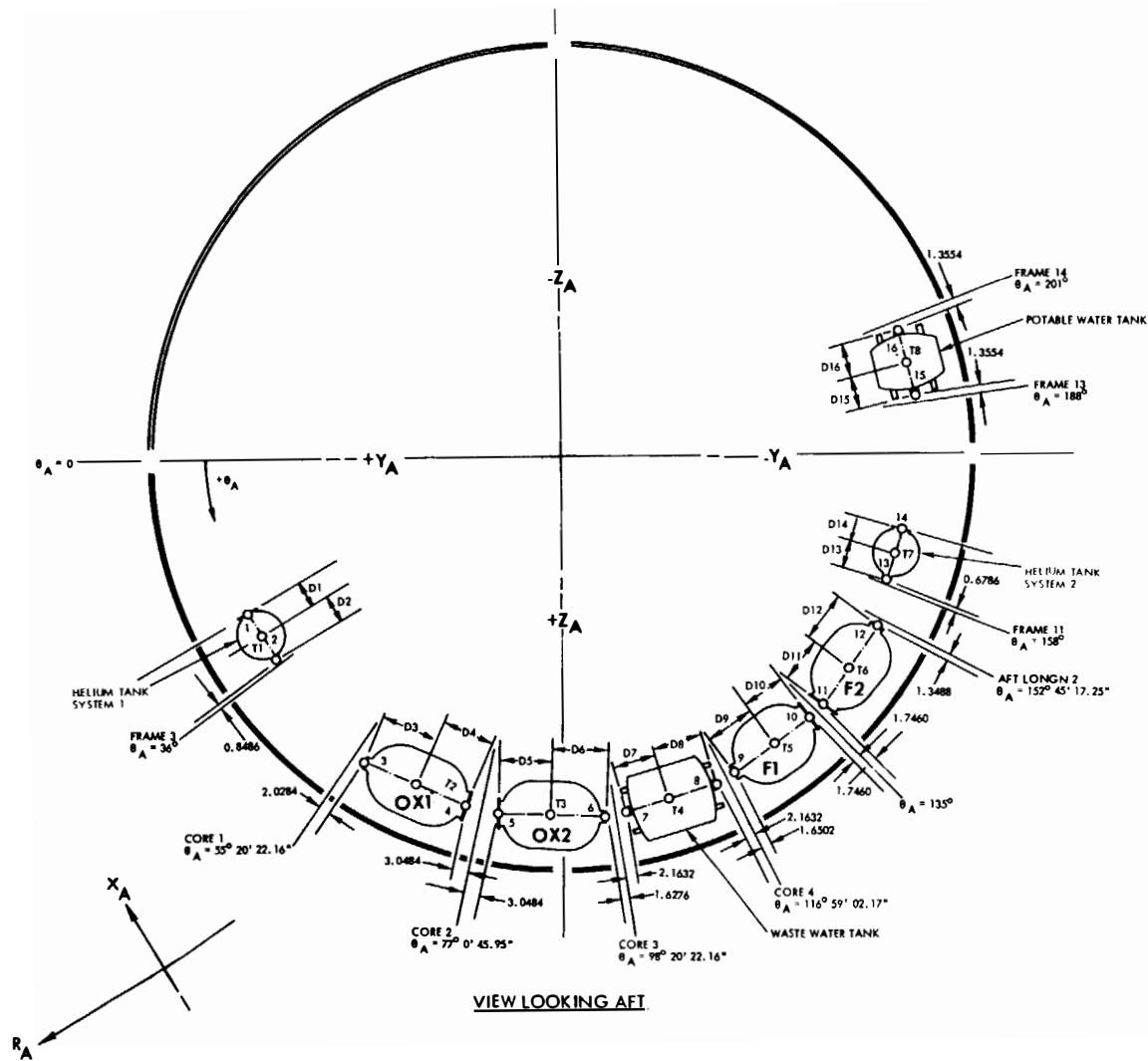

*OXIDIZER AND FUEL TANKS
HAVE DIAMETER OF 12.62 INCHES
*ALL DIMENSIONS GIVEN IN
INCHES

OX1 - SYSTEM 1 OXIDIZER TANK
OX2 - SYSTEM 2 OXIDIZER TANK
F1 - SYSTEM 1 FUEL TANK
F2 - SYSTEM 2 FUEL TANK

PT	X _A	Y _A	Z _A
1	1022.6000	57.3372	28.8372
2	↑	52.4137	37.0319
3		36.0214	55.6649
4		17.8326	63.7554
5		11.8917	65.1255
6		-8.0033	65.8185
7		-11.7159	65.0097
8		-28.0290	59.8155
9		-31.4605	58.1506
10		-45.4375	47.9067
11		-47.9067	45.4375
12		-58.1506	31.4605
13		-59.7521	23.4095
14		-62.5468	14.2672
15	↓	-65.0403	-10.5095
16	1022.6000	-61.9807	-22.3403

	DISTANCE
D ₁	4.8100
D ₂	4.7500
D ₃	10.2895
D ₄	9.6175
D ₅	9.6175
D ₆	10.2895
D ₇	8.5600
D ₈	8.5600
D ₉	9.0005
D ₁₀	8.3285
D ₁₁	8.3285
D ₁₂	9.0005
D ₁₃	4.7500
D ₁₄	4.8100
D ₁₅	6.1100
D ₁₆	6.1100

PT	X _A	Y _A	Z _A	R _A	θ _A
T1	1022.6000	54.8600	32.9603	64.0000	30° 59' 51.90"
T2	↑	26.6200	59.8467	65.5000	66° 09' 13.25"
T3		2.2800	65.4603	65.5000	88° 00' 18.64"
T4		-19.8725	62.4126	65.5000	107° 39' 42.17"
T5		-38.7200	52.8300	65.5000	126° 14' 17.90"
T6		-52.8300	38.7200	65.5000	143° 45' 42.10"
T7	↓	-61.1407	18.8670	63.9855	162° 51' 02.14"
T8	1022.6000	-63.5105	-16.4249	65.6000	194° 30'

Figure 2-7. CM/RCS TANK LOCATIONS IN APOLLO (X) COORDINATE SYSTEM

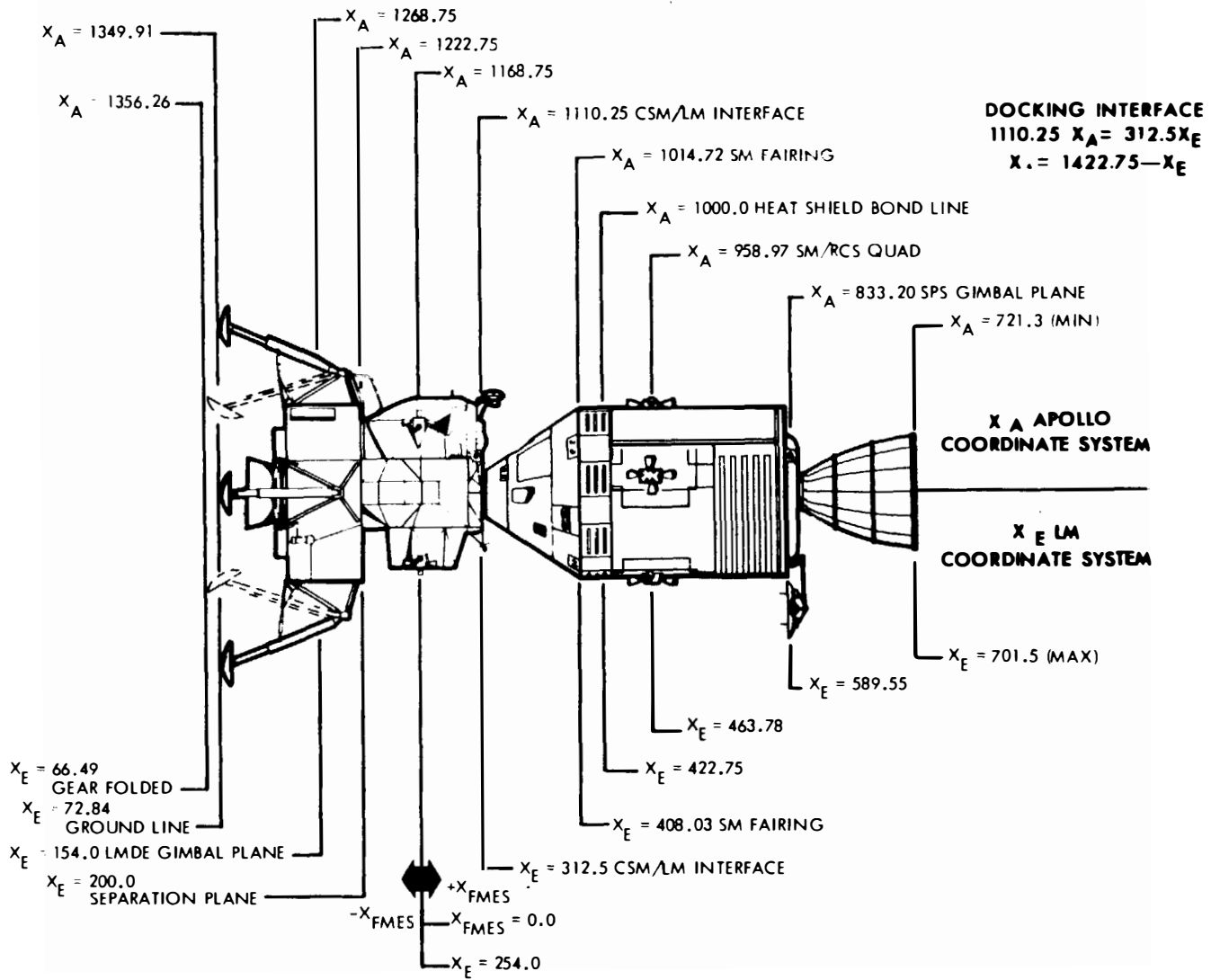
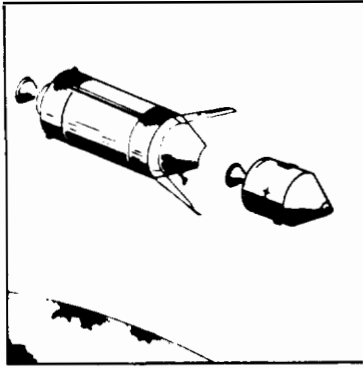
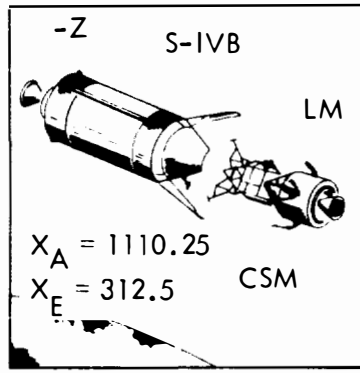

Figure 2-10. CSM/LM Docked Configuration Reference Dimensions

LM ADAPTER
DEPLOYED



TRANSLATION
SEPARATION



CSM/LM
SEPARATE
FROM S-IVB

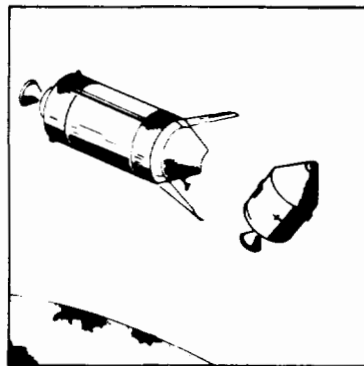
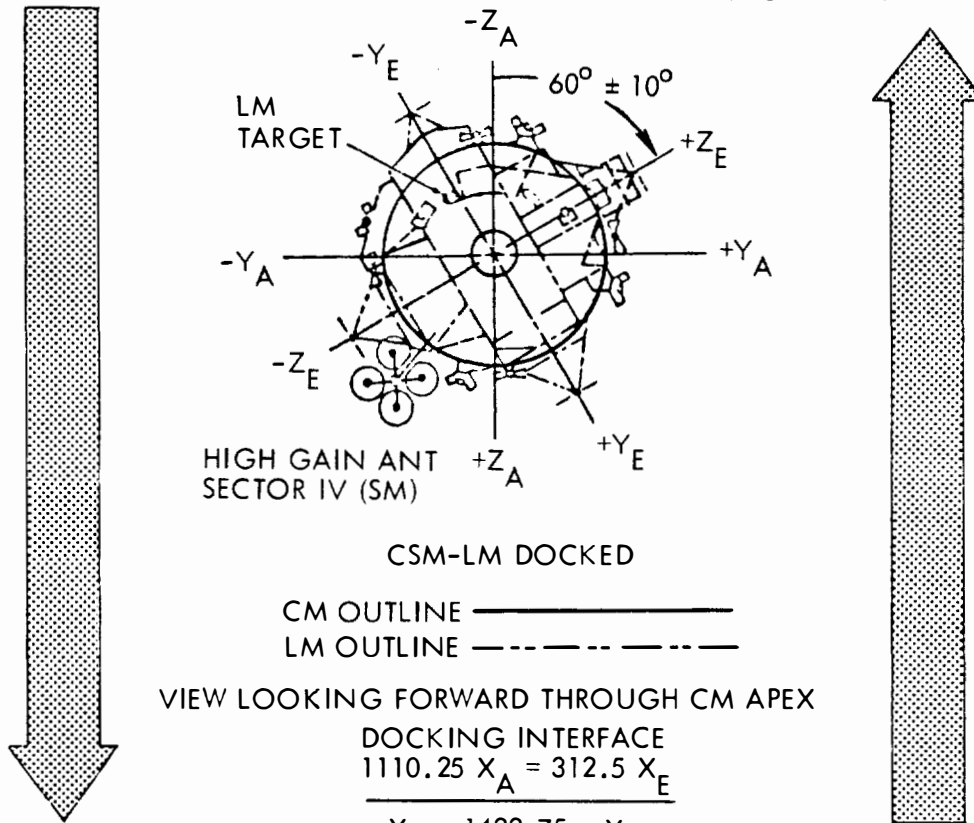

TRANSPOSE USING 180°
POSITIVE PITCH

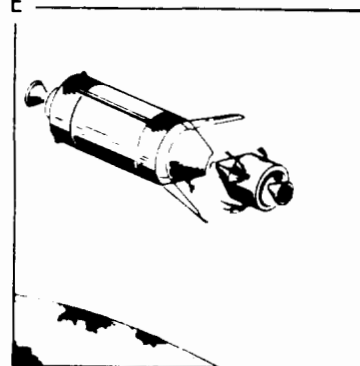
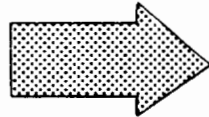

CLOSE AND
ALIGN

Figure 2-11. CSM/LM DOCKED

2-12

SNA-8-D-027 (III) REV 2



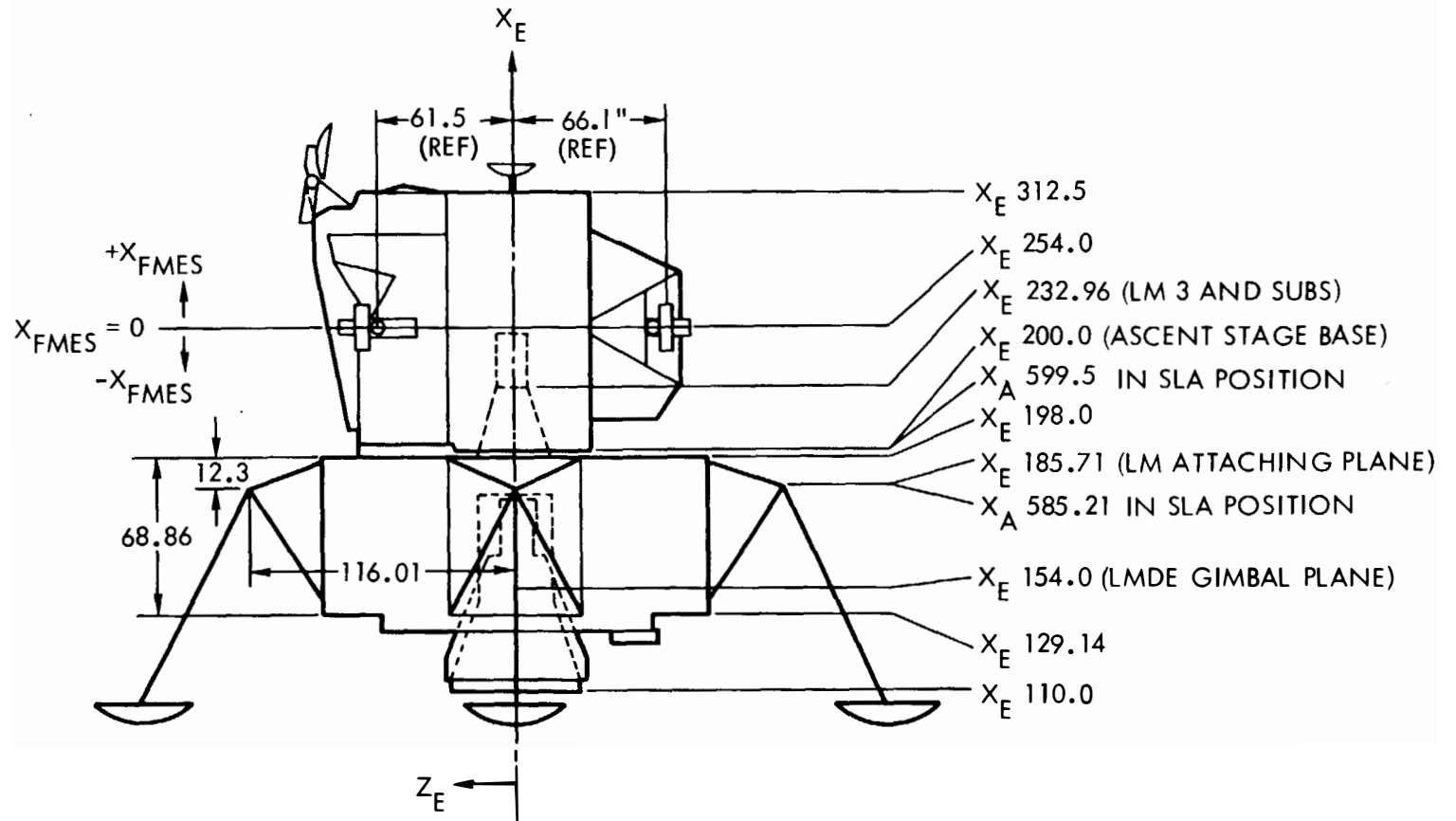

NOTE: X_E = LM COORDINATE SYSTEM
 X_A = APOLLO SPACECRAFT COORDINATE SYSTEM
 ALL LINEAR DIMENSIONS ARE IN INCHES
 RCS PITCH AND ROLL JETS Z_E AND Y_E = ±66.1 (EFFECTIVE GEOMETRIC MOMENT ARM)
 RCS YAW JETS Z_E AND Y_E = ±61.5 (EFFECTIVE GEOMETRIC MOMENT ARM)

Figure 2-12. LM REFERENCE DIMENSIONS

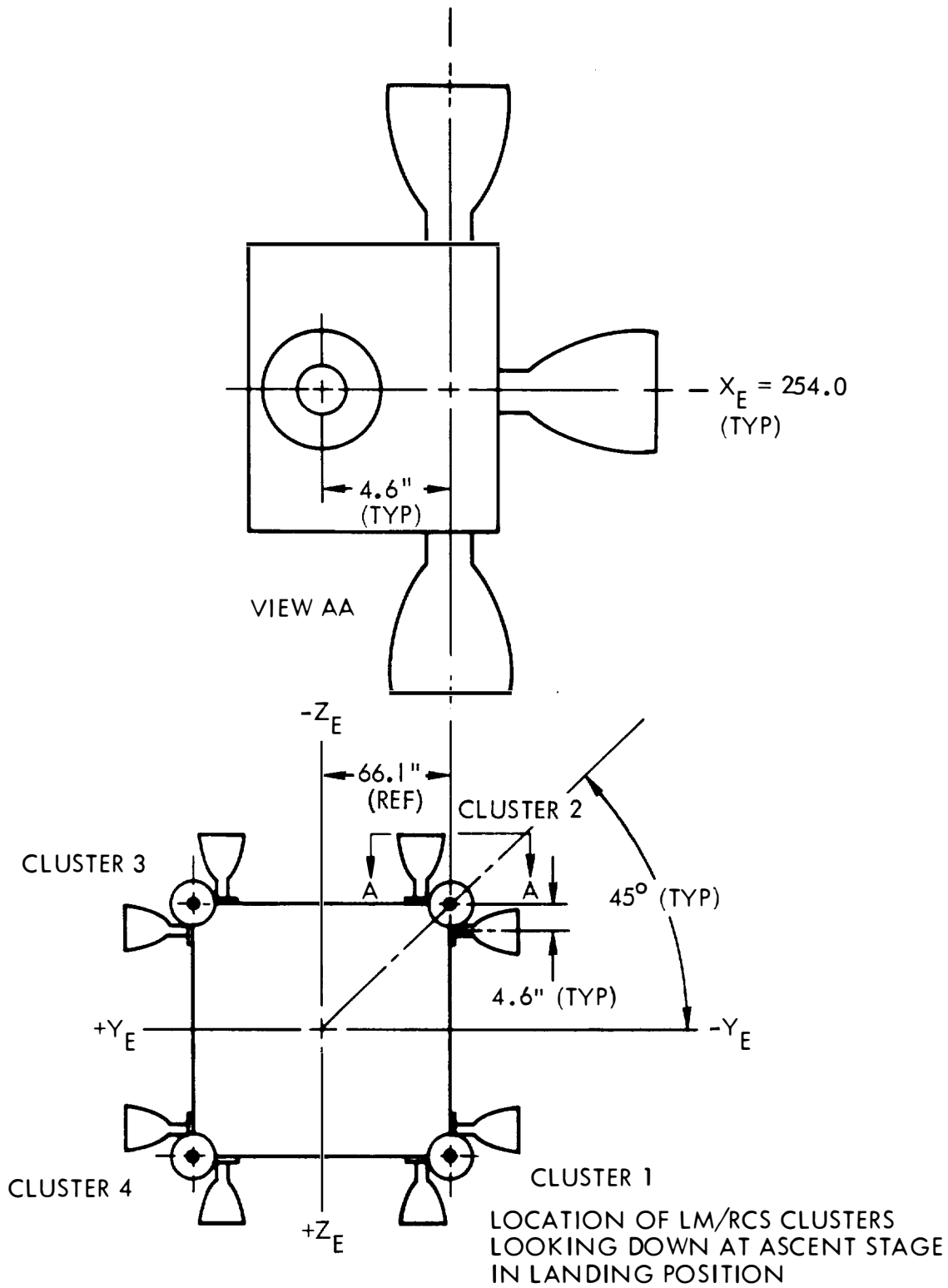
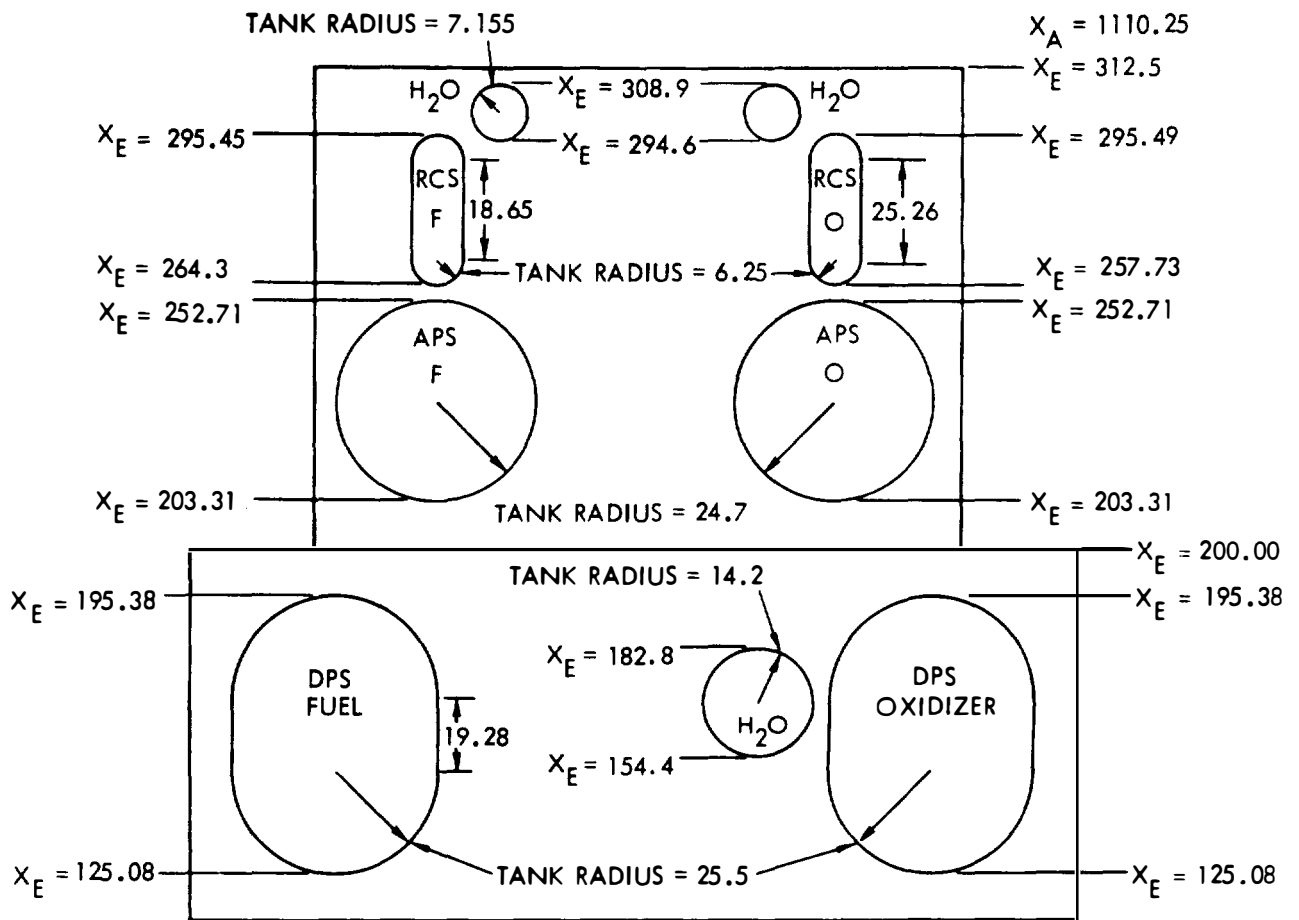

Figure 2-13. LM/RCS THRUST CHAMBER LOCATIONS

U U U E E E E L L L E E U U U E E L E

	Y_E	Z_E
A/S WATER (2)	±25.0	±13.7
D/S WATER (1)	-43.2	-43.2
DPS FUEL (2)	±54.0	0.0
DPS OXIDIZER (2)	0.0	±54.0
APS FUEL (1)	-71.3	0.0
APS OXIDIZER (1)	+44.5	0.0
RCS FUEL (2)	±44.5	±14.5
RCS OXIDIZER (2)	±44.5	±14.5



(NOT TO SCALE)

Figure 2-14

LM-8 PROPELLANT TANK LOCATIONS IN LM (X_E) COORDINATE SYSTEM
(See Figure 2-18 for LM-10 and Subsequent)



(GDA) Actuator Response	Rotation of Engine	Commanded Change Vehicle Angular Acceleration
Extend	$-\delta\theta$	+
Contract	$+\delta\theta$	-
Contract	$-\delta\psi$	+
Extend	$+\delta\psi$	-

} Pitch
 } Pitch
 } Roll
 } Roll

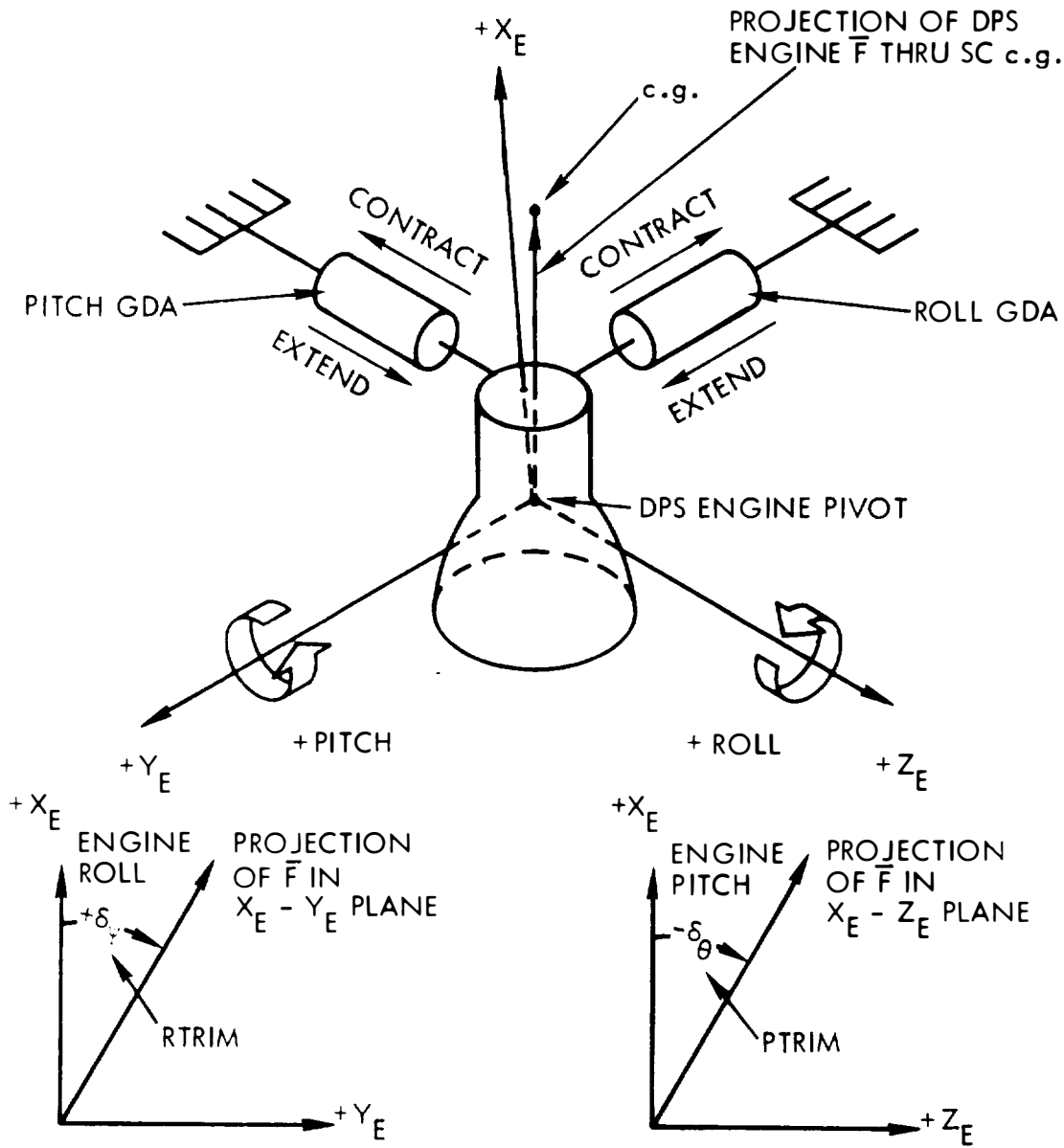

+ OR - SIGN ACCORDING TO ENGINE GIMBAL ANGLE SIGN CONVENTION

Figure 2-15. **SIGN CONVENTION FOR DPS GIMBAL ANGLE**

U U U E E E E E E E E E E E E E E E E

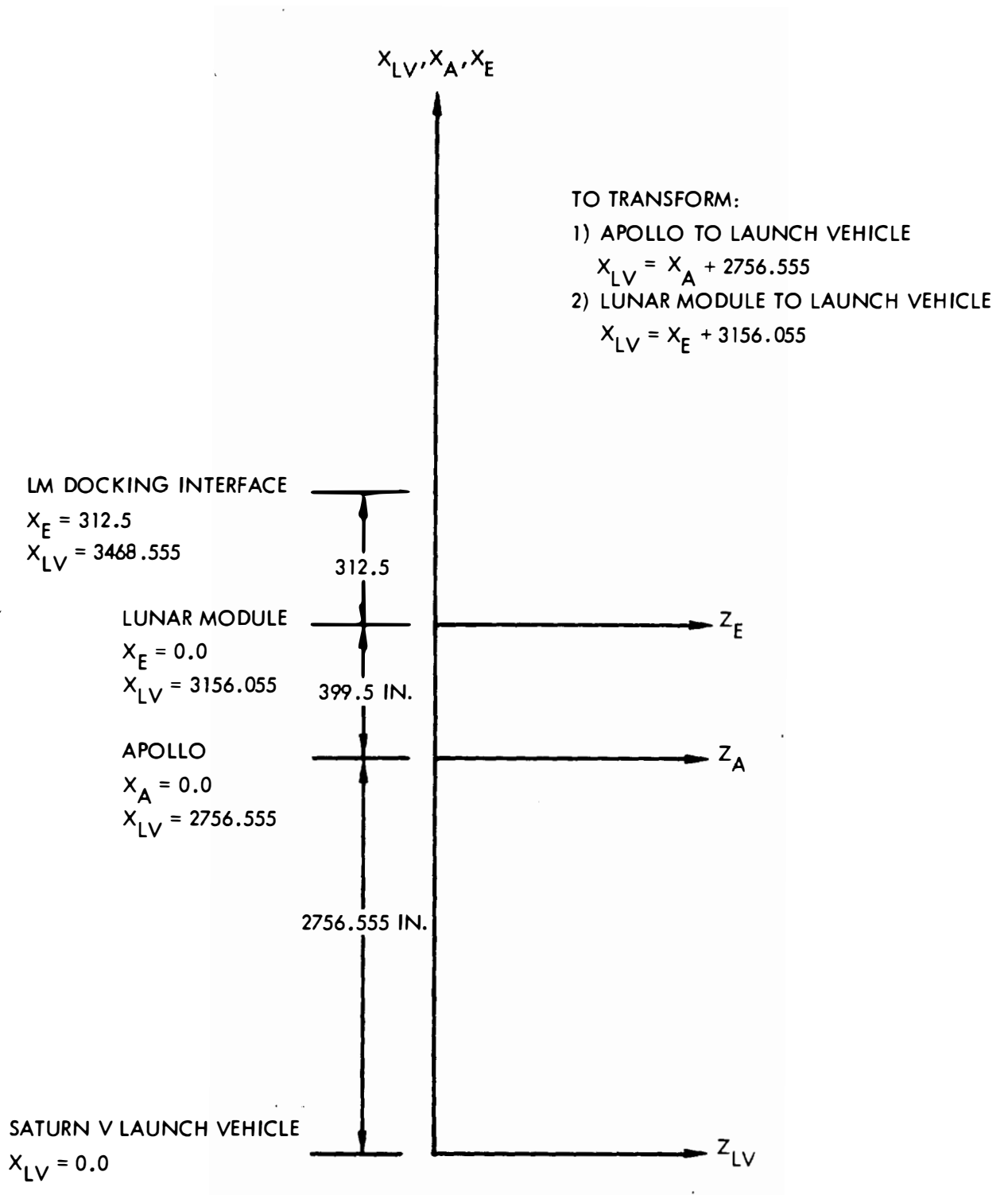
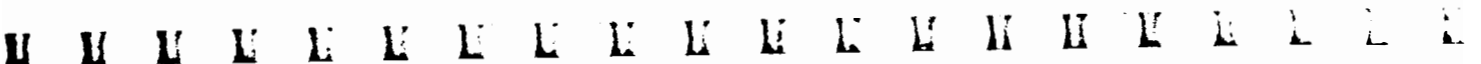

Figure 2-16. Launch Configuration Station Reference



TO TRANSFORM:

1) LAUNCH VEHICLE TO APOLLO

$$X_A = 4578.805 - X_{LV}$$

APOLLO

$$X_A = 0.0$$

$$X_{LV} = 4578.805$$

LM DOCKING INTERFACE

$$X_E = 312.5$$

$$X_{LV} = 3468.555$$

312.5 IN.

LUNAR MODULE

$$X_E = 0.0$$

$$X_{LV} = 3156.055$$

1110.25 IN.

CM DOCKING INTERFACE

$$X_A = 1110.25$$

$$+X_A$$

$$+X_E$$

Z_E

Figure 2-17. Docked CSM/LM Station Reference

M M M M E E E E E E E E E E E E E E E E

	Y_E	Z_E
A/S WATER (2)	± 25.0	± 13.7
D/S WATER (2)	± 43.2	± 43.2
DPS FUEL (2)	± 54.0	0.0
DPS OXIDIZER (2)	0.0	± 54.0
APS FUEL (1)	-71.3	0.0
APS OXIDIZER (1)	+44.5	0.0
RCS FUEL (2)	± 44.5	± 14.5
RCS OXIDIZER (2)	± 44.5	∓ 14.5

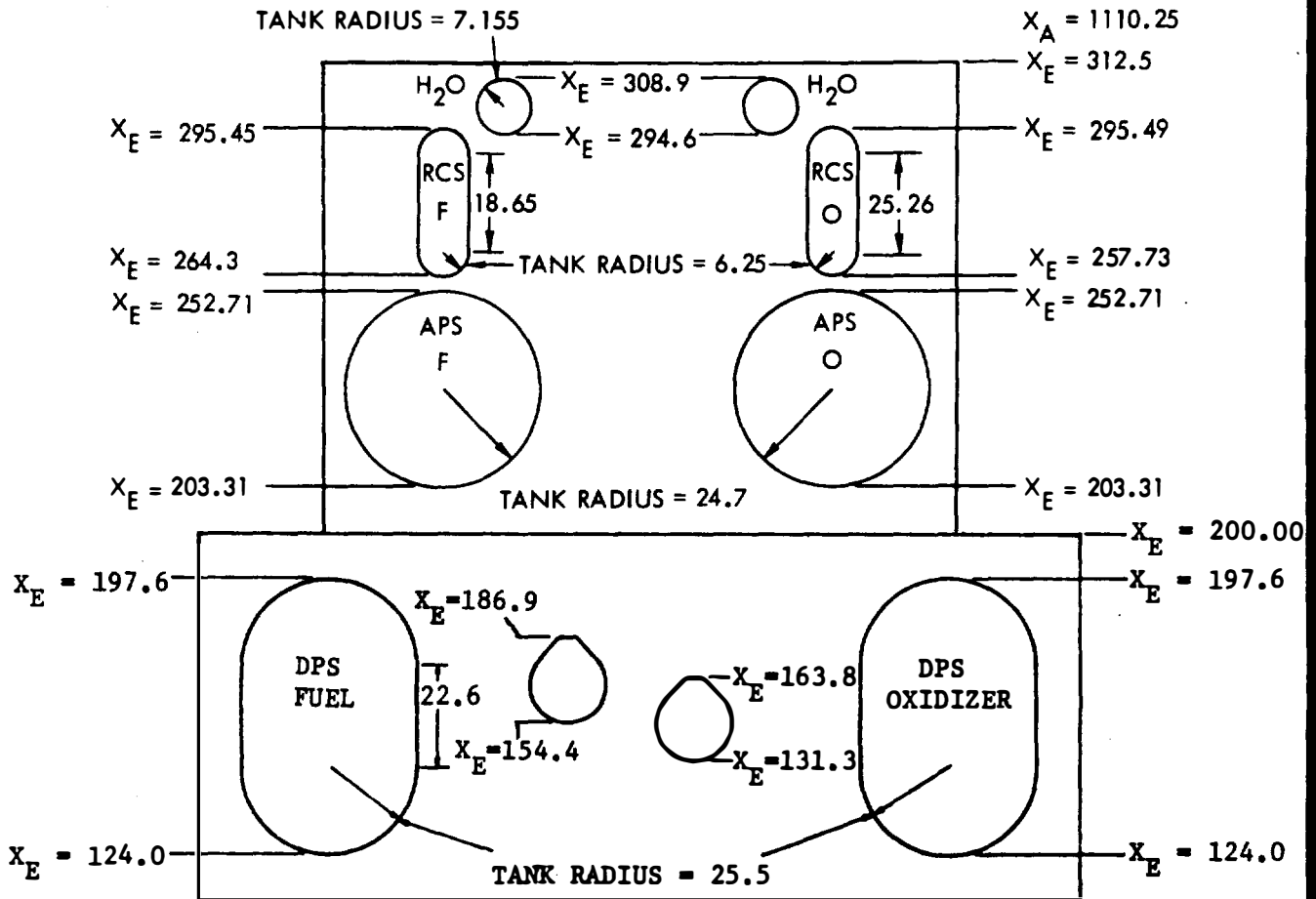

(NOT TO SCALE)

Figure 2-18

LM-10 AND SUBSEQUENT PROPELLANT TANK LOCATIONS IN LM (X_E) COORDINATE SYSTEMS

U U

U U U U U U U U U U U U U U U U U U

V V V V V V V V V V V V V V V V V V

3.0 MISSION MASS
PROPERTIES & LOADING
DATA

A R R R R R R R R R R R R R R R R R R

L L L L L L L L L L L L L L L L L L

M M M M M M M M M M M M M M M M M M



7 0 7 7 7 7 7 7 7 7 7 7 7 7 7 7 7

7 7 7 7 7 7 7 7 7 7 7 7 7 7 7 7 7

7 7 7 7 7 7 7 7 7 7 7 7 7 7 7 7 7

3.1 MISSION G
(CSM 107/LM 5)

7 7 7 7 7 7 7 7 7 7 7 7 7 7 7 7 7

7 7 7 7 7 7 7 7 7 7 7 7 7 7 7 7 7

3.0 SPACECRAFT MASS PROPERTIES AND LOADING DATA BY MISSION

The mass property data specified in this section represent the best prediction of launch configuration mass properties for each spacecraft. The data have been organized logically by Apollo mission and the tables have been organized according to basic mission profile. In addition, data are presented by individual and composite spacecraft to reflect the variation of centers-of-gravity, moments of inertia, and products of inertia as a function of spacecraft weight to enable the user to reasonably predict spacecraft mass properties at any time in the mission profile.

These data represent the composite results of the detailed mass properties data supplied to NASA (MSC-ASPO) by the contractors. Spacecraft mass property data are presented as follows:

1. Section 3.1 Mission G
2. Section 3.2 Mission H1
3. Section 3.3 Mission H2
4. Section 3.4 Mission H3
5. Section 3.5 Mission J1

U U

U U

SUPPLEMENTARY DATA APPLICABLE TO SEQUENTIAL MASS PROPERTIES TABLES

General Comments to be applied to Tables 3.1-1 through 3.1-8:

Inertia data dispersions are $\pm 10\%$.

Dispersions shall be used as 3σ deviation values.

All initial propellant weights are total tanked.

The (+) or (-) sign following the name of an item indicates that the item is added to or subtracted from the preceding total.

Table 3.1-1

SM/SPS gimbal angles for SPS abort sequence are: Pitch = -0.524
Yaw = 1.895

Table 3.1-2

LM propellants are in high end of the tanks, (greatest X-c.g. station), for all docked configuration where the CSM is the controlling vehicle. The Mass Spectrometer and Gamma-Ray Spectrometer are shown deployed after each SPS firing following D.O.I. For all other summations the M.S. and G. R. Spectrometers are not deployed. The following are the individual mass properties for the M.S. and G.R. Spectrometers in Apollo Coordinates.

	Weight (lb)	X-Bar (in)	Y-Bar (in)	Z-Bar (in)
Gamma-Ray Retracted	45.4	865.1	33.0	-57.0
Gamma-Ray Deployed	28.0 17.4	865.1 865.1	231.3 132.2	-312.4 -184.7
Mass Spectrometer Retracted	47.4	863.1	55.8	-40.5
Mass Spectrometer Deployed	27.4 20.0	863.1 863.1	341.7 198.8	-149.4 -94.9

Tables 3.1-7 and 3.1-8

CSM and LM consumables changes are presented in Tables 3.1-7 and 3.1-8, respectively.

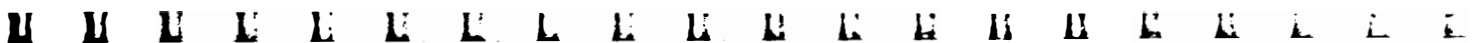

U
 N
 I
 T
 E
 D
 S
 T
 A
 T
 E
 S
 N
 A
 T
 I
 O
 N
 A
 L
 S
 P
 A
 C
 E
 A
 D
 M
 I
 N
 I
 S
 T
 R
 A
 T
 I
 O
 N

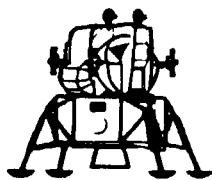

Amendment 110
7/19/71

XE COORDINATES
TABLE 3.1-1
LM-10 EXPECTED SEQUENTIAL MASS PROPERTIES

DESCRIPTION	S	WEIGHT POUNDS	C. G. INCHES			INERTIAS SLUG-FT ²			PRODUCTS SLUG-FT ²			DISPERSIONS LB/IN			
			X	Y	Z	I _{XX}	I _{YY}	I _{ZZ}	P _{XY}	P _{XZ}	P _{YZ}	D _W	D _X	D _Y	D _Z
ASCENT STAGE	+	4744.3	257.4	-0.3	2.8	2760	2669	1570	61	111	-18	25.0	0.0	0.5	0.5
34 LM RCS FUEL	+	102.4	279.1	44.6	14.5	0	0	0	0	0	0	1.0	0.0	0.1	0.1
37 LM RCS FUEL	+	102.4	279.1	-44.6	-14.5	0	0	0	0	0	0	1.0	0.0	0.1	0.1
28 LM RCS OXY	+	200.3	275.4	44.6	14.5	0	1	1	0	0	0	2.0	0.0	0.1	0.1
31 LM RCS OXY	+	200.3	275.4	44.6	-14.5	0	1	1	0	0	0	2.0	0.0	0.1	0.1
22 LM APS FUEL	+	2005.5	228.0	-71.3	0.0	0	0	0	0	0	0	8.4	0.0	0.5	0.5
19 LM APS OXY	+	3217.3	228.0	44.5	0.0	0	0	0	0	0	0	8.7	0.0	0.5	0.5
ASCENT STAGE		10572.5	244.0	-0.1	1.3	6627	3317	6022	57	150	-96	27.2	0.6	0.3	0.3
DESCENT STAGE	+	6180.0	156.4	2.6	-7.7	6805	4825	3750	139	-91	262	25.0	0.0	0.5	0.5
77 LM DPS FUEL	+	3755.1	160.4	54.0	0.0	0	7	7	0	0	0	7.1	0.0	0.5	0.5
80 LM DPS FUEL	+	3755.1	160.4	-54.0	0.0	0	7	7	0	0	0	7.1	0.0	0.5	0.5
71 LM DPS OXY	+	5987.5	160.4	0.0	54.0	0	13	13	0	0	0	12.7	0.0	0.5	0.5
74 LM DPS OXY	+	5987.5	160.4	0.0	-54.0	0	13	13	0	0	0	12.7	0.0	0.5	0.5
DESCENT STAGE		25665.2	159.4	0.6	-1.8	19215	12481	8543	129	-60	242	32.4	0.5	0.2	0.2
LM AT EARTH LAUNCH		36237.7	184.1	0.4	-0.9	25859	27364	26117	87	515	192	42.3	0.4	0.2	0.2

3.1-2

SNA-8-D-027(III) REV 3

U
 N
 I
 T
 E
 D
 S
 T
 A
 T
 E
 S
 S
 P
 A
 C
 E
 A
 D
 M
 I
 N
 I
 S
 T
 R
 A
 T
 I
 O
 N
 S

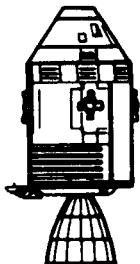

XA COORDINATES
 TABLE 3.1-2
 CSM 112/LM10 EXPECTED SEQUENTIAL MASS PROPERTIES

Amendment 110
 7/19/71

DESCRIPTION	S	WEIGHT POUNDS	C. G. INCHES			INERTIAS SLUG-FT ²			PRODUCTS SLUG-FT ²			DISPERSIONS LB/IN			
			X	Y	Z	IXX	IYY	IZZ	PXY	PKZ	PVZ	OX	OY	OZ	
SLA RING	+	98.0	835.7	2.0	-6.6	120	65	56	0	0	0	.0	.0	.0	.0
SERVICE MODULE	+	13461.0	917.7	1.5	1.3	9695	14386	13095	-194	520	-1657	25.0	1.0	.5	.5
COMMAND MODULE	+	12868.5	1041.0	-.1	5.6	5915	5443	4895	53	-415	-7	25.0	1.0	.5	.5
CSM LESS SPS PROPELLANT		26427.5	977.4	.7	3.4	15762	41937	40064	-424	887	-1674	35.4	.7	.4	.4
43 SM SPS F-STORE	+	6716.7	903.6	-14.8	-47.8	0	1880	1880	0	0	0	59.0	1.0	.5	.5
46 SM SPS O-STORE	+	10712.5	903.6	14.8	47.8	0	2997	2997	0	0	0	121.0	1.0	.5	.5
49 SM SPS F-SUMP	+	8868.7	906.8	-48.3	-6.6	0	2608	2608	0	0	0	59.0	1.0	.5	.5
52 SM SPS O-SUMP	+	14199.4	907.0	48.3	6.6	0	4210	4210	0	0	0	121.0	1.0	.5	.5
SM WITH SPS PROPELLANT		54056.3	908.4	6.2	4.5	30389	35191	37301	-269	359	2269	192.0	.5	.3	.3
CSM AT EARTH LAUNCH		66924.8	933.9	5.0	4.7	36397	80079	81729	-2101	272	2297	193.6	.4	.2	.2

3.1-3

SNA-8-D-027(III) REV 3

U
N
I
T
E
D
S
T
A
T
E
S
O
F
A
M
E
R
I
C
A
S
P
A
C
E
S
H
I
P
C
O
M
M
A
N
D
A
N
D
C
O
N
T
R
O
L
C
E
N
T
E
R
A
S
T
R
O
N
A
U
T
I
C
S
Y
S
T
E
M
S
C
O
M
M
A
N
D
A
N
D
C
O
N
T
R
O
L
C
E
N
T
E
R

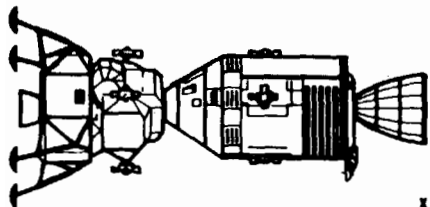

Amendment 110
7/19/71

XA COORDINATES TABLE 3.1-2 (CONTINUED)
CSM/LM10 EXPECTED SEQUENTIAL MASS PROPERTIES

DESCRIPTION	S	WEIGHT POUNDS	C. G. INCHES			INERTIAS SLUG-FT ²			PRODUCTS SLUG-FT ²			DISPERSIONS LB/IN			
			X	Y	Z	IXX	IYY	IZZ	PXY	PXZ	PYZ	DX	DY	DZ	
CSM/LM PRE D.O.I.		76340.9	1083.7	1.9	2.0	48348	442949	449052	-8707	-1214	-1018	198.2	.7	.2	.2
CSM/LM POST D.O.I.		74779.5	1087.1	1.7	2.0	47560	433577	438921	-8183	-1239	-1118	198.2	.7	.2	.2
DEPLOY M.S. AND G.R.		74779.5	1087.1	2.0	1.8	49674	434429	440115	-9049	-593	-1990	198.2	.7	.2	.2
2 CREW+EQUIP, CM-LM	-	511.2	1091.8	13.7	-12.2	26	9	25	-3	3	-3	.0	.0	.0	.0
EQUIP.XFR, LM-CM 1	+	1.1	1018.0	24.5	-15.0	0	0	0	0	0	0	.0	.0	.0	.0
CM EQUIP.RELOC.2	-	174.3	1017.3	-3.2	-18.6	11	12	11	-2	2	-1	.0	.0	.0	.0
CM EQUIP.RELOC.2	+	174.3	1091.8	-.7	-14.9	18	4	15	0	1	2	.0	.0	.0	.0
LANDING GEAR UP	-	486.0	1308.0	1.1	-.7	732	445	453	-5	3	-4	.0	.0	.0	.0
LANDING GEAR DOWN	+	486.0	1304.5	1.3	-.8	1958	1052	1060	-9	5	-7	.0	.0	.0	.0
2 CREW+EQUIP, CM-LM	+	511.2	1170.8	34.7	-20.0	64	50	20	0	2	17	.0	.0	.0	.0
LM EQUIP.RELOC.1	-	18.5	1155.0	46.9	-24.0	0	0	0	0	0	0	.0	.0	.0	.0
LM EQUIP.RELOC.1	+	18.5	1142.3	-3.4	3.4	1	0	1	0	0	0	.0	.0	.0	.0
EQUIP.XFR, LM-CM 1	-	1.1	1122.7	.0	-.0	0	0	0	0	0	0	.0	.0	.0	.0
CSM/LM AT SEPARATION		74610.8	1088.3	1.9	1.9	48800	433516	438911	-7867	-1517	-1121	198.2	.7	.2	.2

3.1-5

SMA-8-D-027(111) REV 3

U
 N
 I
 T
 E
 D
 S
 T
 A
 T
 E
 S
 S
 P
 A
 C
 E
 A
 D
 M
 I
 N
 I
 S
 T
 R
 A
 T
 I
 O
 N
 S

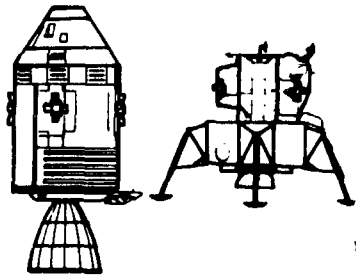

YA COORDINATES
 TABLE 3.1-2(CONTINUED)
 CSM 112/LM10 EXPECTED SEQUENTIAL MASS PROPERTIES

Amendment 110
7/19/71

DESCRIPTION	S	WEIGHT POUNDS	C. G. INCHES			INERTIAS SLUG-FT ²			PRODUCTS SLUG-FT ²			DISPERSIONS LB/IN			
			X	Y	Z	IXX	IYY	IZZ	PXY	PRZ	PVZ	DX	DY	DZ	
CSM PRE CIRC. BURN		17851.3	944.0	3.9	3.3	21373	60071	64427	-2408	1359	-650	193.6	.7	.3	.3
CSM POST CIRC. BURN		37573.4	944.2	3.8	3.3	21235	60021	64244	-2395	1356	-668	193.6	.7	.3	.3
DEPLOY M.S. AND G.R.		37573.4	944.2	4.3	2.9	23269	60880	65421	-2706	1587	-1538	193.6	.7	.3	.3
CSM PRE PLANE CHANGE 1		37333.4	944.3	3.9	3.2	21055	59883	64140	-2412	1378	-611	193.6	.7	.3	.3
CSM POST PLANE CHANGE 1		36199.6	945.4	3.7	3.3	20490	59601	63315	-2347	1362	-681	193.6	.8	.3	.3
DEPLOY M.S. AND G.R.		36199.6	945.4	4.2	2.9	22525	60459	64493	-2663	1597	-1552	193.6	.8	.3	.3
CSM AT ASCENT STAGE DOCKING		36107.0	945.5	3.7	3.3	20391	59541	63267	-2344	1369	-656	193.6	.8	.3	.3
ASCENT STAGE AT DOCKING		5730.6	1165.2	4.7	-2.6	3263	2274	2662	-110	-11	-399	27.2	.8	.6	.2
CSM/ASCENT STAGE MANNED		41837.6	975.6	3.8	2.5	23692	113412	117490	-2227	-28	-1061	195.5	.8	.3	.3

3.1-6

SMA-B-D-027(III) REV 3

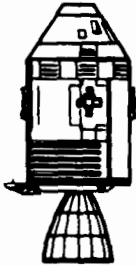

XA COORDINATES TABLE 3.1-2 (CONTINUED)
CSM 1,2/LM10 EXPECTED SEQUENTIAL MASS PROPERTIES

DESCRIPTION	S	WEIGHT POUNDS	C. G. INCHES			INERTIAS SLUG-FT ²			PRODUCTS SLUG-FT ²			DISPERSIONS LB/IN			
			X	Y	Z	IXX	IYY	IZZ	PXY	PXZ	PYZ	DX	DY	DZ	
CM EQUIP.RELOC.4	-	172.5	1019.0	4.2	-23.7	24	21	15	-2	5	-9	.0	.0	.0	.0
CM EQUIP.RELOC.4	+	172.5	1042.0	-.9	-14.9	18	4	15	0	1	2	.0	.0	.0	.0
CSM PRE EVA		26656.8	971.6	1.2	3.7	15443	45064	44222	-772	853	-1200	193.6	1.2	.4	.4
EQUIP.XFR. SM-CM	-	94.3	931.4	38.9	-53.3	1	13	14	-4	0	0	.0	.0	.0	.0
EQUIP.XFR. SM-CM	+	94.3	1020.2	-23.2	15.3	3	9	5	0	4	0	.0	.0	.0	.0
EVA OFFLOAD	-	32.6	1047.8	-26.7	37.3	0	0	0	0	0	0	.0	.0	.0	.0
CSM POST EVA		26624.2	971.8	1.0	3.9	15351	44962	44164	-747	803	-1156	193.6	1.2	.4	.4
CM EQUIP.RELOC.5	-	255.1	1033.6	-1.5	-15.7	29	20	27	0	0	1	.0	.0	.0	.0
CM EQUIP.RELOC.5	+	255.1	1020.9	5.6	-8.2	13	10	14	0	0	-3	.0	.0	.0	.0
CSM W/PGA STORED		26624.2	971.7	1.1	4.0	15322	44861	44075	-726	836	-1167	193.6	1.2	.4	.4
DEPLOY H.S. AND G.R.		26624.2	971.7	1.8	3.5	17380	45723	45271	-1144	1147	-2047	193.6	1.2	.4	.4
CSM PRE CM/SM SEPARATION		26371.4	972.1	1.2	4.0	15133	44626	43874	-743	865	-1109	193.6	1.2	.4	.4
SM POST CM/SM SEPARATION		13447.6	907.7	2.2	2.2	9184	14753	14557	-408	583	-1086	192.0	1.4	.7	.7

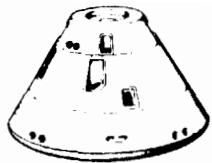

XA COORDINATES TABLE 3.1-2(Continued)
CSM 112/LM10 EXPECTED SEQUENTIAL MASS PROPERTIES

Amendment 110
7/19/71

DESCRIPTION	S	WEIGHT POUNDS	C. G. INCHES			INERTIAS SLUG-FT ²			PRODUCTS SLUG-FT ²			DISPERSIONS LB/IN			
			X	Y	Z	IXX	IYY	IZZ	PXY	PXZ	PYZ	DX	DY	DZ	
CM POST CM/SM SEPARATION		12923.8	1039.1	.1	5.8	5924	5280	4737	61	-389	-11	25.0	1.0	.5	.5
CM AT ENTRY		12912.2	1039.1	.1	5.7	5917	5273	4736	61	-387	-10	25.0	1.0	.5	.5
ABLATOR BURNOFF	-	150.0	1031.1	.0	7.4	103	81	78	0	0	0	.0	.0	.0	.0
ENTRY COOLING	-	2.0	1022.6	-19.7	62.5	0	0	0	0	0	0	.0	.0	.0	.0
FWD HEAT SHIELD	-	310.0	1094.3	-.5	.8	64	26	23	0	0	0	.0	.0	.0	.0
DROGUE+DISCONNECTS	-	80.0	1089.0	.0	-23.9	1	1	0	0	0	0	.0	.0	.0	.0
CM AT MAIN CHUTE DEPLOY		12339.5	1037.6	.1	5.9	5712	4873	4377	62	-336	-8	25.0	1.0	.5	.5
PILOT CHUTE+RISERS	-	45.5	1089.9	5.9	-5.8	2	2	1	0	0	0	.0	.0	.0	.0
MAIN CHUTE	-	401.4	1089.1	.4	8.5	62	22	43	0	0	0	.0	.0	.0	.0
CM RCS DUMP	-	202.7	1022.6	-7.3	57.0	0	0	0	0	0	0	.0	.0	.0	.0
CM AT IMPACT		11689.9	1035.9	.2	5.0	5527	4456	4056	53	-312	9	25.0	1.1	.4	.6

3.1-10

SNA-8-D-027(III) REV 3

U
 N
 I
 T
 E
 D
 S
 T
 A
 T
 E
 S
 S
 P
 A
 C
 E
 A
 D
 M
 I
 N
 I
 S
 T
 R
 A
 T
 I
 O
 N
 S

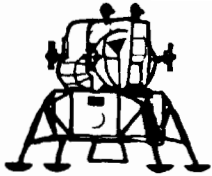

Amendment 110
7/19/71

XE COORDINATES TABLE 3.1-3
 LM-10 EXPECTED SEQUENTIAL MASS PROPERTIES

DESCRIPTION	S	WEIGHT POUNDS	C. G. INCHES			INERTIAS SLUG-FT ²			PRODUCTS SLUG-FT ²			DISPERSIONS LB/IN			
			X	Y	Z	IXX	IYY	IZZ	PXY	PAZ	PYZ	DX	DY	DZ	
LM AT EARTH LAUNCH		36237.7	184.1	.4	-.9	25859	27364	26117	87	515	192	42.3	.4	.2	.2
LANDING GEAR UP	-	486.0	114.8	.0	1.3	732	457	442	0	6	0	.0	.0	.0	.0
LANDING GEAR DOWN	+	486.0	118.3	.0	1.5	1958	1065	1048	0	11	0	.0	.0	.0	.0
LM CABLING	-	2.7	209.7	88.8	-29.0	0	0	0	0	0	0	.0	.0	.0	.0
CM GASEOUS O ₂	+	5.5	254.0	.0	15.0	0	0	0	0	0	0	.0	.0	.0	.0
2 CREW+EQIP, CM-LM	+	511.2	252.0	-.0	40.1	64	13	57	-2	0	-4	.0	.0	.0	.0
LM EQUIP. RELOC. 1	-	18.5	267.8	2.7	52.6	0	0	0	0	0	0	.0	.0	.0	.0
LM EQUIP. RELOC. 1	+	18.5	280.4	1.3	-4.6	1	1	0	0	0	0	.0	.0	.0	.0
EQUIP. XFR. LM-CM 1	-	1.1	300.0	.0	.0	0	0	0	0	0	0	.0	.0	.0	.0
LM AT SEPARATION		36732.6	185.1	.4	-.4	27305	28601	27216	81	807	182	42.3	.4	.2	.2
LM PRE P.O.I.		36658.3	185.0	.4	-.4	27262	28465	27061	84	809	175	42.3	.4	.2	.2

3.1-11

SMA-8-D-027(III) REV 3

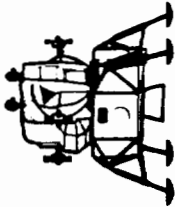

Amendment 110
7/19/71

KE COORDINATES
LM-10 EXPECTED SEQUENTIAL MASS PROPERTIES

DESCRIPTION	S	WEIGHT POUNDS	C. G. INCHES			INERTIALS SLUG-FT ²			PRODUCTS SLUG-FT ²			DISPERSIONS LM/IN			
			X	Y	Z	IXX	IYY	IZZ	PXY	PYZ	PZY	DX	DY	DZ	
DESCENT ABLATION	-	29.0	145.4	.0	.0	0	0	0	0	0	0	0	.0	.0	.0
HELIUM TRANSFER	-	51.2	148.5	47.2	-47.2	0	0	0	0	0	0	0	.0	.0	.0
HELIUM TRANSFER	+	51.2	158.7	8.5	-8.1	0	0	0	0	0	0	0	.0	.0	.0
LM AT TOUCHDOWN		17746.7	210.2	.7	-.6	15343	16120	17411	41	847	203	42.3	.5	.2	.3
ASCENT STAGE AT TOUCHDOWN		10939.7	243.8	-.1	3.0	6768	3424	5963	56	182	-42	27.2	.6	.3	.3
LEFT AT LUNAR SITE	-	326.4	244.8	-6.6	21.7	57	69	49	-8	-24	7	.0	.0	.0	.0
ONLOAD AT LUN. SITE	+	240.8	250.5	-7.4	9.5	48	44	41	-2	-16	10	.0	.0	.0	.0
LM EQUIP. RELOC. 2	-	119.7	250.5	-14.6	8.6	17	20	11	-3	-8	5	.0	.0	.0	.0
LM EQUIP. RELOC. 2	+	119.7	239.7	-1.8	28.4	18	32	20	-1	-15	2	.0	.0	.0	.0
ASCENT STAGE AT LIFTOFF		10849.1	243.8	.1	2.8	6744	3405	5955	65	180	-35	27.2	.6	.3	.3
A/S ABLATION	-	10.0	220.2	.0	.0	0	0	0	0	0	0	.0	.0	.0	.0
ASCENT STAGE IN ORBIT		5896.4	257.0	.1	5.2	3346	2899	2081	65	93	-35	27.2	.6	.4	.4

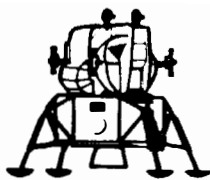

AE COORDINATES

TABLE 3.1-3 (CONTINUED)
LM-10 CONTINGENCY LUNAR LIFTOFF MASS PROPERTIES

DESCRIPTION	S	WEIGHT POUNDS	C. G. INCHES			INERTIAS SLUG-FT ²			PRODUCTS SLUG-FT ²			DISPERSIONS LB/IN			
			X	Y	Z	I _{XX}	I _{YY}	I _{ZZ}	P _{XY}	P _{XZ}	P _{YZ}	D _W	D _X	D _Y	D _Z
ASCENT STAGE AT TD	+	10939.7	243.8	-0.1	3.0	6768	3424	5963	56	182	-42	.0	.0	.0	.0
PNE SEVA REARRANGE	-	132.4	223.4	.5	41.0	11	9	5	0	-2	0	.0	.0	.0	.0
PNE SEVA REARRANGE	+	136.9	228.6	.8	31.7	15	25	13	0	-9	0	.0	.0	.0	.0
PNE SEVA LIFTOFF		10944.2	243.9	-0.1	2.9	6754	3417	5966	55	184	-42	.0	.0	.0	.0
ASCENT STAGE AT TD	+	10939.7	243.8	-0.1	3.0	6768	3424	5963	56	182	-42	.0	.0	.0	.0
CHEM METABOLIC ACT	+	26.6	239.6	-9.7	36.8	0	0	0	0	0	0	.0	.0	.0	.0
PRE EVA 1 REARRANG	-	290.6	238.7	-4.7	21.6	57	67	38	-7	-28	12	.0	.0	.0	.0
PRE EVA 1 REARRANG	+	290.6	244.0	-2.4	21.0	38	62	38	-4	-25	5	.0	.0	.0	.0
PNE EVA 1 LIFTOFF *		10966.3	243.9	-0.1	3.1	6754	3422	5960	58	190	-48	.0	.0	.0	.0

* Assumes PLSS's charged

See pages 3.1-120 through 3.1-120.25 for crew metabolic activity and equipment details.

3.1-14

SNA-8-D-027(III) REV 3

P
 H
 E
 N
 T
 R
 Y
 R
 E
 P
 O
 R
 T
 N
 O
 .
 3
 1
 -
 1
 4
 .
 1

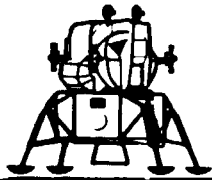

Amendment 111
7/22/71

XE COORDINATES

TABLE 3.1-3 (CONTINUED)
LM-10 CONTINGENCY LUNAR LIFTOFF MASS PROPERTIES

DESCRIPTION	S	WEIGHT POUNDS	C. G. INCHES			INERTIAS SLUG-FT ²			PRODUCTS SLUG-FT ²			DISPERSIONS LB/IN			
			X	Y	Z	IXX	IYY	IZZ	PXY	PXZ	PYZ	DX	DY	DZ	
ASCLNT STAGE AT TD *	+	10939.7	243.8	-0.1	3.0	6768	3424	5963	56	182	-42	.0	.0	.0	.0
CREW METABOLIC ACT *	+	24.5	234.9	-10.5	43.1	0	0	0	0	0	0	.0	.0	.0	.0
EVA 1 OFFLOAD	-	60.7	242.2	8.1	14.0	15	11	7	-1	-1	5	.0	.0	.0	.0
EVA 1 ON LOAD	+	146.7	246.4	-1.0	19.1	37	30	24	-6	-11	11	.0	.0	.0	.0
PRE EVA 2 REARRANG	-	297.7	238.1	-6.9	26.2	56	72	40	-9	-32	12	.0	.0	.0	.0
PRE EVA 2 REARRANG	+	297.7	244.2	-1.7	21.6	39	69	40	-6	-29	7	.0	.0	.0	.0
PRE EVA 2 LIFTOFF *		11050.2	244.0	-0.0	3.1	6772	3440	5974	51	183	-35	.0	.0	.0	.0
ASCENT STAGE AT TD *	+	10939.7	243.8	-0.1	3.0	6768	3424	5963	56	182	-42	.0	.0	.0	.0
CREW METABOLIC ACT *	+	23.6	229.6	-10.9	51.5	0	0	0	0	0	0	.0	.0	.0	.0
EVA 1 OFFLOAD	-	60.7	242.2	8.1	14.0	15	11	7	-1	-1	5	.0	.0	.0	.0
EVA 1 ON LOAD	+	146.7	246.4	-1.0	19.1	37	30	24	-6	-11	11	.0	.0	.0	.0
EVA 2 OFFLOAD	-	59.2	237.2	1.0	36.5	10	11	7	-2	-4	3	.0	.0	.0	.0
EVA 2 ONLOAD	+	118.5	255.9	-6.8	13.5	25	31	18	-4	-14	6	.0	.0	.0	.0
PRE EVA 3 REARRANG	-	249.1	235.4	-7.4	28.0	44	63	32	-8	-25	12	.0	.0	.0	.0
PRE EVA 3 REARRANG	+	249.1	245.4	-2.9	20.5	23	48	30	-2	-19	2	.0	.0	.0	.0
PRE EVA 3 LIFTOFF *		11108.6	244.2	-0.2	3.0	6773	3448	5986	50	183	-41	.0	.0	.0	.0

* Assumes PLSS's charged

See pages 3.1-120 through 3.1-120.25 for crew metabolic activity and equipment details.

3.1-14.1

SNA-8-D-027(III) REV 3

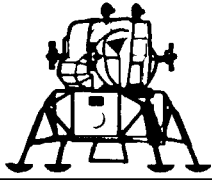

Amendment 111
7/22/71

AE COORDINATES
LM-10 CONTINGENCY LUNAR LIFTOFF MASS PROPERTIES

DESCRIPTION	S	WEIGHT POUNDS	C. G. INCHES			INERTIAS SLUG-FT ²			PRODUCTS SLUG-FT ²			DISPERSIONS LB-IN			
			X	Y	Z	IXX	IYY	IZZ	PXY	PXZ	PYZ	DW	DX	DY	DZ
ASCENT STAGE AT TO	+	10939.7	241.8	-0.1	3.0	6768	3424	5963	56	182	-42	.0	.0	.0	.0
CREW METABOLIC ACT	-	3.2	342.7	-4.1	-133.9	0	0	0	0	0	0	.0	.0	.0	.0
EVA 1 OFFLOAD	-	60.7	242.2	8.1	14.0	15	11	7	-1	-1	5	.0	.0	.0	.0
EVA 1 ON LOAD	+	146.7	246.4	-1.0	19.1	37	30	24	-6	-11	11	.0	.0	.0	.0
EVA 2 OFFLOAD	-	59.2	237.2	1.0	36.5	10	11	7	-2	-4	3	.0	.0	.0	.0
EVA 2 ONLOAD	+	118.5	255.9	-6.8	13.5	25	31	18	-4	-14	6	.0	.0	.0	.0
EVA 3 OFFLOAD	-	101.0	243.3	-4.2	25.6	23	25	15	-1	-8	1	.0	.0	.0	.0
EVA 3 ONLOAD	+	87.9	239.6	-9.5	16.7	16	19	14	1	-5	-1	.0	.0	.0	.0
PRE DEPR REARRANGE	-	243.7	234.7	-11.3	29.5	46	52	34	-3	-23	4	.0	.0	.0	.0
PRE DEPR REARRANGE	+	243.7	240.9	-3.4	24.6	19	31	22	-2	-10	1	.0	.0	.0	.0
PRE DEPRESS LIFTOFF		11068.7	244.1	-0.1	2.9	6729	3391	5965	47	203	-28	.0	.0	.0	.0

3.1-14.2

SNA-B-D-027(III) REV 3

See pages 3.1-120 through 3.1-120.25 for crew metabolic activity and equipment details.

U U B E E C L L E E K E H E E E L L

U
N
I
T
E
D
S
T
A
T
E
S
O
F
A
S
T
A
S
I
A
N
S
P
A
C
E
A
D
M
I
N
I
S
T
R
A
T
I
O
N

Amendment 110
7/19/71

TABLE 3.1-3.1

LRV MASS PROPERTIES								
FIRST TRAVERSE DEPARTURE - TWO CREW						LRV COORDINATES		
DESCRIPTION	STOW. ITEM	REF	NO.	STOWAGE LOCATION	WEIGHT	X-C.G.	Y-C.G.	Z-C.G.
LUNAR ROVER VEHICLE	K1000.		1	DEPLOY ON LUN.SURF.	463.2	53.0	-.3	103.0
S-059 S.E.S.CONTAINER	G4003.2		1	WITHIN ZONE A3 (1)	1.0	98.0	-27.5	120.0
S-059 DRIVE TUBES	G4003.4		3	WITHIN ZONE A3 (1)	1.8	98.0	-27.5	120.0
S-059 CAPS AND DISPENSER	G4003.5		3	WITHIN ZONE A5 (1)	.2	98.0	4.5	120.0
S-059 DRILL STEMS	G4003.6		6	WITHIN ZONE A2 (2)	2.6	131.8	-6.0	118.2
S-059 DRILL STEM CAP+RETAINERS	G4003.7		2	WITHIN ZONE A2 (2)	.3	131.8	-6.0	118.2
S-059 20 BAG D.S.B.DISPENSER	G4003.3A		1	CREW STATION - LEFT	1.1	84.9	-14.5	124.5
S-059 20 BAG C.S.B.DISPENSER	G4003.3B		1	CREW STATION - RIGHT	1.1	84.9	14.5	124.5
S-059 TOOL EXTENSION	G4008.		1	NEAR RH CREW STATION	1.8	86.0	24.5	111.0
S-059 TONGS, 32 INCH	G4009.A		1	WITHIN ZONE A8 (1)	1.0	120.8	-5.4	121.7
S-059 TONGS, 32 INCH	G4009.B		1	WITHIN ZONE B1 (1)	1.0	86.0	-4.5	111.0
S-059 GNOMCN	G4012.		1	WITHIN ZONE A3 (2)	.6	99.2	-19.5	119.8
S-059 LGE TOOL CARRIER	G4035.		1	WITHIN ZONE A2 (1)	13.8	128.2	-2.0	117.3
S-059 SCOOP, ADJ.SAMPLING	G4035.2		1	NEAR RH CREW STATION	.8	86.0	24.5	111.0
S-059 HAMMER	G4035.3		1	WITHIN ZONE A5 (1)	2.8	98.0	4.5	120.0
S-059 TOOL ASSY, DRIVE TUBE	G4035.5		1	WITHIN ZONE A5 (1)	.1	98.0	4.5	120.0
S-200 PENETROMETER, RECORDING	G4049.		1	WITHIN ZONE A8 (3)	5.8	117.2	-19.7	135.5
S-059 RAKE, LUNAR SAMPLING	G4054.		1	WITHIN ZONE A8 (4)	4.3	117.4	-10.7	130.7
MAGAZINE, 16MM DAC	A0101.1		2	WITHIN ZONE B1 (2)	2.0	84.0	-19.0	103.0
MAGAZINE, ELECT.FASS.CAMERA	A0108.1		2	WITHIN ZONE B1 (3)	2.8	86.0	-19.0	103.0
CAMERA, L.S.HASSELBLAD	A1015.		2	BETWEEN CREW STATION	9.0	84.9	.0	124.5
LENS, 60MM	A1016.		2	BETWEEN CREW STATION	3.4	84.9	.0	124.5
TRIGGER, L.S.HASSELBLAD	A1027.		2	BETWEEN CREW STATION	.4	84.9	.0	124.5
HANDLE, L.S.HASSELBLAD	A1027.		2	BETWEEN CREW STATION	1.0	84.9	.0	124.5
BRUSH, LENS	A1042.		2	WITHIN ZONE A3 (5)	.2	120.6	-20.5	117.2
CAMERA, POWER PACK ASSY, 16MM LS	A1043.		1	ZONE D1	9.9	62.0	8.0	139.5
BRACKET, CAMERA MOUNT	B1001.1		2	BETWEEN CREW STATION	1.2	84.9	.0	124.5
STAFF, 16MM CAMERA/PP	R1001.		1	WITHIN ZONE D1 (1)	1.5	62.0	8.0	130.0
70MM CAMERA W/500MM LENS, ETC.	TBD		1	BELOW LH CREW STA	10.7	85.0	-10.5	103.0
TV SYSTEM, LM CCLCR	E1001.1		1	WITHIN ZONE F1 (1)	12.9	12.5	14.3	125.0

3.1-15

SNA-8-D-027(III) REV 3

U
 N
 I
 T
 E
 D
 S
 T
 A
 T
 E
 S
 I
 N
 G
 E
 N
 E
 R
 A
 L
 R
 E
 C
 O
 R
 D
 S

TABLE 3.1-3.1 (CONTINUED)

LRV MASS PROPERTIES								
FIRST TRAVERSE DEPARTURE - TWO CREW								
						LRV COORDINATES		
DESCRIPTION	STOW. ITEM	REF	NO.	STORAGE LOCATION	WEIGHT	X-C.G.	Y-C.G.	Z-C.G.
TV CONTRCL UNIT	E1001.2		1	WITHIN ZONE F1 (1)	12.5	12.5	14.3	125.0
LCRU,LUNAR COMM.RELAY UNIT	E1002.1		1	ZONE F1	54.4	6.9	.0	108.0
ANTENNA,HIGH GAIN(CABLE+MAST)	E1002.4		1	ZONE F4	10.3	13.9	-14.3	145.0
ANTENNA,LOW GAIN(CABLE+MAST)	E1002.5		1	ZONE E1	2.5	62.0	-8.0	139.8
PALLET,LRV AFT CHASSIS	D3067.		1	WITHIN ZONE A1 (2)	29.1	120.0	-.7	116.6
WISE DEVICE,DRILL STRING	D3072.		1	WITHIN ZONE A12 (1)	.3	119.0	19.5	128.0
HOLDER,LRV MAP	R1002.		1	WITHIN ZONE D1 (2)	.5	62.0	13.5	126.0
LUNAR SURFACE MAPS,LM	A0114.13		1	WITHIN ZONE D1 (2)	.5	62.0	13.5	126.0
CHECKLIST,EVA CUFF	B1040.		1	CREW STATION - LEFT	.3	84.9	-14.5	124.5
CHECKLIST,EVA CUFF	B1040.		1	CREW STATION - RIGHT	.3	84.9	14.5	124.5
CHRONOGRAPH	A0202.		1	CREW STATION - LEFT	.1	84.9	-14.5	124.5
CHRONOGRAPH	A0202.		1	CREW STATION - RIGHT	.1	84.9	14.5	124.5
SUBSYSTEM,FECAL CONTAINMENT	B0113.		1	CREW STATION - LEFT	.3	84.9	-14.5	124.5
SUBSYSTEM,FECAL CONTAINMENT	B0113.		1	CREW STATION - RIGHT	.3	84.9	14.5	124.5
UCTA	B0205.		1	CREW STATION - LEFT	.5	84.9	-14.5	124.5
UCTA	B0205.		1	CREW STATION - RIGHT	.5	84.9	14.5	124.5
ASSY,BIOBELT	B0207.		1	CREW STATION - LEFT	.2	84.9	-14.5	124.5
ASSY,BIOBELT	B0207.		1	CREW STATION - RIGHT	.2	84.9	14.5	124.5
ITLSA - CDR	B0211.		1	CREW STATION - LEFT	46.9	84.9	-14.5	124.5
ITLSA - LMP	B0211.		1	CREW STATION - RIGHT	46.9	84.9	14.5	124.5
HELMET ASSY,PRESSURE	B0214.		1	CREW STATION - LEFT	2.6	84.9	-14.5	124.5
HELMET ASSY,PRESSURE	B0214.		1	CREW STATION - RIGHT	2.6	84.9	14.5	124.5
HARNESS,ELEC.SUIT	B0215.		1	CREW STATION - LEFT	.5	84.9	-14.5	124.5
HARNESS,ELEC.SUIT	B0215.		1	CREW STATION - RIGHT	.5	84.9	14.5	124.5
HARNESS,BIOINSTRUMENTATION	B0216.		1	CREW STATION - LEFT	.3	84.9	-14.5	124.5
HARNESS,BIOINSTRUMENTATION	B0216.		1	CREW STATION - RIGHT	.3	84.9	14.5	124.5
CARRIER,COMMUNICATION	B0217.		1	CREW STATION - LEFT	1.6	84.9	-14.5	124.5
CARRIER,COMMUNICATION	B0217.		1	CREW STATION - RIGHT	1.6	84.9	14.5	124.5
POCKET,CHECKLIST	B0219.		1	WITHIN ZONE D1 (2)	.2	62.0	13.5	126.0
POCKET,CHECKLIST	B0219.		1	WITHIN ZONE D1 (2)	.2	62.0	13.5	126.0

3.1-16

SNA-B-D-027(III) REV 3

U
 N
 I
 T
 E
 D
 S
 T
 A
 T
 E
 S
 P
 E
 C
 I
 F
 I
 C
 A
 T
 I
 O
 N
 S

TABLE 3.1-3.1 (CONTINUED)

Amendment 110
7/19/71

LRV MASS PROPERTIES								
FIRST TRAVERSE DEPARTURE - TWO CREW								
						LRV COORDINATES		
DESCRIPTION	STOW. ITEM	REF	NO.	STOWAGE LOCATION	WEIGHT	X-C.G.	Y-C.G.	Z-C.G.
REMOTE CNTRCL UNIT, PLSS	B1001.		1	CREW STATION - LEFT	5.1	84.9	-14.5	124.5
REMOTE CNTRCL UNIT, PLSS	B1001.		1	CREW STATION - RIGHT	5.1	84.9	14.5	124.5
OXYGEN PURGE SYSTEM (OPS)	B1012.		1	CREW STATION - LEFT	35.9	84.9	-14.5	124.5
L.E.V.A.	B1014.		1	CREW STATION - LEFT	5.6	84.9	-14.5	124.5
L.E.V.A.	B1014.		1	CREW STATION - RIGHT	5.6	84.9	14.5	124.5
GLOVES, EVA	B1015.		1	CREW STATION - LEFT	2.9	84.9	-14.5	124.5
GLOVES, EVA	B1015.		1	CREW STATION - RIGHT	2.9	84.9	14.5	124.5
OVERSHOES, LUNAR	BU018.		1	CREW STATION - LEFT	4.5	84.9	-14.5	124.5
OVERSHOES, LUNAR	B1018.		1	CREW STATION - RIGHT	4.5	84.9	14.5	124.5
TETHER, WAIST EVA	B1020.6		1	CREW STATION - LEFT	.5	84.9	-14.5	124.5
TETHER, WAIST EVA	B1020.7		1	CREW STATION - RIGHT	.5	84.9	14.5	124.5
PLSS/EVCS ASSY	B1024.		1	CREW STATION - LEFT	100.9	84.9	-14.5	124.5
PLSS/EVCS ASSY	B1025.		1	CREW STATION - RIGHT	100.9	84.9	14.5	124.5
GARMENT, LIQUID COOLING	B1030.		1	CREW STATION - LEFT	4.3	84.9	-14.5	124.5
GARMENT, LIQUID COOLING	B1030.		1	CREW STATION - RIGHT	4.3	84.9	14.5	124.5
SAFETY LINE, L.S. (100FT)	B1041.		1	WITHIN ZONE A3 (5)	1.3	120.6	-20.5	117.2
BRUSH, LUNAR DUST	B1045.		1	WITHIN ZONE A1 (3)	1.4	120.7	-4.3	125.7
BAG, L.S. SAFETY LINE	B1047.		1	WITHIN ZONE A3 (5)	.1	120.6	-20.5	117.2
DEVICE, DRINKING (IN SUIT)	B1048.		1	CREW STATION - LEFT	2.8	84.9	-14.5	124.5
DEVICE, DRINKING (IN SUIT)	B1048.		1	CREW STATION - RIGHT	2.8	84.9	14.5	124.5
BUDDY SLSS ASSY	B1052.		1	ZONE C1	7.3	99.2	14.5	119.8
OXYGEN PURGE SYSTEM (OPS)	B1059.		1	CREW STATION - RIGHT	35.9	84.9	14.5	124.5
CARRIER, PLSS TOOL (CDR)	B1063.		1	CREW STATION - LEFT	1.5	84.9	-14.5	124.5
CARRIER, PLSS TOOL (LMP)	B1064.		1	CREW STATION - RIGHT	1.5	84.9	14.5	124.5
BIOINSTRUMENTATION ASSY	CO201.		1	CREW STATION - LEFT	1.1	84.9	-14.5	124.5
BIOINSTRUMENTATION ASSY	CO201.		1	CREW STATION - RIGHT	1.1	84.9	14.5	124.5
DOSIMETER, PERSONAL	DO200.		1	CREW STATION - LEFT	.4	84.9	-14.5	124.5
DOSIMETER, PERSONAL	DO200.		1	CREW STATION - RIGHT	.4	84.9	14.5	124.5
LM PILOT	N/A		1	CREW STATION - RIGHT	163.5	84.9	14.5	124.5
COMMANDER	N/A		1	CREW STATION - LEFT	183.0	84.9	-14.5	124.5

3.1-17

SNA-8-D-027(III) REV 3

U
H
M
N
O
P
Q
R
S
T
U
V
W
X
Y
Z

TABLE 3.1-3.1 (CONTINUED)

Amendment 110
7/19/71

LRV MASS PROPERTIES									
FIRST TRAVERSE DEPARTURE - TWO CREW									
LRV COORDINATES									
DESCRIPTION	STOW. ITEM	REF	NC.	STORAGE LOCATION	WEIGHT	X-C.G.	Y-C.G.	Z-C.G.	
S-059 EXTRA COLLECTION BAG 6	G4048.		1	WITHIN ZONE A13(3)	1.2	121.9	10.3	115.9	
S-059 SAMPLE COLLECTION BAG 7	G4056.B		1	WITHIN ZONE A1 (4)	1.8	121.9	-4.2	115.9	
S-C59 EXTRA COLLECTION BAG 8	G4048.		1	WITHIN ZONE A13(3)	1.2	121.9	10.3	115.9	
S-C59 SAMPLE COLLECTION BAG 4	G4056.A		1	WITHIN ZONE C1 (1)	1.8	98.0	30.6	120.0	
S-059 SAMPLE COLLECTION BAG 1	G4003.1		1	WITHIN ZONE A3 (1)	1.8	98.0	-27.5	120.0	
S-059 EXTRA COLLECTION BAG 3	G4048.		1	WITHIN ZONE A4 (1)	1.2	115.7	-6.6	117.8	
S-059 EXTRA COLLECTION BAG 2	G4048.		1	WITHIN ZONE A2 (2)	1.2	131.8	-6.0	118.2	
BAG, GNOMON STOWAGE	R1003.		1	WITHIN ZONE A3 (2)	.8	99.2	-19.5	119.8	
FIRST TRAVERSE DEPARTURE - TWO CREW					1474.00	71.88	-.34	116.89	

3.1-18

TABLE 3.1-3.1 (CONTINUED)

LRV MASS PROPERTIES								
FIRST TRAVERSE RETURN - TWO CREW								
LRV COORDINATES								
DESCRIPTION	STOW. ITEM	REF	NO.	STOWAGE LOCATION	WEIGHT	X-C.G.	Y-C.G.	Z-C.G.
LUNAR ROVER VEHICLE	K1000.		1	DEPLOY ON LUN. SURF.	463.2	53.0	- .3	103.0
S-059 S.E.S.CONTAINER	G4003.2		1	WITHIN ZONE A3 (1)	1.0	98.0	-27.5	120.0
S-059 CAPS AND DISPENSER	G4003.5		3	WITHIN ZONE A5 (1)	.2	98.0	4.5	120.0
S-059 DRILL STEMS	G4003.6		6	WITHIN ZONE A2 (2)	2.6	131.8	-6.0	118.2
S-059 DRILL STEM CAP+RETAINERS	G4003.7		2	WITHIN ZONE A2 (2)	.3	131.6	-6.0	118.2
S-059 20 BAG D.S.B.DISPENSER	G4003.3A		1	CREW STATION - LEFT	1.1	84.9	-14.5	124.5
S-059 20 BAG C.S.B.DISPENSER	G4003.3B		1	CREW STATION - RIGHT	1.1	84.9	14.5	124.5
S-059 TOOL EXTENSION	G4008.		1	NEAR RH CREW STATION	1.8	86.0	24.5	111.0
S-059 TONGS,32 INCH	G4009.A		1	WITHIN ZONE A8 (1)	1.0	126.8	-5.4	121.7
S-059 TONGS,32 INCH	G4009.B		1	WITHIN ZONE B1 (1)	1.0	86.0	-4.5	111.0
S-059 GNOMON	G4012.		1	WITHIN ZONE A3 (2)	.6	99.2	-19.5	119.8
S-059 LGE TOOL CARRIER	G4035.		1	WITHIN ZONE A2 (1)	13.8	128.2	-2.0	117.3
S-059 SCOOP,ADJ.SAMPLING	G4035.2		1	NEAR RH CREW STATION	.8	86.0	24.5	111.0
S-059 HAMMER	G4035.3		1	WITHIN ZONE A5 (1)	2.8	98.0	4.5	120.0
S-059 TOOL ASSY,DRIVE TUBE	G4035.5		1	WITHIN ZONE A5 (1)	.1	98.0	4.5	120.0
S-200 PENETROMETER,RECORDING	G4049.		1	WITHIN ZONE A8 (3)	5.8	117.2	-19.7	135.5
S-059 RAKE,LUNAR SAMPLING	G4054.		1	WITHIN ZONE A8 (4)	4.3	117.4	-10.7	130.7
MAGAZINE,16MM CAC	A0101.1		2	WITHIN ZONE B1 (2)	2.0	84.0	-19.0	103.0
MAGAZINE,ELECT.MASS.CAMERA	A0108.1		2	WITHIN ZONE B1 (3)	2.8	86.0	-19.0	103.0
CAMERA,L.S.HASSELBLAD	A1015.		2	BETWEEN CREW STATION	9.0	84.9	.0	124.5
LENS,60MM	A1016.		2	BETWEEN CREW STATION	3.4	84.9	.0	124.5
TRIGGER,L.S.HASSELBLAD	A1027.		2	BETWEEN CREW STATION	.4	84.9	.0	124.5
HANDLE,L.S.HASSELBLAD	A1027.		2	BETWEEN CREW STATION	1.0	84.9	.0	124.5
BRUSH,LENS	A1042.		2	WITHIN ZONE A3 (5)	.2	120.6	-20.5	117.2
CAMERA,POWER PACK ASSY,16MM LS	A1043.		1	ZONE D1	9.9	62.0	8.0	139.5
BRACKET,CAMERA MOUNT	B1001.1		2	BETWEEN CREW STATION	1.2	84.9	.0	124.5
STAFF,16MM CAMERA/PP	R1001.		1	WITHIN ZONE D1 (1)	1.5	62.0	8.0	130.0
70MM CAMERA w/50MM LENS,ETC.	TBD		1	BELOW LH CREW STA	10.7	85.0	-10.5	103.0
TV SYSTEM,LM CCLOR	E1001.1		1	WITHIN ZONE F1 (1)	12.9	12.5	14.3	125.0
TV CONTROL UNIT	E1001.2		1	WITHIN ZONE F1 (1)	12.5	12.5	14.3	125.0
LCRU,LUNAR COMM.RELAY UNIT	E1002.1		1	ZONE F1	54.4	6.9	.0	108.0

3.1-19

SNA-8-D-027(III) REV 3

TABLE 3.1-3.1 (CONTINUED)

LRV MASS PROPERTIES								
FIRST TRAVERSE RETURN - TWO CREW								
						LRV COORDINATES		
DESCRIPTION	STOW. ITEM	REF	NO.	STORAGE LOCATION	WEIGHT	X-C.G.	Y-C.G.	Z-C.G.
ANTENNA,HIGH GAIN(CABLE+MAST)	E1002.4		1	ZONE F4	10.3	13.9	-14.3	145.0
ANTENNA,LOW GAIN(CABLE+MAST)	E1002.5		1	ZONE E1	2.5	62.0	-8.0	139.8
PALLET,LRV AFT CHASSIS	03067.		1	WITHIN ZONE A1 (2)	29.1	120.0	-7	116.6
WISE DEVICE,DRILL STRING	03072.		1	WITHIN ZONE A12 (1)	.3	119.0	19.5	128.0
HOLDER,LRV MAP	R1002.		1	WITHIN ZONE D1 (2)	.5	62.0	13.5	126.0
LUNAR SURFACE MAPS,LM	A0114.13		1	WITHIN ZONE D1 (2)	.5	62.0	13.5	126.0
CHECKLIST,EVA CUFF	B1040.		1	CREW STATION - LEFT	.3	84.9	-14.5	124.5
CHECKLIST,EVA CUFF	B1040.		1	CREW STATION - RIGHT	.3	84.9	14.5	124.5
CHRCNOGRAPH	A0202.		1	CREW STATION - LEFT	.1	84.9	-14.5	124.5
CHRCNOGRAPH	A0202.		1	CREW STATION - RIGHT	.1	84.9	14.5	124.5
SUBSYSTEM,FECAL CONTAINMENT	B0113.		1	CREW STATION - LEFT	.3	84.9	-14.5	124.5
SUBSYSTEM,FECAL CONTAINMENT	B0113.		1	CREW STATION - RIGHT	.3	84.9	14.5	124.5
UCTA	B0205.		1	CREW STATION - LEFT	.5	84.9	-14.5	124.5
UCTA	B0205.		1	CREW STATION - RIGHT	.5	84.9	14.5	124.5
ASSY,BIOBELT	B0207.		1	CREW STATION - LEFT	.2	84.9	-14.5	124.5
ASSY,BIOBELT	B0207.		1	CREW STATION - RIGHT	.2	84.9	14.5	124.5
ITLSA - CDR	B0211.		1	CREW STATION - LEFT	46.9	84.9	-14.5	124.5
ITLSA - LMP	B0211.		1	CREW STATION - RIGHT	46.9	84.9	14.5	124.5
HELMET ASSY,PRESSURE	B0214.		1	CREW STATION - LEFT	2.6	84.9	-14.5	124.5
HELMET ASSY,PRESSURE	B0214.		1	CREW STATION - RIGHT	2.6	84.9	14.5	124.5
HARNESS,ELEC.SUIT	B0215.		1	CREW STATION - LEFT	.5	84.9	-14.5	124.5
HARNESS,ELEC.SUIT	B0215.		1	CREW STATION - RIGHT	.5	84.9	14.5	124.5
HARNESS,BIOINSTRUMENTATION	B0216.		1	CREW STATION - LEFT	.3	84.9	-14.5	124.5
HARNESS,BIOINSTRUMENTATION	B0216.		1	CREW STATION - RIGHT	.3	84.9	14.5	124.5
CARRIER,CMMUNICATION	B0217.		1	CREW STATION - LEFT	1.6	84.9	-14.5	124.5
CARRIER,CMMUNICATION	B0217.		1	CREW STATION - RIGHT	1.6	84.9	14.5	124.5
POCKET,CHECKLIST	B0219.		1	WITHIN ZONE D1 (2)	.2	62.0	13.5	126.0
POCKET,CHECKLIST	B0219.		1	WITHIN ZONE D1 (2)	.2	62.0	13.5	126.0
REMOTE CONTROL UNIT,PLSS	B1001.		1	CREW STATION - LEFT	5.1	84.9	-14.5	124.5
REMOTE CONTROL UNIT,PLSS	B1001.		1	CREW STATION - RIGHT	5.1	84.9	14.5	124.5
OXYGEN PURGE SYSTEM (OPS)	B1012.		1	CREW STATION - LEFT	35.9	84.9	-14.5	124.5

3.1-20

SNA-8-D-027(III) REV 3

U
N
I
T
E
D
S
T
A
T
E
S
O
F
A
M
E
R
I
C
A

TABLE 3.1-3.1 (CONTINUED)

LRV MASS PROPERTIES								
FIRST TRAVERSE RETURN - TWO CREW								
DESCRIPTION	STOW. ITEM	REF	NO.	STOWAGE LOCATION	WEIGHT	LRV COORDINATES		
						X-C.G.	Y-C.G.	Z-C.G.
SAMPLES IN BAG 4	N/A		1	WITHIN ZONE C1 (1)	14.5	98.0	30.6	120.0
S-059 SAMPLE COLLECTION BAG 1	G4003.1		1	WITHIN ZONE A3 (1)	1.8	98.0	-27.5	120.0
CORE STEMS+SAMPLES IN BAG 1	N/A		1	WITHIN ZONE A3 (1)	5.8	98.0	-27.5	120.0
SAMPLES IN BAG 1	N/A		1	WITHIN ZONE A3 (1)	14.9	98.0	-27.5	120.0
S-059 EXTRA COLLECTION BAG 3	G4048.		1	WITHIN ZONE A4 (1)	1.2	115.7	-6.6	117.8
S-059 EXTRA COLLECTION BAG 2	G4048.		1	WITHIN ZONE A2 (2)	1.2	131.8	-6.0	118.2
BAG,GNCMCN STOWAGE	R1003.		1	WITHIN ZONE A3 (2)	.8	99.2	-19.5	119.8
FIRST TRAVERSE RETURN - TWO CREW					1507.40	72.46	-38	116.96

3.1-22

TABLE 3.1-3.1 (CONTINUED)

LRV MASS PROPERTIES								
FIRST TRAVERSE DEPARTURE - ONE CREW								
						LRV COORDINATES		
DESCRIPTION	STOW. ITEM	REF	NG.	STORAGE LOCATION	WEIGHT	X-C.G.	Y-C.G.	Z-C.G.
LUNAR ROVER VEHICLE	K1000.		1	DEPLOY UN LUN.SURF.	463.2	53.0	-.3	103.0
S-059 S.E.S.CONTAINER	G4003.2		1	WITHIN ZONE A3 (1)	1.0	98.0	-27.5	120.0
S-059 CAPS AND DISPENSER	G4003.5		3	WITHIN ZONE A5 (1)	.2	98.0	4.5	120.0
S-059 DRILL STEMS	G4003.6		6	WITHIN ZONE A2 (2)	2.6	131.8	-6.0	118.2
S-059 DRILL STEM CAP+RETAINERS	G4003.7		2	WITHIN ZONE A2 (2)	.3	131.8	-6.0	118.2
S-059 20 BAG D.S.B.DISPENSER	G4003.3A		1	CREW STATION - LEFT	1.1	84.9	-14.5	124.5
S-059 20 BAG D.S.B.DISPENSER	G4003.3B		1	CREW STATION - RIGHT	1.1	84.9	14.5	124.5
S-059 TOOL EXTENSION	G4008.		1	WITHIN ZONE A3 (6)	1.8	126.8	-14.9	123.4
S-059 TONGS, 32 INCH	G4009.A		1	WITHIN ZONE A8 (1)	1.0	126.8	-5.4	121.7
S-059 TONGS, 32 INCH	G4009.B		1	WITHIN ZONE B1 (1)	1.0	86.0	-4.5	111.0
S-059 GNCMON	G4012.		1	WITHIN ZONE A3 (2)	.6	99.2	-19.5	119.8
S-059 LGE TOOL CARRIER	G4035.		1	WITHIN ZONE A2 (1)	13.8	128.2	-2.0	117.3
S-059 SCOOP, ADJ. SAMPLING	G4035.2		1	WITHIN ZONE A2 (1)	.8	128.2	-2.0	117.3
S-059 HAMMER	G4035.3		1	WITHIN ZONE A2 (1)	2.8	128.2	-2.0	117.3
S-059 TOOL ASSY, DRIVE TUBE	G4035.5		1	WITHIN ZONE A2 (1)	.1	128.2	-2.0	117.3
S-200 PENETROMETER, RECORDING	G4049.		1	WITHIN ZONE A8 (3)	5.8	117.2	-19.7	135.5
S-059 RAKE, LUNAR SAMPLING	G4054.		1	WITHIN ZONE A8 (4)	4.3	117.4	-10.7	130.7
MAGAZINE, 16MM CAC	A0101.1		2	WITHIN ZONE B1 (2)	2.0	84.0	-19.0	103.0
MAGAZINE, ELECT. PASS. CAMERA	A0108.1		2	WITHIN ZONE B1 (3)	2.8	86.0	-19.0	103.0
BRUSH, LENS	A1042.		2	WITHIN ZONE A3 (5)	.2	120.6	-20.5	117.2
CAMERA, POWER PACK ASSY, 16MM LS	A1043.		1	ZONE D1	9.9	62.0	8.0	139.5
STAFF, 16MM CAMERA/PP	R1001.		1	WITHIN ZONE D1 (1)	1.5	62.0	8.0	130.0
70MM CAMERA W/5COMM LENS, ETC.	TBD		1	BELOW LH CREW STA	10.7	85.0	-10.5	103.0
TV SYSTEM, LM CCLCR	E1001.1		1	WITHIN ZONE F1 (1)	12.9	12.5	14.3	125.0
TV CONTRUL UNIT	E1001.2		1	WITHIN ZONE F1 (1)	12.5	12.5	14.3	125.0
LCRU, LUNAR COMM. RELAY UNIT	E1002.1		1	ZONE F1	54.4	6.9	.0	108.0
ANTENNA, HIGH GAIN (CABLE+MAST)	E1002.4		1	ZONE F4	10.3	13.9	-14.3	145.0
ANTENNA, LOW GAIN (CABLE+MAST)	E1002.5		1	ZONE E1	2.5	62.0	-8.0	139.8
PALLET, LRV AFT CHASSIS	O3067.		1	WITHIN ZONE A1 (2)	29.1	120.0	-.7	116.6
WISE DEVICE, DRILL STRING	O3072.		1	WITHIN ZONE A12 (1)	.3	119.0	19.5	128.0
HOLDER, LRV MAP	R1002.		1	WITHIN ZONE D1 (2)	.5	62.0	13.5	126.0
LUNAR SURFACE MAPS, LM	A0114.13		1	WITHIN ZONE D1 (2)	.5	62.0	13.5	126.0

3.1-23

SNA-8-D-027(III) REV 3

U
N
I
T
E
D
S
T
A
T
E
S
A
S
T
R
O
N
A
U
T
I
C
A
S
O
N
A
S
T
R
O
N
A
U
T
I
C
A
S
O
N

TABLE 3.1-3.1 (CONTINUED)

LRV MASS PROPERTIES								
FIRST TRAVERSE DEPARTURE - ONE CREW								
DESCRIPTION	STOW. ITEM	REF	NO.	STORAGE LOCATION	WEIGHT	LRV COORDINATES		
						X-C.G.	Y-C.G.	Z-C.G.
CHECKLIST, EVA CUFF	B1040.		1	CREW STATION - LEFT	.3	84.9	-14.5	124.5
CHRENGGRAPH	A0202.		1	CREW STATION - LEFT	.1	84.9	-14.5	124.5
SUBSYSTEM, FECAL CONTAINMENT	B0113.		1	CREW STATION - LEFT	.3	84.9	-14.5	124.5
UCTA	B0205.		1	CREW STATION - LEFT	.5	84.9	-14.5	124.5
ASSY, BIOBELT	B0207.		1	CREW STATION - LEFT	.2	84.9	-14.5	124.5
ITLSA - CDR	B0211.		1	CREW STATION - LEFT	46.9	84.9	-14.5	124.5
HELMET ASSY, PRESSURE	B0214.		1	CREW STATION - LEFT	2.6	84.9	-14.5	124.5
HARNES, ELEC. SUIT	B0215.		1	CREW STATION - LEFT	.5	84.9	-14.5	124.5
HARNES, BIOINSTRUMENTATION	B0216.		1	CREW STATION - LEFT	.3	84.9	-14.5	124.5
CARRIER, COMMUNICATION	B0217.		1	CREW STATION - LEFT	1.6	84.9	-14.5	124.5
POCKET, CHECKLIST	B0219.		1	WITHIN ZONE D1 (2)	.2	62.0	13.5	126.0
REMCTE CNTRCL UNIT, PLSS	B1001.		1	CREW STATION - LEFT	5.1	84.9	-14.5	124.5
OXYGEN PURGE SYSTEM (OPS)	B1012.		1	CREW STATION - LEFT	35.9	84.9	-14.5	124.5
L.E.V.A.	B1014.		1	CREW STATION - LEFT	5.6	84.9	-14.5	124.5
GLOVES, EVA	B1015.		1	CREW STATION - LEFT	2.9	84.9	-14.5	124.5
OVERSHGES, LUNAR	BU018.		1	CREW STATION - LEFT	4.5	84.9	-14.5	124.5
TETHER, WAIST EVA	B102C.6		1	CREW STATION - LEFT	.5	84.9	-14.5	124.5
PLSS/EVCS ASSY	B1024.		1	CREW STATION - LEFT	100.9	84.9	-14.5	124.5
GARMENT, LIQUID COOLING	B1030.		1	CREW STATION - LEFT	4.3	84.9	-14.5	124.5
SAFETY LINE, L.S. (100FT)	B1041.		1	WITHIN ZONE A3 (5)	1.3	120.6	-20.5	117.2
BRUSH, LUNAR DUST	B1045.		1	WITHIN ZONE A1 (3)	1.4	120.7	-4.3	125.7
BAG, L.S. SAFETY LINE	B1047.		1	WITHIN ZONE A3 (5)	.1	120.6	-20.5	117.2
DEVICE, DRINKING (IN SUIT)	B1048.		1	CREW STATION - LEFT	2.8	84.9	-14.5	124.5
BUDDY SLSS ASSY	B1052.		1	ZONE C1	7.3	99.2	14.5	119.8
CARRIER, PLSS TCCL (CDK)	B1063.		1	CREW STATION - LEFT	1.5	84.9	-14.5	124.5
BIOINSTRUMENTATION ASSY	C0201.		1	CREW STATION - LEFT	1.1	84.9	-14.5	124.5
DOSIMETER, PERSONAL	D0200.		1	CREW STATION - LEFT	.4	84.9	-14.5	124.5
COMMANDER	N/A		1	CREW STATION - LEFT	183.0	84.9	-14.5	124.5
S-078 LASER RANGING REFLECTOR	G4034.		1	RT CREW STATION	90.2	86.0	14.5	116.0
S-037 APOLLO LUNAR DRILL ASSY	G4047.		1	UNDER RH CREW STA	26.5	82.0	14.5	104.0
UNIVERSAL HANDLING TOOL	T8D		1	WITHIN ZONE B1 (1)	.5	86.0	-4.5	111.0
S-059 EXTRA COLLECTION BAG 6	G4048.		1	WITHIN ZONE A13(3)	1.2	121.9	10.3	115.9

3.1-24

SNA-8-D-027(III) REV 3

TABLE 3.1-3.1 (CONTINUED)

LRV MASS PROPERTIES								
FIRST TRAVERSE DEPARTURE - ONE CREW								
DESCRIPTION	STOW. ITEM	REF	NO.	STOWAGE LOCATION	WEIGHT	LRV COORDINATES		
						X-C.G.	Y-C.G.	Z-C.G.
S-059 SAMPLE COLLECTION BAG 7	G4056.B		1	WITHIN ZONE A1 (4)	1.8	121.9	-4.2	115.9
S-059 EXTRA COLLECTION BAG 8	G4048.		1	WITHIN ZONE A13(3)	1.2	121.9	10.3	115.9
S-059 SAMPLE COLLECTION BAG 4	G4056.A		1	UNDER RH CREW STA	1.8	84.9	14.5	103.0
SAMPLES IN BAG 4	N/A		1	UNDER RH CREW STA	14.5	84.9	14.5	103.0
S-059 SAMPLE COLLECTION BAG 1	G4003.1		1	WITHIN ZONE A13 (2)	1.8	131.8	6.0	118.2
CORE STEMS+SAMPLES IN BAG 1	N/A		1	WITHIN ZONE A13 (2)	5.8	131.8	6.0	118.2
SAMPLES IN BAG 1	N/A		1	WITHIN ZONE A13 (2)	14.9	131.8	6.0	118.2
S-059 EXTRA COLLECTION BAG 3	G4048.		1	WITHIN ZONE A4 (1)	1.2	115.7	-6.6	117.8
S-059 EXTRA COLLECTION BAG 2	G4048.		1	WITHIN ZONE A2 (2)	1.2	131.8	-6.0	118.2
L.S.HASSELBLAD CAMERA	A1015.A		1	CREW STATION - LEFT	7.5	84.9	-14.5	124.5
L.S.HASSELBLAD CAMERA	A1015.B		1	WITHIN ZONE B1 (4)	7.5	84.9	-14.5	103.0
BAG,GNOMON STOWAGE	R1003.		1	WITHIN ZONE A3 (2)	.8	99.2	-19.5	119.8
RECONFIGURATION FOR ALSEP DEPLOY - ONE CREW					1232.10	70.29	-3.58	113.90

3.1-25

TABLE 3.1-3.1 (CONTINUED)

Amendment 110
7/19/71

LRV MASS PROPERTIES								
FIRST TRAVERSE RETURN - TWO CREW								
LRV COORDINATES								
DESCRIPTION	STOW. ITEM	REF	NO.	STOWAGE LOCATION	WEIGHT	X-C.G.	Y-C.G.	Z-C.G.
LUNAR ROVER VEHICLE	K1000.		1	DEPLOY ON LUN.SURF.	463.2	53.0	-.3	103.0
S-059 S.E.S.CONTAINER	G4003.2		1	WITHIN ZONE A3 (1)	1.0	98.0	-27.5	120.0
S-059 CAPS AND DISPENSER	G4003.5		3	WITHIN ZONE A5 (1)	.2	98.0	4.5	120.0
S-059 DRILL STEM CAP+RETAINERS	G4003.7		2	WITHIN ZONE A2 (2)	.3	131.8	-6.0	118.2
S-059 20 BAG D.S.B.DISPENSER	G4003.3A		1	CREW STATION - LEFT	1.1	84.9	-14.5	124.5
S-059 20 BAG D.S.B.DISPENSER	G4003.3B		1	CREW STATION - RIGHT	1.1	84.9	14.5	124.5
S-059 TOOL EXTENSION	G4008.		1	WITHIN ZONE A3 (6)	1.8	126.8	-14.9	123.4
S-059 TONGS, 32 INCH	G4009.A		1	WITHIN ZONE A8 (1)	1.0	126.8	-5.4	121.7
S-059 TONGS, 32 INCH	G4009.B		1	WITHIN ZONE B1 (1)	1.0	86.0	-4.5	111.0
S-059 GNCMON	G4012.		1	WITHIN ZONE A3 (2)	.6	99.2	-19.5	119.8
S-059 LGE TOOL CARRIER	G4035.		1	WITHIN ZONE A2 (1)	13.8	128.2	-2.0	117.3
S-059 SCOOP, ADJ. SAMPLING	G4035.2		1	WITHIN ZONE A2 (1)	.8	128.2	-2.0	117.3
S-059 HAMMER	G4035.3		1	WITHIN ZONE A2 (1)	2.8	128.2	-2.0	117.3
S-059 TOOL ASSY, DRIVE TUBE	G4035.5		1	WITHIN ZONE A2 (1)	.1	128.2	-2.0	117.3
S-200 PENETROMETER, RECORDING	G4049.		1	WITHIN ZONE A8 (3)	5.8	117.2	-19.7	135.5
S-059 RAKE, LUNAR SAMPLING	G4054.		1	WITHIN ZONE A8 (4)	4.3	117.4	-10.7	130.7
MAGAZINE, 16MM CAC	A0101.1		2	WITHIN ZONE B1 (2)	2.0	84.0	-19.0	103.0
MAGAZINE, ELECT. PASS. CAMERA	A0108.1		2	WITHIN ZONE B1 (3)	2.8	86.0	-19.0	103.0
BRUSH, LENS	A1042.		2	WITHIN ZONE A3 (5)	.2	120.6	-20.5	117.2
CAMERA, POWER PACK ASSY, 16MM LS	A1043.		1	ZONE D1	9.9	62.0	8.0	139.5
STAFF, 16MM CAMERA/PP	R1001.		1	WITHIN ZONE D1 (1)	1.5	62.0	8.0	130.0
70MM CAMERA W/500MM LENS, ETC.	TBD		1	BELOW LH CREW STA	10.7	85.0	-10.5	103.0
TV SYSTEM, LM CCLR	E1001.1		1	WITHIN ZONE F1 (1)	12.9	12.5	14.3	125.0
TV CONTROL UNIT	E1001.2		1	WITHIN ZONE F1 (1)	12.5	12.5	14.3	125.0
LCRU, LUNAR COMM. RELAY UNIT	E1002.1		1	ZONE F1	54.4	6.9	.0	108.0
ANTENNA, HIGH GAIN (CABLE+MAST)	E1002.4		1	ZONE F4	10.3	13.9	-14.3	145.0
ANTENNA, LOW GAIN (CABLE+MAST)	E1002.5		1	ZONE E1	2.5	62.0	-8.0	139.8
PALLET, LRV AFT CHASSIS	O3067.		1	WITHIN ZONE A1 (2)	24.1	120.0	-.7	116.6
WISE DEVICE, DRILL STRING	U3072.		1	WITHIN ZONE A12 (1)	.3	119.0	19.5	128.0
HOLDER, LRV MAP	R1002.		1	WITHIN ZONE D1 (2)	.5	62.0	13.5	126.0

3.1-26

SNA-8-D-027(III) REV 3

TABLE 3.1-3.1 (CONTINUED)

Amendment 110
7/19/71

LRV MASS PROPERTIES								
FIRST TRAVERSE RETURN - TWO CREW								
DESCRIPTION	STOW. ITEM	REF	NO.	STOWAGE LOCATION	WEIGHT	LRV COORDINATES		
						X-C.G.	Y-C.G.	Z-C.G.
LUNAR SURFACE MAPS,LM	A0114.13		1	WITHIN ZONE D1 (2)	.5	62.0	13.5	126.0
CHECKLIST,EVA CUFF	B1040.		1	CREW STATION - LEFT	.3	84.9	-14.5	124.5
CHECKLIST,EVA CUFF	B1040.		1	CREW STATION - RIGHT	.3	84.9	14.5	124.5
CHRONOGRAPH	A0202.		1	CREW STATION - LEFT	.1	84.9	-14.5	124.5
CHRONOGRAPH	A0202.		1	CREW STATION - RIGHT	.1	84.9	14.5	124.5
SUBSYSTEM,FECAL CONTAINMENT	B0113.		1	CREW STATION - LEFT	.3	84.9	-14.5	124.5
SUBSYSTEM,FECAL CONTAINMENT	B0113.		1	CREW STATION - RIGHT	.3	84.9	14.5	124.5
UCTA	B0205.		1	CREW STATION - LEFT	.5	84.9	-14.5	124.5
UCTA	B0205.		1	CREW STATION - RIGHT	.5	84.9	14.5	124.5
ASSY,810BELT	B0207.		1	CREW STATION - LEFT	.2	84.9	-14.5	124.5
ASSY,810BELT	B0207.		1	CREW STATION - RIGHT	.2	84.9	14.5	124.5
ITLSA - CDR	B0211.		1	CREW STATION - LEFT	46.9	84.9	-14.5	124.5
ITLSA - LMP	B0211.		1	CREW STATION - RIGHT	46.9	84.9	14.5	124.5
HELMET ASSY,PRESSURE	B0214.		1	CREW STATION - LEFT	2.6	84.9	-14.5	124.5
HELMET ASSY,PRESSURE	B0214.		1	CREW STATION - RIGHT	2.6	84.9	14.5	124.5
HARNESS,ELEC.SLIT	B0215.		1	CREW STATION - LEFT	.5	84.9	-14.5	124.5
HARNESS,ELEC.SUIT	B0215.		1	CREW STATION - RIGHT	.5	84.9	14.5	124.5
HARNESS,810INSTRUMENTATION	B0216.		1	CREW STATION - LEFT	.3	84.9	-14.5	124.5
HARNESS,810INSTRUMENTATION	B0216.		1	CREW STATION - RIGHT	.3	84.9	14.5	124.5
CARRIER,COMMUNICATION	B0217.		1	CREW STATION - LEFT	1.6	84.9	-14.5	124.5
CARRIER,COMMUNICATION	B0217.		1	CREW STATION - RIGHT	1.6	84.9	14.5	124.5
POCKET,CHECKLIST	B0219.		1	WITHIN ZONE D1 (2)	.2	62.0	13.5	126.0
POCKET,CHECKLIST	B0219.		1	WITHIN ZONE D1 (2)	.2	62.0	13.5	126.0
REMOTE CONTROL UNIT,PLSS	B1001.		1	CREW STATION - LEFT	5.1	84.9	-14.5	124.5
REMOTE CONTROL UNIT,PLSS	B1001.		1	CREW STATION - RIGHT	5.1	84.9	14.5	124.5
OXYGEN PURGE SYSTEM (OPS)	B1012.		1	CREW STATION - LEFT	35.9	84.9	-14.5	124.5
L.E.V.A.	B1014.		1	CREW STATION - LEFT	5.6	84.9	-14.5	124.5
L.E.V.A.	B1014.		1	CREW STATION - RIGHT	5.6	84.9	14.5	124.5
GLOVES,EVA	B1015.		1	CREW STATION - LEFT	2.9	84.9	-14.5	124.5
GLOVES,EVA	B1015.		1	CREW STATION - RIGHT	2.9	84.9	14.5	124.5

3.1-27

SNA-B-D-027(III) REV 3

TABLE 3.1-3.1 (CONTINUED)

Amendment 110
7/19/71

LRV MASS PROPERTIES								
FIRST TRAVERSE RETURN - TWO CREW								
LRV COORDINATES								
DESCRIPTION	STCW. ITEM	REF	NO.	STOWAGE LOCATION	WEIGHT	X-C.G.	Y-C.G.	Z-C.G.
OVERSHCES,LUNAR	8U018.		1	CREW STATION - LEFT	4.5	84.9	-14.5	124.5
OVERSHCES,LUNAR	81018.		1	CREW STATION - RIGHT	4.5	84.9	14.5	124.5
TETHER,WAIST EVA	81020.6		1	CREW STATION - LEFT	.5	84.9	-14.5	124.5
TETHER,WAIST EVA	81020.7		1	CREW STATION - RIGHT	.5	84.9	14.5	124.5
PLSS/EVCS ASSY	81024.		1	CREW STATION - LEFT	100.9	84.9	-14.5	124.5
PLSS/EVCS ASSY	81025.		1	CREW STATION - RIGHT	100.9	84.9	14.5	124.5
GARMENT,LIQUID COOLING	81030.		1	CREW STATION - LEFT	4.3	84.9	-14.5	124.5
GARMENT,LIQUID COOLING	81030.		1	CREW STATION - RIGHT	4.3	84.9	14.5	124.5
SAFETY LINE,L.S.(100FT)	81041.		1	WITHIN ZONE A3 (5)	1.3	120.6	-20.5	117.2
BRUSH,LUNAR DUST	81045.		1	WITHIN ZONE A1 (3)	1.4	120.7	-4.3	125.7
BAG,L.S.SAFETY LINE	81047.		1	WITHIN ZONE A3 (5)	.1	120.6	-20.5	117.2
DEVICE,DRINKING(IN SUIT)	81048.		1	CREW STATION - LEFT	2.8	84.9	-14.5	124.5
DEVICE,DRINKING(IN SUIT)	81048.		1	CREW STATION - RIGHT	2.8	84.9	14.5	124.5
BUDDY SLSS ASSY	81052.		1	ZONE C1	7.3	99.2	14.5	119.8
OXYGEN PURGE SYSTEM (OPS)	81059.		1	CREW STATION - RIGHT	35.9	84.9	14.5	124.5
CARRIER,PLSS TCOL (CDR)	81063.		1	CREW STATION - LEFT	1.5	84.9	-14.5	124.5
CARRIER,PLSS TCOL (LMP)	81064.		1	CREW STATION - RIGHT	1.5	84.9	14.5	124.5
BIOINSTRUMENTATION ASSY	C0201.		1	CREW STATION - LEFT	1.1	84.9	-14.5	124.5
BIOINSTRUMENTATION ASSY	C0201.		1	CREW STATION - RIGHT	1.1	84.9	14.5	124.5
DOSIMETER,PERSONAL	D0200.		1	CREW STATION - LEFT	.4	84.9	-14.5	124.5
DOSIMETER,PERSONAL	D0200.		1	CREW STATION - RIGHT	.4	84.9	14.5	124.5
LH PILOT	N/A		1	CREW STATION - RIGHT	163.5	84.9	14.5	124.5
CUMMANDER	N/A		1	CREW STATION - LEFT	183.0	84.9	-14.5	124.5
S-C59 EXTRA COLLECTION BAG 6	G4048.		1	WITHIN ZONE A13(3)	1.2	121.9	10.3	115.9
S-059 SAMPLE COLLECTION BAG 7	G4056.B		1	WITHIN ZONE A1 (4)	1.8	121.9	-4.2	115.9
S-059 EXTRA COLLECTION BAG 8	G4048.		1	WITHIN ZONE A13(3)	1.2	121.9	10.3	115.9
S-059 SAMPLE COLLECTION BAG 4	G4056.A		1	WITHIN ZONE A2 (2)	1.8	131.8	-6.0	118.2
SAMPLES IN BAG 4	N/A		1	WITHIN ZONE A2 (2)	14.5	131.8	-6.0	118.2
S-C59 SAMPLE COLLECTION BAG 1	G4003.1		1	WITHIN ZONE A13 (2)	1.8	131.8	6.0	118.2
CORE STEMS+SAMPLES IN BAG 1	N/A		1	WITHIN ZONE A13 (2)	5.8	131.8	6.0	118.2

3.1-28

SNA-8-D-027(III) REV 3

TABLE 3.1-3.1 (CONTINUED)

LRV MASS PROPERTIES								
FIRST TRAVERSE RETURN - TWO CREW								
DESCRIPTION	STOW. ITEM	REF	NO.	STORAGE LOCATION	WEIGHT	LRV COORDINATES		
						X-C.G.	Y-C.G.	Z-C.G.
SAMPLES IN BAG 1	N/A		1	WITHIN ZONE A13 (2)	14.9	131.8	6.0	118.2
S-059 EXTRA COLLECTION BAG 3	G4048.		1	WITHIN ZONE A4 (1)	1.2	115.7	-6.6	117.8
CORE TUBE+SAMPLES IN BAG 3	N/A		1	WITHIN ZONE A4 (1)	5.8	115.7	-6.6	117.8
SAMPLES IN BAG 3	N/A		1	WITHIN ZONE A4 (1)	8.5	115.7	-6.6	117.8
S-059 EXTRA COLLECTION BAG 2	G4048.		1	WITHIN ZONE A2 (2)	1.2	131.8	-6.0	118.2
L.S.HASSELBLAD CAMERA	A1015.A		1	CREW STATION - LEFT	7.5	84.9	-14.5	124.5
L.S.HASSELBLAD CAMERA	A1015.B		1	CREW STATION - RIGHT	7.5	84.9	14.5	124.5
BAG,GNOMCN STOWAGE	R1003.		1	WITHIN ZONE A3 (2)	.8	99.2	-19.5	119.8
RETURN FROM ALSEP SITE - TWO CREW					1519.10	73.75	-4.40	116.93

3.1-29

TABLE 3.1-3.1 (CONTINUED)

LRV MASS PROPERTIES								
SECOND TRAVERSE DEPARTURE - TWO CREW								
						LRV COORDINATES		
DESCRIPTION	STOW. ITEM	REF	NO.	STOWAGE LOCATION	WEIGHT	X-C.G.	Y-C.G.	Z-C.G.
LUNAR ROVER VEHICLE	K1000.		1	DEPLOY ON LUN. SURF.	463.2	53.0	-3	103.0
S-059 20 BAG C.S.B. DISPENSER	G4003.3A		1	CREW STATION - LEFT	1.1	84.9	-14.5	124.5
S-059 TOOL EXTENSION	G4008.		1	NEAR RH CREW STATION	1.8	86.0	24.5	111.0
S-059 TONGS, 32 INCH	G4009.A		1	WITHIN ZONE A8 (1)	1.0	126.8	-5.4	121.7
S-059 TONGS, 32 INCH	G4009.B		1	WITHIN ZONE B1 (1)	1.0	86.0	-4.5	111.0
S-059 GNGMON	G4012.		1	WITHIN ZONE A3 (2)	.6	99.2	-19.5	119.8
S-059 LGE TOOL CARRIER	G4035.		1	WITHIN ZONE A2 (1)	13.8	128.2	-2.0	117.3
S-059 SCOOP, ADJ. SAMPLING	G4035.2		1	NEAR RH CREW STATION	.8	86.0	24.5	111.0
S-059 HAMMER	G4035.3		1	WITHIN ZONE A5 (1)	2.8	98.0	4.5	120.0
S-059 TOOL ASSY, DRIVE TUBE	G4035.5		1	WITHIN ZONE A5 (1)	.1	98.0	4.5	120.0
S-200 PENETROMETER, RECORDING	G4049.		1	WITHIN ZONE A8 (3)	5.8	117.2	-19.7	135.5
S-059 RAKE, LUNAR SAMPLING	G4054.		1	WITHIN ZONE A8 (4)	4.3	117.4	-10.7	130.7
MAGAZINE, 16MM CAC	A0101.1		2	WITHIN ZONE B1 (2)	2.0	84.0	-19.0	103.0
MAGAZINE, ELECT. HASS. CAMERA	A0108.1		2	WITHIN ZONE B1 (3)	2.8	86.0	-19.0	103.0
BRUSH, LENS	A1042.		2	WITHIN ZONE A3 (5)	.2	120.6	-20.5	117.2
CAMERA, POWER PACK ASSY, 16MM LS	A1043.		1	ZONE D1	9.9	62.0	8.0	139.5
STAFF, 16MM CAMERA/PP	R1001.		1	WITHIN ZONE D1 (1)	1.5	62.0	8.0	130.0
70MM CAMERA W/500MM LENS, ETC.	TBU		1	BELOW LH CREW STA	10.7	85.0	-10.5	103.0
TV SYSTEM, LM CCLOR	E1001.1		1	WITHIN ZONE F1 (1)	12.9	12.5	14.3	125.0
TV CONTROL UNIT	E1001.2		1	WITHIN ZONE F1 (1)	12.5	12.5	14.3	125.0
LCRU, LUNAR COMM. RELAY UNIT	E1002.1		1	ZONE F1	54.4	6.9	.0	108.0
ANTENNA, HIGH GAIN (CABLE+MAST)	E1002.4		1	ZONE F4	10.3	13.9	-14.3	145.0
ANTENNA, LOW GAIN (CABLE+MAST)	E1002.5		1	ZONE E1	2.5	62.0	-8.0	139.8
BATTERY, LCRU (USED)	E1002.3		1	WITHIN ZONE B1 (4)	8.9	84.9	-14.5	103.0
PALLET, LRV AFT CHASSIS	03067.		1	WITHIN ZONE A1 (2)	29.1	120.0	-.7	116.6
WISE DEVICE, DRILL STRING	03072.		1	WITHIN ZONE A12 (1)	.3	119.0	19.5	128.0
HOLDER, LRV MAP	R1002.		1	WITHIN ZONE D1 (2)	.5	62.0	13.5	126.0
LUNAR SURFACE MAPS, LM	A0114.13		1	WITHIN ZONE D1 (2)	.5	62.0	13.5	126.0
CHECKLIST, EVA CUFF	B1040.		1	CREW STATION - LEFT	.3	84.9	-14.5	124.5
CHECKLIST, EVA CUFF	B1040.		1	CREW STATION - RIGHT	.3	84.9	14.5	124.5

3.1-30

SNA-8-D-027(III) REV 3

TABLE 3.1-3.1 (CONTINUED)

LRV MASS PROPERTIES								
SECOND TRAVERSE DEPARTURE - TWO CREW								
DESCRIPTION	STOW. ITEM	REF	NO.	STOWAGE LOCATION	WEIGHT	LRV COORDINATES		
						X-C.G.	Y-C.G.	Z-C.G.
CHRCNOGRAPH	A0202.		1	CREW STATION - LEFT	.1	84.9	-14.5	124.5
CHRCNOGRAPH	A0202.		1	CREW STATION - RIGHT	.1	84.9	14.5	124.5
SUBSYSTEM,FECAL CCNTAINMENT	80113.		1	CREW STATION - LEFT	.3	84.9	-14.5	124.5
SUBSYSTEM,FECAL CCNTAINMENT	80113.		1	CREW STATION - RIGHT	.3	84.9	14.5	124.5
UCTA	80205.		1	CREW STATION - LEFT	.5	84.9	-14.5	124.5
UCTA	80205.		1	CREW STATION - RIGHT	.5	84.9	14.5	124.5
ASSY,BIOBELT	80207.		1	CREW STATION - LEFT	.2	84.9	-14.5	124.5
ASSY,BIOBELT	80207.		1	CREW STATION - RIGHT	.2	84.9	14.5	124.5
ITLSA - CDR	80211.		1	CREW STATION - LEFT	46.9	84.9	-14.5	124.5
ITLSA - LMP	80211.		1	CREW STATION - RIGHT	46.9	84.9	14.5	124.5
HELMET ASSY,PRESSURE	80214.		1	CREW STATION - LEFT	2.6	84.9	-14.5	124.5
HELMET ASSY,PRESSURE	80214.		1	CREW STATION - RIGHT	2.6	84.9	14.5	124.5
HARNES,ELEC.SUIT	80215.		1	CREW STATION - LEFT	.5	84.9	-14.5	124.5
HARNES,ELEC.SUIT	80215.		1	CREW STATION - RIGHT	.5	84.9	14.5	124.5
HARNES,BIOINSTRUMENTATION	80216.		1	CREW STATION - LEFT	.3	84.9	-14.5	124.5
HARNES,BIOINSTRUMENTATION	80216.		1	CREW STATION - RIGHT	.3	84.9	14.5	124.5
CARRIER,COMMUNICATION	80217.		1	CREW STATION - LEFT	1.6	84.9	-14.5	124.5
CARRIER,COMMUNICATION	80217.		1	CREW STATION - RIGHT	1.6	84.9	14.5	124.5
POCKET,CHECKLIST	80219.		1	WITHIN ZONE D1 (2)	.2	62.0	13.5	126.0
POCKET,CHECKLIST	80219.		1	WITHIN ZONE D1 (2)	.2	62.0	13.5	126.0
REMOTE CONTROL UNIT,PLSS	81001.		1	CREW STATION - LEFT	5.1	84.9	-14.5	124.5
REMOTE CONTROL UNIT,PLSS	81001.		1	CREW STATION - RIGHT	5.1	84.9	14.5	124.5
OXYGEN PURGE SYSTEM (OPS)	81012.		1	CREW STATION - LEFT	35.9	84.9	-14.5	124.5
L.E.V.A.	81014.		1	CREW STATION - LEFT	5.6	84.9	-14.5	124.5
L.E.V.A.	81014.		1	CREW STATION - RIGHT	5.6	84.9	14.5	124.5
GLOVES,EVA	81015.		1	CREW STATION - LEFT	2.9	84.9	-14.5	124.5
GLOVES,EVA	81015.		1	CREW STATION - RIGHT	2.9	84.9	14.5	124.5
OVERSHOES,LUNAR	81018.		1	CREW STATION - LEFT	4.5	84.9	-14.5	124.5
OVERSHOES,LUNAR	81018.		1	CREW STATION - RIGHT	4.5	84.9	14.5	124.5
TETHER,WAIST EVA	81020.6		1	CREW STATIGN - LEFT	.5	84.9	-14.5	124.5

3.1-31

SMA-8-D-027(III) REV 3

TABLE 3.1-3.1 (CONTINUED)

Amendment 110
7/19/71

LRV MASS PROPERTIES								
SECOND TRAVERSE DEPARTURE - TWO CREW								
						LRV COORDINATES		
DESCRIPTION	STOW. ITEM	REF	NO.	STOWAGE LOCATION	WEIGHT	X-C.G.	Y-C.G.	Z-C.G.
TETHER,WAIST EVA	B1020.7		1	CREW STATION - RIGHT	.5	84.9	14.5	124.5
PLSS/EVCS ASSY	B1024.		1	CREW STATION - LEFT	100.9	84.9	-14.5	124.5
PLSS/EVCS ASSY	B1025.		1	CREW STATION - RIGHT	100.9	84.9	14.5	124.5
GARMENT,LIQUIC COOLING	B1030.		1	CREW STATION - LEFT	4.3	84.9	-14.5	124.5
GARMENT,LIQUID COOLING	B1030.		1	CREW STATION - RIGHT	4.3	84.9	14.5	124.5
SAFETY LINE,L.S.(100FT)	B1041.		1	WITHIN ZONE A3 (5)	1.3	120.6	-20.5	117.2
BRUSH,LUNAR DUST	B1045.		1	WITHIN ZONE A1 (3)	1.4	120.7	-4.3	125.7
BAG,L.S.SAFETY LINE	B1047.		1	WITHIN ZONE A3 (5)	.1	120.6	-20.5	117.2
DEVICE,DRINKING(IN SUIT)	B1048.		1	CREW STATION - LEFT	2.8	84.9	-14.5	124.5
DEVICE,DRINKING(IN SUIT)	B1048.		1	CREW STATION - RIGHT	2.8	84.9	14.5	124.5
BUDDY SLSS ASSY	B1052.		1	ZONE C1	7.3	99.2	14.5	119.8
OXYGEN PURGE SYSTEM (OPS)	B1059.		1	CREW STATION - RIGHT	35.9	84.9	14.5	124.5
CARRIER,PLSS TCOL (CDR)	B1063.		1	CREW STATION - LEFT	1.5	84.9	-14.5	124.5
CARRIER,PLSS TCOL (LMP)	B1064.		1	CREW STATION - RIGHT	1.5	84.9	14.5	124.5
BIOINSTRUMENTATION ASSY	C0201.		1	CREW STATION - LEFT	1.1	84.9	-14.5	124.5
BIOINSTRUMENTATION ASSY	C0201.		1	CREW STATION - RIGHT	1.1	84.9	14.5	124.5
DOSIMETER,PERSONAL	D0200.		1	CREW STATION - LEFT	.4	84.9	-14.5	124.5
DOSIMETER,PERSONAL	D0200.		1	CREW STATION - RIGHT	.4	84.9	14.5	124.5
LM PILOT	N/A		1	CREW STATION - RIGHT	163.5	84.9	14.5	124.5
COMMANDER	N/A		1	CREW STATION - LEFT	183.0	84.9	-14.5	124.5
S.E.S. CONTAINER	G4004.2		1	WITHIN ZONE A3 (1)	1.0	98.0	-27.5	120.0
S.E.S. CONTAINER	G4004.2		1	WITHIN ZONE A3 (1)	1.0	98.0	-27.5	120.0
S.E.S. CONTAINER	G4004.2		1	UNDER RH CREW STA	1.0	84.9	14.5	103.0
20 BAG D.S.B.DISPENSER	G4004.3		1	CREW STATION - LEFT	1.1	84.9	-14.5	124.5
20 BAG D.S.B.DISPENSER	G4004.3		1	CREW STATION - RIGHT	1.1	84.9	14.5	124.5
20 BAG D.S.B.DISPENSER	G4004.3		2	UNDER RH CREW STA	2.2	84.9	14.5	103.0
CORE TUBES	G4004.4		3	WITHIN ZONE A3 (1)	1.8	98.0	-27.5	120.0
CORE TUBES	G4004.4		3	UNDER RH CREW STA	1.8	84.9	14.5	103.0
CAP DISPENSER	G4004.5		1	UNDER RH CREW STA	.2	84.9	14.5	103.0
S-059 EXTRA COLLECTION BAG 6	G4048.		1	WITHIN ZONE A4 (1)	1.2	115.7	-6.6	117.8

3.1-32

SNA-8-D-027(III) REV 3

U
N
I
T
E
D
S
T
A
T
E
S
O
F
A
S
T
A
S
I
A
P
A
C
I
F
I
C
O
C
E
A
N
A
R
E
A
A
D
M
I
N
I
S
T
R
A
T
I
O
N

Amendment 110
7/19/71

TABLE 3.1-3.1 (CONTINUED)

LRV MASS PROPERTIES								
SECOND TRAVERSE DEPARTURE - TWO CREW								
						LRV COORDINATES		
DESCRIPTION	STOW. ITEM	REF	NO.	STOWAGE LOCATION	WEIGHT	X-C.G.	Y-C.G.	Z-C.G.
BAG, SAMPLE COLLECTION - BAG 5	G4004.1		1	WITHIN ZONE A3 (1)	1.8	98.0	-27.5	120.0
S-059 SAMPLE COLLECTION BAG 7	G4056.B		1	WITHIN ZONE A1 (4)	1.8	121.9	-4.2	115.9
S-059 EXTRA COLLECTION BAG 8	G4048.		1	WITHIN ZONE A13(3)	1.2	121.9	10.3	115.9
S-059 EXTRA COLLECTION BAG 2	G4048.		1	WITHIN ZONE C1(1)	1.2	98.0	30.6	120.0
L.S.HASSELBLAD CAMERA	A1015.A		1	CREW STATION - LEFT	7.5	84.9	-14.5	124.5
L.S.HASSELBLAD CAMERA	A1015.B		1	CREW STATION - RIGHT	7.5	84.9	14.5	124.5
MAGAZINE, LUNAR SURFACE HASSEL.	A0108.1		1	WITHIN ZONE B1 (3)	1.4	86.0	-19.0	103.0
BAG, GACMON STOWAGE	R1003.		1	WITHIN ZONE A3 (2)	.8	99.2	-19.5	119.8
SECOND TRAVERSE DEPARTURE - TWO CREW					1485.50	71.82	-.43	116.75

3.1-33

TABLE 3.1-3.1 (CONTINUED)

LRV MASS PROPERTIES									
SECOND TRAVERSE RETURN - TWO CREW									
							LRV COORDINATES		
DESCRIPTION	STOW. ITEM	REF	NO.	STORAGE LOCATION	WEIGHT	X-C.G.	Y-C.G.	Z-C.G.	
LUNAR ROVER VEHICLE	K1000.		1	DEPLOY ON LUN.SURF.	463.2	53.0	-.3	103.0	
S-059 20 BAG D.S.B.DISPENSER	G4003.3A		1	CREW STATION - LEFT	1.1	84.9	-14.5	124.5	
S-059 TOOL EXTENSION	G4008.		1	NEAR RH CREW STATION	1.8	86.0	24.5	111.0	
S-059 TONGS, 32 INCH	G4009.A		1	WITHIN ZONE A8 (1)	1.0	126.8	-5.4	121.7	
S-059 TONGS, 32 INCH	G4009.B		1	WITHIN ZONE B1 (1)	1.0	86.0	-4.5	111.0	
S-059 GNCMON	G4012.		1	WITHIN ZONE A3 (2)	.6	99.2	-19.5	119.8	
S-059 LGE TOOL CARRIER	G4035.		1	WITHIN ZONE A2 (1)	13.8	128.2	-2.0	117.3	
S-059 SCOOP, ADJ. SAMPLING	G4035.2		1	NEAR RH CREW STATION	.8	86.0	24.5	111.0	
S-059 HAMMER	G4035.3		1	WITHIN ZONE A5 (1)	2.8	98.0	4.5	120.0	
S-059 TOOL ASSY, CRIVE TUBE	G4035.5		1	WITHIN ZONE A5 (1)	.1	98.0	4.5	120.0	
S-200 PENETROMETER, RECORDING	G4049.		1	WITHIN ZONE A8 (3)	5.8	117.2	-19.7	135.5	
S-059 RAKE, LUNAR SAMPLING	G4054.		1	WITHIN ZONE A8 (4)	4.3	117.4	-10.7	130.7	
MAGAZINE, 16MM CAC	A0101.1		2	WITHIN ZONE B1 (2)	2.0	84.0	-19.0	103.0	
MAGAZINE, ELECT. HASS. CAMERA	A0108.1		2	WITHIN ZONE B1 (3)	2.8	86.0	-19.0	103.0	
BRUSH, LENS	A1042.		2	WITHIN ZONE A3 (5)	.2	120.6	-20.5	117.2	
CAMERA, POWER PACK ASSY, 16MM LS	A1043.		1	ZONE D1	9.9	62.0	8.0	139.5	
STAFF, 16MM CAMERA/PP	R1001.		1	WITHIN ZONE D1 (1)	1.5	62.0	8.0	130.0	
70MM CAMERA W/5COMM LENS, ETC.	TBD		1	BELOW LH CREW STA	10.7	85.0	-10.5	103.0	
TV SYSTEM, LM CCLR	E1001.1		1	WITHIN ZONE F1 (1)	12.9	12.5	14.3	125.0	
TV CONTRL UNIT	E1001.2		1	WITHIN ZONE F1 (1)	12.5	12.5	14.3	125.0	
LCRU, LUNAR COMM. RELAY UNIT	E1002.1		1	ZONE F1	54.4	6.9	.0	108.0	
ANTENNA, HIGH GAIN(CABLE+MAST)	E1002.4		1	ZONE F4	10.3	13.9	-14.3	145.0	
ANTENNA, LOW GAIN(CABLE+MAST)	E1002.5		1	ZONE E1	2.5	62.0	-8.0	139.8	
BATTERY, LCRU (LSED)	E1002.3		1	WITHIN ZONE B1 (4)	8.9	84.9	-14.5	103.0	
PALLET, LRV AFT CHASSIS	O3067.		1	WITHIN ZONE A1 (2)	29.1	120.0	-.7	116.6	
WISE DEVICE, DRILL STRING	O3072.		1	WITHIN ZONE A12 (1)	.3	119.0	19.5	128.0	
HOLDER, LRV MAP	R1002.		1	WITHIN ZONE D1 (2)	.5	62.0	13.5	126.0	
LUNAR SURFACE MAPS, LM	A0114.13		1	WITHIN ZONE D1 (2)	.5	62.0	13.5	126.0	
CHECKLIST, EVA CUFF	B1040.		1	CREW STATION - LEFT	.3	84.9	-14.5	124.5	
CHECKLIST, EVA CUFF	B1040.		1	CREW STATION - RIGHT	.3	84.9	14.5	124.5	
CHRONOGRAPH	A0202.		1	CREW STATION - LEFT	.1	84.9	-14.5	124.5	

3.1-34

SNA-8-D-027(III) REV 3

TABLE 3.1-3.1 (CONTINUED)

LRV MASS PROPERTIES								
SECOND TRAVERSE RETURN - TWO CREW								
						LRV COORDINATES		
DESCRIPTION	STOW. ITEM	REF	NO.	STOWAGE LOCATION	WEIGHT	X-C.G.	Y-C.G.	Z-C.G.
PLSS/EVCS ASSY	B1025.		1	CREW STATION - RIGHT	100.9	84.9	14.5	124.5
GARMENT, LIQUID COOLING	B1030.		1	CREW STATION - LEFT	4.3	84.9	-14.5	124.5
GARMENT, LIQUID COOLING	B1030.		1	CREW STATION - RIGHT	4.3	84.9	14.5	124.5
SAFETY LINE, L.S. (100FT)	B1041.		1	WITHIN ZONE A3 (5)	1.3	120.6	-20.5	117.2
BRUSH, LUNAR DUST	B1045.		1	WITHIN ZONE A1 (3)	1.4	120.7	-4.3	125.7
BAG, L.S. SAFETY LINE	B1047.		1	WITHIN ZONE A3 (5)	.1	120.6	-20.5	117.2
DEVICE, DRINKING (IN SUIT)	B1048.		1	CREW STATION - LEFT	2.8	84.9	-14.5	124.5
DEVICE, DRINKING (IN SUIT)	B1048.		1	CREW STATION - RIGHT	2.8	84.9	14.5	124.5
BUDDY SLSS ASSY	B1052.		1	ZONE C1	7.3	99.2	14.5	119.8
OXYGEN PURGE SYSTEM (OPS)	B1059.		1	CREW STATION - RIGHT	35.9	84.9	14.5	124.5
CARRIER, PLSS TOOL (GDR)	B1063.		1	CREW STATION - LEFT	1.5	84.9	-14.5	124.5
CARRIER, PLSS TOOL (LMP)	B1064.		1	CREW STATION - RIGHT	1.5	84.9	14.5	124.5
BIOINSTRUMENTATION ASSY	CO201.		1	CREW STATION - LEFT	1.1	84.9	-14.5	124.5
BIOINSTRUMENTATION ASSY	CO201.		1	CREW STATION - RIGHT	1.1	84.9	14.5	124.5
DOSIMETER, PERSONAL	DO200.		1	CREW STATION - LEFT	.4	84.9	-14.5	124.5
DOSIMETER, PERSONAL	DO200.		1	CREW STATION - RIGHT	.4	84.9	14.5	124.5
LM PILOT	N/A		1	CREW STATION - RIGHT	163.5	84.9	14.5	124.5
COMMANDER	N/A		1	CREW STATION - LEFT	183.0	84.9	-14.5	124.5
S.E.S. CONTAINER	G4004.2		1	WITHIN ZONE A3 (1)	1.0	98.0	-27.5	120.0
S.E.S. CONTAINER	G4004.2		1	WITHIN ZONE A3 (1)	1.0	98.0	-27.5	120.0
S.E.S. CONTAINER	G4004.2		1	UNDER RH CREW STA	1.0	84.9	14.5	103.0
20 BAG D.S.B. DISPENSER	G4004.3		1	CREW STATION - LEFT	1.1	84.9	-14.5	124.5
20 BAG D.S.B. DISPENSER	G4004.3		1	CREW STATION - RIGHT	1.1	84.9	14.5	124.5
20 BAG D.S.B. DISPENSER	G4004.3		2	UNDER RH CREW STA	2.2	84.9	14.5	103.0
CORE TUBES	G4004.4		3	UNDER RH CREW STA	1.8	84.9	14.5	103.0
CAP DISPENSER	G4004.5		1	UNDER RH CREW STA	.2	84.9	14.5	103.0
S-059 EXTRA COLLECTION BAG 6	G4048.		1	WITHIN ZONE A4 (1)	1.2	115.7	-6.6	117.8
SAMPLES IN BAG 6	N/A		1	WITHIN ZONE A4 (1)	8.7	115.7	-6.6	117.8
BAG, SAMPLE COLLECTION - BAG 5	G4004.1		1	WITHIN ZONE A3 (1)	1.8	98.0	-27.5	120.0
CORE TUBE+SAMPLES IN BAG 5	N/A		1	WITHIN ZONE A3 (1)	5.6	98.0	-27.5	120.0
SAMPLES IN BAG 5	N/A		1	WITHIN ZONE A3 (1)	11.9	98.0	-27.5	120.0

3.1-36

SNA-8-D-027(III) REV 3

U
N
I
T
E
D
S
T
A
T
E
S
O
F
A
M
E
R
I
C
A

Amendment 110
7/19/71

TABLE 3.1-3.1 (CONTINUED)

LRV MASS PROPERTIES								
SECOND TRAVERSE RETURN - TWO CREW								
						LRV COORDINATES		
DESCRIPTION	STOW. ITEM	REF	NO.	STOWAGE LOCATION	WEIGHT	X-C.G.	Y-C.G.	Z-C.G.
S-059 SAMPLE COLLECTION BAG 7	G4056.B		1	WITHIN ZONE A1 (4)	1.8	121.9	-4.2	115.9
S-059 EXTRA COLLECTION BAG 8	G4048.		1	WITHIN ZONE A13(3)	1.2	121.9	10.3	115.9
S-059 EXTRA COLLECTION BAG 2	G4048.		1	WITHIN ZONE C1 (1)	1.2	98.0	30.6	120.0
SAMPLES IN BAG 2	N/A		1	WITHIN ZONE C1 (1)	8.5	98.0	30.6	120.0
L.S.HASSELBLAD CAMERA	A1015.A		1	CREW STATION - LEFT	7.5	84.9	-14.5	124.5
L.S.HASSELBLAD CAMERA	A1015.B		1	CREW STATION - RIGHT	7.5	84.9	14.5	124.5
MAGAZINE, LUNAR SURFACE HASSEL.	A0108.1		1	WITHIN ZONE B1 (3)	1.4	86.0	-19.C	103.0
BAG, GNOMON STCWAGE	R1003.		1	WITHIN ZONE A3 (2)	.8	99.2	-19.5	119.8
SECOND TRAVERSE RETURN - TWO CREW					1518.40	72.49	-.57	116.80

3.1-37

SNA-8-D-027(III) REV 3

TABLE 3.1-3.1 (CONTINUED)

LRV MASS PROPERTIES								
THIRD TRAVERSE DEPARTURE - TWO CREW								
						LRV COORDINATES		
DESCRIPTION	STOW. ITEM	REF	NO.	STOWAGE LOCATION	WEIGHT	X-C.G.	Y-C.G.	Z-C.G.
LUNAR ROVER VEHICLE	K1000.		1	DEPLOY ON LUN. SURF.	463.2	53.0	-3	103.0
S-059 20 BAG D.S.B. DISPENSER	G4003.3A		1	CREW STATION - LEFT	1.1	84.9	-14.5	124.5
S-059 TOOL EXTENSION	G4008.		1	NEAR RH CREW STATION	1.8	86.0	24.5	111.0
S-059 TONGS, 32 INCH	G4009.A		1	WITHIN ZONE A8 (1)	1.0	126.8	-5.4	121.7
S-059 TONGS, 32 INCH	G4009.B		1	WITHIN ZONE B1 (1)	1.0	86.0	-4.5	111.0
S-059 GNCMON	G4012.		1	WITHIN ZONE A3 (2)	.6	99.2	-19.5	119.8
S-059 LGE TOOL CARRIER	G4035.		1	WITHIN ZONE A2 (1)	13.8	128.2	-2.0	117.3
S-059 SCOOP, ACJ. SAMPLING	G4035.2		1	NEAR RH CREW STATION	.8	86.0	24.5	111.0
S-059 HAMMER	G4035.3		1	WITHIN ZONE A5 (1)	2.8	98.0	4.5	120.0
S-059 TOGL ASSY, DRIVE TUBE	G4035.5		1	WITHIN ZONE A5 (1)	.1	98.0	4.5	120.0
S-200 PENETROMETER, RECORDING	G4049.		1	WITHIN ZONE A8 (3)	5.8	117.2	-19.7	135.5
S-059 RAKE, LUNAR SAMPLING	G4054.		1	WITHIN ZONE A8 (4)	4.3	117.4	-10.7	130.7
MAGAZINE, 16MM CAC	A0101.1		2	WITHIN ZONE B1 (2)	2.0	84.0	-19.0	103.0
MAGAZINE, ELECT. MASS. CAMERA	A0108.1		2	WITHIN ZONE B1 (3)	2.8	86.0	-19.0	103.0
BRUSH, LENS	A1042.		2	WITHIN ZONE A3 (5)	.2	120.6	-20.5	117.2
CAMERA, POWER PACK ASSY, 16MM LS	A1043.		1	ZONE D1	9.9	62.0	8.0	139.5
STAFF, 16MM CAMERA/PP	R1001.		1	WITHIN ZONE D1 (1)	1.5	62.0	8.0	130.0
70MM CAMERA w/500MM LENS, ETC.	TBD		1	BELOW LH CREW STA	10.7	85.0	-10.5	103.0
TV SYSTEM, LM COLOR	E1001.1		1	WITHIN ZONE F1 (1)	12.9	12.5	14.3	125.0
TV CONTROL UNIT	E1001.2		1	WITHIN ZONE F1 (1)	12.5	12.5	14.3	125.0
LCRU, LUNAR COMM. RELAY UNIT	E1002.1		1	ZONE F1	54.4	6.9	.0	108.0
ANTENNA, HIGH GAIN (CABLE+MAST)	E1002.4		1	ZONE F4	10.3	13.9	-14.3	145.0
ANTENNA, LOW GAIN (CABLE+MAST)	E1002.5		1	ZONE E1	2.5	62.0	-8.0	139.8
BATTERY, LCRU (USED)	E1002.3		1	WITHIN ZONE B1 (4)	8.9	84.9	-14.5	103.0
BATTERY, LCRU (USED)	E1002.3		1	WITHIN ZONE B1 (4)	8.9	84.9	-14.5	103.0
PALLET, LRV AFT CHASSIS	O3067.		1	WITHIN ZONE A1 (2)	29.1	120.0	-7	116.6
WISE DEVICE, DRILL STRING	O3072.		1	WITHIN ZONE A12 (1)	.3	119.0	19.5	128.0
HOLDER, LRV MAP	R1002.		1	WITHIN ZONE D1 (2)	.5	62.0	13.5	126.0
LUNAR SURFACE MAPS, LM	A0114.13		1	WITHIN ZONE D1 (2)	.5	62.0	13.5	126.0
CHECKLIST, EVA CUFF	B1040.		1	CREW STATION - LEFT	.3	84.9	-14.5	124.5
CHECKLIST, EVA CUFF	B1040.		1	CREW STATION - RIGHT	.3	84.9	14.5	124.5
CHRONOGRAPH	A0202.		1	CREW STATION - LEFT	.1	84.9	-14.5	124.5

3.1-38

SNA-B-D-027(III) REV 3

TABLE 3.1-3.1 (CONTINUED)

Amendment 110
7/19/71

LRV MASS PROPERTIES								
THIRD TRAVERSE DEPARTURE - TWO CREW								
			LRV COORDINATES					
DESCRIPTION	STOW. ITEM	REF	NO.	STORAGE LOCATION	WEIGHT	X-C.G.	Y-C.G.	Z-C.G.
CHRONOGRAPH	A0202.		1	CREW STATION - RIGHT	.1	84.9	14.5	124.5
SUBSYSTEM,FECAL CONTAINMENT	80113.		1	CREW STATION - LEFT	.3	84.9	-14.5	124.5
SUBSYSTEM,FECAL CONTAINMENT	80113.		1	CREW STATION - RIGHT	.3	84.9	14.5	124.5
UCTA	80205.		1	CREW STATION - LEFT	.5	84.9	-14.5	124.5
UCTA	80205.		1	CREW STATION - RIGHT	.5	84.9	14.5	124.5
ASSY,8IOBELT	80207.		1	CREW STATION - LEFT	.2	84.9	-14.5	124.5
ASSY,8IOBELT	80207.		1	CREW STATION - RIGHT	.2	84.9	14.5	124.5
ITLSA - CDR	80211.		1	CREW STATION - LEFT	46.9	84.9	-14.5	124.5
ITLSA - LMP	80211.		1	CREW STATION - RIGHT	46.9	84.9	14.5	124.5
HELMET ASSY,PRESSURE	80214.		1	CREW STATION - LEFT	2.6	84.9	-14.5	124.5
HELMET ASSY,PRESSURE	80214.		1	CREW STATION - RIGHT	2.6	84.9	14.5	124.5
HARNESSE,ELEC.SUIT	80215.		1	CREW STATION - LEFT	.5	84.9	-14.5	124.5
HARNESSE,ELEC.SUIT	80215.		1	CREW STATION - RIGHT	.5	84.9	14.5	124.5
HARNESSE,BIOINSTRUMENTATION	80216.		1	CREW STATION - LEFT	.3	84.9	-14.5	124.5
HARNESSE,BIOINSTRUMENTATION	80216.		1	CREW STATION - RIGHT	.3	84.9	14.5	124.5
CARRIER,COMMUNICATION	80217.		1	CREW STATION - LEFT	1.6	84.9	-14.5	124.5
CARRIER,COMMUNICATION	80217.		1	CREW STATION - RIGHT	1.6	84.9	14.5	124.5
POCKET,CHECKLIST	80219.		1	WITHIN ZONE D1 (2)	.2	62.0	13.5	126.0
POCKET,CHECKLIST	80219.		1	WITHIN ZONE D1 (2)	.2	62.0	13.5	126.0
REMOTE CCNTRLO UNIT,PLSS	81001.		1	CREW STATION - LEFT	5.1	84.9	-14.5	124.5
REMOTE CCNTRLO UNIT,PLSS	81001.		1	CREW STATION - RIGHT	5.1	84.9	14.5	124.5
OXYGEN PURGE SYSTEM (OPS)	81012.		1	CREW STATION - LEFT	35.9	84.9	-14.5	124.5
L.E.V.A.	81014.		1	CREW STATION - LEFT	5.6	84.9	-14.5	124.5
L.E.V.A.	81014.		1	CREW STATION - RIGHT	5.6	84.9	14.5	124.5
GLOVES,EVA	81015.		1	CREW STATION - LEFT	2.9	84.9	-14.5	124.5
GLOVES,EVA	81015.		1	CREW STATION - RIGHT	2.9	84.9	14.5	124.5
OVERSHOES,LUNAR	8U018.		1	CREW STATION - LEFT	4.5	84.9	-14.5	124.5
OVERSHOES,LUNAR	81018.		1	CREW STATION - RIGHT	4.5	84.9	14.5	124.5
TETHER,WAIST EVA	81020.6		1	CREW STATION - LEFT	.5	84.9	-14.5	124.5
TETHER,WAIST EVA	81020.7		1	CREW STATION - RIGHT	.5	84.9	14.5	124.5
PLSS/EVCS ASSY	81024.		1	CREW STATION - LEFT	100.9	84.9	-14.5	124.5
PLSS/EVCS ASSY	81025.		1	CREW STATION - RIGHT	100.9	84.9	14.5	124.5

3.1-39

SMA-8-D-027(III) REV 3

TABLE 3.1-3.1 (CONTINUED)

Amendment 110
7/19/71

LRV MASS PROPERTIES								
THIRD TRAVERSE DEPARTURE - TWO CREW								
						LRV COORDINATES		
DESCRIPTION	STOW. ITEM	REF	NO.	STOWAGE LOCATION	WEIGHT	X-C.G.	Y-C.G.	Z-C.G.
GARMENT, LIQUID COOLING	B1030.		1	CREW STATION - LEFT	4.3	84.9	-14.5	124.5
GARMENT, LIQUID COOLING	B1030.		1	CREW STATION - RIGHT	4.3	84.9	14.5	124.5
SAFETY LINE, L.S. (100FT)	B1041.		1	WITHIN ZONE A3 (5)	1.3	120.6	-20.5	117.2
BRUSH, LUNAR DUST	B1045.		1	WITHIN ZONE A1 (3)	1.4	120.7	-4.3	125.7
BAG, L.S. SAFETY LINE	B1047.		1	WITHIN ZONE A3 (5)	.1	120.6	-20.5	117.2
DEVICE, DRINKING (IN SUIT)	B1048.		1	CREW STATION - LEFT	2.8	84.9	-14.5	124.5
DEVICE, DRINKING (IN SUIT)	B1048.		1	CREW STATION - RIGHT	2.8	84.9	14.5	124.5
BUDDY SLS ASSY	B1052.		1	ZONE C1	7.3	99.2	14.5	119.8
OXYGEN PURGE SYSTEM (OPS)	B1059.		1	CREW STATION - RIGHT	35.9	84.9	14.5	124.5
CARRIER, PLSS TCCL (CDR)	B1063.		1	CREW STATION - LEFT	1.5	84.9	-14.5	124.5
CARRIER, PLSS TCCL (LMP)	B1064.		1	CREW STATION - RIGHT	1.5	84.9	14.5	124.5
BIOINSTRUMENTATION ASSY	C0201.		1	CREW STATION - LEFT	1.1	84.9	-14.5	124.5
BIOINSTRUMENTATION ASSY	C0201.		1	CREW STATION - RIGHT	1.1	84.9	14.5	124.5
DOSIMETER, PERSONAL	D0200.		1	CREW STATION - LEFT	.4	84.9	-14.5	124.5
DOSIMETER, PERSONAL	D0200.		1	CREW STATION - RIGHT	.4	84.9	14.5	124.5
LM PILOT	N/A		1	CREW STATION - RIGHT	163.5	84.9	14.5	124.5
COMMANDER	N/A		1	CREW STATION - LEFT	183.0	84.9	-14.5	124.5
S.E.S. CONTAINER	G4004.2		1	WITHIN ZONE A3 (1)	1.0	98.0	-27.5	120.0
S.E.S. CONTAINER	G4004.2		1	WITHIN ZONE A3 (1)	1.0	98.0	-27.5	120.0
CORE TUBES	G4004.4		3	UNDER RM CREW STA	1.8	84.9	14.5	103.0
BAG, SAMPLE RETURN	U3060.		1	WITHIN ZONE A4 (1)	3.2	115.7	-6.6	117.8
S-059 SAMPLE COLLECTION BAG 7	G4056.B		1	WITHIN ZONE A3 (1)	1.8	98.0	-27.5	120.0
S-059 EXTRA COLLECTION BAG 8	G4048.		1	WITHIN ZONE C1 (1)	1.2	98.0	30.6	120.0
L.S. HASSELBLAD CAMERA	A1015.A		1	CREW STATION - LEFT	7.5	84.9	-14.5	124.5
L.S. HASSELBLAD CAMERA	A1015.B		1	CREW STATION - RIGHT	7.5	84.9	14.5	124.5
MAGAZINE, LUNAR SURFACE HASSEL.	A0108.1		1	WITHIN ZONE B1 (3)	1.4	86.0	-19.0	103.0
BAG, GNC/MCN STOWAGE	R1003.		1	WITHIN ZONE A3 (2)	.8	99.2	-19.5	119.8
THIRD TRAVERSE DEPARTURE - TWO CREW					1486.00	71.78	-.52	116.68

3.1-40

SNA-8-D-027(III) REV 3

TABLE 3.1-3.1 (CONTINUED)

LRV MASS PROPERTIES								
THIRD TRAVERSE RETURN - TWO CREW								
						LRV COORDINATES		
DESCRIPTION	STOW. ITEM	REF	NO.	STOWAGE LOCATION	WEIGHT	X-C.G.	Y-C.G.	Z-C.G.
LUNAR ROVER VEHICLE	K1000.		1	DEPLOY ON LUN. SURF.	463.2	53.0	-.3	103.0
S-059 20 BAG O.S.B. DISPENSER	G4003.3A		1	CREW STATION - LEFT	1.1	84.9	-14.5	124.5
S-059 TOOL EXTENSION	G4008.		1	NEAR RH CREW STATION	1.8	86.0	24.5	111.0
S-059 TONGS, 32 INCH	G4009.A		1	WITHIN ZONE A8 (1)	1.0	126.8	-5.4	121.7
S-059 TONGS, 32 INCH	G4009.B		1	WITHIN ZONE B1 (1)	1.0	86.0	-4.5	111.0
S-059 GNOMON	G4012.		1	WITHIN ZONE A3 (2)	.6	99.2	-19.5	119.8
S-059 LGE TOOL CARRIER	G4035.		1	WITHIN ZONE A2 (1)	13.8	128.2	-2.0	117.3
S-059 SCOOP, ADJ. SAMPLING	G4035.2		1	NEAR RH CREW STATION	.8	86.0	24.5	111.0
S-059 HAMMER	G4035.3		1	WITHIN ZONE A5 (1)	2.8	98.0	4.5	120.0
S-059 TOOL ASSY, CRIVE TUBE	G4035.5		1	WITHIN ZONE A5 (1)	.1	98.0	4.5	120.0
S-200 PENETROMETER, RECORDING	G4049.		1	WITHIN ZONE A8 (3)	5.8	117.2	-19.7	135.5
S-059 RAKE, LUNAR SAMPLING	G4054.		1	WITHIN ZONE A8 (4)	4.3	117.4	-10.7	130.7
MAGAZINE, 16MM DAC	A0101.1		2	WITHIN ZONE B1 (2)	2.0	84.0	-19.0	103.0
MAGAZINE, ELECT. MASS. CAMERA	A0108.1		2	WITHIN ZONE B1 (3)	2.8	86.0	-19.0	103.0
BRUSH, LENS	A1042.		2	WITHIN ZONE A3 (5)	.2	120.6	-20.5	117.2
CAMERA, POWER PACK ASSY, 16MM LS	A1043.		1	ZONE D1	9.9	62.0	8.0	139.5
STAFF, 16MM CAMERA/PP	R1001.		1	WITHIN ZONE D1 (1)	1.5	62.0	8.0	130.0
70MM CAMERA W/500MM LENS, ETC.	TBD		1	BELOW LH CREW STA	10.7	85.0	-10.5	103.0
TV SYSTEM, LM CCLOR	E1001.1		1	WITHIN ZONE F1 (1)	12.9	12.5	14.3	125.0
TV CONTROL UNIT	E1001.2		1	WITHIN ZONE F1 (1)	12.5	12.5	14.3	125.0
LCRU, LUNAR COMM. RELAY UNIT	E1002.1		1	ZONE F1	54.4	6.9	.0	108.0
ANTENNA, HIGH GAIN (CABLE+MAST)	E1002.4		1	ZONE F4	10.3	13.9	-14.3	145.0
ANTENNA, LOW GAIN (CABLE+MAST)	E1002.5		1	ZONE E1	2.5	62.0	-8.0	139.8
BATTERY, LCRU (USED)	E1002.3		1	WITHIN ZONE B1 (4)	8.9	84.9	-14.5	103.0
BATTERY, LCRU (USED)	E1002.3		1	WITHIN ZONE B1 (4)	8.9	84.9	-14.5	103.0
PALLET, LRV AFT CHASSIS	O3067.		1	WITHIN ZONE A1 (2)	29.1	120.0	-.7	116.6
WISE DEVICE, DRILL STRING	O3072.		1	WITHIN ZONE A12 (1)	.3	119.0	19.5	128.0
HOLDER, LRV MAP	R1002.		1	WITHIN ZONE D1 (2)	.5	62.0	13.5	126.0
LUNAR SURFACE MAPS, LM	A0114.13		1	WITHIN ZONE D1 (2)	.5	62.0	13.5	126.0
CHECKLIST, EVA CUFF	B1040.		1	CREW STATION - LEFT	.3	84.9	-14.5	124.5
CHECKLIST, EVA CUFF	B1040.		1	CREW STATION - RIGHT	.3	84.9	14.5	124.5
CHRONOGRAPH	A0202.		1	CREW STATION - LEFT	.1	84.9	-14.5	124.5

3.1-41

SNA-8-D-027(III) REV 3

TABLE 3.1-3.1 (CONTINUED)

Amendment 110
7/19/71

LRV MASS PROPERTIES								
THIRD TRAVERSE RETURN - TWO CREW								
						LRV COORDINATES		
DESCRIPTION	STOW. ITEM	REF	NO.	STOWAGE LOCATION	WEIGHT	X-C.G.	Y-C.G.	Z-C.G.
CHRONOGRAPH	A0202.		1	CREW STATION - RIGHT	.1	84.9	14.5	124.5
SUBSYSTEM, FECAL CONTAINMENT	B0113.		1	CREW STATION - LEFT	.3	84.9	-14.5	124.5
SUBSYSTEM, FECAL CONTAINMENT	B0113.		1	CREW STATION - RIGHT	.3	84.9	14.5	124.5
UCTA	B0205.		1	CREW STATION - LEFT	.5	84.9	-14.5	124.5
UCTA	B0205.		1	CREW STATION - RIGHT	.5	84.9	14.5	124.5
ASSY, BIOBELT	B0207.		1	CREW STATION - LEFT	.2	84.9	-14.5	124.5
ASSY, BIOBELT	B0207.		1	CREW STATION - RIGHT	.2	84.9	14.5	124.5
ITLSA - CDR	B0211.		1	CREW STATION - LEFT	46.9	84.9	-14.5	124.5
ITLSA - LMP	B0211.		1	CREW STATION - RIGHT	46.9	84.9	14.5	124.5
HELMET ASSY, PRESSURE	B0214.		1	CREW STATION - LEFT	2.6	84.9	-14.5	124.5
HELMET ASSY, PRESSURE	B0214.		1	CREW STATION - RIGHT	2.6	84.9	14.5	124.5
HARNESS, ELEC. SUIT	B0215.		1	CREW STATION - LEFT	.5	84.9	-14.5	124.5
HARNESS, ELEC. SUIT	B0215.		1	CREW STATION - RIGHT	.5	84.9	14.5	124.5
HARNESS, BIOINSTRUMENTATION	B0216.		1	CREW STATION - LEFT	.3	84.9	-14.5	124.5
HARNESS, BIOINSTRUMENTATION	B0216.		1	CREW STATION - RIGHT	.3	84.9	14.5	124.5
CARRIER, COMMUNICATION	B0217.		1	CREW STATION - LEFT	1.6	84.9	-14.5	124.5
CARRIER, COMMUNICATION	B0217.		1	CREW STATION - RIGHT	1.6	84.9	14.5	124.5
POCKET, CHECKLIST	B0219.		1	WITHIN ZONE D1 (2)	.2	62.0	13.5	126.0
POCKET, CHECKLIST	B0219.		1	WITHIN ZONE D1 (2)	.2	62.0	13.5	126.0
REMOTE CONTROL UNIT, PLSS	B1001.		1	CREW STATION - LEFT	5.1	84.9	-14.5	124.5
REMOTE CONTROL UNIT, PLSS	B1001.		1	CREW STATION - RIGHT	5.1	84.9	14.5	124.5
OXYGEN PURGE SYSTEM (OPS)	B1012.		1	CREW STATION - LEFT	35.9	84.9	-14.5	124.5
L.E.V.A.	B1014.		1	CREW STATION - LEFT	5.6	84.9	-14.5	124.5
L.E.V.A.	B1014.		1	CREW STATION - RIGHT	5.6	84.9	14.5	124.5
GLOVES, EVA	B1015.		1	CREW STATION - LEFT	2.9	84.9	-14.5	124.5
GLOVES, EVA	B1015.		1	CREW STATION - RIGHT	2.9	84.9	14.5	124.5
OVERSHOES, LUNAR	B0018.		1	CREW STATION - LEFT	4.5	84.9	-14.5	124.5
OVERSHOES, LUNAR	B0018.		1	CREW STATION - RIGHT	4.5	84.9	14.5	124.5
TETHER, WAIST EVA	B1020.6		1	CREW STATION - LEFT	.5	84.9	-14.5	124.5
TETHER, WAIST EVA	B1020.7		1	CREW STATION - RIGHT	.5	84.9	14.5	124.5
PLSS/EVCS ASSY	B1024.		1	CREW STATION - LEFT	100.9	84.9	-14.5	124.5
PLSS/EVCS ASSY	B1025.		1	CREW STATION - RIGHT	100.9	84.9	14.5	124.5

3.1-42

SNA-B-D-027(III) REV 3

TABLE 3.1-3.1 (CONTINUED)

LRV MASS PROPERTIES								
THIRD TRAVERSE RETURN - TWO CREW								
LRV COORDINATES								
DESCRIPTION	STOW. ITEM	REF	NO.	STORAGE LOCATION	WEIGHT	X-C.G.	Y-C.G.	Z-C.G.
GARMENT, LIQUID COOLING	B1030.		1	CREW STATION - LEFT	4.3	84.9	-14.5	124.5
GARMENT, LIQUID COOLING	B1030.		1	CREW STATION - RIGHT	4.3	84.9	14.5	124.5
SAFETY LINE, L.S. (100FT)	B1041.		1	WITHIN ZONE A3 (5)	1.3	120.6	-20.5	117.2
BRUSH, LUNAR DUST	B1045.		1	WITHIN ZONE A1 (3)	1.4	120.7	-4.3	125.7
BAG, L.S. SAFETY LINE	B1047.		1	WITHIN ZONE A3 (5)	.1	120.6	-20.5	117.2
DEVICE, DRINKING (IN SUIT)	B1048.		1	CREW STATION - LEFT	2.8	84.9	-14.5	124.5
DEVICE, DRINKING (IN SUIT)	B1048.		1	CREW STATION - RIGHT	2.8	84.9	14.5	124.5
BUDDY SLSS ASSY	H1052.		1	ZONE C1	7.3	99.2	14.5	119.8
OXYGEN PURGE SYSTEM (UPS)	H1059.		1	CREW STATION - RIGHT	35.9	84.9	14.5	124.5
CARRIER, PLSS TCCL (CDR)	B1063.		1	CREW STATION - LEFT	1.5	84.9	-14.5	124.5
CARRIER, PLSS TCCL (LMP)	B1064.		1	CREW STATION - RIGHT	1.5	84.9	14.5	124.5
BIOINSTRUMENTATION ASSY	C0201.		1	CREW STATION - LEFT	1.1	84.9	-14.5	124.5
BIOINSTRUMENTATION ASSY	C0201.		1	CREW STATION - RIGHT	1.1	84.9	14.5	124.5
DOSIMETER, PERSONAL	D0200.		1	CREW STATION - LEFT	.4	84.9	-14.5	124.5
DOSIMETER, PERSONAL	D0200.		1	CREW STATION - RIGHT	.4	84.9	14.5	124.5
LM PILOT	N/A		1	CREW STATION - RIGHT	163.5	84.9	14.5	124.5
COMMANDER	N/A		1	CREW STATION - LEFT	183.0	84.9	-14.5	124.5
BAG, SAMPLE RETURN	D3060.		1	WITHIN ZONE A4 (1)	3.2	115.7	-6.6	117.8
SAMPLES IN BAG C3060.	N/A		1	WITHIN ZONE A4 (1)	26.3	115.7	-6.6	117.8
S-059 SAMPLE COLLECTION BAG 7	G4056.b		1	WITHIN ZONE A3 (1)	1.8	98.0	-27.5	120.0
SAMPLES IN BAG 7	N/A		1	WITHIN ZONE A3 (1)	15.0	98.0	-27.5	120.0
S-059 EXTRA COLLECTION BAG 8	G4048.		1	WITHIN ZONE C1 (1)	1.2	98.0	30.6	120.0
SAMPLES IN BAG 8	N/A		1	WITHIN ZONE C1 (1)	9.8	98.0	30.6	120.0
CURE TUBE+SAMPLES IN BAG 8	N/A		1	WITHIN ZONE C1 (1)	5.7	98.0	30.6	120.0
L.S. HASSELBLAD CAMERA	A1015.A		1	CREW STATION - LEFT	7.5	84.9	-14.5	124.5
L.S. HASSELBLAD CAMERA	A1015.B		1	CREW STATION - RIGHT	7.5	84.9	14.5	124.5
MAGAZINE, LUNAR SURFACE HASSEL.	A0108.1		1	WITHIN ZONE B1 (3)	1.4	86.0	-19.0	103.0
BAG, GENERAL STOWAGE	R1003.		1	WITHIN ZONE A3 (2)	.8	99.2	-19.5	119.8
THIRD TRAVERSE RETURN - TWO CREW					1539.00	73.00	-5.56	116.78

3.1-43

SNA-8-D-027(III) REV 3

XA COORDINATES

TABLE 3.1-4

CSM 112 LEV DETAIL (TILTED) MASS PROPERTIES HIGH ALTITUDE ABORT
MASS PROPERTIES

The following information applies to Tables 3.1-4 and 3.1-5.

Delta Z	=	0.800 in.
LES motor tilted angles	Delta =	2.240 deg.
(Delta includes 0.3 deg. for down range dispersions)	Sigma =	268.996 deg.
LES motor tilted confluence point	X =	1222.300 in.
	Y =	0.011 in.
	Z =	0.282 in.
PCM motor tilted angels	Delta =	89.150 deg.
	Sigma =	270.000 deg.
PCM motor tilted confluence point	X =	1429.000 in.
	Y =	0.134 in.
	Z =	3.348 in.



U
N
I
T
E
D
S
T
A
T
E
S
O
F
A
M
E
R
I
C
A



Amendment 111
7/22/71

XA COORDINATES TABLE 3.1-4 (CONTINUED)
CSM 112 LEV DETAIL (TILTED) MASS PROPERTIES - HIGH ALTITUDE A3DR1

DESCRIPTION	S	WEIGHT POUNDS	C. G. INCHES			INERTIAS SLUG-FT ²			PRODUCTS SLUG-FT ²			DISPERSIONS LB/IN			
			X	Y	Z	I _{XX}	I _{YY}	I _{ZZ}	P _{XY}	P _{XZ}	P _{YZ}	DW	DX	DY	DZ
TIME = 0.0	+	21953.7	1148.0	.0	3.6	6772	109876	109358	181	-1025	-7	.0	.0	.0	.0
0.5	+	21594.7	1145.5	.0	3.7	6768	107927	107409	178	-1000	-7	.0	.0	.0	.0
1.0	+	21139.7	1142.3	.0	3.7	6760	105510	104993	175	-969	-7	.0	.0	.0	.0
1.5	+	20719.7	1139.2	.0	3.8	6752	103191	102674	172	-939	-7	.0	.0	.0	.0
2.0	+	20294.7	1135.9	.0	3.8	6742	100752	100236	169	-907	-7	.0	.0	.0	.0
2.5	+	19914.7	1132.9	.0	3.9	6732	98490	97974	166	-877	-7	.0	.0	.0	.0
3.0	+	19564.7	1130.0	.0	3.9	6722	96332	95817	163	-849	-7	.0	.0	.0	.0
3.5	+	19284.7	1127.6	-.0	3.9	6714	94554	94039	161	-825	-7	.0	.0	.0	.0
4.0	+	19104.7	1126.0	-.0	4.0	6708	93384	92869	160	-809	-7	.0	.0	.0	.0
4.5	+	19004.7	1125.2	-.0	4.0	6704	92725	92211	159	-801	-7	.0	.0	.0	.0
5.0	+	18934.7	1124.5	-.0	4.0	6702	92260	91746	158	-794	-7	.0	.0	.0	.0
5.5	+	18864.7	1123.9	-.0	4.0	6699	91792	91278	158	-788	-7	.0	.0	.0	.0
6.0	+	18829.7	1123.6	-.0	4.0	6698	91557	91042	157	-785	-7	.0	.0	.0	.0
6.5	+	18811.7	1123.4	-.0	4.0	6697	91435	90921	157	-783	-7	.0	.0	.0	.0
7.0	+	18794.7	1123.3	-.0	4.0	6697	91320	90806	157	-782	-7	.0	.0	.0	.0
7.5	+	18778.7	1123.1	-.0	4.0	6696	91212	90698	157	-780	-7	.0	.0	.0	.0

3.1-44.1

SNA-8-D-027(III) REV 3



Amendment 111
7/22/71

TABLE 3.1-4 (CONTINUED)
CSM 112 LEV DETAIL (TILTED) MASS PROPERTIES - HIGH ALTITUDE 430RT

DESCRIPTION	S	WEIGHT POUNDS	C. G. INCHES			INERTIAS SLUG-FT ²			PRODUCTS SLUG-FT ²		
			X	Y	Z	Ixx	Iyy	Izz	Pxy	Pxz	Pyz
TIME = 8.0		18766.7	1123.0	-0.0	4.0	6696	91131	90617	157	-778	-7
= 9.0		18756.7	1122.9	-0.0	4.0	6696	91063	90549	157	-777	-7
CM W/O DUCKING MCH	+	12644.4	1040.1	-0.1	5.7	5913	5230	4683	46	-397	-7
FWD HEAT SHIELD	-	310.0	1094.3	-0.5	0.8	64	26	23	0	0	0
CM W/O DCK.MECH.HEAT SHLD		12334.4	1038.7	-0.1	5.8	5847	5000	4458	47	-378	-7
DROGUE + DISC.	-	80.8	1089.0	0.0	-23.9	1	1	0	0	0	0
CM AT MAIN CHUTE DEPLOY		12253.6	1038.4	-0.1	6.0	5830	4939	4413	47	-352	-7
PILOT CHUTE + MRSR	-	44.5	1089.9	5.9	-5.8	2	2	1	0	0	0
MAIN CHUTE PACKS	-	401.4	1089.1	-0.4	3.5	62	22	43	0	0	0
RCS OXID SYSTEM A	-	78.3	1022.6	26.6	59.8	0	0	0	0	0	0
RCS OXID SYSTEM B	-	78.3	1022.6	2.3	65.5	0	0	0	0	0	0
RCS FUEL SYSTEM A	-	44.2	1022.6	-38.7	52.8	0	0	0	0	0	0
RCS FUEL SYSTEM B	-	44.2	1022.6	-52.8	38.7	0	0	0	0	0	0
CM AT IMPACT		11562.7	1036.7	0.0	4.9	5568	4502	4048	40	-320	1

DISPERSIONS LB/IN			
DW	DX	DY	DZ
.0	.0	.0	.0
.0	.0	.0	.0
.0	.0	.0	.0
.0	.0	.0	.0
.0	.0	.0	.0
.0	.0	.0	.0
.0	.0	.0	.0
.0	.0	.0	.0
.0	.0	.0	.0
.0	.0	.0	.0
.0	.0	.0	.0
.0	.0	.0	.0
.0	.0	.0	.0
.0	.0	.0	.0
.0	.0	.0	.0
.0	.0	.0	.0
.0	.0	.0	.0
.0	.0	.0	.0
.0	.0	.0	.0

3.1-44.2

SNA-8-D-027(III) REV 3

N
 U
 M
 E
 R
 I
 C
 A
 L
 R
 E
 C
 O
 R
 D
 S



Amendment 111
7/22/71

XA COORDINATES TABLE 3.1-5
CSM 112 LEV DETAIL (TILTED) MASS PROPERTIES - PAD ABORT

DESCRIPTION	S	WEIGHT POUNDS	C. G. INCHES			INERTIAS SLUG-FT ²			PRODUCTS SLUG-FT ²			DISPERSIONS LB/IN			
			X	Y	Z	I _{XX}	I _{YY}	I _{ZZ}	P _{XY}	P _{XZ}	P _{YZ}	D _W	O _X	D _Y	O _Z
TIME = 0.0	+	21953.7	1148.0	.0	3.0	6767	109881	109352	169	-1030	9	.0	.0	.0	.0
0.5	+	21585.6	1145.6	.0	3.7	6755	107895	107373	171	-991	7	.0	.0	.0	.0
1.0	+	21121.5	1142.4	.0	3.7	6740	105445	104929	171	-946	5	.0	.0	.0	.0
1.5	+	20692.4	1139.4	.0	3.7	6725	103095	102586	172	-903	4	.0	.0	.0	.0
2.0	+	20258.3	1136.1	.0	3.7	6708	100628	100127	172	-859	2	.0	.0	.0	.0
2.5	+	19869.2	1133.2	-.0	3.7	6691	98340	97845	172	-818	0	.0	.0	.0	.0
3.0	+	19510.1	1130.3	-.0	3.7	6673	96159	95671	172	-778	0	.0	.0	.0	.0
3.5	+	19220.9	1127.9	-.0	3.8	6657	94358	93876	173	-744	-2	.0	.0	.0	.0
4.0	+	19031.9	1126.4	-.0	3.7	6644	93165	92690	174	-718	-4	.0	.0	.0	.0
4.5	+	18922.8	1125.6	-.0	3.7	6633	92481	92013	176	-698	-5	.0	.0	.0	.0
5.0	+	18837.3	1125.1	-.0	3.7	6618	91974	91512	172	-674	-4	.0	.0	.0	.0
5.5	+	18751.9	1124.5	-.0	3.7	6603	91465	91009	168	-651	-3	.0	.0	.0	.0
6.0	+	18701.6	1124.3	-.0	3.6	6589	91187	90737	164	-631	-2	.0	.0	.0	.0
6.5	+	18668.2	1124.2	-.0	3.6	6576	91023	90579	160	-612	-2	.0	.0	.0	.0
7.0	+	18635.8	1124.1	-.0	3.5	6563	90866	90427	157	-593	-1	.0	.0	.0	.0
7.5	+	18604.4	1124.1	.0	3.5	6550	90715	90283	153	-574	0	.0	.0	.0	.0

3.1-45

SMA-8-D-027(III) REV 3



Amendment 111
7/22/71

XA COORDINATES
TABLE 3.1-5 (CONTINUED)
CSM 112 LEV DETAIL (TILTED) MASS PROPERTIES - PAD ABORT

DESCRIPTION	S	WEIGHT POUNDS	C. G. INCHES			INERTIAS SLUG-FT ²			PRODUCTS SLUG-FT ²		
			X	Y	Z	IXX	IYY	IZZ	PXY	PXZ	PYZ
TIME = 8.0		18576.9	1124.0	.0	3.5	6537	90591	90165	150	-555	0
= 9.0		18551.5	1124.0	.0	3.4	6523	90480	90060	146	-537	1
= 10.0		18535.9	1124.1	.0	3.4	6511	90436	90022	143	-519	2
= 11.0		18529.7	1124.1	.0	3.4	6505	90420	90005	137	-514	5
= 12.0		18523.4	1124.2	.1	3.3	6500	90403	89988	130	-507	8
= 13.0		18517.1	1124.2	.1	3.3	6495	90387	89971	124	-501	10
CM W/O DUCKING MCH	+	12399.4	1040.4	.0	4.7	5710	5067	4610	46	-349	13
FWD HEAT SHIELD	-	310.0	1094.3	-.5	.8	64	26	23	0	0	0
CM W/O DCK.MECH.HEAT SHLD		12089.4	1039.0	.1	4.8	5645	4840	4388	48	-334	12
DRUGUE + DISC.	-	80.8	1089.0	.0	-23.9	1	1	0	0	0	0
CM AT MAIN CHUTE DEPLOY		12008.6	1038.7	.1	5.0	5629	4781	4344	48	-309	12
PILUT CHUTE+MRSK	-	44.5	1089.9	5.9	-5.8	2	2	1	0	0	0
MAIN CHUTE PACKS	-	401.4	1087.1	-.4	3.5	62	22	43	0	0	0
CM AT IMPACT		11562.7	1036.7	.0	4.9	5563	4500	4045	47	-319	13

DISPERSIONS LB/IN			
DW	DX	DY	DZ
.0	.0	.0	.0
.0	.0	.0	.0
.0	.0	.0	.0
.0	.0	.0	.0
.0	.0	.0	.0
.0	.0	.0	.0
.0	.0	.0	.0
.0	.0	.0	.0
.0	.0	.0	.0
.0	.0	.0	.0
.0	.0	.0	.0
.0	.0	.0	.0
.0	.0	.0	.0
.0	.0	.0	.0
.0	.0	.0	.0
.0	.0	.0	.0
.0	.0	.0	.0
.0	.0	.0	.0

3.1-45.1

SNA-8-D-027(III) REV 3

U
N
I
T
E
D
S
T
A
T
E
S
O
F
A
M
E
R
I
C
A
S
P
A
C
E
S
H
I
P
C
O
R
P
O
R
A
T
I
O
N

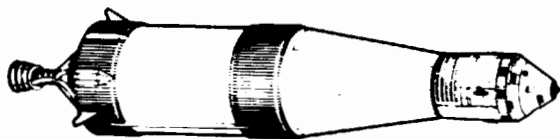

Amendment 110
7/19/71

LV COORDINATES TABLE 3.1-6
SIVR EXPECTED SEQUENTIAL MASS PROPERTIES

DESCRIPTION	S	WEIGHT POUNDS	C. G. INCHES			INERTIAS SLUG-FT ²			PRODUCTS SLUG-FT ²		
			X	Y	Z	I _{XX}	I _{YY}	I _{ZZ}	P _{XY}	P _{XZ}	P _{YZ}
SIVB POST E.O.I.		206625.2	2833.6	1.0	-0.8	39720	950568	948066			
CSM		66924.6	3690.5	5.0	4.7	36397	80079	81729			
LM IN SLA		36237.7	3340.1	.4	-0.9	25859	27364	26117			
SIVB+CSM+LM POST E.O.I.		309787.7	3078.0	1.6	.4	152520	9677959	9675711			
SIVR PRE T.O.I.		204125.2	2831.2	1.0	-0.8	19047	928019	925856			
CSM PRE T.O.I.		66921.2	3690.5	5.0	4.7	36399	80086	81741			
LM IN SLA		36237.7	3340.1	.4	-0.9	25859	27364	26117			
SIVB+CSM+LM PRE T.O.I.		307284.1	3078.4	1.8	.4	191841	9674807	9672905			
SIVR POST T.O.I.		40822.2	2938.4	4.5	-3.7	18476	605058	602626			
CSM POST T.O.I.		66921.2	3690.5	5.0	4.7	36399	80086	81741			
LM IN SLA		36237.7	3340.1	.4	-0.9	25859	27364	26117			
SIVB+CSM+LM POST T.O.I.		143981.1	3389.1	3.7	.9	151271	3833158	3830828			
SIVR (EXCL. SLA PANELS)		36293.2	2905.4	5.1	-3.9	12244	441907	439690			
LM IN SLA		36237.7	3340.1	.4	-0.9	25859	27364	26117			
SIVR+LM PRE LOCKING		72530.9	3122.6	2.0	-2.4	110225	1208775	1205364			

NOTE: Products of inertia are not presently available for the S-IVB. This table will be updated to include products of inertia when data is available.

NASA-MSC

3.1-46

SNA-8-D-027(III) REV 3

M M M E E E L L E E E E E H H E E L L L

TABLE 3.1-7

CSM 112 CONSUMABLES WEIGHT CHANGE SUMMARY

(To be used in conjunction with CSM sequential mass properties Table 3.1-2).

From	EVENT	To	Consumable	Weight Change (Pounds)	Amount Remaining (Pounds)	Total Usage (Pounds)
Earth Orbit		Pre Trans/Dock	SM-Hydrogen			
			Tank 1 & 2	-1.6	53.6	-1.6
			Tank 3	-0.6	27.0	-0.6
			SM-Oxygen			
			Tank 1 & 2	-7.5	625.7	-7.5
			Tank 3	-0.7	315.9	-0.7
			CM-Waste H ₂ O CM-Potable H ₂ O	+0.8 +6.0	35.8 36.0	
Pre Trans/Dock		Post Trans/Dock	SM-RCS	-70.6	1,265.7	-70.6
Post Trans/Dock		Pre L.O.I.	SM-Hydrogen			
			Tank 1 & 2	-4.7	48.9	-6.3
			Tank 3	-9.3	17.7	-9.9
			SM-Oxygen			
			Tank 1 & 2	-61.4	564.3	-68.9
			Tank 3	-81.5	234.4	-82.2
			SM-RCS	-110.2	1,155.5	-180.8
			CM-Waste H ₂ O	+8.2	44.0	
			CM-LiOH	+24.0	24.0	
			CM-Food Fecal	-6.2 +2.0		-6.2 2.0
Pre L.O.I.		Post L.O.I.	SM-SPS	-26,300.2	14,179.1	-26,300.2
Post L.O.I.		Pre D.O.I.	SM-Hydrogen			
			Tank 1 & 2	-0.8	48.1	-7.1
			Tank 3	-0.1	17.6	-10.0
			SM-Oxygen			
			Tank 1 & 2	-6.8	557.5	-75.7
			Tank 3	-1.3	233.1	-83.5
			SM-RCS	-41.9	1,113.6	-222.7

TABLE 3.1-7 (CONTINUED)

CSM 112 CONSUMABLES WEIGHT CHANGE SUMMARY

(To be used in conjunction with CSM sequential mass properties Table 3.1-2).

EVENT		Consumable	Weight Change (Pounds)	Amount Remaining (Pounds)	Total Usage (Pounds)
From	To				
Pre D.O.I.	Post D.O.I.	SM-SPS	-1,561.4	12,617.7	-27,861.6
Post D.O.I.	CSM/LM Sep.	SM-Hydrogen			
		Tank 1 & 2	-4.0	44.1	-11.1
		Tank 3	-0.8	16.8	-10.8
		SM-Oxygen			
		Tank 1 & 2	-22.9	534.6	-98.6
		Tank 3	-13.5	219.6	-97.0
		SM-RCS	-114.7	998.9	-337.4
		CM-LiOH	+6.0	30.0	
		CM-Food	-3.8		-10.0
		Fecal	+3.0	5.0	
CSM/LM Sep.	Pre Circularization	SM-Hydrogen			
		Tank 1 & 2	-0.1	44.0	-11.2
		Tank 3	-0.1	16.7	-10.9
		SM-Oxygen			
		Tank 1 & 2	-0.7	533.9	-99.3
		Tank 3	-2.3	217.3	-99.3
		SM-RCS	-23.7	975.2	-361.1
Pre Circularization	Post Circularization	SM-SPS	-277.9	12,339.8	-28,139.5
Post Circularization	Pre Plane Charge	SM-Hydrogen			
		Tank 1 & 2	-11.5	32.5	-22.7
		Tank 3	-2.5	14.2	-13.4
		SM-Oxygen			
		Tank 1 & 2	-83.6	450.3	-182.9
		Tank 3	-33.4	183.9	-132.7
		SM-RCS	-112.0	863.2	-473.1
		Fecal	+3.0	8.0	

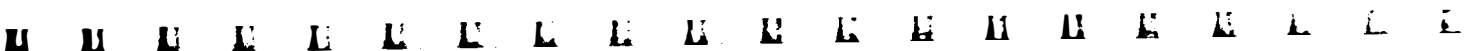

TABLE 3.1-7 (CONTINUED)

CSM 112 CONSUMABLES WEIGHT CHANGE SUMMARY

(To be used in conjunction with CSM sequential mass properties Table 3.1-2).

From	EVENT	To	Consumable	Weight Change (Pounds)	Amount Remaining (Pounds)	Total Usage (Pounds)
Pre Plane Change		Post Plane Change	SM-SPS	-1,133.8	11,206.0	-29,273.3
Post Plane Change		CSM/ASCT Dock	SM-Hydrogen			
			Tank 1 & 2	-1.4	31.1	-24.1
			Tank 3	-0.3	13.9	-13.7
			SM-Oxygen			
			Tank 1 & 2	-10.6	439.7	-193.5
			Tank 3	-4.0	179.9	-136.7
			SM-RCS	-87.1	776.1	-560.2
			CM-Food	-4.3		-14.3
			CM-L10H	+12.0	42.0	
			CM-Fecal	+3.1	11.1	
CSM/ASCT Dock		Pre Orbit Shaping	SM-Hydrogen			
			Tank 1 & 2	-8.4	22.7	-32.5
			Tank 3	-1.9	12.0	-15.6
			SM-Oxygen			
			Tank 1 & 2	-60.5	379.2	-254.0
			Tank 3	-33.0	146.9	-169.7
			SM-RCS	-55.5	720.6	-615.7
			CM-L10H	+5.0	47.0	
			CM-Fecal	+3.0	14.1	
			CM-Food	-3.8		-18.1
Pre Orbit Shaping		Post Orbit Shaping	SM-SPS	-243.9	10,962.1	-29,517.2
Post Orbit Shaping		Pre T.E.I.	SM-Hydrogen			
			Tank 1 & 2	-0.4	22.3	-32.9
			Tank 3	-0.1	11.9	-15.7
			SM-Oxygen			
			Tank 1 & 2	-2.8	376.4	-256.8
			Tank 3	-1.7	145.2	-171.4
			SM-RCS	-36.3	684.3	-652.0

TABLE 3.1-7 (CONCLUDED)

CSM 112 CONSUMABLES WEIGHT CHANGE SUMMARY

(To be used in conjunction with CSM sequential mass properties Table 3.1-2).

From	EVENT	To	Consumable	Weight Change (Pounds)	Amount Remaining (Pounds)	Total Usage (Pounds)
Pre T.E.I.		Post T.E.I.	SM-SPS	-9,366.8	1,595.3	-38,884.0
Post T.E.I.		SM Jettison	SM-Hydrogen			
			Tank 1 & 2	-10.3	12.0	-43.2
			Tank 3	-2.9	9.0	-18.6
			SM-Oxygen			
			Tank 1 & 2	-82.9	293.5	-339.7
			Tank 3	-49.2	96.0	-220.6
			SM-RCS	-117.8	566.5	-769.8
			CM-LiOH	+13.0	60.0	
			CM-Food	-7.3		-25.4
			CM-Fecal	+4.6	18.7	
SM Jettison		CM @ Entry	CM-RCS	-11.6	233.4	-11.6
CM @ Entry		CM @ M.C. Deploy	CM-RCS	-30.7	202.7	-42.3
CM @ M.C. Deploy		CM @ Impact	CM-RCS	-202.7	0.0	-245.0

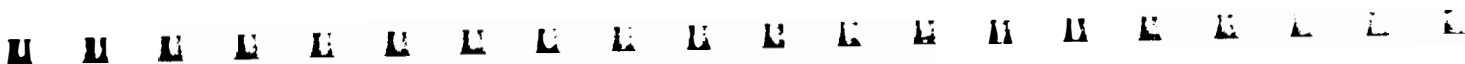

TABLE 3.1-8

LM-10 CONSUMABLES CHANGE SUMMARY

(To be used in conjunction with the LM sequential mass properties Table 3.1-3)

EVENT		Consumable	Weight	Amount	Total
From	To		Change	Remaining	Usage
			(Pounds)	(Pounds)	(Pounds)
Earth Orbit	CSM/LM Separation	D/S-Oxygen	-1.0	92.8	-1.0
		D/S-Water	-12.0	396.0	-12.0
		LM-RCS	-5.0	600.4	-5.0
CSM/LM Separation	Pre P.D.I.	D/S-Oxygen	-0.6	92.2	-1.6
		D/S-Water	-23.0	373.0	-35.0
		LM-RCS	-50.7	549.7	-55.7
Pre P.D.I.	LM @ Touchdown	D/S-Oxygen	-0.1	92.1	-1.7
		D/S-Water	-2.0	371.0	-37.0
		LM-RCS	-90.0	459.7	-145.7
		LM-DPS	-18,790.5	694.8	-18,790.5
LM @ Touchdown	A/S @ Lift-Off	LM-RCS	-5.0	454.7	-150.7
A/S @ Lift-Off	A/S in Orbit	LM-APS	-4,942.7	280.1	4,942.7
A/S in Orbit	A/S Pre T.P.I.	A/S-Water	-8.0	77.0	-8.0
		A/S-Oxygen	-0.2	4.8	-0.2
		LM-RCS	-44.6	410.1	-195.3
A/S Pre T.P.I.	A/S Post T.P.I.	LM-APS	-35.4	244.7	4,978.1
A/S Post T.P.I.	A/S @ Docking	A/S-Water	-7.0	70.0	-15.0
		A/S-Oxygen	-0.3	4.3	-0.5
		LM-RCS	-70.3	339.8	-265.6
A/S @ Docking	A/S Jettison	A/S-Water	-20.0	50.0	-35.0



TABLE 3.1-9
MISSION J-1 COMMAND MODULE STOWAGE VOLUME CENTROID

Amendment 112
7/24/71

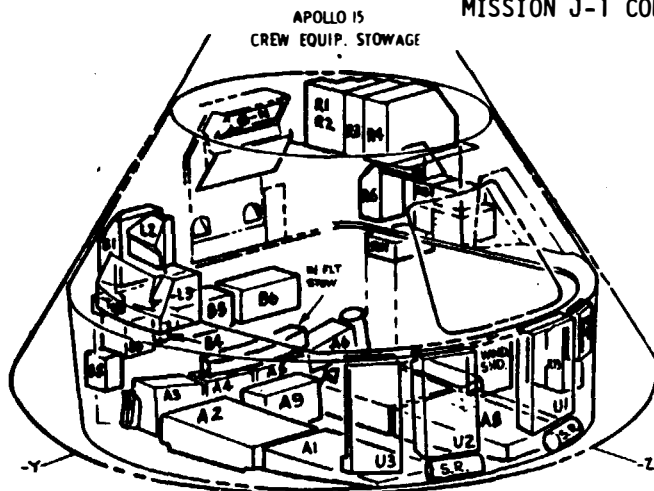

S/C 112 "J-SERIES" LAUNCH STOWAGE LIST

A-1
TV CAMERA, COLOR
ZOOM LENS WITH COVER
TV MONITOR
TV MONITOR CABLE
TV POWER CABLE
TV CAMERA BRIGHTNESS
TV MOUNTING BRACKET
16MM CAMERA SIXTANT ADAPTER
70MM CAMERA ADAPTER
70MM REMOTE CONTROL CABLE
16MM FILM MAGS AND 2 BAGS - 7
70MM FILM MAGAZINES AND BAG - 2
2 SPEED INTERVAL TIMER
VOICE RECORDER/CASS. & BATT.
UV FILTER ASSY (105000 LENS)
UV CAMERA MOUNT
UV 70MM MAGAZINE
HFLIGHT RETAINER STRAPS - 3
CM TOWELS (RED, WHITE, BLUE) - 9

A-2
PPK'S - 3
TISSUE DISPENSERS - 8
FECAL CONTAINMENT SUBSYSTEM - 3
HEAD REST PADS - 3
HEEL CLIPS - 3 PR.
HEEL RESTRAINT CONTAINER
JETTISON STORAGE BAGS - 3 (2 OFF*)

EVA GLOVES (CMP)
EVA EQUIPMENT CONTAINER
PCA BRACKET
WHISKY TETHER
TV CREWMAN TETHER
OPS PCA STRAPS - 4
OPS CONTROL VALVE
H₂O CONNECTOR PLUGS
ENTRY TIE-DOWN ROPES AND BAG - 5
ENTRY BOOTS CONTAINER
CANCE ASSY. (PANEL 603)

VACUUM CLEANER DECON. BAG.
VACUUM CLEAN BAGS - 2
VACUUM CLEAN POWER CABLE

TOP OF A-2
DECONTAMINATION BAGS*
TSA DECONTAMINATION BAG*
CONTINGENCY LUNAR SAMPLE RETURN
TIE DOWN ROPES & BAG - 5
LUNAR SAMPLE (B/SLS AREA)
PERITRONOMETER DRUM
40 LB SAMPLE - 2

A-3
CO₂ ABSORBERS - 4
FIRE EXTINGUISHER (ON A-3)

A-4
CO₂ ABSORBERS - 4

A-5
CO₂ ABSORBERS - 4

A-6
CO₂ ABSORBERS - 4
SIDE A-6
VACUUM CLEANER

A-7
FOOD, PACKAGED
FECAL COLLECTION ASSY. - 30 (12*)
FECAL COLLECTION ASSY. BAGS - 2 (1*)

SIDE OF A-7
INFLT. RETAINER STRAP
EVA UMBILICAL & BAG

LM TRANSFER ITEMS

A-8
IN-FLIGHT EXERCISER
CWC - 9
EMU MAINTENANCE KIT
LIGHT WEIGHT HEADSETS - 3
CWC ELECTRICAL ADAPTERS - 4
CWC ELECTRICAL ADAPTERS BAG
RELIEF RECEPTACLE ASSY. W/STRAP
RELIEF RECEPT. CONTAINER
O₂ GAS FILTER ASSY. - 3
TOOL SET ASSEMBLY
P V DUCTS & BAG - 3

70MM FILM MAGAZINES AND BAG - 3
70 MM MAG. AND TRANS. BAG - 3*
H₂ GAS SEPARATOR
H₂ GAS SEPARATOR BAG
PCA O₂ UMBILICAL INTERCONN. - 3 (1*)
O₂ INTERCONNECT CONTAINER
SHAG LINE & BAG
ARCILLARY KIT*
HFLIGHT RETAINER STRAP
WATER PANEL COUPLING ASSY.
WMS WATER PANEL QB
WMS POWER CABLE
WMS QD PRESSURE CAP
WMS O/U CONTAINER
QD ECS CONTAINER
TAPE CASSETTE KIT
ACOUSTIC TONE BOOSTER & BAG
ALFMEID EYESHIELDS - 3
16MM FILM MAGS AND BAGS - 4
35 MM CAMERA ADAPTER - 8 BAG
URINE FILTER ASSY AND BAG - 3
TAPE RECORDER BATTERIES - 11
TAPE RECORDER BATTERIES BAG (PPK)
16MM CAMERA BRACKET & BAG
SIDE OF A-8
BAG - HOSE, URINE, VACUUM ETC.*
VACUUM BRUSH
URINE NOSE ASSY.
EVA GUARDS (LEFT, CENTER, RIGHT)
UTILITY STRAP
UNIPOD POLE

A-9
CO₂ ABSORBERS - 4
CARRIER ASSY. CONTAINER

B-1
FOOD AND HYGIENE ITEMS

B-2
35MM CAMERA AND MAG
35MM FILM CASS. - 3
35MM CAMERA GADGET BAG

B-3
70MM HASSELBLAD CAMERA AND MAG.
16MM CAMERA AND MAG.
75MM LENS
18MM LENS
10MM LENS WITH COVER
POWER CABLE, DAC
RIGHT ANGLE MIRROR
HFLIGHT RETAINER STRAP
P AUTO SPOTMETER

B-5
CO₂ ABSORBERS - 4
CLOSEOUT CURTAIN
DATA RETENTION STRAPS (SHORT) - 6
DATA RETENTION STRAPS (LONG) - 6
TEMP. STORAGE POUCHES - 2

B-6
CO₂ ABSORBERS - 4
CLOSEOUT CURTAIN
DATA RETENTION HOOKS (SHORT) - 2
DATA RETENTION HOOKS (LONG) - 2
SNAP CLAMPS - 8
SPRING CLIPS - 8

B-8
CHLOR. BUFFER AMPULES - 16
CHLOR. AMPULES - 16
CHLOR. AMPULES CONTAINERS - 2

L-2
CCU CONTROL HEAD CONTAINER
CCU CONTROL HEAD
GROUNDING CABLE
CCU CABLE (SPARE)
CCU CABLE STRAP
TOOL & HANDLE ADAPTER
HFLIGHT RETAINER STRAPS - 2
70MM INTERVAL METER CABLE (PCM)
16MM DAC TYPING CABLE (PCM)
DOCKING PROBE CABLE

L-3
FOOD, PACKAGED
CONTINGENCY FEEDING VALVE

R-1
CONTINGENCY CHECKLIST
ENTRY CHECKLIST
SYSTEMS CHECKLIST
SYSTEMS UPDATE
GAC CHECKLIST

R-2
LAUNCH CHECKLIST
CSM UPDATES
CSM/LM ORBIT MONITOR CHARTS

R-3
RESCUE BOOK
EARTH ORBITAL MAP
DATA CARD KIT
EYEPATCH
METER COVERS - 2
VERB-HOJNS, C AND H PANEL
FUSE (16MM CAMERA)
FLIGHT DATA FILE CLIPS - 6
LM XFR DATA CARD KIT *
LM DATA CARD BOOK
LM LUNAR SURFACE CHECKLIST
LM ACTIVATION CHECKLIST
LM TIMELINE BOOK
LM ORBIT CHARTS (A, B, C, D)

R-12
CSM LUNAR LADDMARK MAP
CSM SYSTEM DATA
CSM MALFUNCTION PROCEDURES
FLIGHT PLAN
CMP SOLD BOOK

R-4
RUCKSACK SURVIVAL KIT NO. 1
RUCKSACK SURVIVAL KIT NO. 2

R-5
PROBE STORAGE STRAPS - 2
HFLIGHT RETAINER STRAPS - 9 (4*)
UTILITY STRAPS - 6 (3*)

R-6
COUCH RESTRAINING STRAPS - 2

R-6
TAPE
OXA HIGH DENSITY SMIFILTERS - 2
CHLOR. SYRINGE KNOB
CHLOR. SYRINGE CASING
CHLOR. NEEDLE
CHLOR. SYRINGE CONTAINER
PERLIGHTS AND CONTAINER - 5

R-8
MEDICAL KIT

R-11
URINE TRANSFER SYSTEMS - 3
URINE RECEIVER ASSY. (SPARE)
ROLL ON CLIPS (RED, WHITE, BLUE)
URINE FILTER, HICAP, & BAG

R-13
16MM MAGAZINES AND TRANS. BAG - 6*
16 MM MAG. AND TRANS. BAG - 2*
70 MM MAGAZINES AND TRANS. BAG - 4*
70 MM MAG. AND TRANS. BAG - 3*
RADIATION DOSIMETER
70 MM MAG. AND TRANS. BAG - 3*
16 MM MAG. AND TRANS. BAG - 2*

AFT. BLEND.
EVA UMBILICAL ASSY.
EVA TETHER CONTAINER

U-1
LIQUID COOLED GARMENTS - 2*
TEMPORARY STOWAGE CONTAINERS - 3
H²O RADIATION DOSIMETER
U-2
HFLIGHT HELMET STORAGE BAGS - 3
ACCESS Y BAGS - 3
HCC JACKETS - 3
HCC TROUSERS - 3
HCC BOOTS (RIGHT) - 3
HCC BOOTS (LEFT) - 3
EARTUBES - 3
CABIN FAN FILTER AND BAG

U-3
COAS FILTER
COAS LIGHT BULB
16MM CAMERA BRACKET
LM DOCKING TARGET
DOCKING TARGET ADAPTER

U-4
TAPE RECORDER CASSETTES - 4
TAPE RECORDER BATTERIES - 4
10 X 40 MONOCULAR
INTERVALOMETER (70MM HASSELBLAD)
250MM LENS

PCA BAG
HELMET PROTECTIVE SHIELD
ELECTRICAL CONNECTOR COVERS - 3
UCTA CLAMPS - 3
WATER BAGS, CONTING. RETURN 1-5
P/O URINE BAGS, CONTINGENCY - 3
FECAL MANAGEMENT BAG*

PCA
O₂ NOSE SCREEN CAPS - 3
EAR PLUGS - 2 PR

ECU
CO₂ ABSORBERS - 2

LMFEB
CCU CABLE (LEFT, CENTER, RIGHT)
WATER CUP

LMLED
O₂ UMBILICAL CL., CENTER, R)
O₂ NOSE CLAMPS - 3
ASSY. L CALFAK ADAPTER

UEB
REHEZVIOUS SHADE (LEFT, RIGHT)
SIRE SHADE (L, C, R)
MATCH SHADE
WINDOW SHADE CONTAINER
RR REHEZVIOUS SHADE (S-178 EXP.)
UV WINDOW SHADE

AFT. BLEND.
SLEEP RESTRAINTS (L, CENTER, R)
O₂ MASK AND HOSE - 3
O₂ MASK AND HOSE CONTAINER
HFLIGHT RETAINER STRAPS - 3

3.1-53

SNA-8-D-027(III) REV 3

TABLE 3.1-9 (CONTINUED)
MISSION J-1 COMMAND MODULE STOWAGE VOLUME CENTROID

LAUNCH STOWAGE	ITEM	RETURN STOWAGE
LM	40 LB SAMPLE	Top of A-1
LM	PPK'S - 3	A-8
LM	CONTINGENCY LUNAR SAMPLE	On Top of A-2 in ISA
LM	OXYGEN PURGE SYSTEM	A-7
LM	EMU MAINTENANCE KIT	In CDR Helmet Stowage Bag in PGA Bag
LM	PURGE VALVE ASSY.	A-7
LM	STANDARD FLAG KIT	A-8
LM	CONTINGENCY IV SAFETY TETHER	A-7
LM	SR C NO. 1	B-5
LM	2	B-6
LM	SOLAR WIND COMPOSITION	On Top Of A-2 in ISA
LM	IV CREWMAN TETHERS - 2	A-7
LM	ISA	Inside ISA Decon. Bag on Top of A-2
LM	SAMPLE RETURN BAG (B/SLSS AREA - 36 lb)	Inside Sample Return Decon. Bag on Top of A-7
LM	PRENETROMETER DRUM	A-7
LM	40LB SAMPLE	A-9
LM	40LB SAMPLE	In PGA Bag
A-2	603 GAUGE ASSY	A-7
A-2	SAMPLE RETURN DECON. BAG (B/SLSS AREA)	ON TOP OF A-7
TOP A-2	PENETROMETER DECONT BAG	A-7
A-2	VACUUM CLEANER BAGS-2	A-7
A-2	VACUUM CLEANER POWER CABLE	A-7
A-2	VACUUM CLEANER DECOM. BAG	A-7
A-2	HEAD REST PADS - 3	On Couch
A-2	HEEL CLIPS - 3 PR.	On Crew
A-2	OFS CONTROL UNIT ADAPTER	A-7
A-2	GPS ATTACH. STRAPS - 4	A-7
A-2	EVA EQUIPMENT CONTAINER	A-7
A-7	FECAL COLLECTION ASSY. - 3D	12 - Offloaded Unused A-7
A-8	CWG ELECTRICAL ADAPTERS - 4	3 - On Crew 1 - A-8
SM SIM BAY	24" PAN CAMERA MAGAZINE	A-2
SM SIM BAY	3" MAPPING CAMERA MAGAZINE	B-1

LAUNCH STOWAGE	ITEM	RETURN STOWAGE
LM	ANCILLARY KIT	A-8
B-5	CONTAINERS	Offloaded TO LM
B-6	CONTAINERS	Offloaded TO LM
A-9	CO ₂ ABSORBERS - 4	A-9 Offloaded Inside Container
B-5	CO ₂ ABSORBERS - 4	B-5 Offloaded Inside Container
B-6	CO ₂ ABSORBERS - 4	B-6 Offloaded Inside Container
TOP A-2	SRC DECON. BAGS - 2	1 - B-5 1 - B-6
U-2	ICG JACKETS - 3	On Crew
U-2	ICG TROUSERS - 3	On Crew
U-2	ICG BOOTS (RIGHT) - 3	On Crew
U-2	ICG BOOTS (LEFT) - 3	On Crew
	<u>PGA EQUIPMENT</u>	
ON CREW	PRESSURE HELMETS - 3	2 - In PGA Bag 1 - On PGA, Sleep Restraint on Top A-7 and A-8
ON CREW	PRESSURE GARMENT ASSEMBLY (PGA) - 3	2 - In PGA Bag 1 - In Sleep Restraint on Top A-7 and A-8
LM	LEVA'S - 2	2 - On Helmet in PGA Bag
A-2	EV GLOVES (CMP)	In Helmet in Accessory Bag On Top of A-7 & A-8
LM	EV GLOVES - 2 PR.	In Helmet in Accessory Bags in PGA Bag
ON CREW	IV GLOVES - 3 PR.	2 - In PGA's in PGA Bag 1 - In PGA in Sleep Restraint on Top of A-7 and A-8
U-2	ACCESSORY BAGS - 3	2 - In Helmets In PGA Bag 1 - In Helmet on Top of A-7 and A-8
LM	HELMET STOWAGE BAGS - 2	2 - On Helmet in PGA Bag
PGA BAG	HELMET PROTECTIVE SHIELD	On Helmet (Without LEVA) Top of A-7 and A-8

NOTE: THIS STOWAGE LOCATION CHART ONLY DEPICTS THE STOWAGE OF EQUIPMENT THAT IS DIFFERENT FROM LAUNCH TO RETURN.

3.1-54

SNA-8-D-027(III) REV 3

TABLE 3.1-9 (CONTINUED)
MISSION J-1 COMMAND MODULE STOWAGE VOLUME CENTROIDS

SPACECRAFT 112

<u>AREA</u>	<u>X</u>	<u>Y</u>	<u>Z</u>
A1	1011.0	-21.0	-22.0
2	1011.0	-22.0	8.0
A2 ISA	1019.0	-22.0	8.0
3	1016.0	-24.0	28.0
4	1015.0	-7.0	28.0
5	1015.0	9.0	28.0
6	1017.0	26.0	28.0
7	1011.0	22.0	8.0
8	1011.0	21.0	-23.0
9	1013.0	0.0	16.0
Top of A1	1017.0	-21.0	-22.0
Top of A2	1019.0	-22.0	8.0
Top of A7	1019.0	22.0	8.0
Top of A8	1020.0	25.0	-8.0
Top of A9	1016.0	0.0	16.0
Between PGA & A9	1014.0	0.0	8.0
B1	1050.0	-27.0	39.0
2	1039.0	-38.0	37.0
3	1031.0	-28.0	40.0
4	1031.0	-20.0	40.0
5	1031.0	-8.0	39.0
6	1031.0	13.0	39.0
8	1024.0	-38.0	37.0
L2	1059.0	-44.0	14.0
3	1048.0	-47.0	12.0
R1	1072.0	26.0	21.0
2	1072.0	26.0	14.0
3	1072.0	26.0	9.0
4	1075.0	28.0	3.0
5	1059.0	44.0	15.0
6	1048.0	46.0	29.0
8	1052.0	46.0	12.0
11	1038.0	47.0	26.0
13	1024.0	45.0	-26.0
U1	1033.0	23.0	-50.0
2	1033.0	-23.0	-50.0
3	1033.0	-36.0	-44.0
4	1038.0	39.0	-43.0
L. H. Crew Station	1043.0	-24.5	-11.9
Ctr. Crew Station	1043.0	0.0	-11.9
R. H. Crew Station	1043.0	24.5	-11.9



TABLE 3.1-9 (CONCLUDED)

MISSION J-1 COMMAND MODULE STOWAGE VOLUME CENTROID

The following stowage locations have unique volume centroids not associated with stowage volumes.

<u>NOMENCLATURE</u>	<u>LOCATION</u>	<u>X</u>	<u>Y</u>	<u>Z</u>
G&N Signal Cond. Panel	LEB	1069.0	25.0	29.0
Display Keyboard	LEB	1060.0	26.0	32.0
Sleep Restraint Assy - Rt. & Center	Aft UEB	1018.0	23.0	-50.0
Sleep Restraint Assy - Left	Aft UEB	1018.0	-23.0	-50.0
Entry Locations				
Sleep Restraint - RH & Center	Top of Area A8	1020.0	25.0	-8.0
ITLSA - IV (CMP)	On RH & Ctr.			
	Sleep Restraint	1020.0	25.0	-22.0
Food Container	L3	1048.0	-47.0	12.0
Food Container	B1	1050.0	-27.0	39.0
Food Container	A7	1011.0	22.0	8.0
Fecal Stowage Container	RHEB	1039.0	47.0	12.0
PGA Container	On Aft Bulkhead	1015.0	0.0	-20.0
	Under Ctr. Couch			
Entry Location	Aft Bulkhead	1015.0	0.0	-6.0
Forward Hatch Container	Under LH Couch	1018.0	-24.5	-15.0
Container, R12				
(In-flight Location)	RH Girth Ring	1034.0	41.0	-21.0
Helmet Stowage & Accessory				
Bags (In-flight Location) - LH	U2	1033.0	-23.0	-50.0
Helmet Stowage and Accessory				
Bags (In-flight Location) - Ctr.	B1	1050.0	-27.0	39.0
Helmet Stowage and Accessory				
Bag (In-flight Location) - RH	L3	1048.0	-47.0	12.0
CO2 Absorbers (2)	In ECU	1031.0	-48.3	19.6
CO2 Absorbers (4)	A3	1016.0	-24.0	28.0
CO2 Absorbers (4)	A4	1015.0	-7.0	28.0
CO2 Absorbers (4)	A5	1015.0	9.0	28.0
CO2 Absorbers (4)	A6	1017.0	26.0	28.0
CO2 Absorbers (4)	A9	1013.0	0.0	16.0
CO2 Absorbers (4)	B5	1031.0	-8.0	39.0
CO2 Absorbers (4)	B6	1031.0	13.0	39.0
	Order of Locations Used in Sequential Mass Properties Tables for CO2 Absorbed			
First 8.0 lb CO2 Absorbed	B5	1031.0	-8.0	39.0
Second 16.0 lb CO2 Absorbed	(B6, A9)	1022.0	6.5	27.5
Remainder CO2 Absorbed	Composite Location	1017.4	-4.4	27.1



TABLE 3.1-9.1

MISSION J-1 LUNAR MODULE STOWAGE VOLUME CENTROIDS

LM-10

<u>AREA</u>	<u>DESCRIPTION</u>	<u>X</u>	<u>Y</u>	<u>Z</u>
A1A	Flight Data File	280.0	-19.0	13.5
A1B	PLSS-Recharge Stat	263.5	-20.6	14.9
A1C	ICG, Elect. Harness	240.5	-15.3	13.3
A1D	In-Flight ISA	270.3	-15.0	19.0
A1E	OPS-Upper	265.9	-20.7	-6.0
A1F	OPS-Lower	257.4	-20.7	-6.0
A1G	Jett Bag (4) & CLSRC	257.5	-20.0	-18.0
A1H	PPK & Standard Flag	265.9	-20.0	-18.0
A1J	LM Medical Pkg	273.7	-20.4	1.2
A1L	Boots & Purge Vlv-Upper	281.0	-20.0	-8.5
A1K	Boots & Purge Vlv-Lower	273.7	-20.0	-8.5
A1DA				
A1DB				
A1DC	In-Flight ISA Items	270.3	-15.0	19.0
A1DD				
A2	DSEA	260.0	-37.0	28.0
A3	ISA-Aft Eng. Cover	280.0	0.0	-10.0
A5	BSLSS, ETB, PLSS Tool Carrier	221.8	-1.0	29.5
A6	Water Disp/Fire Ext.	278.5	-11.0	23.0
A7	ECS Umbilicals	250.0	11.5	31.0
A8	Bungee Cord	272.6	14.8	17.3
A9	LM Food Assy	288.0	0.0	-24.0
A10	ECS LiOH Can.-Eng. Cover	250.0	8.0	-11.8
A11	ECS LiOH, PLSS LiOH-190 Mod.	262.4	19.8	4.2
A12	RCU (2)	272.0	0.0	-18.0
A13	Docking Drogue	300.0	0.0	0.0
A14	500 MM Lens/70 MM Cam Assy	239.6	-5.5	-14.8
A15	Bungee Cord	257.0	-30.0	27.5
F1A	Fecial Wet Wipes	244.5	-36.6	31.4
F1B	Lightweight Headset	235.5	-35.5	38.5
F1C	Urine Recpt.	242.5	-35.5	38.6
F1D	Tape & Utility Towel Check	242.8	-35.4	44.7
F1E	CWG Elect. Harn. & Tiss. Disp.	237.9	-33.6	55.0
F1F	Emesis, Urine Coll., Defec.	235.5	-37.6	46.6
F1G	Hammocks & Towels	228.0	-40.2	43.2
F1H	COAS Bulb & Filter	229.5	-35.5	39.0
F1J	UCTA Clamp	229.5	-35.5	35.0
F1K	Empty	237.8	-37.8	31.5
F2	Drogue-Abandon LM	218.5	-22.0	43.4
F3	COAS-Manned Pos.	292.0	-21.0	38.6

TABLE 3.1-9.1 (CONCLUDED)

MISSION J-1 LUNAR MODULE STOWAGE VOLUME CENTROIDS

LM-10

<u>AREA</u>	<u>DESCRIPTION</u>	<u>X</u>	<u>Y</u>	<u>Z</u>
F4	COAS Earth Launch	282.2	-21.0	66.6
F5	16 MM Camera-DAC	286.0	17.8	66.6
F6A,B,C	ISA-Earth Launch	270.3	0.0	52.8
F7A	16 MM Camera Wedge Brkt	238.0	38.0	49.8
F7B	Monocular	238.4	38.6	46.0
F7C	70 MM Camera Assy	242.8	38.0	41.0
F7D	70 MM Film Magazines (4)	238.0	38.0	38.4
F7E	Neck Ring & LGC Adapters	243.2	38.0	31.2
F7F	Camera Mount Brkt & Wrench	238.0	38.0	31.6
F7G	AOT Eyeguard & Filter	227.9	33.0	31.8
F7H	16 MM Cam Fuse Assy w/Bag	237.7	38.3	45.5
F7J	Cont. Tiedn Webbing, Etc.	231.5	35.4	41.8
F7K	Sample Scale	222.6	32.3	42.7
F7L	16 MM Film Magazines	231.8	36.0	47.3
F7M	Empty	225.7	32.3	53.4
F7N	LEC-Waist Tether Kit	238.0	38.0	53.1
F7P	70 MM Film Mags (3)	241.0	38.0	53.4
F8	LMP Helmet Bag	221.0	18.0	51.0
F9	PLSS-Floor	219.9	-1.3	44.5
F10	CDR Helmet Bag	221.0	-18.0	51.0



TABLE 3.1-9.2
MISSION J-1 TRANSFERABLE EQUIPMENT

Amendment 110
7/19/71

REFERENCE CODE EXPLANATION

The reference table used with this Transferable Equipment List is a directory of information sources from which data for each item were obtained. It is intended to define the exact source for each portion of the data used. This reference table is correlated to each item in the Transferable Equipment List by a 3-digit reference code number.

The code is the form

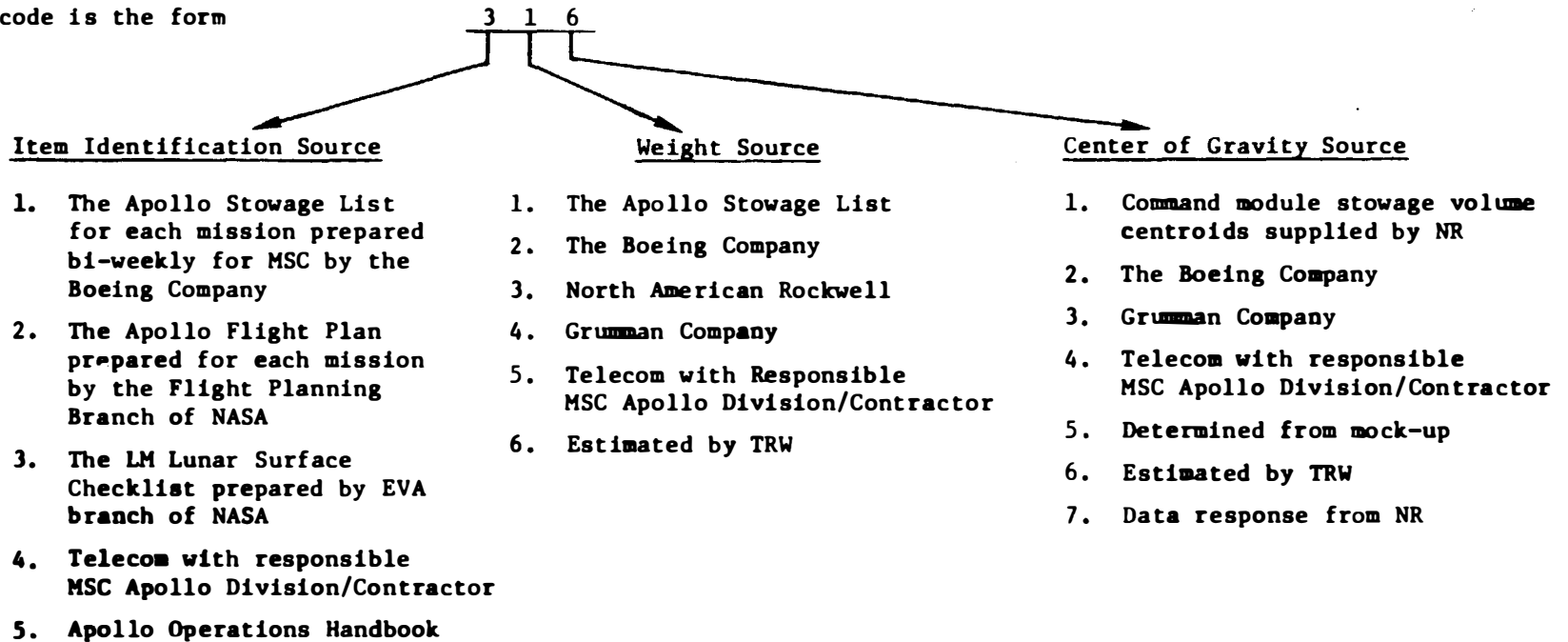

3.1-59

SNA-8-D-027(III) REV 3

7/19/71

TABLE 3.1-9.2 (CONTINUED)

MISSION J-1 TRANSFERRED CREW AND EQUIPMENT STOWAGE LIST								
ITEMS REARRANGED IN CM PRIOR TO FIRST MID-COURSE CORRECTION (1)								
						APOLLO COORDINATES		
DESCRIPTION	STOW. ITEM	REF	NO.	STOWAGE LOCATION	WEIGHT	X-C.G.	Y-C.G.	Z-C.G.
CREW-COMMAND MODULE PILOT (CMP)	N/A	227	1	ON COUCH(CTR CRW,STA	159.5	1043.0	.0	-10.4
CREW-COMMANDER (COR)	N/A	227	1	ON COUCH(LH CREW STA	183.5	1043.0	-24.5	-10.4
BAG, MOTION SICKNESS	A0208.	111	1	ON CREW	.1	1043.0	.0	-21.0
BAG, MOTION SICKNESS	A0208.	111	1	ON CREW	.1	1043.0	.0	-21.0
BAG, MOTION SICKNESS	A0208.	111	1	ON CREW	.1	1043.0	.0	-21.0
JACKET ASSY, ICG	B0112.1	111	1	AREA U2	1.8	1033.0	-23.0	-50.0
JACKET ASSY, ICG	B0112.1	111	1	AREA U2	1.8	1033.0	-23.0	-50.0
JACKET ASSY, ICG	B0112.1	111	1	AREA U2	1.8	1033.0	-23.0	-50.0
TROUSER ASSY, ICG	B0112.2	111	1	AREA U2	1.8	1033.0	-23.0	-50.0
TROUSER ASSY, ICG	B0112.2	111	1	AREA U2	1.8	1033.0	-23.0	-50.0
TROUSER ASSY, ICG	B0112.2	111	1	AREA U2	1.8	1033.0	-23.0	-50.0
BOOT, RIGHT, ICG	B0112.3	111	1	AREA U2	.4	1033.0	-23.0	-50.0
BOOT, RIGHT, ICG	B0112.3	111	1	AREA U2	.4	1033.0	-23.0	-50.0
BOOT, RIGHT, ICG	B0112.3	111	1	AREA U2	.4	1033.0	-23.0	-50.0
BOOT, LEFT, ICG	B0112.4	111	1	AREA U2	.4	1033.0	-23.0	-50.0
BOOT, LEFT, ICG	B0112.4	111	1	AREA U2	.4	1033.0	-23.0	-50.0
BOOT, LEFT, ICG	B0112.4	111	1	AREA U2	.4	1033.0	-23.0	-50.0
HARNESS, CWG ELECTRICAL (CMP)	B0135.	111	1	IN ADAPTER BAG (A8)	.4	1011.0	21.0	-23.0
HARNESS, CWG ELECTRICAL (COR)	B0135.	111	1	IN ADAPTER BAG (A8)	.4	1011.0	21.0	-23.0
HARNESS, CWG ELECTRICAL (LMP)	B0135.	111	1	IN ADAPTER BAG (A8)	.4	1011.0	21.0	-23.0
PGA ADAPTER	B0151.	111	1	AREA A2	1.0	1011.0	-22.0	8.0
HARNESS, OPS-UPPER R.H.	B0156.	111	1	AREA A2	.1	1011.0	-22.0	8.0
HARNESS, OPS-UPPER L.H.	B0157.	111	1	AREA A2	.1	1011.0	-22.0	8.0
TETHER, WRIST	B0154.	111	1	AREA A2	.3	1011.0	-22.0	8.0
VEST, OVAL LIFE	B0202.	111	1	ON CREW	2.4	1047.2	.0	-23.4
VEST, OVAL LIFE	B0202.	111	1	ON CREW	2.4	1047.2	.0	-23.4
VEST, OVAL LIFE	B0202.	111	1	ON CREW	2.4	1047.2	.0	-23.4
UCTA	B0205.	111	1	ON CREW	.5	1043.0	.0	-5.9
UCTA	B0205.	111	1	ON CREW	.5	1043.0	.0	-5.9
UCTA	B0223.	111	1	ON CREW	.5	1043.0	.0	-5.9
ITLSA - EV	B0211.	111		ON CREW COR LH STA	46.9	1043.0	-24.5	-11.9
ITLSA - EV	B0211.	111		ON CREW RH STA	46.9	1043.0	24.5	-11.9

3.1-60

SNA-8-D-027(III) REV 3

TABLE 3.1-9.2 (CONTINUED)

MISSION J-1 TRANSFERRED CREW AND EQUIPMENT STOWAGE LIST								
ITEMS REARRANGED IN CM PRIOR TO FIRST MID-COURSE CORRECTION (1)							APOLLO COORDINATES	
DESCRIPTION	STOW. ITEM	REF	NO.	STOWAGE LOCATION	WEIGHT	X-C.G.	Y-C.G.	Z-C.G.
ITLSA - EV	80212.	111		ON CREW CMP CTR STA	41.8	1043.0	.0	-11.9
GLOVES, IV PAIR	80213.	111	1	ON CREW CMP CTR STA	2.0	1043.0	.0	-11.9
GLOVES, IV PAIR	80213.	111	1	ON CREW COR LH STA	2.0	1043.0	-24.5	-11.9
GLOVES, IV PAIR	80213.	111	1	ON CREW RH STA	2.0	1043.0	24.5	-11.9
HELMET ASSY, PRESSURE	80214.	111	1	ON CREW CMP CTR STA	2.6	1043.0	.0	-11.9
HELMET ASSY, PRESSURE	80214.	111	1	ON CREW CDR LH STA	2.6	1043.0	-24.5	-11.9
HELMET ASSY, PRESSURE	80214.	111	1	ON CREW RH STA	2.6	1043.0	24.5	-11.9
HARNESS, ELEC - SUIT	80224.	111	1	ON CREW CDR LH STA	.5	1043.0	-24.5	-11.9
HARNESS, ELEC - SUIT	80224.	111	1	ON CREW CMP CTR STA	.5	1043.0	.0	-11.9
HARNESS, BIOINSTRUMENTATION	80216.	111	1	ON CREW CDR LH STA	.3	1043.0	-24.5	-11.9
HARNESS, BIOINSTRUMENTATION	80216.	111	1	ON CREW CMP CTR STA	.3	1043.0	.0	-11.9
COMMUNICATION CARRIER	80217.	111	1	ON CREW RH STA	1.6	1043.0	24.5	-11.9
COMMUNICATION CARRIER	80217.	111	1	ON CREW COR LH STA	1.6	1043.0	-24.5	-11.9
COMMUNICATION CARRIER	80217.	111	1	ON CREW CMP CTR STA	1.6	1043.0	.0	-11.9
POCKET, SCISSORS (CMP)	80218.	111	1	ON CREW CMP CTR STA	.2	1043.0	.0	-11.9
POCKET, SCISSORS (COR)	80218.	111	1	ON CREW CDR LH STA	.2	1043.0	-24.5	-11.9
POCKET, SCISSORS (LMP)	80218.	111	1	ON CREW RH STA	.2	1043.0	24.5	-11.9
POCKET, CHECKLIST (CDR)	80219.	111	1	ON CREW CDR LH STA	.2	1043.0	-24.5	-11.9
POCKET, CHECKLIST (LMP)	80219.	111	1	ON CREW RH STA	.2	1043.0	24.5	-11.9
POCKET, DATA (CDR)	80220.	111	1	ON CREW CDR LH STA	.2	1043.0	-24.5	-11.9
POCKET, DATA (LMP)	80220.	111	1	ON CREW RH STA	.2	1043.0	24.5	-11.9
POCKET, CHECKLIST (CMP)	80221.	111	1	ON CREW CMP CTR STA	.2	1043.0	.0	-11.9
POCKET, DATA (CMP)	80222.	111	1	ON CREW CMP CTR STA	.2	1043.0	.0	-11.9
DOSIMETER, PASSIVE	80201.	117	3	CWG POCKET (STOWED)	NEGL	1015.0	.0	-19.0
DOSIMETER, PASSIVE	80201.	117	3	CWG POCKET (STOWED)	NEGL	1015.0	.0	-19.0
HEADSET, LIGHTWEIGHT	E0111.	111	1	AREA A8	.4	1011.0	21.0	-23.0
HEADSET, LIGHTWEIGHT	E0112.	111	1	AREA A8	.4	1011.0	21.0	-23.0
HEADSET, LIGHTWEIGHT	E0113.	111	1	AREA A8	.4	1011.0	21.0	-23.0
EARTUBE, UNIVERSAL (CMP)	E0114.	111	1	AREA U2	NEGL	1033.0	-23.0	-80.0
EARTUBE, UNIVERSAL (CDR)	E0115.	111	1	AREA U2	NEGL	1033.0	-23.0	-80.0
EARTUBE, UNIVERSAL (LMP)	E0116.	111	1	AREA U2	NEGL	1033.0	-23.0	-80.0
EARPIECE, MOULDED (COMM. CARRIER)	E0200.1	111	1	ON CREW	NEGL	1080.0	.0	-24.0

3.1-61

SMA-8-D-027(III) REV 3

TABLE 3.1-9.2 (CONTINUED)

MISSION J-1 TRANSFERRED CREW AND EQUIPMENT STOWAGE LIST								
ITEMS REARRANGED IN CM PRIOR TO FIRST MID-COURSE CORRECTION (1)								
APOLLO COORDINATES								
DESCRIPTION	STOW. ITEM	REF	NO.	STOWAGE LOCATION	WEIGHT	X-C.G.	Y-C.G.	Z-C.G.
EARPIECE, MOULDED (COMM. CARRIER)	E0200.1	111	1	ON CREW	NEGL	1050.0	.0	-29.0
EARPIECE, MOULDED (COMM. CARRIER)	E0200.1	111	1	ON CREW	NEGL	1050.0	.0	-29.0
EARTUBE (COMM. CARRIER)	E0200.2	111	2	ON CREW	NEGL	1050.0	.0	-29.0
EARTUBE (COMM. CARRIER)	E0200.2	111	2	ON CREW	NEGL	1050.0	.0	-29.0
EARTUBE (COMM. CARRIER)	E0200.2	111	2	ON CREW	NEGL	1050.0	.0	-29.0
CONTAINER, R12	00344.	115	1	AREA R3	2.7	1072.0	26.0	9.0
CONTAINER, EVA EQUIPMENT	06358.	111	1	AREA A2	2.0	1011.0	-22.0	8.0
HARNESS, OPS-LOWER R.H.	R0158.	111	1	AREA A2	.1	1011.0	-22.0	8.0
HARNESS, OPS-LOWER L.H.	R0159.	111	1	AREA A2	.1	1011.0	-22.0	8.0
CM EQUIP. RELOC. 1					531.61	1042.59	-8.99	-11.83

3.1-62

TABLE 3.1-9.2 (CONTINUED)

MISSION J-1 TRANSFERRED CREW AND EQUIPMENT STOWAGE LIST								
ITEMS REARRANGED IN CM PRIOR TO FIRST MID-COURSE CORRECTION (2)								
						APOLLO COORDINATES		
DESCRIPTION	STOW. ITEM	REF	NO.	STOWAGE LOCATION	WEIGHT	X-C.G.	Y-C.G.	Z-C.G.
CREW-COMMAND MODULE PILOT (CMP)	N/A	227	1	ON COUCH(LH CREW STA	159.5	1043.0	-24.5	-10.4
CREW-COMMANDER (CDR)	N/A	227	1	ON COUCH(CTR CRW STA	183.5	1043.0	.0	-10.4
BAG, MOTION SICKNESS	A0208.	111	1	ON PGA (PGA CONT)	.1	1011.0	.0	-14.0
BAG, MOTION SICKNESS	A0208.	111	1	ON PGA (PGA CONT)	.1	1011.0	.0	-14.0
BAG, MOTION SICKNESS	A0208.	111	1	ON PGA (PGA CONT)	.1	1011.0	.0	-14.0
JACKET ASSY, ICG	B0112.1	111	1	ON CREW LH STA	1.8	1043.0	-24.5	-11.9
JACKET ASSY, ICG	B0112.1	111	1	ON CREW CTR STA	1.8	1043.0	.0	-11.9
JACKET ASSY, ICG	B0112.1	111	1	ON CREW RH STA	1.8	1043.0	24.5	-11.9
TROUSER ASSY, ICG	B0112.2	111	1	ON CREW LH STA	1.8	1043.0	-24.5	-11.9
TROUSER ASSY, ICG	B0112.2	111	1	ON CREW CTR STA	1.8	1043.0	.0	-11.9
TROUSER ASSY, ICG	B0112.2	111	1	ON CREW RH STA	1.8	1043.0	24.5	-11.9
BOOT, RIGHT, ICG	B0112.3	111	1	ON CREW LH STA	.4	1043.0	-24.5	-11.9
BOOT, RIGHT, ICG	B0112.3	111	1	ON CREW CTR STA	.4	1043.0	.0	-11.9
BOOT, RIGHT, ICG	B0112.3	111	1	ON CREW RH STA	.4	1043.0	24.5	-11.9
BOOT, LEFT, ICG	B0112.4	111	1	ON CREW LH STA	.4	1043.0	-24.5	-11.9
BOOT, LEFT, ICG	B0112.4	111	1	ON CREW CTR STA	.4	1043.0	.0	-11.9
BOOT, LEFT, ICG	B0112.4	111	1	ON CREW RH STA	.4	1043.0	24.5	-11.9
HARNESS, CWG ELECTRICAL (CMP)	B0135.	111	1	ON CREW LH STA	.4	1043.0	-24.5	-11.9
HARNESS, CWG ELECTRICAL (CDR)	B0135.	111	1	ON CREW CTR STA	.4	1043.0	.0	-11.9
HARNESS, CWG ELECTRICAL (LMP)	B0135.	111	1	ON CREW RH STA	.4	1043.0	24.5	-11.9
PGA ADAPTER	B0151.	111	1	AREA A7	1.0	1011.0	22.0	8.0
HARNESS, OPS-UPPER R.H.	B0156.	111	1	AREA A7	.1	1011.0	22.0	8.0
HARNESS, OPS-UPPER L.H.	B0157.	111	1	AREA A7	.1	1011.0	22.0	8.0
TETHER, WRIST	B0154.	111	1	AREA A7	.3	1011.0	22.0	8.0
VEST, DUAL LIFE	B0202.	111	1	IN HSB (U2)	2.4	1033.0	-23.0	-50.0
VEST, DUAL LIFE	B0202.	111	1	IN HSB (U2)	2.4	1033.0	-23.0	-50.0
VEST, DUAL LIFE	B0202.	111	1	IN HSB (U2)	2.4	1033.0	-23.0	-50.0
UCTA	B0205.	111	1	IN CM PGA CONTAINER	.5	1015.0	.0	-20.0
UCTA	B0205.	111	1	IN CM PGA CONTAINER	.5	1015.0	.0	-20.0
UCTA	B0223.	111	1	IN CM PGA CONTAINER	.5	1015.0	.0	-20.0
ITLSA - EV	B0211.	111	1	ITLSA IN PGA CONT.	46.9	1011.0	.0	-20.0
ITLSA - EV	B0211.	111	1	ITLSA IN PGA CONT.	46.9	1011.0	.0	-20.0

3.1-63

SNA-8-D-027(III) REV 3

TABLE 3.1-9.2 (CONTINUED)

MISSION J-1 TRANSFERRED CREW AND EQUIPMENT STOWAGE LIST									
ITEMS REARRANGED IN CH PRIOR TO FIRST MID-COURSE CORRECTION (2)									
							APOLLO COORDINATES		
DESCRIPTION	STOW. ITEM	REF	NO.	STOWAGE LOCATION	WEIGHT	X-C.G.	Y-C.G.	Z-C.G.	
ITLSA - EV	B0212.	111		ITLSA IN PGA CONT.	41.8	1011.0	.0	-20.0	
GLOVES,IV PAIR	B0213.	111	1	IN HSB (U2)	2.0	1033.0	-23.0	-50.0	
GLOVES,IV PAIR	B0213.	111	1	IN HSB (U2)	2.0	1033.0	-23.0	-50.0	
GLOVES,IV PAIR	B0213.	111	1	IN HSB (U2)	2.0	1033.0	-23.0	-50.0	
HELMET ASSY, PRESSURE	R0214.	111	1	IN HSB (U2)	2.6	1033.0	-23.0	-50.0	
HELMET ASSY, PRESSURE	R0214.	111	1	HELMET STOW BAG (B1)	2.6	1050.0	-27.0	39.0	
HELMET ASSY, PRESSURE	B0214.	111	1	HELMET STOW.BAG (L3)	2.6	1048.0	-47.0	12.0	
HARNESS,ELEC - SUIT	R0224.	111	1	ON CREW CTR STA	.5	1043.0	.0	-11.9	
HARNESS,ELEC - SUIT	R0224.	111	1	ON CREW LH STA	.5	1043.0	-24.5	-11.9	
HARNESS, BIOINSTRUMENTATION	B0216.	111	1	ON CREW CTR STA	.3	1043.0	.0	-11.9	
HARNESS, BIOINSTRUMENTATION	B0216.	111	1	ON CREW LH STA	.3	1043.0	-24.5	-11.9	
COMMUNICATION CARRIER	B0217.	111	1	IN HSB (U2)	1.6	1033.0	-23.0	-50.0	
COMMUNICATION CARRIER	B0217.	111	1	HELMET STOW BAG (B1)	1.6	1050.0	-27.0	39.0	
COMMUNICATION CARRIER	B0217.	111	1	HELMET STOW.BAG (L3)	1.6	1048.0	-47.0	12.0	
POCKET,SCISSORS (CMP)	B0218.	111	1	ON ICG LH STA	.2	1043.0	-24.5	-11.9	
POCKET,SCISSORS (COR)	B0218.	111	1	ON ICG CTR STA	.2	1043.0	.0	-11.9	
POCKET,SCISSORS (LMP)	B0218.	111	1	ON ICG RH STA	.2	1043.0	24.5	-11.9	
POCKET,CHECKLIST (CDR)	B0219.	111	1	ON ICG CTR STA	.2	1043.0	.0	-11.9	
POCKET,CHECKLIST (LMP)	R0219.	111	1	ON ICG RH STA	.2	1043.0	24.5	-11.9	
POCKET,DATA(CDR)	B0220.	111	1	ON ICG CTR STA	.2	1043.0	.0	-11.9	
POCKET,DATA(LMP)	B0220.	111	1	ON ICG RH STA	.2	1043.0	24.5	-11.9	
POCKET,CHECKLIST (CMP)	B0221.	111	1	ON ICG LH STA	.2	1043.0	-24.5	-11.9	
POCKET,DATA(CMP)	B0222.	111	1	ON ICG LH STA	.2	1043.0	-24.5	-11.9	
DOSIMETER, PASSIVE	O0201.	117	3	CWG POCKETS	NEGL	1041.0	.0	-11.9	
DOSIMETER, PASSIVE	O0201.	117	3	CWG POCKETS	NEGL	1041.0	.0	-11.9	
HEADSET,LIGHTWEIGHT	E0111.	111	1	ON CREW LH STA	.4	1043.0	-24.5	-11.9	
HEADSET,LIGHTWEIGHT	E0112.	111	1	ON CREW CTR STA	.4	1043.0	.0	-11.9	
HEADSET,LIGHTWEIGHT	E0113.	111	1	ON CREW RH STA	.4	1043.0	24.5	-11.9	
EARTUBE,UNIVERSAL (CMP)	E0114.	111	1	ON ICG LH STA	NEGL	1043.0	-24.5	-11.9	
EARTUBE,UNIVERSAL (CDR)	E0115.	111	1	ON ICG CTR STA	NEGL	1043.0	.0	-11.9	
EARTUBE,UNIVERSAL (LMP)	E0116.	111	1	ON ICG RH STA	NEGL	1043.0	24.5	-11.9	
EARPIECE,MOULDED(COMM.CARRIER)	E0200.1	111	1	IN HSB (U2)	NEGL	1033.0	-23.0	-50.0	

3.1-64

SNA-8-D-027(III) REV 3

Amendment 110
7/19/71

TABLE 3.1-9.2 (CONTINUED)

MISSION J-1 TRANSFERRED CREW AND EQUIPMENT STOWAGE LIST								
ITEMS REARRANGED IN CM PRIOR TO FIRST MID-COURSE CORRECTION (2)							APOLLO COORDINATES	
DESCRIPTION	STOW. ITEM	REF	NO.	STOWAGE LOCATION	WEIGHT	X-C.G.	Y-C.G.	Z-C.G.
EARPIECE, MOULDED (COMM. CARRIER)	E0200.1	111	1	IN HSB (U2)	NEGL	1033.0	-23.0	-50.0
EARPIECE, MOULDED (COMM. CARRIER)	E0200.1	111	1	IN HSB (U2)	NEGL	1033.0	-23.0	-50.0
EARTUBE (COMM. CARRIER)	E0200.2	111	2	IN HSB (U2)	NEGL	1033.0	-23.0	-50.0
EARTUBE (COMM. CARRIER)	E0200.2	111	2	HELMET STOW BAG (B1)	NEGL	1050.0	-27.0	39.0
EARTUBE (COMM. CARRIER)	E0200.2	111	2	IN HSB (U2)	NEGL	1033.0	-23.0	-50.0
CONTAINER, R12	00344.	115	1	RH GIRTH RING	2.7	1034.0	41.0	-21.0
CONTAINER, EVA EQUIPMENT	0635A.	111	1	AREA A7	2.0	1011.0	22.0	8.0
HARNESS, OPS-LOWER R.H.	B0158.	111	1	AREA A7	.1	1011.0	22.0	8.0
HARNESS, OPS-LOWER L.H.	B0159.	111	1	AREA A7	.1	1011.0	22.0	8.0
CM EQUIP. RELOC. 1					531.61	1034.24	-8.36	-13.59

3.1-65

SNA-8-D-027 (III) REV 3

TABLE 3.1-9.2 (CONTINUED)

MISSION J-1 TRANSFERRED CREW AND EQUIPMENT STORAGE LIST								
ITEMS REARRANGED IN CM PRIOR TO LM ACTIVATION (3)								
APOLLO COORDINATES								
DESCRIPTION	STOW. ITEM	REF	NO.	STOWAGE LOCATION	WEIGHT	X-C.G.	Y-C.G.	Z-C.G.
BAG, MOTION SICKNESS	A0208.	111	1	ON PGA (PGA CONT)	.1	1011.0	.0	-14.0
BAG, MOTION SICKNESS	A0208.	111	1	ON PGA (PGA CONT)	.1	1011.0	.0	-14.0
BAG, MOTION SICKNESS	A0208.	111	1	ON PGA (PGA CONT)	.1	1011.0	.0	-14.0
JACKET ASSY, ICG	B0112.1	111	1	ON CREW LH STA	1.8	1043.0	-24.5	-11.9
JACKET ASSY, ICG	B0112.1	111	1	ON CREW CTR STA	1.8	1043.0	.0	-11.9
JACKET ASSY, ICG	B0112.1	111	1	ON CREW RH STA	1.8	1043.0	24.5	-11.9
TROUSER ASSY, ICG	B0112.2	111	1	ON CREW LH STA	1.8	1043.0	-24.5	-11.9
TROUSER ASSY, ICG	B0112.2	111	1	ON CREW CTR STA	1.8	1043.0	.0	-11.9
TROUSER ASSY, ICG	B0112.2	111	1	ON CREW RH STA	1.8	1043.0	24.5	-11.9
BOOT, RIGHT, ICG	B0112.3	111	1	ON CREW LH STA	.4	1043.0	-24.5	-11.9
BOOT, RIGHT, ICG	B0112.3	111	1	ON CREW CTR STA	.4	1043.0	.0	-11.9
BOOT, RIGHT, ICG	B0112.3	111	1	ON CREW RH STA	.4	1043.0	24.5	-11.9
BOOT, LEFT, ICG	B0112.4	111	1	ON CREW LH STA	.4	1043.0	-24.5	-11.9
BOOT, LEFT, ICG	B0112.4	111	1	ON CREW CTR STA	.4	1043.0	.0	-11.9
BOOT, LEFT, ICG	B0112.4	111	1	ON CREW RH STA	.4	1043.0	24.5	-11.9
SUBSYSTEM, FECAL CONTAINMENT	B0113.	111	01	AREA A2	.3	1011.0	-22.0	8.0
SUBSYSTEM, FECAL CONTAINMENT	B0113.	111	01	AREA A2	.3	1011.0	-22.0	8.0
SUBSYSTEM, FECAL CONTAINMENT	B0113.	111	1	AREA A2	.3	1011.0	-22.0	8.0
HARNESS, CWG ELECTRICAL (CMP)	B0135.	111	1	ON CREW LH STA	.4	1043.0	-24.5	-11.9
HARNESS, CWG ELECTRICAL (COR)	B0135.	111	1	ON CREW CTR STA	.4	1043.0	.0	-11.9
HARNESS, CWG ELECTRICAL (LMP)	B0135.	111	1	ON CREW RH STA	.4	1043.0	24.5	-11.9
UCTA	B0205.	111	1	IN CM PGA CONTAINER	.5	1015.0	.0	-20.0
UCTA	B0205.	111	1	IN CM PGA CONTAINER	.5	1015.0	.0	-20.0
UCTA	B0223.	111	1	IN CM PGA CONTAINER	.5	1015.0	.0	-20.0
ITLSA - EV	B0211.	111		ITLSA IN PGA CONT.	46.9	1011.0	.0	-20.0
ITLSA - EV	B0211.	111		ITLSA IN PGA CONT.	46.9	1011.0	.0	-20.0
ITLSA - EV	B0212.	111		ITLSA IN PGA CONT.	41.8	1011.0	.0	-20.0
GLOVES, IV PAIR	B0213.	111	1	IN HSB (U2)	2.0	1033.0	-23.0	-50.0
GLOVES, IV PAIR	B0213.	111	1	IN HSB (U2)	2.0	1033.0	-23.0	-50.0
GLOVES, IV PAIR	B0213.	111	1	IN HSB (U2)	2.0	1033.0	-23.0	-50.0
HELMET ASSY, PRESSURE	B0214.	111	1	IN HSB (U2)	2.6	1033.0	-23.0	-50.0
HELMET ASSY, PRESSURE	B0214.	111	1	HELMET STOW BAG (B1)	2.6	1050.0	-27.0	39.0

3.1-66

SNA-8-D-027(111) REV 3

N
 U
 M
 B
 E
 R
 1
 2
 3
 4
 5
 6
 7
 8
 9
 10
 11
 12
 13
 14
 15
 16
 17
 18
 19
 20
 21
 22
 23
 24
 25
 26
 27
 28
 29
 30
 31
 32
 33
 34
 35
 36
 37
 38
 39
 40
 41
 42
 43
 44
 45
 46
 47
 48
 49
 50

Amendment 110
7/19/71

TABLE 3.1-9.2 (CONTINUED)

MISSION J-1 TRANSFERRED CREW AND EQUIPMENT STOWAGE LIST								
ITEMS REARRANGED IN CM PRIOR TO LM ACTIVATION (3)								
DESCRIPTION	STOW. ITEM	REF	NO.	STOWAGE LOCATION	WEIGHT	APOLLO COORDINATES		
						X-C.G.	Y-C.G.	Z-C.G.
HELMET ASSY, PRESSURE	B0214.	111	1	HELMET STOW.BAG (L3)	2.6	1048.0	-97.0	12.0
COMMUNICATION CARRIER	B0217.	111	1	IN HSB (U2)	1.6	1033.0	-23.0	-50.0
COMMUNICATION CARRIER	B0217.	111	1	HELMET STOW BAG (B1)	1.6	1050.0	-27.0	39.0
COMMUNICATION CARRIER	B0217.	111	1	HELMET STOW.BAG (L3)	1.6	1048.0	-97.0	12.0
POCKET,SCISSORS (CMP)	B0218.	111	1	ON ICG LH STA	.2	1043.0	-24.5	-11.9
POCKET,SCISSORS (COR)	B0218.	111	1	ON ICG CTR STA	.2	1043.0	.0	-11.9
POCKET,SCISSORS (LMP)	B0218.	111	1	ON ICG RH STA	.2	1043.0	24.5	-11.9
POCKET,CHECKLIST (COR)	B0219.	111	1	ON ICG CTR STA	.2	1043.0	.0	-11.9
POCKET,CHECKLIST (LMP)	B0219.	111	1	ON ICG RH STA	.2	1043.0	24.5	-11.9
POCKET,DATA(COR)	B0220.	111	1	ON ICG CTR STA	.2	1043.0	.0	-11.9
POCKET,DATA(LMP)	B0220.	111	1	ON ICG RH STA	.2	1043.0	24.5	-11.9
POCKET,CHECKLIST (CMP)	B0221.	111	1	ON ICG LH STA	.2	1043.0	-24.5	-11.9
POCKET,DATA(CMP)	B0222.	111	1	ON ICG LH STA	.2	1043.0	-24.5	-11.9
OOSIMETER, PASSIVE	D0201.	117	3	CWG POCKETS	NEGL	1041.0	.0	-11.9
OOSIMETER, PASSIVE	D0201.	117	3	CWG POCKETS	NEGL	1041.0	.0	-11.9
HEADSET,LIGHTWEIGHT	E0111.	111	1	ON CREW LH STA	.4	1043.0	-24.5	-11.9
HEADSET,LIGHTWEIGHT	E0112.	111	1	ON CREW CTR STA	.4	1043.0	.0	-11.9
HEADSET,LIGHTWEIGHT	E0113.	111	1	ON CREW RH STA	.4	1043.0	24.5	-11.9
EARTUBE,UNIVERSAL (CMP)	E0114.	111	1	ON ICG LH STA	NEGL	1043.0	-24.5	-11.9
EARTUBE,UNIVERSAL (COR)	E0115.	111	1	ON ICG CTR STA	NEGL	1043.0	.0	-11.9
EARTUBE,UNIVERSAL (LMP)	E0116.	111	1	ON ICG RH STA	NEGL	1043.0	24.5	-11.9
EARPIECE,MOULDED(COMM.CARRIER)	E0200.1	111	1	IN HSB (U2)	NEGL	1033.0	-23.0	-50.0
EARPIECE,MOULDED(COMM.CARRIER)	E0200.1	111	1	IN HSB (U2)	NEGL	1033.0	-23.0	-50.0
EARPIECE,MOULDED(COMM.CARRIER)	E0200.1	111	1	IN HSB (U2)	NEGL	1033.0	-23.0	-50.0
EARTUBE(COMM.CARRIER)	E0200.2	111	2	IN HSB (U2)	NEGL	1033.0	-23.0	-50.0
EARTUBE(COMM.CARRIER)	E0200.2	111	2	HELMET STOW BAG (B1)	NEGL	1050.0	-27.0	39.0
EARTUBE(COMM.CARRIER)	E0200.2	111	2	IN HSB (U2)	NEGL	1033.0	-23.0	-50.0
CM EQUIP.RELOC.2					174.31	1017.35	-3.24	-10.60

3.1-67

SNA-8-D-027(III) REV 3

TABLE 3.1-9.2 (CONTINUED)

MISSION J-1 TRANSFERRED CREW AND EQUIPMENT STORAGE LIST								
ITEMS REARRANGED IN CM PRIOR TO LM ACTIVATION (4)								
APOLLO COORDINATES								
DESCRIPTION	STOW. ITEM	REF	NO.	STOWAGE LOCATION	WEIGHT	X-C.G.	Y-C.G.	Z-C.G.
BAG,MOTION SICKNESS	A0208.	111	1	ON CREW	.1	1043.0	.0	-21.0
BAG,MOTION SICKNESS	A0208.	111	1	ON CREW	.1	1043.0	.0	-21.0
BAG,MOTION SICKNESS	A0208.	111	1	ON CREW	.1	1043.0	.0	-21.0
JACKET ASSY,ICG	B0112.1	111	1	AREA U2	1.8	1033.0	-23.0	-50.0
JACKET ASSY,ICG	B0112.1	111	1	AREA U2	1.8	1033.0	-23.0	-50.0
JACKET ASSY,ICG	B0112.1	111	1	AREA U2	1.8	1033.0	-23.0	-50.0
TROUSER ASSY,ICG	B0112.2	111	1	AREA U2	1.8	1033.0	-23.0	-50.0
TROUSER ASSY,ICG	B0112.2	111	1	AREA U2	1.8	1033.0	-23.0	-50.0
TROUSER ASSY,ICG	B0112.2	111	1	AREA U2	1.8	1033.0	-23.0	-50.0
BOOT,RIGHT,ICG	B0112.3	111	1	AREA U2	.4	1033.0	-23.0	-50.0
BOOT,RIGHT,ICG	B0112.3	111	1	AREA U2	.4	1033.0	-23.0	-50.0
BOOT,RIGHT,ICG	B0112.3	111	1	AREA U2	.4	1033.0	-23.0	-50.0
BOOT,LEFT, ICG	B0112.4	111	1	AREA U2	.4	1033.0	-23.0	-50.0
BOOT,LEFT, ICG	B0112.4	111	1	AREA U2	.4	1033.0	-23.0	-50.0
BOOT,LEFT, ICG	B0112.4	111	1	AREA U2	.4	1033.0	-23.0	-50.0
SUBSYSTEM,FECAL CONTAINMENT	B0113.	111	01	ON CREW CTR STA	.3	1043.0	.0	-11.9
SUBSYSTEM,FECAL CONTAINMENT	B0113.	111	01	ON CREW RH STA	.3	1043.0	24.5	-11.9
SUBSYSTEM,FECAL CONTAINMENT	B0113.	111	1	ON CREW LH STA	.3	1043.0	-24.5	-11.9
HARNESS,CWG ELECTRICAL (CMP)	B0135.	111	1	IN ADAPTER BAG(AB)	.4	1011.0	21.0	-23.0
HARNESS,CWG ELECTRICAL (CDR)	B0135.	111	1	IN ADAPTER BAG(AB)	.4	1011.0	21.0	-23.0
HARNESS,CWG ELECTRICAL (LMP)	B0135.	111	1	IN ADAPTER BAG(AB)	.4	1011.0	21.0	-23.0
UCTA	B0205.	111	1	ON CREW	.5	1043.0	.0	-5.9
UCTA	B0205.	111	1	ON CREW	.5	1043.0	.0	-5.9
UCTA	B0223.	111	1	ON CREW	.5	1043.0	.0	-5.9
ITLSA - EV	B0211.	111		ON CREW CTR STA	46.9	1043.0	.0	-11.9
ITLSA - EV	B0211.	111		ON CREW RH STA	46.9	1043.0	24.5	-11.9
ITLSA - EV	B0212.	111		ON CREW LH STA	41.8	1043.0	-24.5	-11.9
GLOVES,IV PAIR	B0213.	111	1	ON CREW LH STA	2.0	1043.0	-24.5	-11.9
GLOVES,IV PAIR	B0213.	111	1	ON CREW RH STA	2.0	1043.0	24.5	-11.9
GLOVES,IV PAIR	B0213.	111	1	ON CREW CTR STA	2.0	1043.0	.0	-11.9
HELMET ASSY, PRESSURE	B0214.	111	1	ON CREW LH STA	2.6	1043.0	-24.5	-11.9
HELMET ASSY, PRESSURE	B0214.	111	1	ON CREW RH STA	2.6	1043.0	24.5	-11.9

3.1-68

SNA-8-D-027(III) REV 3

N
 U
 T
 I
 L
 I
 T
 Y
 R
 E
 P
 O
 R
 T
 I
 N
 G
 I
 N
 F
 O
 R
 M
 A
 T
 I
 O
 N

TABLE 3.1-9.2 (CONTINUED)

MISSION J-1 TRANSFERRED CREW AND EQUIPMENT STOWAGE LIST								
ITEMS REARRANGED IN CM PRIOR TO LM ACTIVATION (4)								
						APOLLO COORDINATES		
DESCRIPTION	STOW. ITEM	REF	NO.	STOWAGE LOCATION	WEIGHT	X-C.G.	Y-C.G.	Z-C.G.
HELMET ASSY, PRESSURE	B0214.	111	1	ON CREW CTR STA	2.6	1043.0	.0	-11.9
COMMUNICATION CARRIER	B0217.	111	1	ON CREW LH STA	1.6	1043.0	-24.5	-11.9
COMMUNICATION CARRIER	B0217.	111	1	ON CREW RH STA	1.6	1043.0	24.5	-11.9
COMMUNICATION CARRIER	B0217.	111	1	ON CREW CTR STA	1.6	1043.0	.0	-11.9
POCKET,SCISSORS (CMP)	B0218.	111	1	ON PGA LH CREW STA	.2	1043.0	-24.5	-11.9
POCKET,SCISSORS (COR)	B0218.	111	1	ON PGA CT CREW STA	.2	1043.0	.0	-11.9
POCKET,SCISSORS (LMP)	B0218.	111	1	ON PGA RH CREW STA	.2	1043.0	24.5	-11.9
POCKET,CHECKLIST (COR)	B0219.	111	1	ON PGA CT CREW STA	.2	1043.0	.0	-11.9
POCKET,CHECKLIST (LMP)	B0219.	111	1	ON PGA RH CREW STA	.2	1043.0	24.5	-11.9
POCKET,DATA(COR)	B0220.	111	1	ON PGA CT CREW STA	.2	1043.0	.0	-11.9
POCKET,DATA(LMP)	B0220.	111	1	ON PGA RH CREW STA	.2	1043.0	24.5	-11.9
POCKET,CHECKLIST (CMP)	B0221.	111	1	ON PGA LH CREW STA	.2	1043.0	-24.5	-11.9
POCKET,DATA(CMP)	B0222.	111	1	ON PGA LH CREW STA	.2	1043.0	-24.5	-11.9
DOSIMETER, PASSIVE	D0201.	117	3	CWG POCKET(STOWEO)	NEGL	1015.0	.0	-19.0
DOSIMETER, PASSIVE	D0201.	117	3	CWG POCKET(STOWEO)	NEGL	1015.0	.0	-19.0
HEADSET, LIGHTWEIGHT	E0111.	111	1	AREA A8	.4	1011.0	21.0	-23.0
HEADSET, LIGHTWEIGHT	E0112.	111	1	AREA A8	.4	1011.0	21.0	-23.0
HEADSET, LIGHTWEIGHT	E0113.	111	1	AREA A8	.4	1011.0	21.0	-23.0
EARTUBE, UNIVERSAL (CMP)	E0114.	111	1	AREA U2	NEGL	1033.0	-23.0	-50.0
EARTUBE, UNIVERSAL (COR)	E0115.	111	1	AREA U2	NEGL	1033.0	-23.0	-50.0
EARTUBE, UNIVERSAL (LMP)	E0116.	111	1	AREA U2	NEGL	1033.0	-23.0	-50.0
EARPIECE, MOULDED (COMM. CARRIER)	E0200.1	111	1	ON CREW	NEGL	1050.0	.0	-24.0
EARPIECE, MOULDED (COMM. CARRIER)	E0200.1	111	1	ON CREW	NEGL	1050.0	.0	-24.0
EARPIECE, MOULDED (COMM. CARRIER)	E0200.1	111	1	ON CREW	NEGL	1050.0	.0	-24.0
EARTUBE (COMM. CARRIER)	E0200.2	111	2	ON CREW	NEGL	1050.0	.0	-24.0
EARTUBE (COMM. CARRIER)	E0200.2	111	2	ON CREW	NEGL	1050.0	.0	-24.0
EARTUBE (COMM. CARRIER)	E0200.2	111	2	ON CREW	NEGL	1050.0	.0	-24.0
CM EQUIP. RELOC.2					174.31	1041.00	-0.74	-14.90

3.1-69

SMA-8-D-027(III) REV 3

TABLE 3.1-9.2 (CONTINUED)

MISSION J-1 TRANSFERRED CREW AND EQUIPMENT STOWAGE LIST								
ITEMS TRANSFERRED FROM CM INTO LM AT LM ACTIVATION (5)								
APOLLO COORDINATES								
DESCRIPTION	STOW. ITEM	REF	NO.	STOWAGE LOCATION	WEIGHT	X-C.G.	Y-C.G.	Z-C.G.
CREW-COMMANDER(CDR)	N/A	227	1	ON COUCH(CTR CRW.STA	183.5	1043.0	.0	-10.4
CREW-LM PILOT(LMP)	N/A	227	1	ON COUCH(RH CREW STA	163.0	1043.0	24.5	-10.4
BAG,XFER,16MM MAGAZINE	06397.	111	1	AREA R13	.3	1024.0	45.0	-26.0
BAG,XFER,70MM MAGAZINE	06398.	111	2	AREA R13	.8	1024.0	45.0	-26.0
BAG, TRANSFER-16MM MAG.(2)	06432.	111	.01	AREA R13	.1	1024.0	45.0	-26.0
BAG, TRANSFER-70MM MAG (3)	06434.	111	.01	AREA R13	.5	1024.0	45.0	-26.0
BAG,16MM MAGAZINE XFR	06432.	111	1	AREA R13	.2	1024.0	45.0	-26.0
MAGAZINES,16MM	A0101.2	111	2	IN XFR BAG (R13)	2.0	1024.0	45.0	-26.0
MAGAZINE,16MM DATA ACQ.	A0101.1	116	5	IN XFR BAG (R13)	5.0	1024.0	45.0	-26.0
MAGAZINE,16MM DATA ACQ.	A0101.1	116	2	IN XFR BAG (R13)	2.0	1024.0	45.0	-26.0
MAGAZINE,16MM DATA ACQ.	A0101.1	116	1	IN XFR BAG (R13)	1.0	1024.0	45.0	-26.0
MAGAZINE,L.S.HASSELBLAD	A0108.1	116	3	IN XFR BAG (R13)	4.2	1024.0	45.0	-26.0
MAGAZINE,L.S.HASSELBLAD	A0108.1	116	1	IN XFR BAG (R13)	1.4	1024.0	45.0	-26.0
MAGAZINE,L.S.HASSELBLAD	A0108.1	116	3	IN XFR BAG (R13)	4.2	1024.0	45.0	-26.0
OOSIMETER,PASSIVE RADIATION	D0101.	111	1	IN XFR BAG (R13)	NEGL	1024.0	45.0	-26.0
MAGAZINE,L.S.HASSELBLAD	A0108.2	111	3	IN XFR BAG (R13)	4.4	1024.0	45.0	-26.0
MAGAZINE,L.S.HASSELBLAD	A0108.2	111	3	IN XFR BAG (A8)	4.2	1011.0	21.0	-23.0
LM XFR DATA CARD KIT	A0114.18	114	1	AREA R3	.6	1072.0	26.0	9.0
LM LUNAR SURFACE CHECKLIST	A0114.10	114	1	IN FDF (R3)	1.0	1072.0	26.0	9.0
LM SYSTEMS ACTIVATION CHK.LST.	A0114.12	114	1	IN FDF (R3)	.5	1072.0	26.0	9.0
LM SYSTEMS ACTIVATION CHK.LST.	A0114.12	114	1	IN FDF (R3)	.5	1072.0	26.0	9.0
LM LUNAR SURFACE MAPS	A0114.13	114	1	IN FDF (R3)	1.5	1072.0	26.0	9.0
LM TIMELINE BOOK	A0114.14	114	1	IN FDF (R3)	.5	1072.0	26.0	9.0
LM DATA CARD BOOK	A0114.19	114	1	IN FDF (R3)	.3	1072.0	26.0	9.0
LM RNDZ/ABORT BOOK	A0114.22	114	1	IN FDF (R3)	.3	1072.0	26.0	9.0
MONOCULAR 10X90	A0130.	116	1	AREA U4	.7	1038.0	39.0	-43.0
SUNGLASSES	A0200.	111	1	ON CREW	.1	1042.8	-7.6	-20.7
SUNGLASSES	A0200.	111	1	ON CREW	.1	1042.8	-7.6	-20.7
POUCH,SUNGLASSES	A0201.	111	1	ON CREW	NEGL	1042.8	-7.6	-20.7
POUCH,SUNGLASSES	A0201.	111	1	ON CREW	NEGL	1042.8	-7.6	-20.7
CHRONOGRAPH - 002	A0202.	111	1	ON CREW	.1	1050.0	.0	-14.9
CHRONOGRAPH - 002	A0202.	111	1	ON CREW	.1	1050.0	.0	-14.9

3.1-70

SNA-8-D-027(111) REV 3

TABLE 3.1-9.2 (CONTINUED)

MISSION J-1 TRANSFERRED CREW AND EQUIPMENT STORAGE LIST							APOLLO COORDINATES		
ITEMS TRANSFERRED FROM CM INTO LM AT LM ACTIVATION (5)							X-C.G.	Y-C.G.	Z-C.G.
DESCRIPTION	STOW. ITEM	REF	NO.	STORAGE LOCATION	WEIGHT				
WATCHBAND	A0203.	111	1	ON CREW	NEGL	1050.0	.0	-14.9	
WATCHBAND	A0203.	111	1	ON CREW	NEGL	1050.0	.0	-14.9	
PENS,DATA RECORDING	A0204.	111	1	ON CREW	.1	1042.8	12.5	-20.7	
PENS,DATA RECORDING	A0204.	111	1	ON CREW	.1	1042.8	12.5	-20.7	
PEN,HARKER	A0205.	111	1	ON CREW	NEGL	1042.8	12.5	-20.7	
PEN,HARKER	A0205.	111	1	ON CREW	NEGL	1042.8	12.5	-20.7	
PENCIL	A0206.	111	1	ON CREW	.1	1042.8	12.5	-20.7	
PENCIL	A0206.	111	1	ON CREW	.1	1042.8	12.5	-20.7	
GARMENT,LIQUID COOLING,CDR	B0107.	111	1	AREA U1	4.3	1033.0	23.0	-50.0	
GARMENT,LIQUID COOLING,LMP	B0107.	111	1	AREA U1	4.3	1033.0	23.0	-50.0	
SUBSYSTEM,FECAL CONTAINMENT	B0113.	111	01	ON CREW CTR STA	.3	1043.0	.0	-11.9	
SUBSYSTEM,FECAL CONTAINMENT	B0113.	111	01	ON CREW RH STA	.3	1043.0	24.5	-11.9	
HARNESS,CWG ELECTRICAL (COR)	B0135.	111	1	IN ADAPTER BAG(AB)	.4	1011.0	21.0	-23.0	
HARNESS,CWG ELECTRICAL (LMP)	B0135.	111	1	IN ADAPTER BAG(AB)	.4	1011.0	21.0	-23.0	
SCISSORS	B0204.	111	1	ON CREW	.5	1047.2	.0	-23.4	
UCTA	B0205.	111	1	ON CREW	.5	1043.0	.0	-5.9	
UCTA	B0205.	111	1	ON CREW	.5	1043.0	.0	-5.9	
PENLIGHTS	B0206.	111	1	ON CREW	.3	1042.8	-7.6	-20.7	
PENLIGHTS	B0206.	111	1	ON CREW	.3	1042.8	-7.6	-20.7	
BIOBELT ASSY	B0207.	111	1	ON CREW	.2	1041.0	.0	-12.9	
BIOBELT ASSY	B0207.	111	1	ON CREW	.2	1041.0	.0	-12.9	
GARMENT,CONSTANT WEAR	B0208.	111	1	ON CREW	.8	1041.0	.0	-11.4	
GARMENT,CONSTANT WEAR	B0208.	111	1	ON CREW	.8	1041.0	.0	-11.4	
EARPLUGS	B0210.	111	1	ON CREW	NEGL	1050.0	.0	-24.0	
EARPLUGS	B0210.	111	1	ON CREW	NEGL	1050.0	.0	-24.0	
ITLSA - EV	B0211.	111	1	ON CREW CTR STA	46.9	1043.0	.0	-11.9	
ITLSA - EV	B0211.	111	1	ON CREW RH STA	46.9	1043.0	24.5	-11.9	
GLOVES,IV PAIR	B0213.	111	1	ON CREW RH STA	2.0	1043.0	24.5	-11.9	
GLOVES,IV PAIR	B0213.	111	1	ON CREW CTR STA	2.0	1043.0	.0	-11.9	
HELMET ASSY, PRESSURE	B0214.	111	1	ON CREW RH STA	2.6	1043.0	24.5	-11.9	
HELMET ASSY, PRESSURE	B0214.	111	1	ON CREW CTR STA	2.6	1043.0	.0	-11.9	
HARNESS,ELEC - SUIT	B0224.	111	1	ON CREW CTR STA	.5	1043.0	.0	-11.9	

3.1-71

SNA-8-D-027(III) REV 3

TABLE 3.1-9.2 (CONTINUED)

Amendment 110
7/19/71

MISSION J-1 TRANSFERRED CREW AND EQUIPMENT STOWAGE LIST							APOLLO COORDINATES		
ITEMS TRANSFERRED FROM CM INTO LM AT LM ACTIVATION (5)							X=C.G.	Y=C.G.	Z=C.G.
DESCRIPTION	STOW. ITEM	REF	NO.	STOWAGE LOCATION	WEIGHT				
HARNESS,ELEC - SUIT	B0224.	111	1	ON CREW RH STA	.5	1043.0	24.5	-11.9	
HARNESS, BIOINSTRUMENTATION	B0216.	111	1	ON CREW CTR STA	.3	1043.0	.0	-11.9	
HARNESS, BIOINSTRUMENTATION	B0216.	111	1	ON CREW RH STA	.3	1043.0	24.5	-11.9	
COMMUNICATION CARRIER	B0217.	111	1	ON CREW RH STA	1.6	1043.0	24.5	-11.9	
COMMUNICATION CARRIER	B0217.	111	1	ON CREW CTR STA	1.6	1043.0	.0	-11.9	
POCKET,SCISSORS (CDR)	B0218.	111	1	ON PGA CT CREW STA	.2	1043.0	.0	-11.9	
POCKET,SCISSORS (LMP)	B0218.	111	1	ON PGA RH CREW STA	.2	1043.0	24.5	-11.9	
POCKET,CHECKLIST (CDR)	B0219.	111	1	ON PGA CT CREW STA	.2	1043.0	.0	-11.9	
POCKET,CHECKLIST (LMP)	B0219.	111	1	ON PGA RH CREW STA	.2	1043.0	24.5	-11.9	
POCKET,DATA(CDR)	B0220.	111	1	ON PGA CT CREW STA	.2	1043.0	.0	-11.9	
POCKET,DATA(LMP)	B0220.	111	1	ON PGA RH CREW STA	.2	1043.0	24.5	-11.9	
ASSY,BIOINSTRUMENTATION	C0201.	111	1	ON CREW	1.1	1041.0	.0	-12.9	
ASSY,BIOINSTRUMENTATION	C0201.	111	1	ON CREW	1.1	1041.0	.0	-12.9	
OOSINETER,PERSONAL	D0200.	117	1	ON CREW	.4	1046.0	.0	-23.4	
OOSINETER,PERSONAL	D0200.	117	1	ON CREW	.4	1046.0	.0	-23.4	
OOSINETER, PASSIVE	D0201.	117	3	CWG POCKET(STOWED)	NEGL	1015.0	.0	-19.0	
OOSINETER, PASSIVE	D0201.	117	3	CWG POCKET(STOWED)	NEGL	1015.0	.0	-19.0	
HEADSET,LIGHTWEIGHT	E0112.	111	1	AREA A8	.4	1011.0	21.0	-23.0	
HEADSET,LIGHTWEIGHT	E0113.	111	1	AREA A8	.4	1011.0	21.0	-23.0	
EARPIECE,MOULDED(COMM.CARRIER)	F0200.1	111	1	ON CREW	NEGL	1050.0	.0	-24.0	
EARPIECE,MOULDED(COMM.CARRIER)	E0200.1	111	1	ON CREW	NEGL	1050.0	.0	-24.0	
EARTUBE(COMM.CARRIER)	E0200.2	111	2	ON CREW	NEGL	1050.0	.0	-24.0	
EARTUBE(COMM.CARRIER)	E0200.2	111	2	ON CREW	NEGL	1050.0	.0	-24.0	
BAG,70MM MAGAZINE XFR	06466.	111	1	AREA A8	.3	1011.0	21.0	-23.0	
BAG,70MM MAGAZINE XFR	06466.	111	1	AREA R13	.3	1024.0	45.0	-26.0	
UTILITY STRAP	06315.	111	3	AREA R-5	.1	1059.0	44.0	15.0	
INFLIGHT RETAINER STRAPS	00360.	111	4	AREA R-5	.1	1059.0	44.0	15.0	
2 CREW+EQUIP,CM-LM					511.22	1041.74	13.73	-12.25	

3.1-72

SMA-8-D-027(III) REV 3

TABLE 3.1-9.2 (CONTINUED)

MISSION J-1 TRANSFERRED CREW AND EQUIPMENT STOWAGE LIST								
ITEMS TRANSFERRED FROM CM INTO LM AT LM ACTIVATION (6)								
						LM COORDINATES		
DESCRIPTION	STOW. ITEM	REF	NO.	STOWAGE LOCATION	WEIGHT	X-C.G.	Y-C.G.	Z-C.G.
CREW-COMMANDER (CDR)	N/A	227	1	CREW STATION - LM	183.5	252.0	-22.0	44.0
CREW-LM PILOT (LMP)	N/A	227	1	CREW STATION - RH	163.0	252.0	22.0	38.0
BAG, XFER, 16MM MAGAZINE	06397.	111	1	F7L	.3	231.8	36.0	47.3
BAG, XFER, 70MM MAGAZINE	06398.	111	2	F7D	.8	238.0	38.0	38.4
BAG, TRANSFER-16MM MAG. (2)	06432.	111	01	1SA (F6)	.1	270.0	.0	52.8
BAG, TRANSFER-70MM MAG (3)	06434.	111	01	F7P	.5	241.0	38.0	53.4
BAG, 16MM MAGAZINE XFR	06432.	111	1	CONTAINER A14A	.2	243.7	-5.5	-14.8
MAGAZINES, 16MM	A0101.2	111	2	CONTAINER A14A	2.0	243.7	-5.5	-14.8
MAGAZINE, 16MM DATA ACQ.	A0101.1	116	5	1N XFR BAG(F7L)	5.0	231.8	36.0	47.3
MAGAZINE, 16MM DATA ACQ.	A0101.1	116	2	1SA (F6)	2.0	270.0	.0	52.8
MAGAZINE, 16MM DATA ACQ.	A0101.1	116	1	ON CAMERA (F5)	1.0	286.0	17.8	66.6
MAGAZINE, L.S. HASSELBLAD	A0108.1	116	3	1N XFR BAG(F7D)	4.2	238.0	38.0	38.4
MAGAZINE, L.S. HASSELBLAD	A0108.1	116	1	ON CAMERA (F7C)	1.4	242.8	38.0	41.0
MAGAZINE, L.S. HASSELBLAD	A0108.1	116	3	1N XFR BAG(F7P)	4.2	241.0	38.0	53.4
DOSIMETER, PASSIVE RADIATION	DO101.	111	1	1N XFR BAG(F7L)	NEGL	231.8	36.0	47.3
MAGAZINE, L.S. HASSELBLAD	A0108.2	111	3	A14A	4.4	243.7	-5.5	-14.8
MAGAZINE, L.S. HASSELBLAD	A0108.2	111	3	A14A	4.2	243.7	-5.5	-14.8
LM XFR DATA CARD KIT	A0114.18	114	1	A1A	.6	280.0	-19.0	13.5
LM LUNAR SURFACE CHECKLIST	A0114.10	114	1	LM XFR DATA CARD KIT	1.0	280.0	-19.0	13.5
LM SYSTEMS ACTIVATION CHK. LST.	A0114.12	114	1	LM XFR DATA CARD KIT	.5	280.0	-19.0	13.5
LM SYSTEMS ACTIVATION CHK. LST.	A0114.12	114	1	LM XFR DATA CARD KIT	.5	280.0	-19.0	13.5
LM LUNAR SURFACE MAPS	A0114.13	114	1	LM XFR DATA CARD KIT	1.5	280.0	-19.0	13.5
LM TIMELINE BOOK	A0114.14	114	1	LM XFR DATA CARD KIT	.5	280.0	-19.0	13.5
LM DATA CARD BOOK	A0114.19	114	1	LM XFR DATA CARD KIT	.3	280.0	-19.0	13.5
LM RNDZ/ABORT BOOK	A0114.22	114	1	LM XFR DATA CARD KIT	.3	280.0	-19.0	13.5
MONOCULAR 10X40	A0130.	116	1	F7B	.7	238.4	38.6	46.0
SUNGLASSES	A0200.	111	1	ON CREW(LH CREW STA)	.1	252.0	-22.0	44.0
SUNGLASSES	A0200.	111	1	ON CREW(RH CREW STA)	.1	252.0	22.0	38.0
POUCH, SUNGLASSES	A0201.	111	1	ON CREW(LH CREW STA)	NEGL	252.0	-22.0	44.0
POUCH, SUNGLASSES	A0201.	111	1	ON CREW(RH CREW STA)	NEGL	252.0	22.0	38.0
CHRONOGRAPH - 002	A0202.	111	1	ON CREW(LH CREW STA)	.1	252.0	-22.0	44.0
CHRONOGRAPH - 002	A0202.	111	1	ON CREW(RH CREW STA)	.1	252.0	22.0	38.0

3.1-73

SNA-8-D-027(III) REV 3

TABLE 3.1-9.2 (CONTINUED)

MISSION J-1 TRANSFERRED CREW AND EQUIPMENT STORAGE LIST								
ITEMS TRANSFERRED FROM CM INTO LM AT LM ACTIVATION (6)								
DESCRIPTION	STOW. ITEM	REF	NO.	STOWAGE LOCATION	WEIGHT	LM COORDINATES		
						X-C.G.	Y-C.G.	Z-C.G.
WATCHBAND	A0203.	111	1	ON CREW(LH CREW STA)	NEGL	252.0	-22.0	44.0
WATCHBAND	A0203.	111	1	ON CREW(RH CREW STA)	NEGL	252.0	22.0	38.0
PENS, DATA RECORDING	A0204.	111	1	ON CREW(LH CREW STA)	.1	252.0	-22.0	44.0
PENS, DATA RECORDING	A0204.	111	1	ON CREW(RH CREW STA)	.1	252.0	22.0	38.0
PEN, MARKER	A0205.	111	1	ON CREW(LH CREW STA)	NEGL	252.0	-22.0	44.0
PEN, MARKER	A0205.	111	1	ON CREW(RH CREW STA)	NEGL	252.0	22.0	38.0
PENCIL	A0206.	111	1	ON CREW(LH CREW STA)	.1	252.0	-22.0	44.0
PENCIL	A0206.	111	1	ON CREW(RH CREW STA)	.1	252.0	22.0	38.0
GARMENT, LIQUID COOLING, CDR	B0107.	111	1	ISA (F6)	4.3	270.0	.0	52.8
GARMENT, LIQUID COOLING, LMP	B0107.	111	1	ISA (F6)	4.3	270.0	.0	52.8
SUBSYSTEM, FECAL CONTAINMENT	B0113.	111	.01	ON CREW(LH CREW STA)	.3	252.0	-22.0	44.0
SUBSYSTEM, FECAL CONTAINMENT	B0113.	111	.01	ON CREW(RH CREW STA)	.3	252.0	22.0	38.0
HARNESS, CWG ELECTRICAL (COR)	B0135.	111	1	FIE	.4	237.9	-33.6	55.0
HARNESS, CWG ELECTRICAL (LMP)	B0135.	111	1	FIE	.4	237.9	-33.6	55.0
SCISSORS	B0204.	111	1	ON CREW(RH CREW STA)	.5	252.0	22.0	38.0
UCTA	B0205.	111	1	ON PGA-LMP (ON CREW)	.5	252.0	22.0	38.0
UCTA	B0205.	111	1	ON PGA-CDR (ON CREW)	.5	252.0	-22.0	44.0
PENLIGHTS	B0206.	111	1	ON CREW(LH CREW STA)	.3	252.0	-22.0	44.0
PENLIGHTS	B0206.	111	1	ON CREW(RH CREW STA)	.3	252.0	22.0	38.0
BIOBELT ASSY	B0207.	111	1	ON CREW(LH CREW STA)	.2	252.0	-22.0	44.0
BIOBELT ASSY	B0207.	111	1	ON CREW(RH CREW STA)	.2	252.0	22.0	38.0
GARMENT, CONSTANT WEAR	B0208.	111	1	ON CREW(LH CREW STA)	.8	252.0	-22.0	44.0
GARMENT, CONSTANT WEAR	B0208.	111	1	ON CREW(RH CREW STA)	.8	252.0	22.0	38.0
EARPLUGS	R0210.	111	1	ON CREW(RH CREW STA)	NEGL	252.0	22.0	38.0
EARPLUGS	R0210.	111	1	ON CREW(LH CREW STA)	NEGL	252.0	-22.0	44.0
ITLSA - EV	B0211.	111	1	ON CREW(LH CREW STA)	46.9	252.0	-22.0	44.0
ITLSA - EV	R0211.	111	1	ON CREW(RH CREW STA)	46.9	252.0	22.0	38.0
GLOVES, IV PAIR	B0213.	111	1	ON CREW(RH CREW STA)	2.0	252.0	22.0	38.0
GLOVES, IV PAIR	B0213.	111	1	ON CREW(LH CREW STA)	2.0	252.0	-22.0	44.0
HELMET ASSY, PRESSURE	B0214.	111	1	ON CREW(RH CREW STA)	2.6	252.0	22.0	38.0
HELMET ASSY, PRESSURE	B0214.	111	1	ON CREW(LH CREW STA)	2.6	252.0	-22.0	44.0
HARNESS, ELEC - SUIT	B0224.	111	1	ON CREW(RH CREW STA)	.5	252.0	22.0	38.0

3.1-74

SNA-8-D-027(III) REV 3

U
N
I
T
E
D
S
T
A
T
E
S
O
F
A
M
E
R
I
C
A

Amendment 110
7/19/71

TABLE 3.1-9.2 (CONTINUED)

MISSION J-1 TRANSFERRED CREW AND EQUIPMENT STOWAGE LIST								
ITEMS TRANSFERRED FROM LM INTO CM AT LM ACTIVATION (8)								
APOLLO COORDINATES								
DESCRIPTION	STOW. ITEM	REF	NO.	STOWAGE LOCATION	WEIGHT	X-C.G.	Y-C.G.	Z-C.G.
CSM/LM UMBILICAL	TBD	222	1	UNDER RH COUCH	1.1	1018.0	24.5	-15.0
EQUIP.XFR,LM-CM 1					1.10	1018.00	24.50	-15.00

3.1-77

SNA-8-D-027 (III) REV 3

TABLE 3.1-9.2 (CONTINUED)

Amendment 110
7/19/71

MISSION J-1 TRANSFERRED CREW AND EQUIPMENT STORAGE LIST								
ITEMS REARRANGED IN LM PRIOR TO LM ACTIVATION (9)								
DESCRIPTION	STOW. ITEM	REF	NO.	STORAGE LOCATION	WEIGHT	LM COORDINATES		
						X-C.G.	Y-C.G.	Z-C.G.
INTERIM STORAGE ASSY.	03007.	111	• 1	F6	6.4	270.0	.0	52.8
BAG, TRANSFER-16MM MAG.(2)	06432.	111	•1	ISA (F6)	.1	270.0	.0	52.8
MAGAZINE,16MM DATA ACQ.	A0101.1	116	2	ISA (F6)	2.0	270.0	.0	52.8
BRACKET,WEDGE,16MM CAMERA	A1041.	115	1	F7A	1.3	238.0	38.0	49.8
GARMENT,LIQUID COOLING,COR	B0107.	111	1	ISA (F6)	4.3	270.0	.0	52.8
GARMENT,LIQUID COOLING,LMP	R0107.	111	1	ISA (F6)	4.3	270.0	.0	52.8
BRUSH,LENS	A1042.	111	1	ISA (F6)	.1	270.0	.0	52.8
LM EQUIP.RELOC.1					18.50	267.75	2.67	52.59

3.1-78

SNA-8-D-027(III) REV 3

TABLE 3.1-9.2 (CONTINUED)

MISSION J-1 TRANSFERRED CREW AND EQUIPMENT STOWAGE LIST								
ITEMS REARRANGED IN LM PRIOR TO LM ACTIVATION (10)								
DESCRIPTION	STOW. ITEM	REF	NO.	STOWAGE LOCATION	WEIGHT	LM COORDINATES		
						X-C.G.	Y-C.G.	Z-C.G.
INTERIM STOWAGE ASSY.	03007.	111	• 1	A3	6.4	280.0	.0	-10.0
BAG, TRANSFER-16MM MAG.(2)	06432.	111	• 1	1SA(ON A3)	.1	280.0	.0	-10.0
MAGAZINE,16MM DATA ACQ.	A0101.1	116	2	1SA(ON A3)	2.0	280.0	.0	-10.0
BRACKET,WEDGE,16MM CAMERA	A1041.	115	1	F5	1.3	286.0	17.8	66.6
GARMENT,LIQUID COOLING,CDR	B0107.	111	1	1SA(ON A3)	4.3	280.0	.0	-10.0
GARMENT,LIQUID COOLING,LMP	B0107.	111	1	1SA(ON A3)	4.3	280.0	.0	-10.0
BRUSH,LENS	A1042.	111	1	1SA(ON A3)	.1	280.0	.0	-10.0
LM EQUIP.RELOC.1					18.50	280.42	1.25	-9.62

3.1-79

TABLE 3.1-9.2 (CONTINUED)

MISSION J-1 TRANSFERRED CREW AND EQUIPMENT STOWAGE LIST							LM COORDINATES		
ITEMS OFFLOADED FROM ASC. STAGE PRIOR TO LUNAR LIFT-OFF (II)							X-C.G.	Y-C.G.	Z-C.G.
DESCRIPTION	STOW. ITEM	REF	NO.	STOWAGE LOCATION	WEIGHT	X-C.G.	Y-C.G.	Z-C.G.	
ARM RESTS	TBD	346	3	CREW STATION	3.3	251.4	3.5	56.3	
ARM RESTS	TBD	346	1	CREW STATION	1.1	251.4	-10.3	56.8	
CAMERA, HASSELBLAD-ELEC DATA	A1015.	111	1	F7C	3.1	242.8	38.0	41.0	
LENS, 60 MM	A1016.	115	1	ON CAMERA (F7C)	1.7	242.8	38.0	41.0	
PROTECTIVE COVER, RESEAU	A1023.	115	1	ON CAMERA (F7C)	.2	242.8	38.0	41.0	
TRIGGER, ELECT. HASSELBLAD	A1027.	115	1	ON CAMERA (F7C)	.2	242.8	38.0	41.0	
HANDLE, ELECT. HASSELBLAD	A1028.	115	1	ON CAMERA (F7C)	.5	242.8	38.0	41.0	
BAG, 500MM SYS/LRV STOWAGE	O3080.	111	1	AFT ENG CAN(A19A)	4.4	239.6	-5.5	-14.8	
PROTECTIVE COVER, RESEAU	A1023.	111	1	AFT ENG CAN(A19A)	.2	239.6	-5.5	-14.8	
TRIGGER, HASSELBLAD-ELEC DATA	A1027.	111	1	AFT ENG CAN(A19A)	.2	239.6	-5.5	-14.8	
HANDLE, HASSELBLAD-ELEC DATA	A1028.	111	1	AFT ENG CAN(A19A)	.5	239.6	-5.5	-14.8	
CAMERA, L.S. ELECTRIC	A1045.	111	1	AFT ENG CAN(A19A)	3.1	239.6	-5.5	-14.8	
LENS, 500MM	A1046.	111	1	AFT ENG CAN(A19A)	4.6	239.6	-5.5	-14.8	
RINGSIGHT	A1047.	111	1	AFT ENG CAN(A19A)	.1	239.6	-5.5	-14.8	
BRACKET, CAMERA MOUNT	B1001.1	111	1	AFT ENG CAN(A19A)	.6	239.6	-5.5	-14.8	
TETHER, EVA RETRACTABLE	A1029.	115	1	NEAR PLSS	.2	268.8	-4.6	44.4	
TETHER, EVA RETRACTABLE	A1044.	111	1	NEAR PLSS	.7	268.8	-4.6	44.4	
MAGAZINES, 70MM LUNAR SURFACE	A0108.1	111	3	IN XFR BAG(F7D)	4.2	238.0	38.0	38.4	
MAGAZINE, 70MM LUNAR SURFACE	A0108.1	111	1	IN XFR BAG(F90)	1.4	238.0	38.0	38.4	
MAGAZINE, 70MM LUNAR SURFACE	A0108.1	111	2	F7P	2.8	241.0	38.0	53.4	
MAGAZINE, 70MM LUNAR SURFACE	A0108.1	111	4	AFT ENG COVER	5.6	243.7	-5.5	-14.8	
MAGAZINE, 70MM LUNAR SURFACE	A0108.1	111	2	AFT ENG COVER	2.8	243.7	-5.5	-14.8	
MAGAZINE, 70MM LUNAR SURFACE	A0108.1	111	1	IN XFR BAG(F7D)	1.4	238.0	38.0	38.4	
MAGAZINE, 16MM	A0101.1	111	5	RHSSC	5.0	231.8	36.0	47.3	
MAGAZINE, 16MM	A0101.1	111	2	ISA(ON A3)	2.0	280.0	.0	-10.0	
MAGAZINE, 16M	A0101.1	111	2	AFT ENG COVER	2.0	243.7	-5.5	-14.8	
MAGAZINE, 16MM	A0101.1	111	1	F5	1.0	286.0	17.8	66.6	
GARMENT, LIQUID COOLING, COR	B0107.	111	1	ISA(ON A3)	4.3	280.0	.0	-10.0	
GARMENT, LIQUID COOLING, LMP	B0107.	111	1	ISA(ON A3)	4.3	280.0	.0	-10.0	
GARMENT, CONSTANT WEAR	B0208.	111	1	ON CREW(LH CREW STA)	.8	252.0	-22.0	44.0	
GARMENT, CONSTANT WEAR	B0208.	111	1	ON CREW(RH CREW STA)	.8	252.0	22.0	38.0	
EARPLUGS	B0210.	111	1	ON CREW(RH CREW STA)	NEGL	252.0	22.0	38.0	

3.1-80

SNA-8-D-027(III) REV 3

U N I T E D S T A T E S A R M Y

TABLE 3.1-9.2 (CONTINUED)

MISSION J-1 TRANSFERRED CREW AND EQUIPMENT STORAGE LIST								
ITEMS OFFLOADED FROM ASC. STAGE PRIOR TO LUNAR LIFT-OFF (II)								
DESCRIPTION	STOW. ITEM	REF	NO.	STOWAGE LOCATION	WEIGHT	LM COORDINATES		
						X-C.G.	Y-C.G.	Z-C.G.
EARPLUGS	80210.	111	1	ON CREW(LH CREW STA)	NEGL	252.0	-22.0	44.0
REMOTE CONTROL UNIT-PLSS	81001.	115	2	A12	10.2	272.0	.0	-18.0
BRACKET, CAMERA MOUNT	81001.1	115	1	ON CAMERA (F7C)	.6	242.8	38.0	41.0
UTILITY TOWEL ASSEMBLY, LM	81008.	115	2	F1D	.6	242.8	-35.4	47.2
DEFECATION COLLECTION DEVICE	81009.	115	3	F1F	.6	235.5	-37.6	46.6
URINE BAGS	T8D	111	2	F1F	.6	235.5	-37.6	46.6
BOOTS,LUNAR PAIR	81018.	115	1	A1L	4.5	281.0	-20.0	-8.5
BOOTS, LUNAR PAIR	81018.	115	1	A1K	4.5	273.7	-20.0	-8.5
BAG ASSY, LEC + W.T.	81020.1	115	1	F7N	.2	238.0	38.0	53.1
CONVEYOR ASSY, LUNAR EQUIP.	81020.2	115	1	F7N	1.3	238.0	38.0	53.1
BAG, DEPLOYMENT, LEC	81020.3	115	1	F7N	.1	238.0	38.0	53.1
PLSS/EVCS ASSY (ORY)	81024.	111	1	RECHARGE STATION	88.8	263.5	-20.6	14.9
PLSS/EVCS ASSY (ORY)	81025.	111	1	FLOOR	88.7	219.9	-1.3	44.5
BAG,JETTISON STOWAGE	81027.	115	4	A1G	3.6	257.5	-20.0	-18.0
DISPENSER, TISSUE	81033.	116	1	F1E	1.4	237.9	-33.6	55.0
ADAPTER, LIQUID COOLING GARMENT	81036.	116	2	F7E	.4	243.2	38.0	31.2
JACKET ASSY, ICG	81039.1	116	2	A1C (ICG ASSY)	3.6	240.5	-15.3	13.3
TROUSER ASSY, ICG	81039.2	116	2	A1C (ICG ASSY)	3.6	240.5	-15.3	13.3
BOOT, RIGHT, ICG	81039.3	116	2	A1C (ICG ASSY)	.8	240.5	-15.3	13.3
BOOT, LEFT, ICG	81039.4	116	2	A1C (ICG ASSY)	.8	240.5	-15.3	13.3
TOWELS,LM UTILITY(RED)	81043.	115	2	F1G	.2	228.0	-40.2	43.2
TOWELS,LM UTILITY(BLUE)	81044.	115	2	F1G	.2	228.0	-40.2	43.2
SLEEP RESTRAINT ASSY	81061.	111	2	ON FLOOR - PLSS	5.2	226.5	-1.5	50.5
CONTAINER, BUOY SLSS ASSY	03059.	111	1	ON PLUS 227 BULKHEAD	3.8	221.8	-1.0	29.5
BUOY SLSS ASSY	81052.	116	1	ON PLUS 227 BULKHEAD	7.3	221.8	-1.0	29.5
TOOL CARRIER, PLSS(CDR)	81063.	111	1	ON PLUS 227 BULKHEAD	1.5	221.8	-1.0	29.5
TOOL CARRIER, PLSS (LMP)	81064.	111	1	ON PLUS 227 BULKHEAD	1.5	221.8	-1.0	29.5
FOOD ASSY, LM	C1002.	165	1	MINUS 227 BULKHEAD	3.3	288.0	.0	-24.0
WIPES, WET, FACIAL	C1005.0	115	5	F1A	NEGL	244.5	-36.6	31.4
CONTR. CONTINGENCY, LUN. SAM. RTN	G4016.	115	1	A1G	.8	257.5	-20.0	-18.0
ADAPTER, SRC/OPS	03004.	115	1	LH AFT MID-SEC.	2.5	261.6	-25.6	-6.0
ADAPTER, SRC/OPS	03004.	115	1	LH AFT MID-SEC.	2.6	261.6	-25.6	-6.0

3.1-81

SNA-8-D-027(III) REV 3

TABLE 3.1-9.2 (CONTINUED)

Amendment 110
7/19/71

MISSION J-1 TRANSFERRED CREW AND EQUIPMENT STORAGE LIST								
ITEMS OFFLOADED FROM ASC. STAGE PRIOR TO LUNAR LIFT-OFF (III)								
DESCRIPTION	STOW. ITEM	REF	NO.	STOWAGE LOCATION	WEIGHT	LM COORDINATES		
						X-C.G.	Y-C.G.	Z-C.G.
CANISTER, ECS LIQH	03009.	115	1	A10	9.2	250.0	8.0	-11.8
BAG, EMESIS	03011.	115	3	F1F	.6	235.5	-37.6	46.6
STRAP, ECS LIQH CANNISTER	03024.	115	1	A10	.1	250.0	8.0	-11.8
HOLDER, MAP-LRV	R1002	111	1	FLIGHT DATA FILE	.5	282.2	-18.5	12.2
URINE RECEPTACLE SYSTEM	03039.	115	1	F1C	.6	242.5	-35.6	38.5
HAMMOCK ASSY.	03048.	115	1	F1G	4.0	228.0	-40.2	43.2
HAMMOCK ASSY.	03050.	115	1	F1G	3.9	228.0	-40.2	43.2
WEBBING, TIEDOWN-CONTINGENCY	03069.	111	1	F7J	.4	231.5	35.4	41.8
STRAP ASSY, SLEEP RESTRAINT	03082.		2	ON FLOOR - PLSS	.2	226.5	-1.5	80.8
LEFT AT LUNAR SITE					326.40	244.75	-6.63	21.69

3.1-82

SNA-8-D-027(III) REV 3

U
 N
 I
 T
 E
 D
 S
 T
 A
 T
 E
 S
 P
 A
 C
 E
 S
 H
 I
 P
 S
 P
 E
 C
 I
 A
 L
 I
 T
 E
 M
 S
 L
 I
 S
 T
 I
 N
 G

TABLE 3.1-9.2 (CONTINUED)

Amendment 110
7/19/71

MISSION J-1 TRANSFERRED CREW AND EQUIPMENT STOWAGE LIST								
ITEMS ONLOADED INTO ASC. STAGE PRIOR TO LUNAR LIFT-OFF (12)								
LM COORDINATES								
DESCRIPTION	STOW. ITEM	REF	NO.	STOWAGE LOCATION	WEIGHT	X-C.G.	Y-C.G.	Z-C.G.
EXP,SOLAR WIND COMPOSITION BAG,SAMPLE CONTAINER	G4011.03078.	111	1	ISA(ON A3)	.2	280.0	.0	-10.0
SAMPLE COLLECTION BAG 2 AND 6	G4048.	115	2	ISA(ON A3)	2.4	280.0	.0	-10.0
SAMPLES IN BAGS 2 AND 6	N/A	115	2	ISA(ON A3)	17.2	280.0	.0	-10.0
BAG,SWC EXPERIMENT - STOWAGE	G4055.	111	1	ISA(ON A3)	.2	280.0	.0	-10.0
MAGAZINES,70MM LUNAR SURFACE	A0108.1	111	3	IN XFR BAG(F7D)	4.2	238.0	38.0	38.4
MAGAZINE,70MM LUNAR SURFACE	A0108.1	111	1	F7P	1.4	241.0	38.0	53.4
MAGAZINE,70MM LUNAR SURFACE	A0108.1	111	2	F7P	2.8	241.0	38.0	53.4
MAGAZINE,70MM LUNAR SURFACE	A0108.1	111	4	AIC	5.6	240.5	-18.0	13.3
MAGAZINE,70MM LUNAR SURFACE	A0108.1	111	2	AIC	2.8	240.5	-18.0	13.3
MAGAZINE,70MM LUNAR SURFACE	A0108.1	111	1	F7P	1.4	241.0	38.0	53.4
MAGAZINE,16MM	A0101.1	111	5	RHSSC	5.0	231.8	36.0	47.3
MAGAZINE,16MM	A0101.1	111	2	ISA(ON A3)	2.0	280.0	.0	-10.0
MAGAZINE,16H	A0101.1	111	2	AIK	2.0	273.7	-20.0	-8.5
MAGAZINE,16MM	A0101.1	111	1	F5	1.0	286.0	17.8	66.6
CONTR.CONTINGENCY,LUN.SAM.RTN	G4016.	115	1	ISA(ON A3)	2.7	280.0	.0	-10.0
JETTISON BAG + ITEMS	B1027.	111	1	ISA(ON A3)	10.0	280.0	.0	-10.0
UPPER HOUSING ASSY,PENETROMETR	G4049.1	111	1	AIK	2.0	273.7	-20.0	-8.5
SAMPLE COLLECTION BAG 7	G4056.	111	1	LOWER BAY LHSSC	1.8	228.0	-40.2	43.2
BAG,SAMPLE CONTAINMENT	O3078.	111	1	LOWER BAY LHSSC	.5	228.0	-40.2	43.2
SAMPLES IN BAG 7	N/A	115	1	LOWER BAY LHSSC	15.0	228.0	-40.2	43.2
CONTAINER,SRC NO.1	G4003.	115	1	AIF	14.4	257.4	-20.7	-6.0
SAMPLE COLLECTION BAG 1	G4003.1	115	1	AIF	1.8	257.4	-20.7	-6.0
S.E.S. CONTAINER	G4003.2	115	1	AIF	.7	257.4	-20.7	-6.0
BAG,O.S.O.DISPENSER	G4003.3	115	2	AIF	2.2	257.4	-20.7	-6.0
DRILL STEMS+SAMPLES IN BAG 1	G4003.6	115	6	AIF	5.8	257.4	-20.7	-6.0
DRILL STEM CAPS	G4003.7	115	2	AIF	.2	257.4	-20.7	-6.0
ORGANIC SAMPLES	G4003.8	115	1	AIF	.2	257.4	-20.7	-6.0
SAMPLES IN BAG 1	N/A	115	1	AIF	14.9	257.4	-20.7	-6.0
CONTAINER,SRC NO.2	G4004.	115	1	AIE	14.4	265.9	-20.7	-6.0
SAMPLE COLLECTION BAG 5	G4004.1	115	1	AIE	1.8	265.9	-20.7	-6.0
S.E.S.CONTAINER	G4004.2	115	2	AIE	1.0	265.9	-20.7	-6.0

3.1-83

SNA-8-D-027(III) REV 3

U
N
I
T
E
D
S
T
A
T
E
S
O
F
A
S
T
A
S
T
R
O
N
A
U
T
I
C
S
A
D
S
P
A
C
E
S
H
I
P
S

TABLE 3.1-9.2 (CONTINUED)

MISSION J-1 TRANSFERRED CREW AND EQUIPMENT STOWAGE LIST								
ITEMS UNLOADED INTO ASC. STAGE PRIOR TO LUNAR LIFT-OFF (12)								
DESCRIPTION	STOW. ITEM	REF	NO.	STOWAGE LOCATION	WEIGHT	LM COORDINATES		
						X-C.G.	Y-C.G.	Z-C.G.
BAG O.S.B. DISPENSER	G4004.3	115	4	AIE	4.4	265.9	-20.7	-6.0
CORE TUBES+SAMPLES IN BAG 5	G4004.4	115	3	AIE	5.6	265.9	-20.7	-6.0
CAPS AND DISPENSER	G4004.5	115	2	AIE	.2	265.9	-20.7	-6.0
ORGANIC SAMPLE	G4004.6	115	1	AIE	.2	265.9	-20.7	-6.0
SAMPLES IN BAG 5	N/A	115	1	AIE	12.3	265.9	-20.7	-6.0
BAG, SAMPLE RETURN	03060.	115	1	ON PLUS 227 BULKHEAD	3.2	221.8	-1.0	29.5
SAMPLES IN 03060.	N/A	115	1	ON PLUS 227 BULKHEAD	26.3	221.8	-1.0	29.5
SAMPLE COLLECTION BAG 4	G4056.	115	1	LOWER BAY RHSSC	1.8	238.0	38.0	42.7
BAG, SAMPLE CONTAINMENT	03078.	115	1	LOWER BAY RHSSC	.5	238.0	38.0	42.7
SAMPLES IN BAG 4	N/A	115	1	LOWER BAY RHSSC	14.5	238.0	38.0	42.7
BAG, SAMPLE COLLECTION	03078.	111	1	LOWER MID-SECTION	.5	240.5	-18.0	13.3
SAMPLE COLLECTION BAG 3	G4048.	111	1	LOWER MID-SECTION	1.2	240.5	-18.0	13.3
SAMPLES IN BAG 3	N/A	115	1	LOWER MID-SECTION	8.5	240.5	-18.0	13.3
CORE TUBE+SAMPLES IN BAG 3	G4004.4	111	3	LOWER MID-SECTION	5.8	240.5	-18.0	13.3
SAMPLE COLLECTION BAG 8	G4048.	111	1	AFT ENG CAN(A14A)	1.2	239.6	-5.5	-14.8
SAMPLES IN BAG 8	N/A	115	1	AFT ENG CAN(A14A)	9.8	239.6	-5.5	-14.8
BAG, SAMPLE CONTAINMENT	03078.	111	1	AFT ENG CAN(A14A)	.5	239.6	-5.5	-14.8
CORE TUBE+SAMPLE IN BAG 8	G4003.4	111	1	AFT ENG CAN(A14A)	5.7	239.6	-5.5	-14.8
UNLOAD AT LUN. SITE					240.80	250.49	-7.43	9.54

3.1-84

SNA-8-D-027(III) REV 3

TABLE 3.1-9.2 (CONTINUED)

MISSION J-1 TRANSFERRED CREW AND EQUIPMENT STORAGE LIST								
ITEMS REARRANGED IN LM PRIOR TO LUNAR LIFT-OFF (13)								
DESCRIPTION	STOR. ITEM	REF	NO.	STORAGE LOCATION	WEIGHT	LM COORDINATES		
						X-C.G.	Y-C.G.	Z-C.G.
BAG, 16MM MAGAZINE XFR	06432.	111	1	CONTAINER A19A	.2	243.7	-5.5	-14.8
MAGAZINES, 16MM	A0101.2	111	2	CONTAINER A19A	2.0	243.7	-5.5	-14.8
MAGAZINE, L.S. HASSELBLAD	A0108.1	116	1	ON CAMERA (FYC)	1.4	242.8	38.0	41.0
MAGAZINE, 70MM LUNAR SURFACE	A0108.1	111	4	A1C	5.6	240.5	-18.0	13.3
MAGAZINE, 70MM LUNAR SURFACE	A0108.1	111	2	A1C	2.8	240.5	-18.0	13.3
OXYGEN PURGE SYSTEM	B1012.	115	1	A1E	35.9	245.9	-20.7	-6.0
BAG, HELMET STORAGE	B1058.	115	1	F8	1.4	221.0	18.0	51.0
BAG, HELMET STORAGE	B1058.	115	1	F10	1.4	221.0	-18.0	51.0
LUNAR EXTRAVEHICULAR VISOR	B1014.	115	1	F10	5.6	221.0	-18.0	51.0
LUNAR EXTRAVEHICULAR VISOR	B1014.	115	1	F8	5.6	221.0	18.0	51.0
GLOVES, EV-PAIR	B1015.	111	1	F8	2.9	221.0	18.0	51.0
GLOVES, EV-PAIR	B1015.	111	1	F8	2.9	221.0	18.0	51.0
KIT, EHU MAINTENANCE	B1016.	115	1	F10	.5	221.0	-18.0	51.0
PURGE VALVE ASSY.	B1017.	115	1	A1L	.6	281.0	-20.0	-8.5
PURGE VALVE ASSY.	B1017.	115	1	A1K	.6	273.7	-20.0	-8.5
HARNESS, WAIST	B1021.	115	1	F9	.2	219.9	-1.3	44.5
HARNESS, WAIST	B1021.	115	1	A1B	.2	243.5	-20.6	14.9
HARNESS, WAIST (ADJ.)	B1022.	115	1	F9	.3	219.9	-1.3	44.5
HARNESS, WAIST (ADJ.)	B1022.	115	1	A1B	.3	243.5	-20.6	14.9
GARMENT, LIQUID COOLING	B1030.	111	1	A1C	4.3	240.5	-18.0	13.3
GARMENT, LIQUID COOLING	B1030.	111	1	A1C	4.3	240.5	-18.0	13.3
DEVICE, IN-SUIT DRINKING	B1048.	111	1	F6B	.3	270.3	.0	52.8
DEVICE, IN-SUIT DRINKING	B1048.	111	1	F6B	.3	270.3	.0	52.8
OXYGEN PURGE SYSTEM (OPS)	B1059.	111	1	A1F	35.9	257.4	-20.7	-6.0
BAG, EQUIPMENT TRANSFER	03018.	111	1	A5	1.2	221.8	-1.0	29.5
BAG, TEMPORARY STORAGE	03031.	111	1	F6B	.9	270.3	.0	52.8
BAG, 70MM MAGAZINE XFR	06466.	111	1	CONTAINER A19A	.3	243.7	-5.5	-14.8
BAG, 70MM MAGAZINE XFR	06466.	111	1	CONTAINER A19A	.3	243.7	-5.5	-14.8
BAG, ANCILLARY STORAGE	T0100.	111	1	F1K	1.5	237.8	-37.8	31.5
LM EQUIP. RELOC. 2					119.70	250.51	-14.64	8.59

3.1-85

SNA-8-D-027(111) REV 3

TABLE 3.1-9.2 (CONTINUED)

MISSION J-1 TRANSFERRED CREW AND EQUIPMENT STOWAGE LIST								
ITEMS REARRANGED IN LM PRIOR TO LUNAR LIFT-OFF (14)								
DESCRIPTION	STOW. ITEM	REF	NO.	STOWAGE LOCATION	WEIGHT	LM COORDINATES		
						X-C.G.	Y-C.G.	Z-C.G.
BAG, 16MM MAGAZINE XFR	06432.	111	1	A1K	.2	273.7	-20.0	-8.5
MAGAZINES, 16MM	A0101.2	111	2	A1K	2.0	273.7	-20.0	-8.5
MAGAZINE, L.S. HASSELBLAD	A0108.1	116	1	IN XFR BAG(F7D)	1.4	238.0	38.0	38.4
MAGAZINE, 70MM LUNAR SURFACE	A0108.1	111	4	A1K	5.6	273.7	-20.0	-8.5
MAGAZINE, 70MM LUNAR SURFACE	A0108.1	111	2	A1K	2.8	273.7	-20.0	-8.5
OXYGEN PURGE SYSTEM	B1012.	115	1	F9	35.9	219.9	-1.3	44.5
BAG, HELMET STOWAGE	B1058.	115	1	A3	1.4	280.0	.0	-10.0
BAG, HELMET STOWAGE	B1058.	115	1	A3	1.4	280.0	.0	-10.0
LUNAR EXTRAVEHICULAR VISOR	B1014.	115	1	IN HSB(A3)	5.6	280.0	.0	-10.0
LUNAR EXTRAVEHICULAR VISOR	B1014.	115	1	IN HSB(A3)	5.6	280.0	.0	-10.0
GLOVES, EV-PAIR	B1015.	111	1	IN HSB(A3)	2.9	280.0	.0	-10.0
GLOVES, EV-PAIR	B1015.	111	1	IN HSB(A3)	2.9	280.0	.0	-10.0
KIT, EMU MAINTENANCE	B1016.	115	1	IN HSB(A3)	.5	280.0	.0	-10.0
PURGE VALVE ASSY.	B1017.	115	1	F7P	.6	241.0	38.0	53.4
PURGE VALVE ASSY.	B1017.	115	1	F7P	.6	241.0	38.0	53.4
HARNESS, WAIST	B1021.	115	1	F7P	.2	241.0	38.0	53.4
HARNESS, WAIST	B1021.	115	1	F7P	.2	241.0	38.0	53.4
HARNESS, WAIST (ADJ.)	B1022.	115	1	F7P	.3	241.0	38.0	53.4
HARNESS, WAIST (ADJ.)	B1022.	115	1	F7P	.3	241.0	38.0	53.4
GARMENT, LIQUID COOLING	B1030.	111	1	ON CREW(RH CREW STA)	4.3	252.0	22.0	38.0
GARMENT, LIQUID COOLING	B1030.	111	1	ON CREW(LH CREW STA)	4.3	252.0	-22.0	44.0
DEVICE, IN-SUIT DRINKING	B1048.	111	1	ON CREW(RH CREW STA)	.3	252.0	22.0	38.0
DEVICE, IN-SUIT DRINKING	B1048.	111	1	ON CREW(LH CREW STA)	.3	252.0	-22.0	44.0
OXYGEN PURGE SYSTEM (OPS)	B1059.	111	1	F9	35.9	219.9	-1.3	44.5
BAG, EQUIPMENT TRANSFER	03018.	111	1	15A(ON A3)	1.2	280.0	.0	-10.0
BAG, TEMPORARY STOWAGE	03031.	111	1	A3	.9	280.0	.0	-10.0
BAG, 70MM MAGAZINE XFR	06466.	111	1	A1K	.3	273.7	-20.0	-8.5
BAG, 70MM MAGAZINE XFR	06466.	111	1	A1K	.3	273.7	-20.0	-8.5
BAG, ANCILLARY STOWAGE	T0100.	111	1	A1G	1.5	257.5	-20.0	-18.0
LM EQUIP. RELOC. 2					119.70	239.72	-1.76	28.38

3.1-86

SNA-8-D-027(III) REV 3

U
N
I
T
E
D
S
T
A
T
E
S
O
F
A
S
T
E
R
N
H
E
M
I
S
P
H
E
R
E
S
P
A
C
E
A
G
E
N
C
Y

U
 N
 I
 T
 E
 D
 S
 T
 A
 T
 E
 S
 U
 R
 E
 S
 T
 A
 N
 C
 E
 R
 E
 C
 O
 R
 D
 S
 U
 N
 D
 E
 R
 T
 H
 E
 A
 S
 T
 R
 O
 N
 O
 M
 I
 C
 A
 L
 S
 Y
 S
 T
 E
 M

TABLE 3.1-9.2 (CONTINUED)

MISSION J-1 TRANSFERRED CREW AND EQUIPMENT STOWAGE LIST								
ITEMS TRANSFERRED FROM ASC. STAGE INTO CM PRIOR TO ASC. STAGE JETTISON (15)								
LM COORDINATES								
DESCRIPTION	STOW. ITEM	REF	NO.	STOWAGE LOCATION	WEIGHT	X-C.G.	Y-C.G.	Z-C.G.
CREW-COMMANDER (CDR)	N/A	227	1	CREW STATION - LM	183.5	252.0	-22.0	49.0
CREW-LM PILOT (LMP)	N/A	227	1	CREW STATION - RH	163.0	252.0	22.0	38.0
INTERIM STOWAGE ASSY.	03007.	111	• 1	A3	6.4	280.0	.0	-10.0
EXP, SOLAR WIND COMPOSITION	G4011.	111	1	15A (ON A3)	.2	280.0	.0	-10.0
BAG, SAMPLE CONTAINER	03078.	111	2	15A (ON A3)	1.0	280.0	.0	-10.0
SAMPLE COLLECTION BAG 2 AND 6	G4048.	115	2	15A (ON A3)	2.4	280.0	.0	-10.0
SAMPLES IN BAGS 2 AND 6	N/A	115	2	15A (ON A3)	17.2	280.0	.0	-10.0
BAG, SWC EXPERIMENT - STOWAGE	G4055.	111	1	15A (ON A3)	.2	280.0	.0	-10.0
BAG, XFR, 16MM MAGAZINE	06397.	111	1	F7L	.3	231.8	36.0	47.3
BAG, XFR, 70MM MAGAZINE	06398.	111	2	F7D	.8	238.0	38.0	38.4
BAG, TRANSFER-16MM MAG. (2)	06432.	111	• 1	15A (ON A3)	.1	280.0	.0	-10.0
BAG, TRANSFER-70MM MAG (3)	06434.	111	• 1	F7P	.5	241.0	38.0	53.4
BAG, 16MM MAGAZINE XFR	06432.	111	1	A1K	.2	273.7	-20.0	-8.5
MAGAZINES, 16MM	A0101.2	111	2	A1K	2.0	273.7	-20.0	-8.5
MAGAZINE, 16MM DATA ACQ.	A0101.1	116	5	IN XFR BAG (F7L)	5.0	231.8	36.0	47.3
MAGAZINE, 16MM DATA ACQ.	A0101.1	116	2	15A (ON A3)	2.0	280.0	.0	-10.0
MAGAZINE, 16MM DATA ACQ.	A0101.1	116	1	ON CAMERA (FS)	1.0	286.0	17.8	66.6
MAGAZINE, L.S. HASSELBLAD	A0108.1	116	3	IN XFR BAG (F7D)	4.2	238.0	38.0	38.4
MAGAZINE, L.S. HASSELBLAD	A0108.1	116	1	IN XFR BAG (F7O)	1.4	238.0	38.0	38.4
MAGAZINE, L.S. HASSELBLAD	A0108.1	116	3	IN XFR BAG (F7P)	4.2	241.0	38.0	53.4
DOSIMETER, PASSIVE RADIATION	D0101.	111	1	IN XFR BAG (F7L)	NEGL	231.8	36.0	47.3
LM XFR DATA CARD KIT	A0114.18	114	1	A1A	.6	280.0	-19.0	13.5
LM LUNAR SURFACE CHECKLIST	A0114.10	114	1	LM XFR DATA CARD KIT	1.0	280.0	-19.0	13.5
LM SYSTEMS ACTIVATION CHK. LST.	A0114.12	114	1	LM XFR DATA CARD KIT	.5	280.0	-19.0	13.5
LM SYSTEMS ACTIVATION CHK. LST.	A0114.12	114	1	LM XFR DATA CARD KIT	.5	280.0	-19.0	13.5
LM LUNAR SURFACE MAPS	A0114.13	114	1	LM XFR DATA CARD KIT	1.5	280.0	-19.0	13.5
LM TIMELINE BOOK	A0114.14	114	1	LM XFR DATA CARD KIT	.5	280.0	-19.0	13.5
LM DATA CARD BOOK	A0114.19	114	1	LM XFR DATA CARD KIT	.3	280.0	-19.0	13.5
LM RNDZ/ABORT BOOK	A0114.22	114	1	LM XFR DATA CARD KIT	.3	280.0	-19.0	13.5
MONOCULAR 10X40	A0130.	116	1	F7R	.7	238.4	38.6	46.0
SUNGLASSES	A0200.	111	1	ON CREW (LM CREW STA)	.1	252.0	-22.0	49.0
SUNGLASSES	A0200.	111	1	ON CREW (RH CREW STA)	.1	252.0	22.0	38.0

3.1-87

SNA-8-D-027 (III) REV 3

TABLE 3.1-9.2 (CONTINUED)

MISSION J-1 TRANSFERRED CREW AND EQUIPMENT STORAGE LIST								
ITEMS TRANSFERRED FROM ASC. STAGE INTO CM PRIOR TO ASC. STAGE JETTISON (15)								
LM COORDINATES								
DESCRIPTION	STOW. ITEM	REF	NO.	STORAGE LOCATION	WEIGHT	X-C.G.	Y-C.G.	Z-C.G.
POUCH, SUNGLASSES	A0201.	111	1	ON CREW(LH CREW STA)	NEGL	252.0	-22.0	44.0
POUCH, SUNGLASSES	A0201.	111	1	ON CREW(RH CREW STA)	NEGL	252.0	22.0	38.0
CHRONOGRAPH - 002	A0202.	111	1	ON CREW(LH CREW STA)	.1	252.0	-22.0	44.0
CHRONOGRAPH - 002	A0202.	111	1	ON CREW(RH CREW STA)	.1	252.0	22.0	38.0
WATCHBAND	A0203.	111	1	ON CREW(LH CREW STA)	NEGL	252.0	-22.0	44.0
WATCHBAND	A0203.	111	1	ON CREW(RH CREW STA)	NEGL	252.0	22.0	38.0
PENS, DATA RECORDING	A0204.	111	1	ON CREW(LH CREW STA)	.1	252.0	-22.0	44.0
PENS, DATA RECORDING	A0204.	111	1	ON CREW(RH CREW STA)	.1	252.0	22.0	38.0
PEN, MARKER	A0205.	111	1	ON CREW(LH CREW STA)	NEGL	252.0	-22.0	44.0
PEN, MARKER	A0205.	111	1	ON CREW(RH CREW STA)	NEGL	252.0	22.0	38.0
PENCIL	A0206.	111	1	ON CREW(LH CREW STA)	.1	252.0	-22.0	44.0
PENCIL	A0206.	111	1	ON CREW(RH CREW STA)	.1	252.0	22.0	38.0
KIT, PILOTS PREFERENCE	A1007.	111	2	A1H	1.8	265.9	-20.0	-18.0
KIT, PILOTS PREFERENCE	A1007.	111	1	A1H	.9	265.9	-20.0	-18.0
MAGAZINE, 70MM LUNAR SURFACE	A0108.1	111	4	A1K	5.6	273.7	-20.0	-8.5
MAGAZINE, 70MM LUNAR SURFACE	A0108.1	111	2	A1K	2.8	273.7	-20.0	-8.5
SUBSYSTEM, FECAL CONTAINMENT	B0113.	111	.01	ON CREW(LH CREW STA)	.3	252.0	-22.0	44.0
SUBSYSTEM, FECAL CONTAINMENT	B0113.	111	.01	ON CREW(RH CREW STA)	.3	252.0	22.0	38.0
HARNESS, CW6 ELECTRICAL (CDR)	B0135.	111	1	F1E	.4	237.9	-33.6	55.0
HARNESS, CW6 ELECTRICAL (LMP)	B0135.	111	1	F1E	.4	237.9	-33.6	55.0
SCISSORS	B0204.	111	1	ON CREW(RH CREW STA)	.5	252.0	22.0	38.0
UCTA	B0205.	111	1	ON CREW(RH CREW STA)	.5	252.0	22.0	38.0
UCTA	B0205.	111	1	ON CREW(LH CREW STA)	.5	252.0	-22.0	44.0
PENLIGHTS	B0206.	111	1	ON CREW(LH CREW STA)	.3	252.0	-22.0	44.0
PENLIGHTS	B0206.	111	1	ON CREW(RH CREW STA)	.3	252.0	22.0	38.0
BIOBELT ASSY	B0207.	111	1	ON CREW(LH CREW STA)	.2	252.0	-22.0	44.0
BIOBELT ASSY	B0207.	111	1	ON CREW(RH CREW STA)	.2	252.0	22.0	38.0
ITLSA - EV	B0211.	111		ON CREW(RH CREW STA)	46.9	252.0	22.0	38.0
ITLSA - EV	B0211.	111		ON CREW(LH CREW STA)	46.9	252.0	-22.0	44.0
GLOVES, IV PAIR	B0213.	111	1	ON CREW(RH CREW STA)	2.0	252.0	22.0	38.0
GLOVES, IV PAIR	B0213.	111	1	ON CREW(LH CREW STA)	2.0	252.0	-22.0	44.0
HELMET ASSY, PRESSURE	B0214.	111	1	ON CREW(RH CREW STA)	2.6	252.0	22.0	38.0

3.1-88

SNA-8-D-027(III) REV 3

TABLE 3.1-9.2 (CONTINUED)

MISSION J-1 TRANSFERRED CREW AND EQUIPMENT STORAGE LIST								
ITEMS TRANSFERRED FROM ASC. STAGE INTO CM PRIOR TO ASC. STAGE JETTISON (15)								
LM COORDINATES								
DESCRIPTION	STOW. ITEM	REF	NO.	STORAGE LOCATION	WEIGHT	X-C.G.	Y-C.G.	Z-C.G.
HELMET ASSY, PRESSURE	B0214.	111	1	ON CREW(LH CREW STA)	2.6	252.0	-22.0	44.0
HARNESS,ELEC - SUIT	B0224.	111	1	ON CREW(RH CREW STA)	.5	252.0	22.0	30.0
HARNESS,ELEC - SUIT	B0224.	111	1	ON CREW(LH CREW STA)	.5	252.0	-22.0	44.0
HARNESS, BIOINSTRUMENTATION	B0216.	111	1	ON CREW(RH CREW STA)	.3	252.0	22.0	30.0
HARNESS, BIOINSTRUMENTATION	B0216.	111	1	ON CREW(LH CREW STA)	.3	252.0	-22.0	44.0
COMMUNICATION CARRIER	B0217.	111	1	ON CREW(RH CREW STA)	1.6	252.0	22.0	30.0
COMMUNICATION CARRIER	B0217.	111	1	ON CREW(LH CREW STA)	1.6	252.0	-22.0	44.0
POCKET,SCISSORS (COR)	B0218.	111	1	ON CREW(LH CREW STA)	.2	252.0	-22.0	44.0
POCKET,SCISSORS (LMP)	B0218.	111	1	ON CREW(RH CREW STA)	.2	252.0	22.0	30.0
POCKET,CHECKLIST (CDR)	B0219.	111	1	ON CREW(LH CREW STA)	.2	252.0	-22.0	44.0
POCKET,CHECKLIST (LMP)	B0219.	111	1	ON CREW(RH CREW STA)	.2	252.0	22.0	30.0
POCKET,DATA(CDR)	B0220.	111	1	ON CREW(LH CREW STA)	.2	252.0	-22.0	44.0
POCKET,DATA(LMP)	B0220.	111	1	ON CREW(RH CREW STA)	.2	252.0	22.0	30.0
OXYGEN PURGE SYSTEM	B1012.	115	1	F9	35.9	219.9	-1.3	44.5
BAG, HELMET STORAGE	B1050.	115	1	A3	1.4	200.0	.0	-10.0
BAG, HELMET STORAGE	B1050.	115	1	A3	1.4	200.0	.0	-10.0
LUNAR EXTRAVEHICULAR VISOR	B1014.	115	1	IN HSB(A3)	5.6	200.0	.0	-10.0
LUNAR EXTRAVEHICULAR VISOR	B1014.	115	1	IN HSB(A3)	5.6	200.0	.0	-10.0
GLOVES,EV-PAIR	B1015.	111	1	IN HSB(A3)	2.9	200.0	.0	-10.0
GLOVES,EV-PAIR	B1015.	111	1	IN HSB(A3)	2.9	200.0	.0	-10.0
KIT,EMU MAINTENANCE	B1016.	115	1	IN HSB(A3)	.5	200.0	.0	-10.0
PURGE VALVE ASSY.	B1017.	115	1	F7P	.6	241.0	30.0	53.4
TETHER, WAIST EVA	B1020.6	115	1	F7N	.6	230.0	30.0	53.1
TETHER, WAIST EVA	B1020.7	115	1	F7N	.6	230.0	30.0	53.1
GARMENT,LIQUID COOLING	B1030.	111	1	ON CREW(RH CREW STA)	4.3	252.0	22.0	30.0
GARMENT,LIQUID COOLING	B1030.	111	1	ON CREW(LH CREW STA)	4.3	252.0	-22.0	44.0
DEVICE,IN-SUIT DRINKING	B1048.	111	1	ON CREW(RH CREW STA)	.3	252.0	22.0	30.0
DEVICE,IN-SUIT DRINKING	B1048.	111	1	ON CREW(LH CREW STA)	.3	252.0	-22.0	44.0
ASSY,BIOINSTRUMENTATION	C0201.	111	1	ON CREW(LH CREW STA)	1.1	252.0	-22.0	44.0
ASSY,BIOINSTRUMENTATION	C0201.	111	1	ON CREW(RH CREW STA)	1.1	252.0	22.0	30.0
DOSIMETER,PERSONAL	D0200.	117	1	ON CREW(RH CREW STA)	.4	252.0	22.0	30.0
DOSIMETER,PERSONAL	D0200.	117	1	ON CREW(LH CREW STA)	.4	252.0	-22.0	44.0

3.1-89

SNA-8-D-027(III) REV 3

TABLE 3.1-9.2 (CONTINUED)

MISSION J-1 TRANSFERRED CREW AND EQUIPMENT STORAGE LIST								
ITEMS TRANSFERRED FROM ASC. STAGE INTO CM PRIOR TO ASC. STAGE JETTISON (15)								
LM COORDINATES								
DESCRIPTION	STOW. ITEM	REF	NO.	STOWAGE LOCATION	WEIGHT	X-C.G.	Y-C.G.	Z-C.G.
DOSIMETER, PASSIVE	00201.	117	3	ON CREW(RH CREW STA)	NEGL	252.0	22.0	38.0
DOSIMETER, PASSIVE	00201.	117	3	ON CREW(LH CREW STA)	NEGL	252.0	-22.0	44.0
HEADSET, LIGHTWEIGHT	E0111.	111	1	FIB	.4	235.5	-35.5	38.5
HEADSET, LIGHTWEIGHT	E0112.	111	1	FIB	.4	235.5	-35.5	38.5
EARPIECE, MOULDED (COMM. CARRIER)	E0200.1	111	1	ON CREW(RH CREW STA)	NEGL	252.0	22.0	38.0
EARPIECE, MOULDED (COMM. CARRIER)	E0200.1	111	1	ON CREW(LH CREW STA)	NEGL	252.0	-22.0	44.0
EARTUBE (COMM. CARRIER)	E0200.2	111	2	ON CREW(RH CREW STA)	NEGL	252.0	22.0	38.0
EARTUBE (COMM. CARRIER)	E0200.2	111	2	ON CREW(LH CREW STA)	NEGL	252.0	-22.0	44.0
CONTR. CONTINGENCY, LUN. SAM. RTN	G4016.	115	1	ISA (ON A3)	2.7	280.0	.0	-10.0
JETTISON BAG + ITEMS	B1027.	111	1	ISA (ON A3)	10.0	280.0	.0	-10.0
FLAG KIT, STANDARD	N1002.	166	1	A1H	.8	265.9	-20.0	-18.0
DSEA	O3005.	115	1	A2	2.3	260.0	-37.0	28.0
BAG, EQUIPMENT TRANSFER	O3018.	111	1	ISA (ON A3)	1.2	280.0	.0	-10.0
UPPER HOUSING ASSY, PENETROMETR	G4049.1	111	1	A1K	2.0	273.7	-20.0	-8.5
SAMPLE COLLECTION BAG 7	G4056.	111	1	LOWER BAY LHSSC	1.8	228.0	-40.2	43.2
BAG, SAMPLE CONTAINMENT	O3078.	111	1	LOWER BAY LHSSC	.5	228.0	-40.2	43.2
SAMPLES IN BAG 7	N/A	115	1	LOWER BAY LHSSC	15.0	228.0	-40.2	43.2
CONTAINER, SRC NO.1	G4003.	115	1	A1F	14.4	257.4	-20.7	-6.0
SAMPLE COLLECTION BAG 1	G4003.1	115	1	A1F	1.8	257.4	-20.7	-6.0
S.E.S. CONTAINER	G4003.2	115	1	A1F	.7	257.4	-20.7	-6.0
BAG D.S.B. DISPENSER	G4003.3	115	2	A1F	2.2	257.4	-20.7	-6.0
DRILL STEMS+SAMPLES IN BAG 1	G4003.6	115	6	A1F	5.8	257.4	-20.7	-6.0
DRILL STEM CAPS	G4003.7	115	2	A1F	.2	257.4	-20.7	-6.0
ORGANIC SAMPLES	G4003.8	115	1	A1F	.2	257.4	-20.7	-6.0
SAMPLES IN BAG 1	N/A	115	1	A1F	14.9	257.4	-20.7	-6.0
CONTAINER, SRC NO.2	G4004.	115	1	A1E	14.4	265.9	-20.7	-6.0
SAMPLE COLLECTION BAG 5	G4004.1	115	1	A1E	1.8	265.9	-20.7	-6.0
S.E.S. CONTAINER	G4004.2	115	2	A1E	1.0	265.9	-20.7	-6.0
BAG D.S.B. DISPENSER	G4004.3	115	4	A1E	4.4	265.9	-20.7	-6.0
CORE TUBES+SAMPLES IN BAG 5	G4004.4	115	3	A1E	5.6	265.9	-20.7	-6.0
CAPS AND DISPENSER	G4004.5	115	2	A1E	.2	265.9	-20.7	-6.0
ORGANIC SAMPLE	G4004.6	115	1	A1E	.2	265.9	-20.7	-6.0

3.1-90

SNA-8-D-027(111) REV 3

U
S
N
A
V
Y
A
I
R
F
O
R
C
E

3.1-91

SMA-8-D-027(III) REV 3

Amendment 110
7/19/71

TABLE 3.1-9.2 (CONTINUED)

MISSION J-1 TRANSFERRED CREW AND EQUIPMENT STORAGE LIST								
ITEMS TRANSFERRED FROM ASC. STAGE INTO CM PRIOR TO ASC. STAGE JETTISON (15)								
LM COORDINATES								
DESCRIPTION	STOW. ITEM	REF	NO.	STOWAGE LOCATION	WEIGHT	X-C.G.	Y-C.G.	Z-C.G.
SAMPLES IN BAG 5	N/A	115	1	AIE	12.3	265.9	-20.7	-6.0
BAG, SAMPLE RETURN	03060.	115	1	ON PLUS 227 BULKHEAD	3.7	221.8	-1.0	29.5
SAMPLES IN 03060.	N/A	115	1	ON PLUS 227 BULKHEAD	26.3	221.8	-1.0	29.5
SAMPLE COLLECTION BAG 4	G4056.	115	1	LOWER BAY RHSSC	1.8	238.0	38.0	42.7
BAG, SAMPLE CONTAINMENT	03078.	115	1	LOWER BAY RHSSC	.5	238.0	38.0	42.7
SAMPLES IN BAG 4	N/A	115	1	LOWER BAY RHSSC	14.5	238.0	38.0	42.7
BAG, SAMPLE COLLECTION	03078.	111	1	LOWER MID-SECTION	.5	240.5	-18.0	13.3
SAMPLE COLLECTION BAG 3	G4048.	111	1	LOWER MID-SECTION	1.2	240.5	-18.0	13.3
SAMPLES IN BAG 3	N/A	115	1	LOWER MID-SECTION	8.5	240.5	-18.0	13.3
CORE TUBE+SAMPLES IN BAG 3	G4004.4	111	3	LOWER MID-SECTION	5.8	240.5	-18.0	13.3
SAMPLE COLLECTION BAG 8	G4048.	111	1	AFT ENG CAN(A14A)	1.2	239.6	-5.5	-14.8
SAMPLES IN BAG 8	N/A	115	1	AFT ENG CAN(A14A)	9.8	239.6	-5.5	-14.8
BAG, SAMPLE CONTAINMENT	03078.	111	1	AFT ENG CAN(A14A)	.5	239.6	-5.5	-14.8
CONTAINER, CORE TUBE	03074.	111	1	AFT ENG CAN(A14A)	1.3	239.6	-5.5	-14.8
CORE TUBE+SAMPLE IN BAG 8	G4003.4	111	1	AFT ENG CAN(A14A)	5.7	239.6	-5.5	-14.8
BAG, 70MM MAGAZINE XFR	06466.	111	1	AIK	.3	273.7	-20.0	-8.5
BAG, 70MM MAGAZINE XFR	06466.	111	1	AIK	.3	273.7	-20.0	-8.5
BAG, ANCILLARY STOWAGE	T0100.	111	1	AI6	1.5	257.5	-20.0	-18.0
UTILITY STRAP	06315.	111	3	FIG	.1	228.0	-40.2	43.2
INFLIGHT RETAINER STRAPS	00360.	111	4	FIG	.1	228.0	-40.2	43.2
2 CREW+EQUIP, LM-CM					796.81	251.60	-3.15	29.00

TABLE 3.1-9.2 (CONTINUED)

MISSION J-1 TRANSFERRED CREW AND EQUIPMENT STORAGE LIST								
ITEMS TRANSFERRED FROM ASC, STAGE INTO CM PRIOR TO ASC, STAGE JETTISON (16)								
APOLLO COORDINATES								
DESCRIPTION	STOW. ITEM	REF	NO.	STORAGE LOCATION	WEIGHT	X-C.G.	Y-C.G.	Z-C.G.
CREW-COMMANDER (CDR)	N/A	227	1	ON COUCH (CTR CREW STA	183.5	1043.0	.0	-10.4
CREW-LM PILOT (LMP)	N/A	227	1	ON COUCH (RH CREW STA	163.0	1043.0	24.5	-10.4
INTERIM STOWAGE ASSY.	03007.	111	• 1	AREA A2	6.4	1011.0	-22.0	8.0
EXP, SOLAR WIND COMPOSITION	G4911.	111	1	ISA (A2)	.2	1019.0	-22.0	8.0
BAG, SAMPLE CONTAINER	03078.	111	2	ISA (A2)	1.0	1019.0	-22.0	8.0
SAMPLE COLLECTION BAG 2 AND 6	G404A.	115	2	ISA (A2)	2.4	1019.0	-22.0	8.0
SAMPLES IN BAGS 2 AND 6	N/A	115	2	ISA (A2)	17.2	1019.0	-22.0	8.0
BAG, SWC EXPERIMENT - STOWAGE	G4955.	111	1	ISA (A2)	.2	1019.0	-22.0	8.0
BAG, XFER, 16MM MAGAZINE	06397.	111	1	AREA R13	.3	1024.0	45.0	-26.0
BAG, XFER, 70MM MAGAZINE	06398.	111	2	AREA R13	.8	1024.0	45.0	-26.0
BAG, TRANSFER-16MM MAG. (2)	06432.	111	• 1	AREA R13	.1	1024.0	45.0	-26.0
BAG, TRANSFER-70MM MAG (3)	06434.	111	• 1	AREA R13	.5	1024.0	45.0	-26.0
BAG, 16MM MAGAZINE XFR	06432.	111	1	AREA R13	.2	1024.0	45.0	-26.0
MAGAZINES, 16MM	A0101.2	111	2	IN XFR BAG (R13)	2.0	1024.0	45.0	-26.0
MAGAZINE, 16MM DATA ACQ.	A0101.1	116	5	IN XFR BAG (R13)	5.0	1024.0	45.0	-26.0
MAGAZINE, 16MM DATA ACQ.	A0101.1	116	2	IN XFR BAG (R13)	2.0	1024.0	45.0	-26.0
MAGAZINE, 16MM DATA ACQ.	A0101.1	116	1	IN XFR BAG (R13)	1.0	1024.0	45.0	-26.0
MAGAZINE, L.S. HASSELBLAD	A0108.1	116	3	IN XFR BAG (R13)	4.2	1024.0	45.0	-26.0
MAGAZINE, L.S. HASSELBLAD	A0108.1	116	1	IN XFR BAG (R13)	1.4	1024.0	45.0	-26.0
MAGAZINE, L.S. HASSELBLAD	A0108.1	116	3	IN XFR BAG (R13)	4.2	1024.0	45.0	-26.0
DOSIMETER, PASSIVE RADIATION	DD101.	111	1	IN XFR BAG (R13)	NEGL	1024.0	45.0	-26.0
LM XFR DATA CARD KIT	A0114.18	114	1	AREA R3	.6	1072.0	26.0	9.0
LM LUNAR SURFACE CHECKLIST	A0114.10	114	1	IN FDF (R3)	1.0	1072.0	26.0	9.0
LM SYSTEMS ACTIVATION CHK. LST.	A0114.12	114	1	IN FDF (R3)	.5	1072.0	26.0	9.0
LM SYSTEMS ACTIVATION CHK. LST.	A0114.12	114	1	IN FDF (R3)	.5	1072.0	26.0	9.0
LM LUNAR SURFACE MAPS	A0114.13	114	1	IN FDF (R3)	1.5	1072.0	26.0	9.0
LM TIMELINE BOOK	A0114.14	114	1	IN FDF (R3)	.5	1072.0	26.0	9.0
LM DATA CARD BOOK	A0114.19	114	1	IN FDF (R3)	.3	1072.0	26.0	9.0
LM RNDZ/ABORT BOOK	A0114.22	114	1	IN FDF (R3)	.3	1072.0	26.0	9.0
MONOCULAR 10X40	A0136.	116	1	AREA U4	.7	1038.0	39.0	-43.0
SUNGLASSES	A0200.	111	1	ON CREW	.1	1042.8	-7.6	-20.7
SUNGLASSES	A0200.	111	1	ON CREW	.1	1042.8	-7.6	-20.7

3.1-92

SNA-8-D-027(III) REV 3

U
S
N
A
S
P
A
C
E
A
G
E
N
C
Y

TABLE 3.1-9.2 (CONTINUED)

MISSION J-1 TRANSFERRED CREW AND EQUIPMENT STORAGE LIST								
ITEMS TRANSFERRED FROM ASC. STAGE INTO CM PRIOR TO ASC. STAGE JETTISON (16)								
APOLLO COORDINATES								
DESCRIPTION	STOW. ITEM	REF	NO.	STOWAGE LOCATION	WEIGHT	X-C.G.	Y-C.G.	Z-C.G.
POUCH, SUNGLASSES	A0201.	111	1	ON CREW	NEGL	1042.8	-7.6	-20.7
POUCH, SUNGLASSES	A0201.	111	1	ON CREW	NEGL	1042.8	-7.6	-20.7
CHRONOGRAPH - 002	A0202.	111	1	ON CREW	.1	1050.0	.0	-14.9
CHRONOGRAPH - 002	A0202.	111	1	ON CREW	.1	1050.0	.0	-14.9
WATCHBAND	A0203.	111	1	ON CREW	NEGL	1050.0	.0	-14.9
WATCHBAND	A0203.	111	1	ON CREW	NEGL	1050.0	.0	-14.9
PENS, DATA RECORDING	A0204.	111	1	ON CREW	.1	1042.8	12.5	-20.7
PENS, DATA RECORDING	A0204.	111	1	ON CREW	.1	1042.8	12.5	-20.7
PEN, MARKER	A0205.	111	1	ON CREW	NEGL	1042.8	12.5	-20.7
PEN, MARKER	A0205.	111	1	ON CREW	NEGL	1042.8	12.5	-20.7
PENCIL	A0206.	111	1	ON CREW	.1	1042.8	12.5	-20.7
PENCIL	A0206.	111	1	ON CREW	.1	1042.8	12.5	-20.7
KIT, PILOTS PREFERENCE	A1007.	111	2	AREA AB	1.8	1011.0	21.0	-23.0
KIT, PILOTS PREFERENCE	A1007.	111	1	AREA AB	.9	1011.0	21.0	-23.0
MAGAZINE, 70MM LUNAR SURFACE	A0108.1	111	4	IN XFR BAG (A8)	5.6	1011.0	21.0	-23.0
MAGAZINE, 70MM LUNAR SURFACE	A0108.1	111	2	IN XFR BAG (A8)	2.8	1011.0	21.0	-23.0
SUBSYSTEM, FECAL CONTAINMENT	R0113.	111	.01	ON CREW RH STA	.3	1043.0	24.5	-11.9
SUBSYSTEM, FECAL CONTAINMENT	R0113.	111	.01	ON CREW CTR STA	.3	1043.0	.0	-11.9
HARNESS, CWG ELECTRICAL (CDR)	R0135.	111	1	IN ADAPTER BAG (A8)	.4	1011.0	21.0	-23.0
HARNESS, CWG ELECTRICAL (LMP)	R0135.	111	1	IN ADAPTER BAG (A8)	.4	1011.0	21.0	-23.0
SCISSORS	R0204.	111	1	ON CREW	.5	1047.2	.0	-23.4
UCTA	R0205.	111	1	ON CREW	.5	1043.0	.0	-5.9
UCTA	R0205.	111	1	ON CREW	.5	1043.0	.0	-5.9
PENLIGHTS	R0206.	111	1	ON CREW	.3	1042.8	-7.6	-20.7
PENLIGHTS	R0206.	111	1	ON CREW	.3	1042.8	-7.6	-20.7
BIOBELT ASSY	R0207.	111	1	ON CREW	.2	1041.0	.0	-12.9
BIOBELT ASSY	R0207.	111	1	ON CREW	.2	1041.0	.0	-12.9
ITLSA - EV	R0211.	111		ON CREW RH STA	46.9	1043.0	24.5	-11.9
ITLSA - EV	R0211.	111		ON CREW CTR STA	46.9	1043.0	.0	-11.9
GLOVES, IV PAIR	R0213.	111	1	ON CREW RH STA	2.0	1043.0	24.5	-11.9
GLOVES, IV PAIR	R0213.	111	1	ON CREW CTR STA	2.0	1043.0	.0	-11.9
HELMET ASSY, PRESSURE	R0214.	111	1	ON CREW RH STA	2.6	1043.0	24.5	-11.9

3.1-93

SNA-8-D-027(III) REV 3

TABLE 3.1-9.2 (CONTINUED)

MISSION J-1 TRANSFERRED CREW AND EQUIPMENT STORAGE LIST								
ITEMS TRANSFERRED FROM ASC. STAGE INTO CM PRIOR TO ASC. STAGE JETTISON (16)								
APOLLO COORDINATES								
DESCRIPTION	STOW. ITEM	REF	NO.	STOWAGE LOCATION	WEIGHT	X-C.G.	Y-C.G.	Z-C.G.
HELMET ASSY, PRESSURE	B0214.	111	1	ON CREW CTR STA	2.6	1043.0	.0	-11.9
HARNESS,ELEC - SUIT	B0224.	111	1	ON CREW CTR STA	.5	1043.0	.0	-11.9
HARNESS,ELEC - SUIT	B0224.	111	1	ON CREW RH STA	.5	1043.0	24.5	-11.9
HARNESS, BIOINSTRUMENTATION	B0216.	111	1	ON CREW CTR STA	.3	1043.0	.0	-11.9
HARNESS, BIOINSTRUMENTATION	B0216.	111	1	ON CREW RH STA	.3	1043.0	24.5	-11.9
COMMUNICATION CARRIER	B0217.	111	1	ON CREW RH STA	1.6	1043.0	24.5	-11.9
COMMUNICATION CARRIER	B0217.	111	1	ON CREW CTR STA	1.6	1043.0	.0	-11.9
POCKET,SCISSORS (CDR)	B0218.	111	1	ON PGA CT CREW STA	.2	1043.0	.0	-11.9
POCKET,SCISSORS (LMP)	B0218.	111	1	ON PGA RH CREW STA	.2	1043.0	24.5	-11.9
POCKET,CHECKLIST (COR)	B0219.	111	1	ON PGA CT CREW STA	.2	1043.0	.0	-11.9
POCKET,CHECKLIST (LMP)	B0219.	111	1	ON PGA RH CREW STA	.2	1043.0	24.5	-11.9
POCKET,DATA(COR)	B0220.	111	1	ON PGA CT CREW STA	.2	1043.0	.0	-11.9
POCKET,DATA(LMP)	B0220.	111	1	ON CREW RH STA	.2	1043.0	24.5	-11.9
OXYGEN PURGE SYSTEM	B1012.	115	1	AREA A7	35.9	1011.0	22.0	8.0
BAG, HELMET STOWAGE	B1058.	115	1	IN CM PGA CONTAINER	1.4	1015.0	.0	-20.0
BAG, HELMET STOWAGE	B1058.	115	1	IN CM PGA CONTAINER	1.4	1015.0	.0	-20.0
LUNAR EXTRAVEHICULAR VISOR	B1014.	115	1	IN CM PGA CONTAINER	5.6	1015.0	.0	-20.0
LUNAR EXTRAVEHICULAR VISOR	B1014.	115	1	IN CM PGA CONTAINER	5.6	1015.0	.0	-20.0
GLOVES,EV-PAIR	B1015.	111	1	IN CM PGA CONTAINER	2.9	1015.0	.0	-20.0
GLOVES,EV-PAIR	B1015.	111	1	IN CM PGA CONTAINER	2.9	1015.0	.0	-20.0
KIT,EMU MAINTENANCE	B1016.	115	1	IN CM PGA CONTAINER	.5	1015.0	.0	-20.0
PURGE VALVE ASSY.	B1017.	115	1	AREA A7	.6	1011.0	22.0	8.0
TETHER, WAIST EVA	B1020.6	115	1	AREA A7	.6	1011.0	22.0	8.0
TETHER, WAIST EVA	B1020.7	115	1	AREA A7	.6	1011.0	22.0	8.0
GARMENT,LIQUID COOLING	B1030.	111	1	ON CREW RH STA	4.3	1043.0	24.5	-11.9
GARMENT,LIQUID COOLING	B1030.	111	1	ON CREW CTR STA	4.3	1043.0	.0	-11.9
DEVICE,IN-SUIT DRINKING	B1048.	111	1	ON CREW RH STA	.3	1043.0	24.5	-11.9
DEVICE,IN-SUIT DRINKING	B1048.	111	1	ON CREW CTR STA	.3	1043.0	.0	-11.9
ASSY,BIOINSTRUMENTATION	C0201.	111	1	ON CREW	1.1	1041.0	.0	-12.9
ASSY,BIOINSTRUMENTATION	C0201.	111	1	ON CREW	1.1	1041.0	.0	-12.9
DOSIMETER,PERSONAL	D0200.	117	1	ON CREW	.4	1046.0	.0	-23.4
DOSIMETER,PERSONAL	D0200.	117	1	ON CREW	.4	1046.0	.0	-23.4

3.1-94

SNA-8-D-027(III) REV 3

TABLE 3.1-9.2 (CONTINUED)

MISSION J-1 TRANSFERRED CREW AND EQUIPMENT STORAGE LIST								
ITEMS TRANSFERRED FROM ASC. STAGE INTO CM PRIOR TO ASC. STAGE JETTISON (16)								
APOLLO COORDINATES								
DESCRIPTION	STOW. ITEM	REF	NO.	STORAGE LOCATION	WEIGHT	X-C.G.	Y-C.G.	Z-C.G.
SAMPLES IN BAG 5	N/A	115	1	AREA B6	12.3	1031.0	13.0	39.0
BAG,SAMPLE RETURN	03060.	115	1	ON AREA A7	3.2	1019.0	22.0	8.0
SAMPLES IN 03060.	N/A	115	1	ON AREA A7	26.3	1019.0	22.0	8.0
SAMPLE COLLECTION BAG 4	G4056.	115	1	ON AREA A1	1.8	1017.0	-21.0	-22.0
BAG,SAMPLE CONTAINMENT	03078.	115	1	ON AREA A1	.5	1017.0	-21.0	-22.0
SAMPLES IN BAG 4	N/A	115	1	ON AREA A1	14.5	1017.0	-21.0	-22.0
BAG,SAMPLE COLLECTION	03078.	111	1	BETWEEN PGA AND A9	.5	1014.0	.0	8.0
SAMPLE COLLECTION BAG 3	G4048.	111	1	BETWEEN PGA AND A9	1.2	1014.0	.0	8.0
SAMPLES IN BAG 3	N/A	115	1	BETWEEN PGA AND A9	8.5	1014.0	.0	8.0
CORE TUBE+SAMPLES IN BAG 3	G4004.4	111	3	BETWEEN PGA AND A9	5.8	1014.0	.0	8.0
SAMPLE COLLECTION BAG 8	G4048.	111	1	AREA A9	1.2	1013.0	.0	16.0
SAMPLES IN BAG 8	N/A	115	1	AREA A9	9.8	1013.0	.0	16.0
BAG,SAMPLE CONTAINMENT	03078.	111	1	AREA A9	.5	1013.0	.0	16.0
CONTAINER,CORE TUBE	03074.	111	1	AREA A9	1.3	1013.0	.0	16.0
CORE TUBE+SAMPLE IN BAG 8	G4003.4	111	1	AREA A9	5.7	1013.0	.0	16.0
BAG,70MM MAGAZINE XFR	C6466.	111	1	AREA AR	.3	1011.0	21.0	-23.0
BAG,70MM MAGAZINE XFR	06466.	111	1	AREA R13	.3	1024.0	45.0	-26.0
BAG,ANCILLARY STOWAGE	T0100.	111	1	AREA AR	1.5	1011.0	21.0	-23.0
UTILITY STRAP	06315.	111	3	AREA R-5	.1	1059.0	44.0	15.0
INFLIGHT RETAINER STRAPS	00360.	111	4	AREA R-5	.1	1059.0	44.0	15.0
2 CREW+EQUIP,LH-CM					796.81	1033.86	8.88	-3.51

3.1-96

SNA-8-D-027(III) REV 3

Amendment 110
7/19/71

TABLE 3.1-9.2 (CONTINUED)

MISSION J-1 TRANSFERRED CREW AND EQUIPMENT STORAGE LIST								
ITEMS TRANSFERRED FROM CM INTO ASC, STAGE PRIOR TO ASC, STAGE JETTISON (17)								
APOLLO COORDINATES								
DESCRIPTION	STOW. ITEM	REF	NO.	STOWAGE LOCATION	WEIGHT	X-C.G.	Y-C.G.	Z-C.G.
CSM/LM UMBILICAL	TBD	222	1	UNDER RH COUCH	1.1	1018.0	24.5	-15.0
SUBSYSTEM, FECAL CONTAINMENT	B0113.	111	.1	ON CREW RH STA	.3	1043.0	24.5	-11.9
SUBSYSTEM, FECAL CONTAINMENT	B0113.	111	.1	ON CREW CTR STA	.3	1043.0	.0	-11.9
BAG, JETTISON STOWAGE	B0147.	111	1	AREA A2	.9	1011.0	-22.0	8.0
DEVICE, IN-SUIT DRINKING	B1048.	111	1	ON CREW RH STA	.3	1043.0	24.5	-11.9
DEVICE, IN-SUIT DRINKING	B1048.	111	1	ON CREW CTR STA	.3	1043.0	.0	-11.9
FOOD PACKAGE	C0111.	111	1	AREA A7	40.0	1011.0	22.0	8.0
FECAL COLLECTION ASSY	00311.	111	12	AREA A7	2.4	1011.0	22.0	8.0
CO2 ABSORBER USED	00327.	121	4	AREA B5	28.0	1031.0	-8.0	39.0
CO2 ABSORBER USED	00327.	121	4	AREA B6	28.0	1031.0	13.0	39.0
CO2 ABSORBER USED	00327.	121	4	AREA A9	28.0	1013.0	.0	16.0
SHIM, CO2 ABSORBER	00328.	161	4	AREA B5	.8	1031.0	-8.0	39.0
SHIM, CO2 ABSORBER	00328.	161	4	AREA B6	.8	1031.0	13.0	39.0
SHIMS, CO2 ABSORBER	00328.	161	4	AREA A9	.8	1013.0	.0	16.0
CONTAINER, B5	00342.	111	1	AREA B5	14.5	1031.0	-8.0	39.0
CONTAINER, B6	00343.	111	1	AREA B6	14.5	1031.0	13.0	39.0
DOCKING PROBE AND MECHANISM	00349.	222	1	IN CM TUNNEL	199.3	1110.3	.0	.0
BAG, FECAL COLLECTION ASSY.	0641A.	111	1	AREA A7	1.1	1011.0	22.0	8.0
EQUIP. XFR. CM-LM					361.40	1070.84	3.31	11.52

3.1-97

SMA-8-D-027(III) REV 3

U
 N
 I
 T
 E
 D
 S
 T
 A
 T
 E
 S
 A
 R
 M
 Y
 A
 I
 R
 F
 O
 R
 C
 E
 L
 E
 B
 R
 A
 T
 I
 O
 N
 S
 A
 N
 D
 S
 E
 R
 V
 I
 C
 E
 S

TABLE 3.1-9.2 (CONTINUED)

MISSION J-1 TRANSFERRED CREW AND EQUIPMENT STORAGE LIST								
ITEMS TRANSFERRED FROM CM INTO ASC. STAGE PRIOR TO ASC. STAGE JETTISON (18)								
						LM COORDINATES		
DESCRIPTION	STOW. ITEM	REF	NO.	STORAGE LOCATION	WEIGHT	X-C.G.	Y-C.G.	Z-C.G.
DOCKING STRUCTURE	TRD	111	1	ON CABIN FLOOR	111.7	218.5	-22.0	43.0
CSM/LM UMBILICAL	TRD	222	1	IN LM TUNNEL	1.1	300.0	.0	.0
SUBSYSTEM, FECAL CONTAINMENT	BC113.	111	.1	VOLUME CENTROID AS	.3	254.0	.0	.0
SUBSYSTEM, FECAL CONTAINMENT	RU113.	111	.1	VOLUME CENTROID AS	.3	254.0	.0	.0
BAG, JETTISON STOWAGE	RO147.	111	1	VOLUME CENTROID AS	.9	254.0	.0	.0
DEVICE, IN-SUIT DRINKING	RI048.	111	1	VOLUME CENTROID AS	.3	254.0	.0	.0
DEVICE, IN-SUIT DRINKING	BI048.	111	1	VOLUME CENTROID AS	.3	254.0	.0	.0
FOOD PACKAGE	CO111.	111	1	VOLUME CENTROID AS	40.0	254.0	.0	.0
FECAL COLLECTION ASSY	00311.	111	12	VOLUME CENTROID AS	2.4	254.0	.0	.0
CO2 ABSORBER USED	00327.	121	4	VOLUME CENTROID AS	28.0	254.0	.0	.0
CO2 ABSORBER USED	00327.	121	4	VOLUME CENTROID AS	28.0	254.0	.0	.0
CO2 ABSORBER USED	00327.	121	4	VOLUME CENTROID AS	28.0	254.0	.0	.0
SHIM, CO2 ABSORBER	00328.	161	4	VOLUME CENTROID AS	.8	254.0	.0	.0
SHIM, CO2 ABSORBER	00328.	161	4	VOLUME CENTROID AS	.8	254.0	.0	.0
SHIMS, CO2 ABSORBER	00328.	161	4	VOLUME CENTROID AS	.8	254.0	.0	.0
CONTAINER, B5	00342.	111	1	VOLUME CENTROID AS	14.5	254.0	.0	.0
CONTAINER, B6	00343.	111	1	VOLUME CENTROID AS	14.5	254.0	.0	.0
DOCKING PROBE	00349.	222	1	F8	87.6	221.0	18.0	51.0
BAG, FECAL COLLECTION ASSY.	06418.	111	1	VOLUME CENTROID AS	1.1	254.0	.0	.0
EQUIP. XFR. CM-LM					361.40	235.17	-2.44	25.65

3.1-98

SMA-8-D-027(III) REV 3

U
N
I
T
E
D
S
T
A
T
E
S
O
F
A
M
E
R
I
C
A

Amendment 110
7/19/71

TABLE 3.1-9.2 (CONTINUED)

MISSION J-1 TRANSFERRED CREW AND EQUIPMENT STORAGE LIST								
ITEMS REARRANGED IN ASC, STAGE PRIOR TO ASC, STAGE JETTISON (19)								
LM COORDINATES								
DESCRIPTION	STOW. ITEM	REF	NO.	STORAGE LOCATION	HEIGHT	X-C.G.	Y-C.G.	Z-C.G.
DOCKING DROGUE	F1900.	112	1	IN LM TUNNEL	21.4	300.0	.0	.0
LM EQUIP. RELOC. 3					21.40	300.00	.00	.00

3.1-99

SNA-8-D-027(III) REV 3

TABLE 3.1-9.2 (CONTINUED)

MISSION J-1 TRANSFERRED CREW AND EQUIPMENT STORAGE LIST								
ITEMS REARRANGED IN CH POST A/S JETTISON (21)								
						APOLLO COORDINATES		
DESCRIPTION	STOW. ITEM	REF	NO.	STORAGE LOCATION	WEIGHT	X-C.G.	Y-C.G.	Z-C.G.
BAG, DECONTAMINATION, 1 SA	06427.	111	1	TOP OF AREA A-2	5.0	1016.0	-22.0	0.0
BAG, MOTION SICKNESS	A020A.	111	1	ON CREW	.1	1043.0	.0	-21.0
BAG, MOTION SICKNESS	AG20B.	111	1	ON CREW	.1	1043.0	.0	-21.0
BAG, MOTION SICKNESS	AG20B.	111	1	ON CREW	.1	1043.0	.0	-21.0
JACKET ASSY, ICG	B0112.1	111	1	AREA U2	1.8	1033.0	-23.0	-50.0
JACKET ASSY, ICG	R0112.1	111	1	AREA U2	1.8	1033.0	-23.0	-50.0
JACKET ASSY, ICG	R0112.1	111	1	AREA U2	1.8	1033.0	-23.0	-50.0
TROUSER ASSY, ICG	R0112.2	111	1	AREA U2	1.8	1033.0	-23.0	-50.0
TROUSER ASSY, ICG	R0112.2	111	1	AREA U2	1.8	1033.0	-23.0	-50.0
TROUSER ASSY, ICG	R0112.2	111	1	AREA U2	1.8	1033.0	-23.0	-50.0
BOOT, RIGHT, ICG	R0112.3	111	1	AREA U2	.4	1033.0	-23.0	-50.0
BOOT, RIGHT, ICG	R0112.3	111	1	AREA U2	.4	1033.0	-23.0	-50.0
BOOT, RIGHT, ICG	R0112.3	111	1	AREA U2	.4	1033.0	-23.0	-50.0
BOOT, LEFT, ICG	B0112.4	111	1	AREA U2	.4	1033.0	-23.0	-50.0
BOOT, LEFT, ICG	R0112.4	111	1	AREA U2	.4	1033.0	-23.0	-50.0
BOOT, LEFT, ICG	R0112.4	111	1	AREA U2	.4	1033.0	-23.0	-50.0
SUBSYSTEM, FECAL CONTAINMENT	B0113.	111	1	ON CREW LH STA	.3	1043.0	-24.5	-11.9
HARNESS, CWG ELECTRICAL (CMP)	R0135.	111	1	IN ADAPTER BAG (AB)	.4	1011.0	21.0	-23.0
HARNESS, CWG ELECTRICAL (CDR)	B0135.	111	1	IN ADAPTER BAG (AB)	.4	1011.0	21.0	-23.0
HARNESS, CWG ELECTRICAL (LMP)	R0135.	111	1	IN ADAPTER BAG (AB)	.4	1011.0	21.0	-23.0
UCTA	R0205.	111	1	ON CREW	.5	1043.0	.0	-5.9
UCTA	R0205.	111	1	ON CREW	.5	1043.0	.0	-5.9
UCTA	R0223.	111	1	ON CREW	.5	1043.0	.0	-5.9
ITLSA - EV	R0211.	111		ON CREW RH STA	46.9	1043.0	24.5	-11.9
ITLSA - EV	R0211.	111		ON CREW CTR STA	46.9	1043.0	.0	-11.9
ITLSA - EV	R0212.	111		ON CREW LH STA	41.8	1043.0	-24.5	-11.9
GLOVES, IV PAIR	R0213.	111	1	ON CREW LH STA	2.0	1043.0	-24.5	-11.9
GLOVES, IV PAIR	B0213.	111	1	ON CREW RH STA	2.0	1043.0	24.5	-11.9
GLOVES, IV PAIR	R0213.	111	1	ON CREW CTR STA	2.0	1043.0	.0	-11.9
HELMET ASSY, PRESSURE	R0214.	111	1	ON CREW LH STA	2.6	1043.0	-24.5	-11.9
HELMET ASSY, PRESSURE	R0214.	111	1	ON CREW RH STA	2.6	1043.0	24.5	-11.9
HELMET ASSY, PRESSURE	R0214.	111	1	ON CREW CTR STA	2.6	1043.0	.0	-11.9

3.1-101

SNA-8-D-027(III) REV 3

TABLE 3.1-9.2 (CONTINUED)

MISSION J-1 TRANSFERRED CREW AND EQUIPMENT STORAGE LIST									
ITEMS REARRANGED IN CM POST A/S JETTISON (21)									
							APOLLO COORDINATES		
DESCRIPTION	STOW. ITEM	REF	NO.	STORAGE LOCATION	HEIGHT	X-C.G.	Y-C.G.	Z-C.G.	
COMMUNICATION CARRIER	R0217.	111	1	ON CREW LH STA	1.6	1043.0	-24.5	-11.9	
COMMUNICATION CARRIER	R0217.	111	1	ON CREW RH STA	1.6	1043.0	24.5	-11.9	
COMMUNICATION CARRIER	R0217.	111	1	ON CREW CTR STA	1.6	1043.0	.0	-11.9	
POCKET, SCISSORS (CMP)	R0218.	111	1	ON PGA LH CREW STA	.2	1043.0	-24.5	-11.9	
POCKET, SCISSORS (CDR)	R0218.	111	1	ON PGA CT CREW STA	.2	1043.0	.0	-11.9	
POCKET, SCISSORS (LMP)	R0218.	111	1	ON PGA RH CREW STA	.2	1043.0	24.5	-11.9	
POCKET, CHECKLIST (CDR)	R0219.	111	1	ON PGA CT CREW STA	.2	1043.0	.0	-11.9	
POCKET, CHECKLIST (LMP)	R0219.	111	1	ON PGA RH CREW STA	.2	1043.0	24.5	-11.9	
POCKET, DATA (CDR)	R0220.	111	1	ON PGA CT CREW STA	.2	1043.0	.0	-11.9	
POCKET, DATA (LMP)	R0220.	111	1	ON PGA RH CREW STA	.2	1043.0	24.5	-11.9	
POCKET, CHECKLIST (CMP)	R0221.	111	1	ON PGA LH CREW STA	.2	1043.0	-24.5	-11.9	
POCKET, DATA (CMP)	R0222.	111	1	ON PGA LH CREW STA	.2	1043.0	-24.5	-11.9	
GARMENT, LIQUID COOLING	R1030.	111	1	ON CREW RH STA	4.3	1043.0	24.5	-11.9	
GARMENT, LIQUID COOLING	R1030.	111	1	ON CREW CTR STA	4.3	1043.0	.0	-11.9	
HEADSET, LIGHTWEIGHT	E0111.	111	1	AREA A8	.4	1011.0	21.0	-23.0	
HEADSET, LIGHTWEIGHT	E0112.	111	1	AREA A8	.4	1011.0	21.0	-23.0	
HEADSET, LIGHTWEIGHT	E0113.	111	1	AREA A8	.4	1011.0	21.0	-23.0	
EARTUBE, UNIVERSAL (CMP)	E0114.	111	1	AREA U2	NEGL	1033.0	-23.0	-50.0	
EARTUBE, UNIVERSAL (CDR)	E0115.	111	1	AREA U2	NEGL	1033.0	-23.0	-50.0	
EARTUBE, UNIVERSAL (LMP)	E0116.	111	1	AREA U2	NEGL	1033.0	-23.0	-50.0	
DECON. BAG, L.S. HASSELBLAD MAG.	06330.	111	1	TOP OF AREA A-2	.7	1016.0	-22.0	8.0	
CARRIER ASSY, CONT. A9	06403.	111	1	AREA A9	2.5	1013.0	.0	16.0	
TETHER, IV CREWMAN	06429.	111	1	AREA A2	.5	1011.0	-22.0	8.0	
BAG, DECONTAMINATION 16MM MAG.	06433.	111	1	AREA A2	.3	1011.0	-22.0	8.0	
BAG, DECONTAMINATION 70MM MAG.	06435.	111	1	AREA A2	.3	1011.0	-22.0	8.0	
DECON BAG, PENETROMETER	06461.	111	1	TOP OF AREA A-2	.8	1016.0	-22.0	8.0	
DECONTAMINATION BAG, L.S. SAMPLE		111	1	TOP OF AREA A-2	.9	1016.0	-22.0	8.0	
BAG, DECONTAMINATION, SRC NO.1	06331.	111	1	TOP OF AREA A-2	.9	1016.0	-22.0	8.0	
DECONTAMINATION BAG, SRC NO.2	06331.	111	1	TOP OF AREA A-2	.9	1016.0	-22.0	8.0	
BAG, DECON. LUNAR SAMPLE	06426.	111	1	TOP OF AREA A-2	5.0	1016.0	-22.0	8.0	
DECONTAMINATION BAG	TBD	115	1	TOP OF AREA A-2	.9	1016.0	-22.0	8.0	
BAG, DECON, LUNAR SURFACE	TBD	111	1	AREA A2	.9	1011.0	-22.0	8.0	

3.1-102

SNA-8-D-027(III) REV 3

U
N
I
F
E
R
E
N
C
E
S
A
R
E
L
I
S
T
E
D
H
E
R
E

TABLE 3.1-9.2 (CONTINUED)

Amendment 110
7/19/71

MISSION J-1 TRANSFERRED CREW AND EQUIPMENT STORAGE LIST								
ITEMS REARRANGED IN CM POST A/S JETTISON (21)								
APOLLO COORDINATES								
DESCRIPTION	STOW. ITEM	REF	NO.	STORAGE LOCATION	WEIGHT	X-C.G.	Y-C.G.	Z-C.G.
BAG, DECON, 16MM MAGAZINE	06467.	111	1	TOP OF AREA A-2	.1	1016.0	-22.0	8.0
BAG, DECON, 70MM MAGAZINE	06468.	111	1	TOP OF AREA A-2	.3	1016.0	-22.0	8.0
BAG, DECON, 70MM MAGAZINE	06469.	111	1	TOP OF AREA A-2	.3	1016.0	-22.0	8.0
BAG, DECONTAMINATION	06426.	111	1	TOP OF AREA A-2	5.0	1016.0	-22.0	8.0
BAG, DECON LUNAR ROCK	06470.	111	1	TOP OF AREA A-2	5.0	1016.0	-22.0	8.0
PLATE, REINFORCEMENT	06471.	111	1	TOP OF AREA A-2	1.5	1016.0	-22.0	8.0
CM EQUIP. RELOC.3					213.60	1037.98	-3.11	-11.34

3.1-103

SNA-8-D-027(111) REV 3

TABLE 3.1-9.2 (CONTINUED)

MISSION J-1 TRANSFERRED CREW AND EQUIPMENT STORAGE LIST								
ITEMS REARRANGED IN CM POST A/S JETTISON (22)								
APOLLO COORDINATES								
DESCRIPTION	STOW. ITEM	REF	NO.	STORAGE LOCATION	WEIGHT	X-C.G.	Y-C.G.	Z-C.G.
BAG, DECONTAMINATION, ISA	06427.	111	1	ON AREA A2	5.0	1019.0	-22.0	8.0
BAG, MOTION SICKNESS	A020A.	111	1	ON PGA (PGA CONT)	.1	1011.0	.0	-14.0
BAG, MOTION SICKNESS	A020B.	111	1	ON PGA (PGA CONT)	.1	1011.0	.0	-14.0
BAG, MOTION SICKNESS	A020C.	111	1	ON PGA (PGA CONT)	.1	1011.0	.0	-14.0
JACKET ASSY, ICG	B0112.1	111	1	ON CREW RH STA	1.8	1043.0	24.5	-11.9
JACKET ASSY, ICG	R0112.1	111	1	ON CREW CTR STA	1.8	1043.0	.0	-11.9
JACKET ASSY, ICG	B0112.1	111	1	ON CREW LH STA	1.8	1043.0	-24.5	-11.9
TROUSER ASSY, ICG	B0112.2	111	1	ON CREW RH STA	1.8	1043.0	24.5	-11.9
TROUSER ASSY, ICG	R0112.2	111	1	ON CREW CTR STA	1.8	1043.0	.0	-11.9
TROUSER ASSY, ICG	R0112.2	111	1	ON CREW LH STA	1.8	1043.0	-24.5	-11.9
BOOT, RIGHT, ICG	R0112.3	111	1	ON CREW RH STA	.4	1043.0	24.5	-11.9
BOOT, RIGHT, ICG	R0112.3	111	1	ON CREW CTR STA	.4	1043.0	.0	-11.9
BOOT, RIGHT, ICG	R0112.3	111	1	ON CREW LH STA	.4	1043.0	-24.5	-11.9
BOOT, LEFT, ICG	R0112.4	111	1	ON CREW RH STA	.4	1043.0	24.5	-11.9
BOOT, LEFT, ICG	B0112.4	111	1	ON CREW CTR STA	.4	1043.0	.0	-11.9
BOOT, LEFT, ICG	R0112.4	111	1	ON CREW LH STA	.4	1043.0	-24.5	-11.9
SUBSYSTEM, FECAL CONTAINMENT	B0113.	111	1	AREA A2	.3	1011.0	-22.0	8.0
HARNESS, CWG ELECTRICAL (CMP)	R0135.	111	1	ON CREW LH STA	.4	1043.0	-24.5	-11.9
HARNESS, CWG ELECTRICAL (COR)	B0135.	111	1	ON CREW CTR STA	.4	1043.0	.0	-11.9
HARNESS, CWG ELECTRICAL (LMP)	R0135.	111	1	ON CREW RH STA	.4	1043.0	24.5	-11.9
UCTA	R0205.	111	1	IN CM PGA CONTAINER	.5	1015.0	.0	-20.0
UCTA	B0205.	111	1	IN CM PGA CONTAINER	.5	1015.0	.0	-20.0
UCTA	R0223.	111	1	IN CM PGA CONTAINER	.5	1015.0	.0	-20.0
ITLSA - EV	R0211.	111		ITLSA IN PGA CONT.	46.9	1011.0	.0	-20.0
ITLSA - EV	R0211.	111		ITLSA IN PGA CONT.	46.9	1011.0	.0	-20.0
ITLSA - EV	R0212.	111		SLEEP RESTRAINT - RT	41.8	1018.0	23.0	-50.0
GLOVES, IV PAIR	R0213.	111	1	HELMET STOW BAG (L3)	2.0	1048.0	-47.0	12.0
GLOVES, IV PAIR	R0213.	111	1	HELMET STOW BAG (R1)	2.0	1050.0	-27.0	39.0
GLOVES, IV PAIR	R0213.	111	1	AFT UER (RIGHT)	2.0	1018.0	23.0	-51.0
HELMET ASSY, PRESSURE	R0214.	111	1	AFT UER (RIGHT)	2.6	1018.0	23.0	-51.0
HELMET ASSY, PRESSURE	R0214.	111	1	HELMET STOW BAG (R1)	2.6	1050.0	-27.0	39.0
HELMET ASSY, PRESSURE	R0214.	111	1	HELMET STOW BAG (L3)	2.6	1048.0	-47.0	12.0

3.1-104

SNA-8-D-027(III) REV 3

TABLE 3.1-9.2 (CONTINUED)

MISSION J-1 TRANSFERRED CREW AND EQUIPMENT STOWAGE LIST								
ITEMS REARRANGED IN CM POST A/S JETTISON (22)								
APOLLO COORDINATES								
DESCRIPTION	STOW. ITEM	REF	NO.	STOWAGE LOCATION	WEIGHT	X-C.G.	Y-C.G.	Z-C.G.
COMMUNICATION CARRIER	R0217.	111	1	GNIC PANEL	1.6	1050.0	.0	22.0
COMMUNICATION CARRIER	R0217.	111	1	GNIC PANEL	1.6	1050.0	.0	22.0
COMMUNICATION CARRIER	R0217.	111	1	GNIC PANEL	1.6	1050.0	.0	22.0
POCKET, SCISSORS (CMP)	R0218.	111	1	ON ICG LH STA	.2	1043.0	-24.5	-11.9
POCKET, SCISSORS (CDR)	R0218.	111	1	ON ICG CTR STA	.2	1043.0	.0	-11.9
POCKET, SCISSORS (LMP)	R0218.	111	1	ON ICG RH STA	.2	1043.0	24.5	-11.9
POCKET, CHECKLIST (CDR)	R0219.	111	1	ON ICG CTR STA	.2	1043.0	.0	-11.9
POCKET, CHECKLIST (LMP)	R0219.	111	1	ON ICG RH STA	.2	1043.0	24.5	-11.9
POCKET, DATA (CDR)	R0220.	111	1	ON ICG CTR STA	.2	1043.0	.0	-11.9
POCKET, DATA (LMP)	R0220.	111	1	ON ICG RH STA	.2	1043.0	24.5	-11.9
POCKET, CHECKLIST (CMP)	R0221.	111	1	ON ICG LH STA	.2	1043.0	-24.5	-11.9
POCKET, DATA (CMP)	R0222.	111	1	ON ICG LH STA	.2	1043.0	-24.5	-11.9
GARMENT, LIQUID COOLING	R1030.	111	1	AREA U1	4.3	1033.0	23.0	-50.0
GARMENT, LIQUID COOLING	R1030.	111	1	AREA U1	4.3	1033.0	23.0	-50.0
HEADSET, LIGHTWEIGHT	E0111.	111	1	ON CREW RH STA	.4	1043.0	24.5	-11.9
HEADSET, LIGHTWEIGHT	E0112.	111	1	ON CREW CTR STA	.4	1043.0	.0	-11.9
HEADSET, LIGHTWEIGHT	E0113.	111	1	ON CREW LH STA	.4	1043.0	-24.5	-11.9
EARTUBE, UNIVERSAL (CMP)	E0114.	111	1	ON CREW LH STA	NEGL	1043.0	-24.5	-11.9
EARTUBE, UNIVERSAL (CDR)	E0115.	111	1	ON CREW CTR STA	NEGL	1043.0	.0	-11.9
EARTUBE, UNIVERSAL (LMP)	E0116.	111	1	ON CREW RH STA	NEGL	1043.0	24.5	-11.9
DECON. BAG, L.S. MASSFLBLAO MAG.	06330.	111	1	AREA R13	.2	1024.0	45.0	-26.0
CARRIER ASSY, CONT. A9	06403.	111	1	AREA A9	2.5	1013.0	.0	16.0
TETHER, IV CREWMAN	06429.	111	1	AREA A7	.5	1011.0	22.0	8.0
BAG, DECONTAMINATION 16MM MAG.	06433.	111	1	AREA R13	.3	1024.0	45.0	-26.0
BAG, DECONTAMINATION 70MM MAG.	06435.	111	1	AREA R13	.3	1024.0	45.0	-26.0
DECON BAG, PENETROMETER	06461.	111	1	AREA A7	.8	1011.0	22.0	8.0
DECONTAMINATION BAG, L.S. SAMPLE		111	1	ON AREA A1	.9	1017.0	-21.0	-22.0
BAG, DECONTAMINATION, SRC NO. 1	06331.	111	1	AREA B5	.9	1031.0	-8.0	39.0
DECONTAMINATION BAG, SRC NO. 2	06331.	111	1	AREA B6	.9	1031.0	13.0	39.0
BAG, DECON. LUNAR SAMPLE	06426.	111	1	ON AREA A7	5.0	1019.0	22.0	8.0
DECONTAMINATION BAG	TBD	115	1	ON AREA A1	.9	1017.0	-21.0	-22.0
BAG, DECON, LUNAR SURFACE	TBD	111	1	BETWEEN PGA AND A9	.9	1014.0	.0	8.0

3.1-105

SNA-8-D-027(III) REV 3

TABLE 3.1-9.2 (CONTINUED)

Amendment 110
7/19/71

MISSION J-1 TRANSFERRED CREW AND EQUIPMENT STORAGE LIST								
ITEMS REARRANGED IN CM POST A/S JETTISON (22)								
DESCRIPTION	STOW. ITEM	REF	NO.	STOWAGE LOCATION	WEIGHT	APOLLO COORDINATES		
						X-C.G.	Y-C.G.	Z-C.G.
BAG, DECON, 16MM MAGAZINE	06467.	111	1	AREA R13	.1	1024.0	45.0	-26.0
BAG, DECON, 70MM MAGAZINE	06468.	111	1	AREA R13	.3	1024.0	45.0	-26.0
BAG, DECON, 70MM MAGAZINE	06469.	111	1	AREA AB	.3	1011.0	21.0	-23.0
BAG, DECONTAMINATION	06426.	111	1	ON AREA A1	5.0	1017.0	-21.0	-22.0
BAG, DECON LUNAR ROCK	06470.	111	1	BETWEEN PGA AND A9	5.0	1014.0	.0	8.0
PLATE, REINFORCEMENT	06471.	111	1	BETWEEN PGA AND A9	1.5	1014.0	.0	8.0
CM EQUIP. RELOC. 3					213.60	1019.49	4.07	-20.87

3.1-106

SMA-8-D-027(111) REV 3

TABLE 3.1-9.2 (CONTINUED)

MISSION J-1 TRANSFERRED CREW AND EQUIPMENT STORAGE LIST								
ITEMS REARRANGED IN CM PRIOR TO PRE CSM AT EVA (23)								
APOLLO COORDINATES								
DESCRIPTION	STOW. ITEM	REF	NO.	STOWAGE LOCATION	WEIGHT	X-C.G.	Y-C.G.	Z-C.G.
BAG, MOTION SICKNESS	A0208.	111	1	ON PGA (PGA CONT)	.1	1011.0	.0	-14.0
BAG, MOTION SICKNESS	A0208.	111	1	ON PGA (PGA CONT)	.1	1011.0	.0	-14.0
BAG, MOTION SICKNESS	A0208.	111	1	ON PGA (PGA CONT)	.1	1011.0	.0	-14.0
JACKET ASSY, ICG	R0112.1	111	1	ON CREW RH STA	1.8	1043.0	24.5	-11.9
JACKET ASSY, ICG	R0112.1	111	1	ON CREW CTR STA	1.8	1043.0	.0	-11.9
JACKET ASSY, ICG	R0112.1	111	1	ON CREW LH STA	1.8	1043.0	-24.5	-11.9
TROUSER ASSY, ICG	R0112.2	111	1	ON CREW RH STA	1.8	1043.0	24.5	-11.9
TROUSER ASSY, ICG	R0112.2	111	1	ON CREW CTR STA	1.8	1043.0	.0	-11.9
TROUSER ASSY, ICG	R0112.2	111	1	ON CREW LH STA	1.8	1043.0	-24.5	-11.9
BOOT, RIGHT, ICG	R0112.3	111	1	ON CREW RH STA	.4	1043.0	24.5	-11.9
BOOT, RIGHT, ICG	R0112.3	111	1	ON CREW CTR STA	.4	1043.0	.0	-11.9
BOOT, RIGHT, ICG	R0112.3	111	1	ON CREW LH STA	.4	1043.0	-24.5	-11.9
BOOT, LEFT, ICG	R0112.4	111	1	ON CREW RH STA	.4	1043.0	24.5	-11.9
BOOT, LEFT, ICG	R0112.4	111	1	ON CREW CTR STA	.4	1043.0	.0	-11.9
BOOT, LEFT, ICG	R0112.4	111	1	ON CREW LH STA	.4	1043.0	-24.5	-11.9
SUBSYSTEM, FECAL CONTAINMENT	B0113.	111	1	AREA A2	.3	1011.0	-22.0	8.0
UCTA	R0205.	111	1	IN CM PGA CONTAINER	.5	1015.0	.0	-20.0
UCTA	R0205.	111	1	IN CM PGA CONTAINER	.5	1015.0	.0	-20.0
UCTA	R0223.	111	1	IN CM PGA CONTAINER	.5	1015.0	.0	-20.0
ITLSA - EV	R0211.	111		ITLSA IN PGA CONT.	46.9	1011.0	.0	-20.0
ITLSA - EV	R0211.	111		ITLSA IN PGA CONT.	46.9	1011.0	.0	-20.0
ITLSA - EV	R0212.	111		SLEEP RESTRAINT - RT	41.8	1018.0	23.0	-50.0
GLOVES, IV PAIR	R0213.	111	1	HELMET STOW. BAG (L3)	2.0	1048.0	-47.0	12.0
GLOVES, IV PAIR	R0213.	111	1	HELMET STOW. BAG (B1)	2.0	1050.0	-27.0	39.0
GLOVES, IV PAIR	R0213.	111	1	AFT UEB (RIGHT)	2.0	1018.0	23.0	-51.0
HELMET ASSY, PRESSURE	R0214.	111	1	AFT UEB (RIGHT)	2.6	1018.0	23.0	-51.0
HELMET ASSY, PRESSURE	R0214.	111	1	HELMET STOW. BAG (B1)	2.6	1050.0	-27.0	39.0
HELMET ASSY, PRESSURE	R0214.	111	1	HELMET STOW. BAG (L3)	2.6	1048.0	-47.0	12.0
COMMUNICATION CARRIER	R0217.	111	1	GNIC PANEL	1.6	1050.0	.0	22.0
COMMUNICATION CARRIER	R0217.	111	1	GNIC PANEL	1.6	1050.0	.0	22.0
COMMUNICATION CARRIER	R0217.	111	1	GNIC PANEL	1.6	1050.0	.0	22.0
POCKET, SCISSORS (CMP)	R0218.	111	1	ON ICG LH STA	.2	1043.0	-24.5	-11.9

3.1-107

SNA-8-D-027(III) REV 3

TABLE 3.1-9.2 (CONTINUED)

MISSION J-1 TRANSFERRED CREW AND EQUIPMENT STORAGE LIST							APOLLO COORDINATES		
ITEMS REARRANGED IN CM PRIOR TO PRE CSM AT EVA (23)							X-C.G.	Y-C.G.	Z-C.G.
DESCRIPTION	STOW. ITEM	REF	NO.	STOWAGE LOCATION	WEIGHT				
POCKET, SCISSORS (CDR)	B021A.	111	1	ON ICG CTR STA	.2	1043.0	.0	-11.9	
POCKET, SCISSORS (LMP)	B021A.	111	1	ON ICG RH STA	.2	1043.0	24.5	-11.9	
POCKET, CHECKLIST (CDR)	R0219.	111	1	ON ICG CTR STA	.2	1043.0	.0	-11.9	
POCKET, CHECKLIST (LMP)	R0219.	111	1	ON ICG RH STA	.2	1043.0	24.5	-11.9	
POCKET, DATA (CDR)	B0220.	111	1	ON ICG CTR STA	.2	1043.0	.0	-11.9	
POCKET, DATA (LMP)	R0220.	111	1	ON ICG RH STA	.2	1043.0	24.5	-11.9	
POCKET, CHECKLIST (CMP)	R0221.	111	1	ON ICG LH STA	.2	1043.0	-24.5	-11.9	
POCKET, DATA (CMP)	R0222.	111	1	ON ICG LH STA	.2	1043.0	-24.5	-11.9	
HEADSET, LIGHTWEIGHT	E0111.	111	1	ON CREW RH STA	.4	1043.0	24.5	-11.9	
HEADSET, LIGHTWEIGHT	F0112.	111	1	ON CREW CTR STA	.4	1043.0	.0	-11.9	
HEADSET, LIGHTWEIGHT	E0113.	111	1	ON CREW LH STA	.4	1043.0	-24.5	-11.9	
EARTUBE, UNIVERSAL (CMP)	EC114.	111	1	ON CREW LH STA	NEGL	1043.0	-24.5	-11.9	
EARTUBE, UNIVERSAL (CDR)	F0115.	111	1	ON CREW CTR STA	NEGL	1043.0	.0	-11.9	
EARTUBE, UNIVERSAL (LMP)	F0116.	111	1	ON CREW RH STA	NEGL	1043.0	24.5	-11.9	
CM EQUIP. RELOC. 4					172.50	1019.04	4.17	-23.68	

3.1-108

SNA-8-D-027(III) REV 3

TABLE 3.1-9.2 (CONTINUED)

MISSION J-1 TRANSFERRED CREW AND EQUIPMENT STORAGE LIST								
ITEMS REARRANGED IN CM PRIOR TO PRE CSM AT EVA (24)								
						APOLLO COORDINATES		
DESCRIPTION	STOW. ITEM	REF	NO.	STOWAGE LOCATION	WEIGHT	X-C.G.	Y-C.G.	Z-C.G.
BAG, MOTION SICKNESS	A020R.	111	1	ON CREW	.1	1043.0	.0	-21.0
BAG, MOTION SICKNESS	A020R.	111	1	ON CREW	.1	1043.0	.0	-21.0
BAG, MOTION SICKNESS	A020R.	111	1	ON CREW	.1	1043.0	.0	-21.0
JACKET ASSY, ICG	B0112.1	111	1	AREA U2	1.8	1033.0	-23.0	-50.0
JACKET ASSY, ICG	R0112.1	111	1	AREA U2	1.8	1033.0	-23.0	-50.0
JACKET ASSY, ICG	R0112.1	111	1	AREA U2	1.8	1033.0	-23.0	-50.0
TROUSER ASSY, ICG	R0112.2	111	1	AREA U2	1.8	1033.0	-23.0	-50.0
TROUSER ASSY, ICG	R0112.2	111	1	AREA U2	1.8	1033.0	-23.0	-50.0
TROUSER ASSY, ICG	R0112.2	111	1	AREA U2	1.8	1033.0	-23.0	-50.0
BOOT, RIGHT, ICG	R0112.3	111	1	AREA U2	.4	1033.0	-23.0	-50.0
BOOT, RIGHT, ICG	R0112.3	111	1	AREA U2	.4	1033.0	-23.0	-50.0
BOOT, RIGHT, ICG	R0112.3	111	1	AREA U2	.4	1033.0	-23.0	-50.0
BOOT, LEFT, ICG	R0112.4	111	1	AREA U2	.4	1033.0	-23.0	-50.0
BOOT, LEFT, ICG	R0112.4	111	1	AREA U2	.4	1033.0	-23.0	-50.0
BOOT, LEFT, ICG	R0112.4	111	1	AREA U2	.4	1033.0	-23.0	-50.0
SUBSYSTEM, FECAL CONTAINMENT	R0113.	111	1	ON CREW LH STA	.3	1043.0	-24.5	-11.9
UCTA	R0205.	111	1	ON CREW	.5	1043.0	.0	-5.9
UCTA	R0205.	111	1	ON CREW	.5	1043.0	.0	-5.9
UCTA	R0223.	111	1	ON CREW	.5	1043.0	.0	-5.9
ITLSA - EV	R0211.	111		ON CREW RH STA	46.9	1043.0	24.5	-11.9
ITLSA - EV	R0211.	111		ON CREW CTR STA	46.9	1043.0	.0	-11.9
ITLSA - EV	R0212.	111		ON CREW LH STA	41.8	1043.0	-24.5	-11.9
GLOVES, IV PAIR	R0213.	111	1	ON CREW LH STA	2.0	1043.0	-24.5	-11.9
GLOVES, IV PAIR	R0213.	111	1	ON CREW RH STA	2.0	1043.0	24.5	-11.9
GLOVES, IV PAIR	R0213.	111	1	ON CREW CTR STA	2.0	1043.0	.0	-11.9
HELMET ASSY, PRESSURE	R0214.	111	1	ON CREW LH STA	2.6	1043.0	-24.5	-11.9
HELMET ASSY, PRESSURE	R0214.	111	1	ON CREW RH STA	2.6	1043.0	24.5	-11.9
HELMET ASSY, PRESSURE	R0214.	111	1	ON CREW CTR STA	2.6	1043.0	.0	-11.9
COMMUNICATION CARRIER	R0217.	111	1	ON CREW LH STA	1.6	1043.0	-24.5	-11.9
COMMUNICATION CARRIER	R0217.	111	1	ON CREW RH STA	1.6	1043.0	24.5	-11.9
COMMUNICATION CARRIER	R0217.	111	1	ON CREW CTR STA	1.6	1043.0	.0	-11.9
POCKET, SCISSORS (CMP)	R021R.	111	1	ON PGA LH CREW STA	.2	1043.0	-24.5	-11.9

3.1-109

SNA-8-D-027(III) REV 3

U
N
I
T
E
D
S
T
A
T
E
S
O
F
A
M
E
R
I
C
A

TABLE 3.1-9.2 (CONTINUED)

MISSION J-1 TRANSFERRED CREW AND EQUIPMENT STORAGE LIST								
ITEMS REARRANGED IN CM PRIOR TO PRE CSM AT EVA (24)								
APOLLO COORDINATES								
DESCRIPTION	STOW. ITEM	REF	NO.	STORAGE LOCATION	WEIGHT	X-C.G.	Y-C.G.	Z-C.G.
POCKET,SCISSORS (CDR)	R021R.	111	1	ON PGA CT CREW STA	.2	1043.0	.0	-11.9
POCKET,SCISSORS (LMP)	R021P.	111	1	ON PGA RH CREW STA	.2	1043.0	24.5	-11.9
POCKET,CHECKLIST (CDR)	R0219.	111	1	ON PGA CT CREW STA	.2	1043.0	.0	-11.9
POCKET,CHECKLIST (LMP)	R0219.	111	1	ON PGA RH CREW STA	.2	1043.0	24.5	-11.9
POCKET,DATA(CDR)	R0220.	111	1	ON PGA CT CREW STA	.2	1043.0	.0	-11.9
POCKET,DATA(LMP)	R0220.	111	1	ON PGA RH CREW STA	.2	1043.0	24.5	-11.9
POCKET,CHECKLIST (CMP)	R0221.	111	1	ON PGA LH CREW STA	.2	1043.0	-24.5	-11.9
POCKET,DATA(CMP)	R0222.	111	1	ON PGA LH CREW STA	.2	1043.0	-24.5	-11.9
HEADSET,LIGHTWEIGHT	E0111.	111	1	AREA A8	.4	1011.0	21.0	-23.0
HEADSET,LIGHTWEIGHT	E0112.	111	1	AREA A8	.4	1011.0	21.0	-23.0
HEADSET,LIGHTWEIGHT	E0113.	111	1	AREA A8	.4	1011.0	21.0	-23.0
EARTUBE,UNIVERSAL (CMP)	F0114.	111	1	AREA U2	NEGL	1033.0	-23.0	-50.0
EARTUBE,UNIVERSAL (CDR)	E0115.	111	1	AREA U2	NEGL	1033.0	-23.0	-50.0
EARTUBE,UNIVERSAL (LMP)	E0116.	111	1	AREA U2	NEGL	1033.0	-23.0	-50.0
CM EQUIP.RELOC.4					172.50	1042.01	-0.93	-14.86

3.1-110

SNA-8-D-027(III) REV 3

P
H
H
H
H
H
H
L
L
L
H
H
H
H
H
H
H
H
L
L
L
L

Amendment 110
7/19/71

TABLE 3.1-9.2 (CONTINUED)

MISSION J-1 TRANSFERRED CREW AND EQUIPMENT STORAGE LIST								
ITEMS TRANSFERRED FROM SM TO CM DURING SIM EVA (25)								
DESCRIPTION	STOW. ITEM	REF	NO.	STOWAGE LOCATION	WEIGHT	APOLLO COORDINATES		
						X-C.G.	Y-C.G.	Z-C.G.
MAGAZINE, 24 IN. PAN. CAMERA	PD40P.	111	1	IN SIM RAY (3IN)	72.0	945.5	34.5	-52.5
MAGAZINE, 3 IN. MAP. CAMERA	PD40I.	111	1	IN SIM RAY (24 IN)	22.3	886.0	53.0	-56.0
EQUIP. XFR. SM-CM					94.30	931.43	38.87	-53.33

3.1-111

SMA-8-D-027(111) REV 3

TABLE 3.1-9.2 (CONTINUED)

Amendment 110
7/19/71

MISSION J-1 TRANSFERRED CREW AND EQUIPMENT STORAGE LIST								
ITEMS TRANSFERRED FROM SM TO CM DURING SIM EVA (26)								
						APOLLO COORDINATES		
DESCRIPTION	STOW. ITEM	REF	NO.	STOWAGE LOCATION	WEIGHT	X-C.G.	Y-C.G.	Z-C.G.
MAGAZINE, 24 IN. PAN. CAMERA	P0400.	111	1	AREA A2	72.0	1011.0	-22.0	8.0
MAGAZINE, 3 IN. MAP. CAMERA	P0401.	111	1	BAG, RETURN EQUIP (B1)	22.3	1050.0	-27.0	39.0
EQUIP. XFR. SM-CM					94.30	1020.22	-23.18	15.33

3.1-112

SNA-8-D-027(111) REV 3

U
H
E
R
E
C
O
R
D
S
S
E
R
V
I
C
E
S

Amendment 110
7/19/71

TABLE 3.1-9.2 (CONTINUED)

MISSION J-1 TRANSFERRED CREW AND EQUIPMENT STORAGE LIST								
ITEMS OFFLOADED FROM CSM POST SIM EVA (27)						APOLLO COORDINATES		
DESCRIPTION	STOW. ITEM	REF	NO.	STORAGE LOCATION	WEIGHT	X-C.G.	Y-C.G.	Z-C.G.
BAG, JETTISON STORAGE ITEMS, FOOD + HYGIENE	BD147.	111	2	AREA A2	1.8	1011.0	-22.0	6.0
	CO10C.	111	1	AREA B1	30.8	1050.0	-27.0	39.0
EVA OFFLOAD					32.60	1047.85	-26.72	37.29

3.1-113

SNA-8-D-027(111) REV 3

TABLE 3.1-9.2 (CONTINUED)

MISSION J-1 TRANSFERRED CREW AND EQUIPMENT STORAGE LIST								
ITEMS REARRANGED IN CM PRIOR TO ENTRY (28)								
DESCRIPTION	STOW. ITEM	REF	NO.	STORAGE LOCATION	AFIGHT	APOLLO COORDINATES		
						X-C.G.	Y-C.G.	Z-C.G.
PGA CONTAINER	00300.	111	1	ON AFT BULKHEAD	7.7	1015.0	.0	-19.9
ITLSA - EV	R0211.	111		ON CREW RH STA	46.9	1043.0	24.5	-11.9
ITLSA - EV	R0211.	111		ON CREW CTR STA	46.9	1043.0	.0	-11.9
ITLSA - EV	R0212.	111		ON CREW LH STA	41.8	1043.0	-24.5	-11.9
GLOVES, IV PAIR	R0213.	111	1	ON CREW LH STA	2.0	1043.0	-24.5	-11.9
GLOVES, IV PAIR	R0213.	111	1	ON CREW RH STA	2.0	1043.0	24.5	-11.9
GLOVES, IV PAIR	R0213.	111	1	ON CREW CTR STA	2.0	1043.0	.0	-11.9
HELMET ASSY, PRESSURE	R0214.	111	1	ON CREW LH STA	2.6	1043.0	-24.5	-11.9
HELMET ASSY, PRESSURE	R0214.	111	1	ON CREW RH STA	2.6	1043.0	24.5	-11.9
HELMET ASSY, PRESSURE	R0214.	111	1	ON CREW CTR STA	2.6	1043.0	.0	-11.9
POCKET, SCISSORS (CMP)	R0218.	111	1	ON PGA LH CREW STA	.2	1043.0	-24.5	-11.9
POCKET, SCISSORS (CDR)	R0218.	111	1	ON PGA CT CREW STA	.2	1043.0	.0	-11.9
POCKET, SCISSORS (LMP)	R0218.	111	1	ON PGA RH CREW STA	.2	1043.0	24.5	-11.9
POCKET, CHECKLIST (CDR)	R0219.	111	1	ON PGA CT CREW STA	.2	1043.0	.0	-11.9
POCKET, CHECKLIST (LMP)	R0219.	111	1	ON PGA RH CREW STA	.2	1043.0	24.5	-11.9
POCKET, DATA (CDR)	R0220.	111	1	ON PGA CT CREW STA	.2	1043.0	.0	-11.9
POCKET, DATA (LMP)	R0220.	111	1	ON PGA RH CREW STA	.2	1043.0	24.5	-11.9
POCKET, CHECKLIST (CMP)	R0221.	111	1	ON PGA LH CREW STA	.2	1043.0	-24.5	-11.9
POCKET, DATA (CMP)	R0222.	111	1	ON PGA LH CREW STA	.2	1043.0	-24.5	-11.9
BAG, HELMET STORAGE	R1058.	115	1	IN CM PGA CONTAINER	1.4	1015.0	.0	-20.0
BAG, HELMET STORAGE	R1058.	115	1	IN CM PGA CONTAINER	1.4	1015.0	.0	-20.0
LUNAR EXTRAVEHICULAR VISOR	R1014.	115	1	IN CM PGA CONTAINER	5.6	1015.0	.0	-20.0
LUNAR EXTRAVEHICULAR VISOR	R1014.	115	1	IN CM PGA CONTAINER	5.6	1015.0	.0	-20.0
GLOVES, EV-PAIR	R1015.	111	1	IN CM PGA CONTAINER	2.9	1015.0	.0	-20.0
GLOVES, EV-PAIR	R1015.	111	1	IN CM PGA CONTAINER	2.9	1015.0	.0	-20.0
KIT, EMU MAINTENANCE	R1016.	115	1	IN CM PGA CONTAINER	.5	1015.0	.0	-20.0
CONTAINER, R12	00344.	115	1	RH GIRTH RING	2.7	1034.0	41.0	-21.0
FILTER, CABIN FAN	06395.	111	1	AREA U2	2.4	1033.0	-23.0	-50.0
WATER SYS ASSY, RETURN CONTIN.	06444.	111	1	IN CM PGA CONTAINER	9.0	1015.0	.0	-20.0
BAG, WATER/URINE CONTIN. ASSY	06445.		3	IN CM PGA CONTAINER	3.6	1015.0	.0	-20.0
RESTRAINT ASSY, SLEPP (RIGHT)	00322.	111	1	AFT UEB (RIGHT)	3.8	1018.0	23.0	-51.0
RESTRAINT ASSY, SLEPP (CENTER)	00324.	111	1	AFT UEB (RIGHT)	2.7	1018.0	23.0	-51.0

3.1-115

SNA-8-D-027(III) REV 3

TABLE 3.1-9.2 (CONTINUED)

MISSION J-1 TRANSFERRED CREW AND EQUIPMENT STORAGE LIST								
ITEMS REARRANGED IN CM PRIOR TO ENTRY (28)								
DESCRIPTION	STOW. ITEM	REF	NO.	STOWAGE LOCATION	WEIGHT	APOLLO COORDINATES		
						X-C.G.	Y-C.G.	Z-C.G.
SHIELD, HELMET PROTECTIVE	R0121.		1	IN CM PGA CONTAINER	.8	1015.0	.0	-20.0
CAP, O2 HOSE SCREEN	00378.		3	IN CM PGA CONTAINER	.3	1015.0	.0	-20.0
BAG, DECON, LUNAR SURFACE	TBD	111	1	BETWEEN PGA AND A9	.9	1014.0	.0	8.0
BAG, SAMPLE COLLECTION	0307A.	111	1	BETWEEN PGA AND A9	.5	1014.0	.0	8.0
SAMPLE COLLECTION BAG 3	G404R.	111	1	BETWEEN PGA AND A9	1.2	1014.0	.0	8.0
SAMPLES IN BAG 3	N/A	115	1	BETWEEN PGA AND A9	8.5	1014.0	.0	8.0
BAG, DECON LUNAR ROCK	0647C.	111	1	BETWEEN PGA AND A9	5.0	1014.0	.0	8.0
PLATE, REINFORCEMENT	06471.	111	1	BETWEEN PGA AND A9	1.5	1014.0	.0	8.0
CM EQUIP. RELOC. 5					255.10	1033.56	-1.48	-15.71

3.1-116

TABLE 3.1-9.2 (CONTINUED)

MISSION J-1 TRANSFERRED CREW AND EQUIPMENT STOWAGE LIST								
ITEMS REARRANGED IN CH PRIOR TO ENTRY (29)								
APOLLO COORDINATES								
DESCRIPTION	STOW. ITEM	REF	NO.	STOWAGE LOCATION	WEIGHT	X-C.G.	Y-C.G.	Z-C.G.
BAG, MOTION SICKNESS	A020A.	111	1	PGA CONTAINER	.1	1015.0	.0	-6.0
BAG, MOTION SICKNESS	A020B.	111	1	PGA CONTAINER	.1	1015.0	.0	-6.0
BAG, MOTION SICKNESS	A020A.	111	1	ON RH+CTR SLEEP REST	.1	1020.0	25.0	-22.0
ACCESSORY BAG	B0105.1	111	1	PGA CONTAINER	.3	1020.0	.0	2.0
ACCESSORY BAG	B0105.1	111	1	PGA CONTAINER	.3	1020.0	.0	2.0
ACCESSORY BAG	B0105.1	111	1	ON RH+CTR SLEEP REST	.3	1020.0	25.0	-22.0
JACKET ASSY, ICG	R0112.1	111	1	ON CREW RH STA	1.8	1043.0	24.5	-11.9
JACKET ASSY, ICG	R0112.1	111	1	ON CREW CTR STA	1.8	1043.0	.0	-11.9
JACKET ASSY, ICG	R0112.1	111	1	ON CREW LH STA	1.8	1043.0	-24.5	-11.9
TROUSER ASSY, ICG	R0112.2	111	1	ON CREW RH STA	1.8	1043.0	24.5	-11.9
TROUSER ASSY, ICG	R0112.2	111	1	ON CREW CTR STA	1.8	1043.0	.0	-11.9
TROUSER ASSY, ICG	R0112.2	111	1	ON CREW LH STA	1.8	1043.0	-24.5	-11.9
BOOT, RIGHT, ICG	R0112.3	111	1	ON CREW RH STA	.4	1043.0	24.5	-11.9
BOOT, RIGHT, ICG	R0112.3	111	1	ON CREW CTR STA	.4	1043.0	.0	-11.9
BOOT, RIGHT, ICG	R0112.3	111	1	ON CREW LH STA	.4	1043.0	-24.5	-11.9
BOOT, LEFT, ICG	R0112.4	111	1	ON CREW RH STA	.4	1043.0	24.5	-11.9
BOOT, LEFT, ICG	R0112.4	111	1	ON CREW CTR STA	.4	1043.0	.0	-11.9
BOOT, LEFT, ICG	R0112.4	111	1	ON CREW LH STA	.4	1043.0	-24.5	-11.9
SUBSYSTEM, FECAL CONTAINMENT	R0113.	111	1	AREA A2	.3	1011.0	-22.0	8.0
PAD, HEADREST	B0130.	117	1	ON COUCH (RH CREW STA	1.1	1043.0	24.5	-10.4
PAD, HEADREST	B0130.	117	1	ON COUCH (CTR CREW STA	1.1	1043.0	.0	-10.4
PAD, HEADREST	B0130.	117	1	ON COUCH (LH CREW STA	1.1	1043.0	-24.5	-10.4
HEEL RESTRAINT, L.H. AND R.H.	R0132.	117	1	ON CREW RH STA	1.2	1043.0	24.5	-11.9
HEEL RESTRAINT, L.H. AND R.H.	R0132.	117	1	ON CREW CTR STA	1.2	1043.0	.0	-11.9
HEEL RESTRAINT, L.H. AND R.H.	R0132.	117	1	ON CREW LH STA	1.2	1043.0	-24.5	-11.9
GLOVES, EV-(CMP)	B0150.	111	1	ON RH+CTR SLEEP REST	2.7	1020.0	25.0	-22.0
VEST, DUAL LIFE	R0202.	111	1	ON CREW	2.4	1047.2	.0	-23.4
VEST, DUAL LIFE	R0202.	111	1	ON CREW	2.4	1047.2	.0	-23.4
VEST, DUAL LIFE	R0202.	111	1	ON CREW	2.4	1047.2	.0	-23.4
UCTA	R0205.	111	1	PGA CONTAINER	.5	1015.0	.0	-6.0
UCTA	R0205.	111	1	PGA CONTAINER	.5	1015.0	.0	-6.0
UCTA	R0223.	111	1	ON RH+CTR SLEEP REST	.5	1020.0	25.0	-22.0

3.1-117

SNA-8-D-027(111) REV 3

TABLE 3.1-9.2 (CONTINUED)

MISSION J-1 TRANSFERRED CREW AND EQUIPMENT STORAGE LIST								
ITEMS REARRANGED IN CM PRIOR TO ENTRY (29)								
DESCRIPTION	STOW. ITEM	REF	NO.	STOWAGE LOCATION	HEIGHT	APOLLO COORDINATES		
						X-C.G.	Y-C.G.	Z-C.G.
PGA CONTAINER	00300.	111	1	AFT UER	7.7	1015.0	.0	-6.0
ITLSA - EV	R0211.	111		PGA CONTAINER	46.9	1015.0	.0	-6.0
ITLSA - EV	R0211.	111		PGA CONTAINER	46.9	1015.0	.0	-6.0
ITLSA - EV	R0212.	111		ON RH+CTR SLEEP REST	41.8	1020.0	25.0	-22.0
GLOVES, IV PAIR	R0213.	111	1	PGA CONTAINER	2.0	1020.0	.0	2.0
GLOVES, IV PAIR	R0213.	111	1	PGA CONTAINER	2.0	1020.0	.0	2.0
GLOVES, IV PAIR	R0213.	111	1	ON RH+CTR SLEEP REST	2.0	1020.0	25.0	-22.0
HELMET ASSY, PRESSURE	R0214.	111	1	PGA CONTAINER	2.6	1020.0	.0	2.0
HELMET ASSY, PRESSURE	R0214.	111	1	PGA CONTAINER	2.6	1020.0	.0	2.0
HELMET ASSY, PRESSURE	R0214.	111	1	ON RH+CTR SLEEP REST	2.6	1020.0	25.0	-22.0
POCKET, SCISSORS (CMP)	R0218.	111	1	ON CREW LH STA	.2	1043.0	-24.5	-11.9
POCKET, SCISSORS (CDR)	R0218.	111	1	ON CREW CTR STA	.2	1043.0	.0	-11.9
POCKET, SCISSORS (LMP)	R0218.	111	1	ON CREW RH STA	.2	1043.0	24.5	-11.9
POCKET, CHECKLIST (CDR)	R0219.	111	1	ON CREW CTR STA	.2	1043.0	.0	-11.9
POCKET, CHECKLIST (LMP)	R0219.	111	1	ON CREW RH STA	.2	1043.0	24.5	-11.9
POCKET, DATA (CDR)	R0220.	111	1	ON CREW CTR STA	.2	1043.0	.0	-11.9
POCKET, DATA (LMP)	R0220.	111	1	ON CREW RH STA	.2	1043.0	24.5	-11.9
POCKET, CHECKLIST (CMP)	R0221.	111	1	ON CREW LH STA	.2	1043.0	-24.5	-11.9
POCKET, DATA (CMP)	R0222.	111	1	ON CREW LH STA	.2	1043.0	-24.5	-11.9
BAG, HELMET STOWAGE	R1058.	115	1	PGA CONTAINER	1.4	1020.0	.0	2.0
BAG, HELMET STOWAGE	R1058.	115	1	PGA CONTAINER	1.4	1020.0	.0	2.0
LUNAR EXTRAVEHICULAR VISOR	R1014.	115	1	PGA CONTAINER	5.6	1020.0	.0	2.0
LUNAR EXTRAVEHICULAR VISOR	R1014.	115	1	PGA CONTAINER	5.6	1020.0	.0	2.0
GLOVES, EV-PAIR	R1015.	111	1	PGA CONTAINER	2.9	1020.0	.0	2.0
GLOVES, EV-PAIR	R1015.	111	1	PGA CONTAINER	2.9	1020.0	.0	2.0
KIT, EMU MAINTENANCE	R1016.	115	1	PGA CONTAINER	.5	1020.0	.0	2.0
CONTAINER, R12	00344.	115	1	AREA R3	2.7	1072.0	26.0	9.0
FILTER, CABIN FAN	06395.	111	1	AREA A1	2.4	1011.0	-21.0	-22.0
WATER SYS ASSY, RETURN CONTIN.	06444.	111	1	PGA CONTAINER	9.0	1015.0	.0	-6.0
BAG, WATER/URINE CONTIN. ASSY	06445.		3	PGA CONTAINER	3.6	1015.0	.0	-6.0
RESTRAINT ASSY, SLEEP (RIGHT)	00322.	111	1	ON TOP OF AREA AB	3.8	1020.0	25.0	-8.0
RESTRAINT ASSY, SLEEP (CENTER)	00324.	111	1	ON TOP OF AREA AB	2.7	1020.0	25.0	-8.0

3.1-118

SNA-8-D-027(111) REV 3

Amendment 110
7/19/71

TABLE 3.1-9.2 (CONTINUED)

MISSION J-1 TRANSFERRED CREW AND EQUIPMENT STORAGE LIST								
ITEMS REARRANGED IN CM PRIOR TO ENTRY (29)								
APOLLO COORDINATES								
DESCRIPTION	STOW. ITEM	REF	NO.	STORAGE LOCATION	WEIGHT	X-C.G.	Y-C.G.	Z-C.G.
SHIELD, HELMET PROTECTIVE	RC121.		1	PGA CONTAINER	.8	1015.0	.0	-6.0
CAP, O2 HOSE SCREEN	0037B.		3	PGA CONTAINER	.3	1015.0	.0	-6.0
BAG, DECON, LUNAR SURFACE	TBD	111	1	IN PGA CONTAINER	.9	1020.0	.0	8.0
BAG, SAMPLE COLLECTION	0307A.	111	1	IN PGA CONTAINER	.5	1020.0	.0	8.0
SAMPLE COLLECTION BAG 3	G404A.	111	1	IN PGA CONTAINER	1.2	1020.0	.0	8.0
SAMPLES IN BAG 3	N/A	115	1	IN PGA CONTAINER	8.5	1020.0	.0	8.0
BAG, DECON LUNAR ROCK	0647C.	111	1	IN PGA CONTAINER	5.0	1020.0	.0	8.0
PLATE, REINFORCEMENT	06471.	111	1	IN PGA CONTAINER	1.5	1020.0	.0	8.0
CM EQUIP. RELOC. 5					755.10	1020.92	5.59	-8.23

3.1-119

SNA-8-D-027 (III) REV 3

TABLE 3.1-9.2 (CONTINUED)

CREW METABOLIC ACTIVITY

Event	Item	W	X	Y	Z
Pre EVA1	LiOH, Urine	5.4	252.0	0.0	41.0
	PLSS Charge	11.8	263.5	-20.6	14.9
	PLSS Charge	11.8	219.9	-1.3	44.5
	Food	-2.4	288.0	0.0	-24.0
	Subtotal	26.6	239.6	-9.7	36.8
Pre EVA2	LiOH, Urine	0.4	252.0	0.0	41.0
	Food	-2.5	288.0	0.0	-24.0
	Subtotal	24.5	234.9	-10.5	43.1
Pre EVA3	LiOH, Urine	2.1	252.0	0.0	41.0
	Food	-3.0	288.0	0.0	-24.0
	Subtotal	23.6	229.6	-10.9	51.5
Pre Depr.	Waste	-1.5	252.0	0.0	41.0
	Food	-0.5	288.0	0.0	-24.0
	PLSS Loss	-12.4	263.5	-20.6	14.9
	PLSS Loss	-12.4	219.9	-1.3	44.5
	Subtotal	-3.2	342.7	-4.1	-133.9

3.1-120

SNA-8-D-027 (III) REV 3

U
N
I
T
E
D
S
T
A
T
E
S
O
F
A
M
E
R
I
C
A

Amendment 111
7/22/71

TABLE 3.1-9.2 (CONTINUED)

LM EMERGENCY LIFTOFF								
ITEMS REARRANGED IN ASCENT STAGE PRE SEVA						LM COORDINATES		
DESCRIPTION	STOR. ITEM	REF	NO.	STORAGE LOCATION	WEIGHT	X-C.G.	Y-C.G.	Z-C.G.
JETTISON BAG	B1027.		1	A1G	.9	257.5	-20.0	-10.0
GLOVES,EV			1	CDR HELMET BAG(F10)	2.9	221.0	-10.0	51.0
GLOVES,EV			1	F0	2.9	221.0	10.0	51.0
SLEEP RESTRAINTS	B1061.		2	ON FLOOR - PLSS	5.2	226.5	-1.5	50.5
LEVA	B1014.		1	CDR HELMET BAG(F10)	5.6	221.0	-10.0	51.0
LEVA	B1014.		1	F0	5.6	221.0	10.0	51.0
HELMET STORAGE BAG	B1050.		1	CDR HELMET BAG(F10)	1.4	221.0	-10.0	51.0
HELMET STORAGE BAG	B1050.		1	F0	1.4	221.0	10.0	51.0
HELMET BAG	T90		1	F0	1.5	221.0	10.0	51.0
PLSS	B1025.		1	FLOOR	80.2	219.9	-1.3	44.5
500MM LENS/CAMERA ASSY	A1046.		1	AFT ENG CAN(A14A)	9.1	239.6	-5.5	-14.8
PURSE AND CONTENTS	T80		1	ISA (A10)	.9	270.3	-15.0	19.0
EMU MAINTENANCE KIT	B1016.		1	F0	.5	221.0	10.0	51.0
70MM CAMERA/LENS ASSY	A1016.		1	F7C	6.3	242.0	30.0	41.0
PRE SEVA REARRANGE					132.90	223.38	.54	40.97

3.1-120.1

SNA-8-D-027(III) REV 3

U
N
I
T
E
D
S
T
A
T
E
S
O
F
A
M
E
R
I
C
A

Amendment 111
7/22/71

TABLE 3.1-9.2 (CONTINUED)

LM EMERGENCY LIFTOFF								
ITEMS REARRANGED IN ASCENT STAGE PRE SEVA								
DESCRIPTION	STOW. ITEM	REF	NO.	STOWAGE LOCATION	WEIGHT	LM COORDINATES		
						X-C.G.	Y-C.G.	Z-C.G.
JETTISON BAG	B1027.		1	ISA (A3)	.9	280.0	.0	-10.0
GLOVES, EV			1	FLOOR	2.9	221.0	.0	5.1
GLOVES, EV			1	FLOOR	2.9	221.0	.0	5.1
SLEEP RESTRAINTS	B1061.		2	ISA (A3)	5.2	280.0	.0	-10.0
LEVA	B1014.		1	FLOOR	5.6	221.0	.0	5.1
LEVA	B1014.		1	FLOOR	5.6	221.0	.0	5.1
HELMET STORAGE BAG	B1058.		1	FLOOR	1.4	221.0	.0	5.1
HELMET STORAGE BAG	B1058.		1	FLOOR	1.4	221.0	.0	5.1
HELMET BAG	T80		1	ISA (A3)	1.5	280.0	.0	-10.0
PLSS	B1025.		1	FLOOR	92.7	219.9	-1.3	44.5
500MM LENS/CAMERA ASSY	A1046.		1	ISA (A3)	9.1	280.0	.0	-10.0
PURSE AND CONTENTS	T80		1	ISA (A3)	.9	280.0	.0	-10.0
EMU MAINTENANCE KIT	B1016.		1	ISA (A3)	.5	280.0	.0	-10.0
70MM CAMERA/LENS ASSY	A1016.		1	RHSSC	6.3	231.8	36.0	47.3
PRE SEVA REARRANGE					136.90	228.55	.78	31.72

3.1-120.2

SMA-8-D-027(III) REV 3

TABLE 3.1-9.2 (CONTINUED)

LM EMERGENCY LIFTOFF								
ITEMS REARRANGED IN ASCENT STAGE PRE EVA 1								
LM COORDINATES								
DESCRIPTION	STOW. ITEM	REF	NO.	STOWAGE LOCATION	WEIGHT	X-C.G.	Y-C.G.	Z-C.G.
JETTISON BAG	B1027.		1	RH CABIN FLOOR - FWD	.9	218.8	18.0	55.0
GLOVES, EV			1	FLOOR	2.9	221.0	.0	5.1
GLOVES, EV			1	FLOOR	2.9	221.0	.0	5.1
SRC/OPS ADAPTERS	03004.		1	RH CABIN FLOOR - FWD	2.5	218.8	18.0	55.0
SRC/OPS ADAPTERS	03004.		1	RH CABIN FLOOR - FWD	2.6	218.8	18.0	55.0
ARM RESTS	T8D		2	RH CABIN FLOOR - FWD	2.2	218.8	18.0	55.0
ARM RESTS	T8D		1	RH CABIN FLOOR - FWD	1.1	218.8	18.0	55.0
LION BRACKET (ECS)	03024.		1	RH CABIN FLOOR - FWD	.1	218.8	18.0	55.0
CONTAINER, BUDDY SLSS ASSY	03059.		1	ISA (A3)	3.8	280.0	.0	-10.0
RESEAU COVER, TAPE, LOOSE	A0123.		1	RH CABIN FLOOR - FWD	.2	218.8	18.0	55.0
ISS	T8D		1	RH CABIN FLOOR - FWD	1.0	218.8	18.0	55.0
LCG	B0107.		1	AFT ENG CAN (A14A)	4.3	239.6	-5.5	-14.8
OXYGEN PURGE SYSTEM	B1059.		1	F9	35.9	219.9	-1.3	44.5
OXYGEN PURGE SYSTEM	B1012.			F9	35.9	219.9	-1.3	44.5
LION CANISTER + STRAP (ECS)	03081.		1	RH CABIN FLOOR - FWD	9.4	218.8	18.0	55.0
SLEEP RESTRAINTS	B1061.		2	LOWER BAY LHSSC	5.2	228.0	-40.2	43.2
ICG	B1039.		2	AIL	8.8	281.0	-20.0	-8.5
LEVA	B1014.		1	FLOOR	5.6	221.0	.0	5.1
LEVA	B1014.		1	FLOOR	5.6	221.0	.0	5.1
HELMET STORAGE BAG	B1058.		1	FLOOR	1.4	221.0	.0	5.1
HELMET STORAGE BAG	B1058.		1	FLOOR	1.4	221.0	.0	5.1
HELMET BAG	T8D		1	ISA (A3)	1.5	280.0	.0	-10.0
RCU	B1001.		2	LM AFT MID-SECTION	10.2	257.5	-20.0	-18.0
PLSS	B1025.		1	DONNING STATION	100.5	252.4	-5.8	19.2
TOOL CARRIER	B1063.		1	ISA (A3)	1.5	280.0	.0	-10.0
SLEEP RESTRAINT ASSY STRAP	03082.		2	LOWER BAY LHSSC	.2	228.0	-40.2	43.2
TOOL CARRIER	B1064.		1	ISA (A3)	1.5	280.0	.0	-10.0
EQUIPMENT TRANSFER BAG	03018.		1	ISA (A3)	1.2	280.0	.0	-10.0
70 MM MAG (KK)	A0108.1		1	ISA (A3)	1.4	280.0	.0	-10.0
70 MM MAG (NN)	A0108.1		1	ISA (A3)	1.4	280.0	.0	-10.0
70MM MAGAZINE (OU)	A0108.1		1	ISA (A3)	1.4	280.0	.0	-10.0
70MM MAGAZINE (MM)	A0108.1		1	ISA (A3)	1.4	280.0	.0	-10.0

3.1-120.3

SNA-8-D-027(III) REV 3

N
H
E
L
I
C
O
P
T
E
R
L
I
F
T
O
F
F

U
N
I
T
E
D
S
T
A
T
E
S
O
F
A
M
E
R
I
C
A

TABLE 3.1-9.2 (CONTINUED)

LM EMERGENCY LIFTOFF									
ITEMS REARRANGED IN ASCENT STAGE PRE EVA 1									
DESCRIPTION	STOR. ITEM	REF	NO.	STORAGE LOCATION	WEIGHT	LM COORDINATES			
						X-C.G.	Y-C.G.	Z-C.G.	
70MM MAGAZINE (LL)	A0108.1		1	ISA (A3)	1.4	280.0	.0	-10.0	
16MM MAGAZINE (CC)	A0101.1		1	ISA (A3)	1.0	280.0	.0	-10.0	
16MM MAGAZINE (DD)	A0101.1		1	ISA (A3)	1.0	280.0	.0	-10.0	
16MM MAGAZINE (EE)	A0101.1		1	ISA (A3)	1.0	280.0	.0	-10.0	
500MM LENS/CAMERA ASSY	A1046.		1	ISA (A3)	9.1	280.0	.0	-10.0	
PURSE AND CONTENTS	TBD		1	ISA (A3)	.9	280.0	.0	-10.0	
EMU MAINTENANCE KIT	B1U16.		1	ISA (A3)	.5	280.0	.0	-10.0	
LUNAR SURFACE MAPS	A1008.J		1	ISA (A3)	.5	280.0	.0	-10.0	
MAP HOLDER	R1002.		1	ISA (A3)	.5	280.0	.0	-10.0	
70MM CAMERA/LENS ASSY	A1016.		1	RHSSC	6.3	231.8	36.0	47.3	
BUDDY SLSS ASSY	B1052.		1	ISA (A3)	7.3	280.0	.0	-10.0	
500MM LENS/CAMERA BAG	O3080.		1	ISA (A3)	4.4	280.0	.0	-10.0	
L.S.CONT.RETURN CONTAINER	G4016.		1	ISA (A3)	.8	280.0	.0	-10.0	
PRE EVA 1 REARRANG					290.60	244.01	-2.44	20.99	

3.1-120.4

SNA-8-D-027(III) REV 3

TABLE 3.1-9.2 (CONTINUED)

LM EMERGENCY LIFTOFF								
ITEMS REARRANGED IN ASCENT STAGE PRE EVA 1								
DESCRIPTION	STOW. ITEM	REF	NO.	STORAGE LOCATION	WEIGHT	LM COORDINATES		
						X-C.G.	Y-C.G.	Z-C.G.
JETTISON BAG	81027.		1	A1G	.9	257.5	-20.0	-18.0
GLOVES, EV			1	CDR HELMET BAG(F10)	2.9	221.0	-18.0	51.0
GLOVES, EV			1	F8	2.9	221.0	18.0	51.0
SRC/OPS ADAPTERS	03004.		1	LH AFT MID-SEC.	2.5	261.6	-25.6	-6.0
SRC/OPS ADAPTERS	03004.		1	LH AFT MID-SEC.	2.6	261.6	-25.6	-6.0
ARM RESTS	T8D		2	CREW STATION	2.2	251.4	3.5	56.3
ARM RESTS	T8D		1	CREW STATION	1.1	251.4	3.5	56.3
LION BRACKET (ECS)	03024.		1	A10	.1	250.0	8.0	-11.8
CONTAINER, BUDDY SLSS ASSY	03059.		1	ON PLUS 227 BULKHEAD	3.8	221.8	-1.0	29.5
RESEAU COVER, TAPE, LOOSE	A0123.		1	AFT ENG CAN(A14A)	.2	239.6	-5.5	-14.8
ISS	T8D		1	A1H	1.0	265.9	-20.0	-18.0
LCG	B0107.		1	ISA (A3)	4.3	280.0	.0	-10.0
OXYGEN PURGE SYSTEM	B1059.		1	A1F	35.9	257.4	-20.7	-6.0
OXYGEN PURGE SYSTEM	B1012.			A1E	35.9	265.9	-20.7	-6.0
LION CANISTER + STRAP (ECS)	03081.		1	A10	9.4	250.0	8.0	-11.8
SLEEP RESTRAINTS	B1061.		2	ON FLOOR - PLSS	5.2	226.5	-1.5	50.5
ICG	B1039.		2	A1C	8.8	240.5	-18.0	13.3
LEVA	B1014.		1	CDR HELMET BAG(F10)	5.6	221.0	-18.0	51.0
LEVA	B1014.		1	F8	5.6	221.0	18.0	51.0
HELMET STORAGE BAG	B1058.		1	CDR HELMET BAG(F10)	1.4	221.0	-18.0	51.0
HELMET STORAGE BAG	B1058.		1	F8	1.4	221.0	18.0	51.0
HELMET BAG	T8D		1	F8	1.5	221.0	18.0	51.0
RCU	B1001.		2	A12	10.2	272.0	.0	-18.0
PLSS	B1025.		1	FLOOR	100.5	219.9	-1.3	44.5
TOOL CARRIER	B1063.		1	ON PLUS 227 BULKHEAD	1.5	221.8	-1.0	29.5
SLEEP RESTRAINT ASSY STRAP	03082.		2	ON FLOOR - PLSS	.2	226.5	-1.5	50.5
TOOL CARRIER	B1064.		1	ON PLUS 227 BULKHEAD	1.5	221.8	-1.0	29.5
EQUIPMENT TRANSFER BAG	03018.		1	ON PLUS 227 BULKHEAD	1.2	221.8	-1.0	29.5
70 MM MAG (KK)	A0108.1		1	F7D	1.4	238.0	38.0	38.4
70 MM MAG (NN)	A0108.1		1	F7D	1.4	238.0	38.0	38.4
70MM MAGAZINE (OO)	A0108.1		1	F7D	1.4	238.0	38.0	38.4
70MM MAGAZINE (MM)	A0108.1		1	F7D	1.4	238.0	38.0	38.4

3.1-120.5

SNA-8-D-027(III) REV 3

TABLE 3.1-9.2 (CONTINUED)

LM EMERGENCY LIFTOFF								
ITEMS REARRANGED IN ASCENT STAGE PRE EVA 1								
DESCRIPTION	STOW. ITEM	REF	NO.	STORAGE LOCATION	WEIGHT	LM COORDINATES		
						X-C.G.	Y-C.G.	Z-C.G.
70MM MAGAZINE (LL)	A0100.1		1	AFT OF RHSSC	1.4	241.0	38.0	53.4
16MM MAGAZINE (CC)	A0101.1		1	RHSSC	1.0	231.8	36.0	47.3
16MM MAGAZINE (DD)	A0101.1		1	RHSSC	1.0	231.8	36.0	47.3
16MM MAGAZINE (EE)	A0101.1		1	RHSSC	1.0	231.8	36.0	47.3
500MM LENS/CAMERA ASSY	A1046.		1	AFT ENG CAN(A14A)	9.1	239.6	-5.5	-14.8
PURSE AND CONTENTS	T8D		1	ISA (A1D)	.9	270.3	-15.0	19.0
EMU MAINTENANCE KIT	B1016.		1	F8	.5	221.0	18.0	51.0
LUNAR SURFACE MAPS	A1008.3		1	FLIGHT DATA FILE	.5	282.2	-18.5	12.2
MAP HOLDER	R1002.		1	FLIGHT DATA FILE	.5	282.2	-18.5	12.2
70MM CAMERA/LENS ASSY	A1016.		1	F7C	6.3	242.8	38.0	41.0
BUDDY SLSS ASSY	B1052.		1	ON PLUS 227 BULKHEAD	7.3	221.8	-1.0	29.5
500MM LENS/CAMERA BAG	03080.		1	AFT ENG CAN(A14A)	4.4	239.6	-5.5	-19.8
L.S.CONT.RETURN CONTAINER	G4016.		1	A1G	.8	257.5	-20.0	-18.0
PRE EVA 1 REARRANG					290.60	238.68	-4.66	21.61

3.1-120.6

SMA-8-D-027(III) REV 3

U
M
E
R
I
C
A
N
S
P
A
C
E
A
G
E
N
C
Y

N
 U
 M
 E
 R
 I
 C
 A
 L
 I
 D
 E
 N
 T
 I
 F
 I
 C
 A
 T
 I
 O
 N

TABLE 3.1-9.2 (CONTINUED)

Amendment 111
7/22/71

LM EMERGENCY LIFTOFF								
ITEMS OFFLOADED AT LUNAR SITE DURING EVA 1								
						LM COORDINATES		
DESCRIPTION	STOW. ITEM	REF	NO.	STORAGE LOCATION	WEIGHT	X-C.G.	Y-C.G.	Z-C.G.
JETTISON BAG	B1027.		1	A1G	.9	257.5	-20.0	-18.0
SRC/OPS ADAPTERS	03004.		1	LH AFT MID-SEC.	2.5	261.6	-25.6	-6.0
SRC/OPS ADAPTERS	03004.		1	LH AFT MID-SEC.	2.6	261.6	-25.6	-6.0
ARM RESIS	T8D		2	CREW STATION	2.2	251.4	3.5	56.3
ARM RESIS	T8D		1	CREW STATION	1.1	251.4	3.5	56.3
LION BRACKET (ECS)	03024.		1	A1U	.1	250.0	8.0	-11.8
RESEAU COVER, TAPE, LOOSE	A0123.		1	AFT ENG CAN(A14A)	.2	239.6	-5.5	-14.8
PADDING(FROM 500MM LENS/CAMERA	T8D		1	AFT ENG CAN(A14A)	T8D	239.6	-5.5	-14.8
LION CANISTER + STRAP (ECS)	03081.		1	A1U	9.4	250.0	8.0	-11.8
DISPENSER BRACKETS BAG	T8D		1	F1E	T8D	237.9	-33.6	55.0
SUN COMPASS	T8D		1	F1E	T8D	237.9	-33.6	55.0
EQUIPMENT TRANSFER BAG	03018.		1	ON PLUS Z27 BULKHEAD	1.2	221.8	-1.0	29.5
7U MM MAG (KK)	A0108.1		1	F7D	1.4	238.0	38.0	38.4
7U MM MAG (NN)	A0108.1		1	F7D	1.4	238.0	38.0	38.4
7UHM MAGAZINE (OU)	A0108.1		1	F7D	1.4	238.0	38.0	38.4
7UHM MAGAZINE (HM)	A0108.1		1	F7D	1.4	238.0	38.0	38.4
7UHM MAGAZINE (LL)	A0108.1		1	AFT OF RHSSC	1.4	241.0	38.0	53.4
16MM MAGAZINE (CC)	A0101.1		1	RHSSC	1.0	231.8	36.0	47.3
16MM MAGAZINE (DD)	A0101.1		1	RHSSC	1.0	231.8	36.0	47.3
16MM MAGAZINE (EE)	A0101.1		1	RHSSC	1.0	231.8	36.0	47.3
500MM LENS/CAMERA ASSY	A1046.		1	AFT ENG CAN(A14A)	9.1	239.6	-5.5	-14.8
LUNAR SURFACE MAPS	A1008.3		1	FLIGHT DATA FILE	.5	282.2	-18.5	12.2
MAP HOLDER	R1002.		1	FLIGHT DATA FILE	.5	282.2	-18.5	12.2
7UHM CAMERA/LENS ASSY	A1016.		1	F7C	4.3	242.8	38.0	41.0
BUDDY SLSS ASSY	B1052.		1	ON PLUS Z27 BULKHEAD	7.3	221.8	-1.0	29.5
500MM LENS/CAMERA BAG	03080.		1	AFT ENG CAN(A14A)	4.4	239.6	-5.5	-14.8
LEC BAG	B1020.1		1	F7N	.2	238.0	38.0	53.1
CONVEYOR ASSY	B1020.2		1	F7N	1.3	238.0	38.0	53.1
DEPLOYMENT BAG	B1020.3		1	F7N	.1	238.0	38.0	53.1
L.S.CONT.RETURN CONTAINER	G4016.		1	A1G	.8	257.5	-20.0	-18.0
EVA 1 OFFLOAD					60.73	242.22	8.14	13.97

3.1-120.7

SMA-8-D-027(III) REV 3

TABLE 3.1-9.2 (CONTINUED)

LM EMERGENCY LIFTOFF								
ITEMS UNLOADED AT LUNAR SITE DURING EVA 1						LM COORDINATES		
DESCRIPTION	STOW. ITEM	REF	NO.	STORAGE LOCATION	WEIGHT	X-C.G.	Y-C.G.	Z-C.G.
L10M CARTRIDGE (PLSS)	B1002.		1	AGAINST HATCH-FLOOR	6.9	229.5	.0	54.6
L10M CARTRIDGE (PLSS)	B1002.		1	A1B	6.9	263.5	-20.6	14.9
PLSS BATTERY	B1004.		1	AGAINST HATCH-FLOOR	8.4	229.5	.0	54.6
PLSS BATTERY	B1004.		1	A1B	8.4	263.5	-20.6	14.9
L10M CANISTER + STRAP (ECS)	03081.		1	A10	9.4	250.0	8.0	-11.8
EQUIPMENT TRANSFER BAG	03018.		1	RH CABIN FLOOR - FWD	1.2	218.8	18.0	55.0
70 MM MAG (KK)	A0108.1		1	F7D	1.4	238.0	38.0	38.4
70 MM MAG (NN)	A0108.1		1	F7D	1.4	238.0	38.0	38.4
70MM MAGAZINE (OO)	A0108.1		1	RH CABIN FLOOR - FWD	1.4	218.8	18.0	55.0
70MM MAGAZINE (MM)	A0108.1		1	AFT OF RHSSC	1.4	241.0	38.0	53.4
70MM MAGAZINE (LL)	A0108.1		1	F7P	1.4	241.0	38.0	53.4
16MM MAGAZINE (CC)	A0101.1		1	RHSSC	1.0	231.8	36.0	47.3
16MM MAGAZINE (DO)	A0101.1		1	RHSSC	1.0	231.8	36.0	47.3
16MM MAGAZINE (EE)	A0101.1		1	RHSSC	1.0	231.8	36.0	47.3
LUNAR SURFACE MAPS	A1008.3		1	RH CABIN FLOOR - FWD	.5	218.8	18.0	55.0
70MM CAMERA/LENS ASSY	A1016.		1	RH CABIN FLOOR - FWD	6.3	218.8	18.0	55.0
70MM CAMERA ASSY	A1015.		1	RH CABIN FLOOR - FWD	6.5	218.8	18.0	55.0
CSRC AND SAMPLES	G4016.		1	ISA (A3)	2.7	280.0	.0	-10.0
FOOD PACKAGE	C1002.		1	MINUS Z27 BULKHEAD	4.1	288.0	.0	-24.0
SCB 1, SCB 1 AND SAMPLES	04003.		1	A1F	40.0	257.4	-20.7	-6.0
SCB 3 AND SAMPLES + CONE TUBES	03078.		1	LOWER MID-SECTION	16.2	240.5	-18.0	13.3
SCB 4 AND SAMPLES	03078.		1	LOWER BAY RHSSC	16.8	238.0	38.0	42.7
COVER BAG 2	03078.		1	ISA (A3)	.6	280.0	.0	-10.0
COVER BAG 6	03078.		1	ISA (A3)	.6	280.0	.0	-10.0
COVER BAG 7	03078.		1	LOWER BAY LHSSC	.6	228.0	-40.2	43.2
COVER BAG 8	03078.		1	AFT ENG CAN(A14A)	.6	239.6	-5.5	-14.8
EVA 1 UNLOAD					146.70	246.44	-0.97	19.08

3.1-120.8

SMA-8-D-027(III) REV 3

U
N
I
T
E
D
S
T
A
T
E
S
O
F
A
M
E
R
I
C
A

TABLE 3.1-9.2 (CONTINUED)

LM EMERGENCY LIFTOFF								
ITEMS REARRANGED IN ASCENT STAGE PRE EVA 2								
DESCRIPTION				LM COORDINATES				
	STON. ITEM	REF	NO.	STORAGE LOCATION	WEIGHT	X-C.G.	Y-C.G.	Z-C.G.
GLOVES, EV			1	CDR HELMET BAG(F10)	2.9	221.0	-18.0	51.0
GLOVES, EV			1	FB	2.9	221.0	18.0	51.0
L10M CARTRIDGE (PLSS)	B1002.		1	AGAINST HATCH-FLOOR	6.9	229.5	.0	54.6
L10M CARTRIDGE (PLSS)	B1002.		1	A1B	6.9	263.5	-20.6	14.9
CONTAINER, BUDDY SLSS ASSY	03059.		1	ON PLUS Z27 BULKHEAD	3.8	221.8	-1.0	29.5
ISS	T8D		1	A1H	1.0	265.9	-20.0	-18.0
URINE BAGS	T8D		1	F1F	.3	235.5	-37.6	46.6
PLSS BATTERY	B1004.		1	AGAINST HATCH-FLOOR	8.4	229.5	.0	54.6
PLSS BATTERY	B1004.		1	A1B	8.4	263.5	-20.6	14.9
LCG	B0107.		1	ISA (A3)	4.3	280.0	.0	-10.0
OXYGEN PURGE SYSTEM	B1059.		1	A1F	35.9	257.4	-20.7	-6.0
OXYGEN PURGE SYSTEM	B1012.		1	A1E	35.9	265.9	-20.7	-6.0
HAMMOCK ASSY.	03048.		1	FIG	4.0	228.0	-40.2	43.2
HAMMOCK ASSY.	03050.		1	FIG	3.9	228.0	-40.2	43.2
SLEEP RESTRAINTS	B1061.		2	ON FLOOR - PLSS	5.2	226.5	-1.5	50.5
ICG	B1039.		2	A1C	8.8	240.5	-18.0	13.3
LEVA	B1014.		1	CDR HELMET BAG(F10)	5.6	221.0	-18.0	51.0
LEVA	B1014.		1	FB	5.6	221.0	18.0	51.0
HELMET STORAGE BAG	B1058.		1	CDR HELMET BAG(F10)	1.4	221.0	-18.0	51.0
HELMET STORAGE BAG	B1058.		1	FB	1.4	221.0	18.0	51.0
HELMET BAG	T8D		1	FB	1.5	221.0	18.0	51.0
RCU	B1001.		2	A1Z	10.2	272.0	.0	-18.0
PLSS	B1025.		1	FLOOR	100.5	219.9	-1.3	44.5
TOOL CARRIER	B1063.		1	ON PLUS Z27 BULKHEAD	1.5	221.8	-1.0	29.5
TOOL CARRIER	B1064.		1	ON PLUS Z27 BULKHEAD	1.5	221.8	-1.0	29.5
EQUIPMENT TRANSFER BAG	03018.		1	RH CABIN FLOOR - FWD	1.2	218.8	18.0	55.0
70MM MAGAZINE (00)	A0108.1		1	RH CABIN FLOOR - FWD	1.4	218.8	18.0	55.0
70MM MAGAZINE (MM)	AU108.1		1	AFT OF RHSSC	1.4	241.0	38.0	53.4
PURSE AND CONTENTS	T8D		1	ISA (A1D)	.9	270.3	-15.0	19.0
EMU MAINTENANCE KIT	B1016.		1	FR	.5	221.0	18.0	51.0
LUNAR SURFACE MAPS	A1008.3		1	RH CABIN FLOOR - FWD	.5	218.8	18.0	55.0
70MM CAMERA/LENS ASSY	A1016.		1	RH CABIN FLOOR - FWD	6.3	218.8	18.0	55.0

3.1-120.9

SNA-8-D-027(III) REV 3

U
 N
 I
 T
 E
 D
 S
 T
 A
 T
 E
 S
 U
 N
 I
 T
 E
 D
 S
 T
 A
 T
 E
 S

TABLE 3.1-9.2 (CONTINUED)

Amendment 111
7/22/71

LM EMERGENCY LIFTOFF								
ITEMS REARRANGED IN ASCENT STAGE PRE EVA 2								
DESCRIPTION	STOW. ITEM	REF	NO.	STOWAGE LOCATION	WEIGHT	LM COORDINATES		
						X-C.G.	Y-C.G.	Z-C.G.
7MM CAMERA ASSY	A1015.		1	RH CABIN FLOOR - FWD	6.5	218.0	18.0	55.0
7MM MAGAZINE (PP)	A0108.1		1	AFT ENG COVER	1.4	243.7	-5.5	-14.8
7MM MAGAZINE (QQ)	A0108.1		1	AFT ENG COVER	1.4	243.7	-5.5	-14.8
7MM MAGAZINE (RR)	A0108.1		1	AFT ENG COVER	1.4	243.7	-5.5	-14.8
16MM MAGAZINE (FF)	A0101.1		1	RHSSC	1.0	231.8	36.0	47.3
16MM MAGAZINE (GG)	A0101.1		1	RHSSC	1.0	231.8	36.0	47.3
FOOD PACKAGE	C1002.		1	MINUS 227 BULKHEAD	4.1	288.0	.0	-24.0
PRE EVA 2 REARRANG					297.70	238.14	-6.86	26.23

3.1-120.10

SNA-8-D-027(III) REV 3

N
 U
 M
 E
 R
 I
 C
 A
 L
 I
 D
 E
 N
 T
 I
 F
 I
 C
 A
 T
 I
 O
 N

Amendment 111
7/22/71

TABLE 3.1-9.2 (CONTINUED)

LM EMERGENCY LIFTOFF								
ITEMS OFFLOADED AT LUNAR SITE DURING EVA 2								
						LM COORDINATES		
DESCRIPTION	STOW. ITEM	REF	NO.	STOWAGE LOCATION	WEIGHT	X-C.G.	Y-C.G.	Z-C.G.
L10H CARTRIDGE (PLSS)	B1002.		1	AGAINST HATCH-FLOOR	6.9	229.5	.0	54.6
L10H CARTRIDGE (PLSS)	B1002.		1	A1B	6.9	263.5	-20.6	14.9
CONTAINER, HUDDY SLSS ASSY	O3059.		1	ON PLUS 227 BULKHEAD	3.8	221.8	-1.0	29.5
URINE BAGS	TBD		1	F1F	.3	235.5	-37.6	46.6
PLSS BATTERY	B1004.		1	AGAINST HATCH-FLOOR	8.4	229.5	.0	54.6
PLSS BATTERY	B1004.		1	A1B	8.4	263.5	-20.6	14.9
EQUIPMENT TRANSFER BAG	O3018.		1	RH CABIN FLOOR - FWD	1.2	218.8	18.0	55.0
70MM MAGAZINE (OO)	A0108.1		1	RH CABIN FLOOR - FWD	1.4	218.8	18.0	55.0
70MM MAGAZINE (HM)	A0108.1		1	AFT OF RHSSC	1.4	241.0	38.0	53.4
LUNAR SURFACE MAPS	A1008.3		1	RH CABIN FLOOR - FWD	.5	218.8	18.0	55.0
70MM CAMERA/LENS ASSY	A1016.		1	RH CABIN FLOOR - FWD	6.3	218.8	18.0	55.0
70MM CAMERA ASSY	A1015.		1	RH CABIN FLOOR - FWD	6.5	218.8	18.0	55.0
70MM MAGAZINE (PP)	A0108.1		1	AFT ENG COVER	1.4	243.7	-5.5	-14.8
70MM MAGAZINE (QB)	A0108.1		1	AFT ENG COVER	1.4	243.7	-5.5	-14.8
70MM MAGAZINE (RR)	A0108.1		1	AFT ENG COVER	1.4	243.7	-5.5	-14.8
16MM MAGAZINE (FF)	A0101.1		1	RHSSC	1.0	231.8	36.0	47.3
16MM MAGAZINE (GG)	A0101.1		1	RHSSC	1.0	231.8	36.0	47.3
16MM MAGAZINE (HH)	A0101.1		1	ISA (A3)	1.0	280.0	.0	-10.0
EVA 2 OFFLOAD					59.20	237.16	.98	36.51

3.1-120.13

SMA-8-D-027(III) REV 3

TABLE 3.1-9.2 (CONTINUED)

LM EMERGENCY LIFTOFF									
ITEMS UNLOADED AT LUNAR SITE DURING EVA 2									
DESCRIPTION	STOW. ITEM	REF	NO.	STOWAGE LOCATION	WEIGHT	LM COORDINATES			
						X-C.G.	Y-C.G.	Z-C.G.	
LION CARTRIDGE (PLSS)	B1002.		1	AGAINST HATCH-FLOOR	6.9	229.5	.0	54.6	
LION CARTRIDGE (PLSS)	B1002.		1	A1B	6.9	263.5	-20.6	14.9	
PLSS BATTERY	B1004.		1	AGAINST HATCH-FLOOR	8.4	229.5	.0	54.6	
PLSS BATTERY	R1004.		1	A1B	8.4	263.5	-20.6	14.9	
EQUIPMENT TRANSFER BAG	0301B.		1	RH CABIN FLOOR - FWD	1.2	218.8	18.0	55.0	
70MM MAGAZINE (OQ)	A010A.1		1	F7D	1.4	238.0	38.0	38.4	
70MM MAGAZINE (AM)	A010B.1		1	RH CABIN FLOOR - FWD	1.4	218.8	18.0	55.0	
LUNAR SURFACE MAPS	A100B.3		1	RH CABIN FLOOR - FWD	.5	218.8	18.0	55.0	
70MM CAMERA/LENS ASSY	A1016.		1	RH CABIN FLOOR - FWD	6.3	218.8	18.0	55.0	
70MM CAMERA ASSY	A1015.		1	RH CABIN FLOOR - FWD	6.5	218.8	18.0	55.0	
70MM MAGAZINE (PP)	A010B.1		1	A1C	1.4	240.5	-18.0	13.3	
70MM MAGAZINE (QQ)	A010B.1		1	A1C	1.4	240.5	-18.0	13.3	
70MM MAGAZINE (RN)	A010B.1		1	A1C	1.4	240.5	-18.0	13.3	
16MM MAGAZINE (FF)	A0101.1		1	RHSSC	1.0	231.8	36.0	47.3	
16MM MAGAZINE (GG)	A0101.1		1	RHSSC	1.0	231.8	36.0	47.3	
16MM MAGAZINE (HH)	A0101.1		1	ISA (A3)	1.0	280.0	.0	-10.0	
FOOD PACKAGE	C1002.			MINUS 227 BULKHEAD	3.9	288.0	.0	-24.0	
SRC 2, SCB 3 AND SAMPLES	G4004.		1	A1E	40.1	265.9	-20.7	-6.0	
SCB 4 + SCB 2 AND SAMPLES	G4048.		1	ISA (A3)	19.4	280.0	.0	-10.0	
EVA 2 UNLOAD					118.50	255.92	-6.83	13.53	

3.1-120.14

SMA-8-D-027(III) REV 3

U
 N
 I
 T
 E
 D
 S
 T
 A
 T
 E
 S
 P
 E
 C
 I
 F
 I
 C
 A
 T
 I
 O
 N
 S

TABLE 3.1-9.2 (CONTINUED)

LM EMERGENCY LIFTOFF								
ITEMS REARRANGED IN ASCENT STAGE PRE EVA 3								
LM COORDINATES								
DESCRIPTION	STOR. ITEM	REF	NO.	STORAGE LOCATION	WEIGHT	X-C.G.	Y-C.G.	Z-C.G.
JETTISON BAG	B1027.		1	A1G	.9	257.5	-20.0	-18.0
GLOVES, EV			1	CDR HELMET BAG (F10)	2.9	221.0	-18.0	51.0
GLOVES, EV			1	F8	2.9	221.0	18.0	51.0
ISS	TBD		1	A1H	1.0	265.9	-20.0	-18.0
URINE BAGS	TBD		1	F1F	.3	235.5	-37.6	46.6
LCG ADAPTERS	B1036.		2	F7E	.4	243.2	38.0	31.2
URINE RECEPTACLE	03039.		1	F1C	.6	242.5	-35.6	38.5
LCG	B0107.		1	ISA (A3)	4.3	280.0	.0	-10.0
OXYGEN PURGE SYSTEM	B1059.		1	A1F	35.9	257.4	-20.7	-6.0
OXYGEN PURGE SYSTEM	B1012.		1	A1E	35.9	265.9	-20.7	-6.0
USED TOWELS	B1043.		2	F1G	.2	228.0	-40.2	43.2
HAMMOCK ASSY.	03048.		1	F1G	4.0	228.0	-40.2	43.2
HAMMOCK ASSY.	03050.		1	F1G	3.9	228.0	-40.2	43.2
SLEEP RESTRAINTS	B1061.		2	ON FLOOR - PLSS	5.2	226.5	-1.5	50.5
ICG	B1039.		2	A1C	8.8	240.5	-18.0	13.3
LEVA	B1014.		1	CDR HELMET BAG (F10)	5.6	221.0	-18.0	51.0
LEVA	B1014.		1	F8	5.6	221.0	18.0	51.0
HELMET STORAGE BAG	B1058.		1	CDR HELMET BAG (F10)	1.4	221.0	-18.0	51.0
HELMET STORAGE BAG	B1058.		1	F8	1.4	221.0	18.0	51.0
HELMET BAG	TBD		1	F8	1.5	221.0	18.0	51.0
PLSS	B1025.		1	FLOOR	100.5	219.9	-1.3	44.5
TOOL CARRIER	B1063.		1	ON PLUS Z27 BULKHEAD	1.5	221.8	-1.0	29.5
TOOL CARRIER	B1064.		1	ON PLUS Z27 BULKHEAD	1.5	221.8	-1.0	29.5
EQUIPMENT TRANSFER BAG	03018.		1	RH CABIN FLOOR - FWD	1.2	218.8	18.0	55.0
7MM MAGAZINE (MM)	A0108.1		1	AFT OF RHSSC	1.4	241.0	38.0	53.4
PURSE AND CONTENTS	TBD		1	ISA (A1D)	.9	270.3	-15.0	19.0
EAU MAINTENANCE KIT	B1016.		1	F8	.5	221.0	18.0	51.0
LUNAR SURFACE MAPS	A1008.3		1	RH CABIN FLOOR - FWD	.5	218.8	18.0	55.0
7MM CAMERA/LENS ASSY	A1016.		1	RH CABIN FLOOR - FWD	6.3	218.8	18.0	55.0

3.1-120.15

SNA-8-D-027(III) REV 3

TABLE 3.1-9.2 (CONTINUED)

Amendment 111
7/22/71

LM EMERGENCY LIFTOFF								
ITEMS REARRANGED IN ASCENT STAGE PRE EVA 3								
LM COORDINATES								
DESCRIPTION	STOW. ITEM	REF	NO.	STOWAGE LOCATION	WEIGHT	X-C.G.	Y-C.G.	Z-C.G.
7MM CAMERA ASSY	A1015.		1	RH CABIN FLOOR - FWD	6.5	218.8	18.0	55.0
7MM MAGAZINE (PP)	A0108.1		1	A1C	1.4	240.5	-18.0	13.3
7MM MAGAZINE (QW)	A0108.1		1	A1C	1.4	240.5	-18.0	13.3
7MM MAGAZINE (RR)	A0108.1		1	A1C	1.4	240.5	-18.0	13.3
7U MM MAG (VV)	A0108.2		1	AFT OF RHSSC	1.4	241.0	38.0	53.4
PRE EVA 3 REARRANG					249.10	235.35	-7.44	27.96

3.1-120.16

SNA-8-D-027(III) REV 3

U
N
I
T
E
D
S
T
A
T
E
S
O
F
A
M
E
R
I
C
A

TABLE 3.1-9.2 (CONTINUED)

LM EMERGENCY LIFTOFF								
ITEMS REARRANGED IN ASCENT STAGE PRE EVA 3								
DESCRIPTION	STOR. ITEM	REF	NO.	STOWAGE LOCATION	WEIGHT	LM COORDINATES		
						X-C.G.	Y-C.G.	Z-C.G.
JETTISON BAG	B1027.		1	RH CABIN FLOOR - FWD	.9	218.8	18.0	55.0
GLOVES, EV			1	FLOOR	2.9	221.0	.0	5.1
GLOVES, EV			1	FLOOR	2.9	221.0	.0	5.1
ISS	TBD		1	RH CABIN FLOOR - FWD	1.0	218.8	18.0	55.0
URINE BAGS	TBD		1	RH CABIN FLOOR - FWD	.3	218.8	18.0	55.0
LCG ADAPTERS	B1036.		2	RH CABIN FLOOR - FWD	.4	218.8	18.0	55.0
URINE RECEPTACLE	U3039.		1	RH CABIN FLOOR - FWD	.6	218.8	18.0	55.0
LCG	B0107.		1	AIL	4.3	281.0	-20.0	-8.5
OXYGEN PURGE SYSTEM	B1059.		1	F9	35.9	219.9	-1.3	44.5
OXYGEN PURGE SYSTEM	B1012.		1	F9	35.9	219.9	-1.3	44.5
USED TOWELS	B1043.		2	RH CABIN FLOOR - FWD	.2	218.8	18.0	55.0
HAMMOCK ASSY.	O3048.		1	ISA (A3)	4.0	280.0	.0	-10.0
HAMMOCK ASSY.	O3050.		1	ISA (A3)	3.9	280.0	.0	-10.0
SLEEP RESTRAINTS	B1061.		2	ISA (A3)	5.2	280.0	.0	-10.0
ICG	B1039.		2	AIL	8.8	281.0	-20.0	-8.5
LEVA	B1014.		1	FLOOR	5.6	221.0	.0	5.1
LEVA	B1014.		1	FLOOR	5.6	221.0	.0	5.1
HELMET STORAGE BAG	B1058.		1	FLOOR	1.4	221.0	.0	5.1
HELMET STORAGE BAG	B1058.		1	FLOOR	1.4	221.0	.0	5.1
HELMET BAG	TBD		1	ISA (A3)	1.5	280.0	.0	-10.0
PLSS	B1025.		1	DONNING STATION	100.5	252.4	-5.8	19.2
TOOL CARRIER	B1063.		1	ISA (A3)	1.5	280.0	.0	-10.0
TOOL CARRIER	B1064.		1	ISA (A3)	1.5	280.0	.0	-10.0
EQUIPMENT TRANSFER BAG	O3018.		1	ISA (A3)	1.2	280.0	.0	-10.0
70MM MAGAZINE (MM)	A0108.1		1	ISA (A3)	1.4	280.0	.0	-10.0
PURSE AND CONTENTS	TBD		1	ISA (A3)	.9	280.0	.0	-10.0
EHU MAINTENANCE KIT	B1016.		1	ISA (A3)	.5	280.0	.0	-10.0
LUNAR SURFACE MAPS	A1008.3		1	ISA (A3)	.5	280.0	.0	-10.0
70MM CAMERA/LENS ASSY	A1016.		1	ISA (A3)	6.3	280.0	.0	-10.0

3.1-120.17

SNA-8-D-027 (III) REV 3

TABLE 3.1-9.2 (CONTINUED)

LM EMERGENCY LIFTOFF								
ITEMS OFFLOADED AT LUNAR SITE DURING EVA 3								
DESCRIPTION	STOW. ITEM	REF	NO.	STOWAGE LOCATION	WEIGHT	LM COORDINATES		
						X-C.G.	Y-C.G.	Z-C.G.
JETTISON BAG	B1027.		1	A1G	.9	257.5	-20.0	-18.0
L10M CARTRIDGE (PLSS)	B1002.		1	AGAINST HATCH-FLOOR	6.9	229.5	.0	54.6
L10M CARTRIDGE (PLSS)	B1002.		1	A1B	6.9	263.5	-20.6	14.9
DRINK BAGS	TBD		1	MINUS 227 BULKHEAD	1.0	288.0	.0	-24.0
URINE BAGS	TBD		1	F1F	.3	235.5	-37.6	46.6
PLSS BATTERY	B1004.		1	AGAINST HATCH-FLOOR	8.4	229.5	.0	54.6
PLSS BATTERY	B1004.		1	A1B	8.4	263.5	-20.6	14.9
LCG ADAPTERS	B1036.		2	F7E	.4	243.2	38.0	31.2
URINE RECEPTACLE	03039.		1	F1C	.6	242.5	-35.6	38.5
LCG	B0107.		1	ISA (A3)	4.3	280.0	.0	-10.0
L10M CANISTER + STRAP (ECS)	03081.		1	A1D	9.4	250.0	8.0	-11.8
USED TOWELS	B1043.		2	F1G	.2	228.0	-40.2	43.2
HAMMOCK ASSY.	03048.		1	F1G	4.0	228.0	-40.2	43.2
HAMMOCK ASSY.	03050.		1	F1G	3.9	228.0	-40.2	43.2
SLEEP RESTRAINTS	B1061.		2	ON FLOOR - PLSS	5.2	226.5	-1.5	50.5
ICG	B1039.		2	A1C (ICG ASSY)	8.8	240.5	-15.3	13.3
GARMENT, CONSTANT WEAR	B0208.		1	ON CREW (RH CREW STA)	.8	252.0	22.0	38.0
GARMENT, CONSTANT WEAR	B0208.		1	ON CREW (LH CREW STA)	.8	252.0	-22.0	44.0
EQUIPMENT TRANSFER BAG	03018.		1	RH CABIN FLOOR - FWD	1.2	218.8	18.0	55.0
70MM MAGAZINE (MH)	A0108.1		1	RH CABIN FLOOR - FWD	1.4	218.8	18.0	55.0
LUNAR SURFACE MAPS	A1008.3		1	RH CABIN FLOOR - FWD	.5	218.8	18.0	55.0
70MM CAMERA/LENS ASSY	A1016.		1	RH CABIN FLOOR - FWD	6.3	218.8	18.0	55.0
70MM CAMERA ASSY	A1015.		1	RH CABIN FLOOR - FWD	6.5	218.8	18.0	55.0
16MM MAGAZINE	A0101.1		1	ISA (A3)	1.0	280.0	.0	-10.0
16MM MAGAZINE	A0101.1		1	FS	1.0	286.0	17.8	66.6
70 MM MAG (SS)	A0108.2		1	AFT ENG COVER	1.4	243.7	-5.5	-14.8
70 MM MAG (TF)	A0108.2		1	AFT ENG COVER	1.4	243.7	-5.5	-14.8
70 MM MAG (UU)	A0108.2		1	AFT ENG COVER	1.4	243.7	-5.5	-14.8
70 MM MAG (VV)	A0108.2		1	AFT OF RHSSC	1.4	241.0	38.0	53.4
16 MM MAG (II)	A0101.2		1	AFT ENG COVER	1.0	243.7	-5.5	-14.8
16 MM MAG (JJ)	A0101.1		1	AFT ENG COVER	1.0	243.7	-5.5	-14.8
LCG	B0107.		1	ISA (A3)	4.3	280.0	.0	-10.0
EVA 3 OFFLOAD					101.00	243.28	-4.16	25.59

3.1-120.19

SNA-8-D-027 (III) REV 3

TABLE 3.1-9.2 (CONTINUED)

LM EMERGENCY LIFTOFF								
ITEMS UNLOADED AT LUNAR SITE DURING EVA 3								
LM COORDINATES								
DESCRIPTION	STOW. ITEM	REF	NO.	STOWAGE LOCATION	WEIGHT	X-C.G.	Y-C.G.	Z-C.G.
EQUIPMENT TRANSFER BAG	03018.		1	ISA (A3)	1.2	280.0	.0	-10.0
70MM MAGAZINE (MM)	A0108.1		1	AFT OF RHSSC	1.4	241.0	38.0	53.4
LUNAR SURFACE MAPS	A1008.3		1	A1A	.5	280.0	-19.0	13.5
16MM MAGAZINE	A0101.1		1	ISA (A3)	1.0	280.0	.0	-10.0
16MM MAGAZINE	A0101.1		1	FS	1.0	286.0	17.8	66.6
70 MM MAG (SS)	A0108.2		1	A1C	1.4	240.5	-18.0	13.3
70 MM MAG (TT)	A0108.2		1	A1C	1.4	240.5	-18.0	13.3
70 MM MAG (UU)	A0108.2		1	LOWER MID-SECTION	1.4	240.5	-18.0	13.3
70 MM MAG (VV)	A0108.2		1	AFT OF RHSSC	1.4	241.0	38.0	53.4
16 MM MAG (II)	A0101.2		1	A1	1.0	273.7	-20.0	-8.5
16 MM MAG (JJ)	A0101.1		1	A1	1.0	273.7	-20.0	-8.5
PENETROMETER DRUM	G4049.1		1	A1	2.0	273.7	-20.0	-8.5
SCB 7 AND SAMPLES	G4056.		1	LOWER BAY LHSSC	16.7	228.0	-40.2	43.2
SCB 8 + CORE TUBES + SAMPLES	G4048.		1	AFT ENG CAN(A14A)	16.6	239.6	-5.5	-14.8
BLSS/ROCK BAG	03060.		1	ON PLUS 227 BULKHEAD	29.5	221.8	-1.0	29.5
SOLAR WIND EXP + BAG	G4011.		1	ISA (A3)	.4	280.0	.0	-10.0
JETTISON BAG + CONTENTS	B1027		1	ISA (A3)	10.0	280.0	.0	-10.0
EVA 3 UNLOAD					87.90	239.61	-9.48	16.66

3.1-120.20

SMA-8-D-027(III) REV 3

TABLE 3.1-9.2 (CONTINUED)

LM EMERGENCY LIFTOFF								
ITEMS REARRANGED IN ASCENT STAGE PRE DEPRESSURIZATION								
DESCRIPTION	STOW. ITEM	REF	NO.	STOWAGE LOCATION	WEIGHT	LM COORDINATES		
						X-C.G.	Y-C.G.	Z-C.G.
JETTISON BAG	B1027.		1	AIG	.9	257.5	-20.0	-18.0
GLOVES, EV			1	CDR HELMET BAG(F10)	2.9	221.0	-18.0	51.0
GLOVES, EV			1	FB	2.9	221.0	18.0	51.0
ARM RESTS	TBD		1	CREW STATION	1.1	251.4	-10.3	56.8
ISS	TBD		1	A1H	1.0	265.9	-20.0	-18.0
OXYGEN PURGE SYSTEM	B1059.		1	A1F	35.9	257.4	-20.7	-6.0
OXYGEN PURGE SYSTEM	B1012.			FIG	35.9	228.0	-40.2	43.2
USED TOWELS	B1043.		2	FIG	.2	228.0	-40.2	43.2
LUNAR BOOTS	B1018.		1	A1K	4.5	273.7	-20.0	-8.5
LUNAR BOOTS	B1018.		1	A1L	4.5	281.0	-20.0	-8.5
LEVA	B1014.		1	CDR HELMET BAG(F10)	5.6	221.0	-18.0	51.0
LEVA	B1014.		1	FB	5.6	221.0	18.0	51.0
HELMET STORAGE BAG	B1058.		1	CDR HELMET BAG(F10)	1.4	221.0	-18.0	51.0
HELMET STORAGE BAG	B1058.		1	FB	1.4	221.0	18.0	51.0
HELMET BAG	TBD		1	FB	1.5	221.0	18.0	51.0
RCU	B1001.		2	A12	10.2	272.0	.0	-18.0
PLSS	B1025.		1	FLOOR	100.5	219.9	-1.3	44.5
TOOL CARRIER	B1063.		1	ON PLUS Z27 BULKHEAD	1.5	221.8	-1.0	29.5
SLEEP RESTRAINT ASSY STRAP	03082.		2	ON FLOOR - PLSS	.2	226.5	-1.5	50.5
USED EMESIS BAG	03011.		3	F1F	.6	235.5	-37.6	46.6
TOOL CARRIER	B1064.		1	ON PLUS Z27 BULKHEAD	1.5	221.8	-1.0	29.5
TETHER	A1029.		1	PLSS AND ISA	.2	268.8	-4.6	44.4
TETHER	A1044.		1	PLSS AND ISA	.7	268.8	-4.6	44.4
UTILITY TOWEL ASSY.	B1008.		2	F1D	.6	242.8	-35.4	47.2
DEFECATION COLLECTION DEVICE	B1009.		3	F1F	.6	235.5	-37.6	46.6
DISPENSER, TISSUE	B1033.		1	F1E	1.4	237.9	-33.6	55.0
FOOD ASSY	C1002.		1	MINUS Z27 BULKHEAD	2.9	288.0	.0	-24.0
WIPES, WET, FACIAL	C1005.		5	F1A	NEGL	244.5	-36.6	31.4
TIE DOWN WEBBING	03069.		1	F7J	.4	271.5	35.4	41.8
70MM MAGAZINE (MM)	A0108.1		1	AFT OF RHSSC	1.4	241.0	38.0	53.4
PURSE AND CONTENTS	TBD		1	ISA (AID)	.9	270.3	-15.0	19.0
EMU MAINTENANCE KIT	B1016.		1	FB	.5	221.0	18.0	51.0

3.1-120.21

SNA-8-D-027(III) REV 3

TABLE 3.1-9.2 (CONTINUED)

Amendment 111
7/22/71

LM EMERGENCY LIFTOFF								
ITEMS REARRANGED IN ASCENT STAGE PRE DEPRESSURIZATION						LM COORDINATES		
DESCRIPTION	STOW. ITEM	REF	NO.	STOWAGE LOCATION	WEIGHT	X-C.G.	Y-C.G.	Z-C.G.
LUNAR SURFACE MAPS	A1008.3		1	ISA (A3)	.5	280.0	.0	-10.0
70MM MAGAZINE (PP)	A0108.1		1	F7C	1.4	242.8	38.0	41.0
70MM MAGAZINE (Q4)	A0108.1		1	F7C	1.4	242.8	38.0	41.0
70MM MAGAZINE (RR)	A0108.1		1	F7C	1.4	242.8	38.0	41.0
70 MM MAG (SS)	A0108.2		1	F7C	1.4	242.8	38.0	41.0
70 MM MAG (TT)	A0108.2		1	F7C	1.4	242.8	38.0	41.0
70 MM MAG (UU)	A0108.2		1	F7C	1.4	242.8	38.0	41.0
70 MM MAG (VV)	A0108.2		1	ISA (A3)	1.4	280.0	.0	-10.0
16 MM MAG (II)	A0101.2		1	ISA (A3)	1.0	280.0	.0	-10.0
16 MM MAG (JJ)	A0101.1		1	ISA (A3)	1.0	280.0	.0	-10.0
PENETRUMETER DRUM	G4049.1		1	ISA (A3)	2.0	280.0	.0	-10.0
PRE DEPR REARRANGE					243.70	240.87	-3.42	24.58

3.1-120.24

SNA-8-D-027(III) REV 3

TABLE 3.1-9.2 (CONTINUED)

NASA—MSC

3.1-120.25

SMA-8-D-027(III) REV 3

LM EMERGENCY LIFTOFF								
ITEMS OFFLOADED AT FINAL DEPRESSURIZATION								
DESCRIPTION	STOW. ITEM	REF	NO.	STORAGE LOCATION	WEIGHT	LM COORDINATES		
						X-C.G.	Y-C.G.	Z-C.G.
JETTISON BAG	B1027.		1	A1G	.9	257.5	-20.0	-18.0
ARM RESTS	TBD		1	CREW STATION	1.1	251.4	-10.3	56.8
USED TOWELS	B1043.		2	F1G	.2	228.0	-40.2	43.2
LUNAR BOOTS	B1018.		1	A1K	4.5	273.7	-20.0	-8.5
LUNAR BOOTS	B1018.		1	A1L	4.5	281.0	-20.0	-8.5
HELMET BAG	TBD		1	F1G	1.5	228.0	-40.2	43.2
RCU	B1001.		2	A12	10.2	272.0	.0	-18.0
PLSS	B1024.		1	A1B	88.1	263.5	-20.6	14.9
PLSS	B1025.		1	FLOOR	88.2	219.9	-1.3	44.5
TOOL CARRIER	B1063.		1	ON PLUS Z27 BULKHEAD	1.5	221.8	-1.0	29.5
SLEEP RESTRAINT ASSY STRAP	03082.		2	ON FLOOR - PLSS	.2	226.5	-1.5	50.5
USED EMESIS BAG	03011.		3	F1F	.6	235.5	-37.6	46.6
TOOL CARRIER	B1064.		1	ON PLUS Z27 BULKHEAD	1.5	221.8	-1.0	29.5
TETHER	A1029.		1	PLSS AND 1SA	.2	268.8	-4.6	44.4
TETHER	A1044.		1	PLSS AND 1SA	.7	268.8	-4.6	44.4
UTILITY TOWEL ASSY.	B1008.		2	F1D	.6	242.8	-35.4	47.2
DEFECATION COLLECTION DEVICE	B1009.		3	F1F	.6	235.5	-37.6	46.6
DISPENSER, TISSUE	B1033.		1	F1E	1.4	237.9	-33.6	55.0
FOOD ASSY	C1002.		1	MINUS Z27 BULKHEAD	2.9	288.0	.0	-24.0
WIPES, WET, FACIAL	C1005.		5	F1A	NEGL	244.5	-36.6	31.4
TIE DOWN WEBBING	03069.		1	F7J	.4	231.5	35.4	41.8
FINAL OFFLOAD					209.80	245.08	-11.03	25.47

U U

TABLE 3.1-10
CONSUMABLES LOADING REQUIREMENTS AND TOLERANCES

Amendment 112
 7/24/71

MISSION J-1
SPS PROPELLANT

Pressure (PSIA)		Temperature (°F)		Quantity Required (%)	
Fuel	Oxidizer	Fuel	Oxidizer	Fuel	Oxidizer
110±4	110±4	70±5	70±5	See Figure 4.1-3	See Figure 4.1-4

SPS Propellant Load (lb)	Loading Requirement		Actual	
	Fuel	Oxidizer	Fuel	Oxidizer
¹ Load	15704.0	25092.0	15664.0	25035.6
² Trapped Outside Tanks	78.6	123.7	78.6	123.7
Tanked	15625.4	24968.3	15585.4	24911.9
² Trapped Inside Tanks	67.6	171.5	67.6	171.5
³ Nominal Deliverable	15557.8	24796.8	15517.8	24740.4

⁴Service Module RCS Propellant

Secondary Fuel - Quads A, B, C, D - See Loading Window - Figure 4.3-1.

Primary Fuel - Quads A, B, C, D - See Loading Window - Figure 4.3-2.

Primary and Secondary Oxidizer - Quads A, B, C, D - See Loading Window - Figure 4.3-3.

⁵Command Module RCS Propellant

Fuel - System A and B - See Loading Window - Figure 4.3-4.

Oxidizer - System A and B - See Loading Window - Figure 4.3-5.

⁹Helium and Nitrogen

Consumable	Loading Requirement				Actual	
	Pressure	Temp	Weight	Earth Launch	Pressure	Temp
	(PSIA)	(°F)	(lb)	Weight (lb)	(PSIA)	(°F)
Helium - SPS Bottles	3600	70	87.6	87.6	3590	87
Helium - Fuel Tanks	178	70	5.4		181	74
Helium - N ₂ O ₄ Tanks	178	70			181	72
Helium - SM/RCS						
Quads A	4150	70	6.0	6.0	4190	71
Quads B	4150	70			4200	72
Quads C	4150	70			4190	71
Quads D	4150	70			4220	72
Helium - CM/RCS						
System A	4150	70	1.0	1.0	4160	69
System B	4150	70			4110	65
Nitrogen - SM						
Primary	2500	85	1.3	1.3	2550	70
Secondary	2500	85			2550	70



TABLE 3.1-10 (CONTINUED)

Command Module Water and GOX

	Pressure (PSIA)	Loading Requirement Weight (lb)	Earth Launch Weight (lb)	Actual
Waste Water ⁶			35.0	39.0
Potable Water ⁷			30.0	26.1
CM/GOX	900±50	3.7	6.7 (Entry)	

⁸Service Module Hydrogen and Oxygen

	Loading Req. Per Tank (pounds)	Earth Launch Weight Per Tank (lb)	Actual per Tank (lb)
Hydrogen			
Tank 1	29.3	27.6	27.3
Tank 2	29.3	27.6	27.6
Tank 3	29.3	27.6	27.3
Oxygen			
Tank 1	330.1	316.6	313.9
Tank 2	330.1	316.6	313.9
Tank 3	330.1	316.6	313.9

NOTES:

- ¹Indicated propellant load is based on nominal pressure and temperature prior to actual loading. This number will be updated after loading is accomplished.
- ²See Section 4.1 for explanation of trapped SPS propellant.
- ³See Table 3.1-13 for loading uncertainties.
- ⁴See Section 4.2 for SM/RCS loads and uncertainties to be used in Mission Planning. Actual SM/RCS loads and uncertainties will be published in Table 3.1-15.
- ⁵See Section 4.2 for CM/RCS loads and uncertainties to be used in Mission Planning. Actual CM/RCS loads and uncertainties will be published in Table 3.1-14.
- ⁶Launch Rule Redlines determine lift-off values.
- ⁷Launch Rule Redlines determine lift-off values.
- ⁸Launch Mission Rules will determine minimum lift-off quantities for H₂ and O₂.
- ⁹CSM helium and nitrogen should be loaded in accordance with loading windows contained in CSM/LM Spacecraft Operational Data Book, Volume I, Part 2, SNA-8-D-027(1) P2.

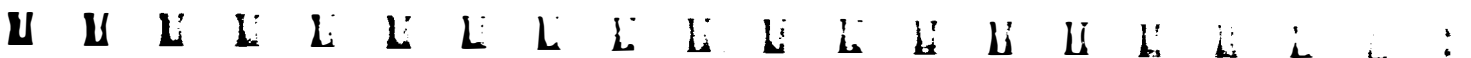

TABLE 3.1-11

Amendment 110
7/19/71

SPS PROPELLANT LOAD CALCULATION

	<u>FUEL</u>	<u>OXIDIZER</u>
1. Enter SPS Quantity Readout at 110 PSIA (Table 3.1-12 item C - Percent)	<u>100.8</u>	<u>100.7</u>
2. Use Figures 4.1-3 and 4.1-4 to obtain propellant load for above quantity readout.	15,688.0	25,042.0
3. Nominal propellant density at loading temperature (use temperature - density graph below) (lb/ft ³)	<u>56.46</u>	<u>89.97</u>
4. Cubic feet of propellant (item 2 divided by item 3)	<u>277.86</u>	<u>278.33</u>
5. Calculated density from Table 3.1-12 item f (lb/ft ³)	<u>56.37</u>	<u>89.94</u>
6. Adjustment due to PUGS zero adjust (pounds)	-	-
7. Resulting actual propellant load (item 4 times item 5, less item 6) (pounds)	<u>15,664.0</u>	<u>25,035.6</u>

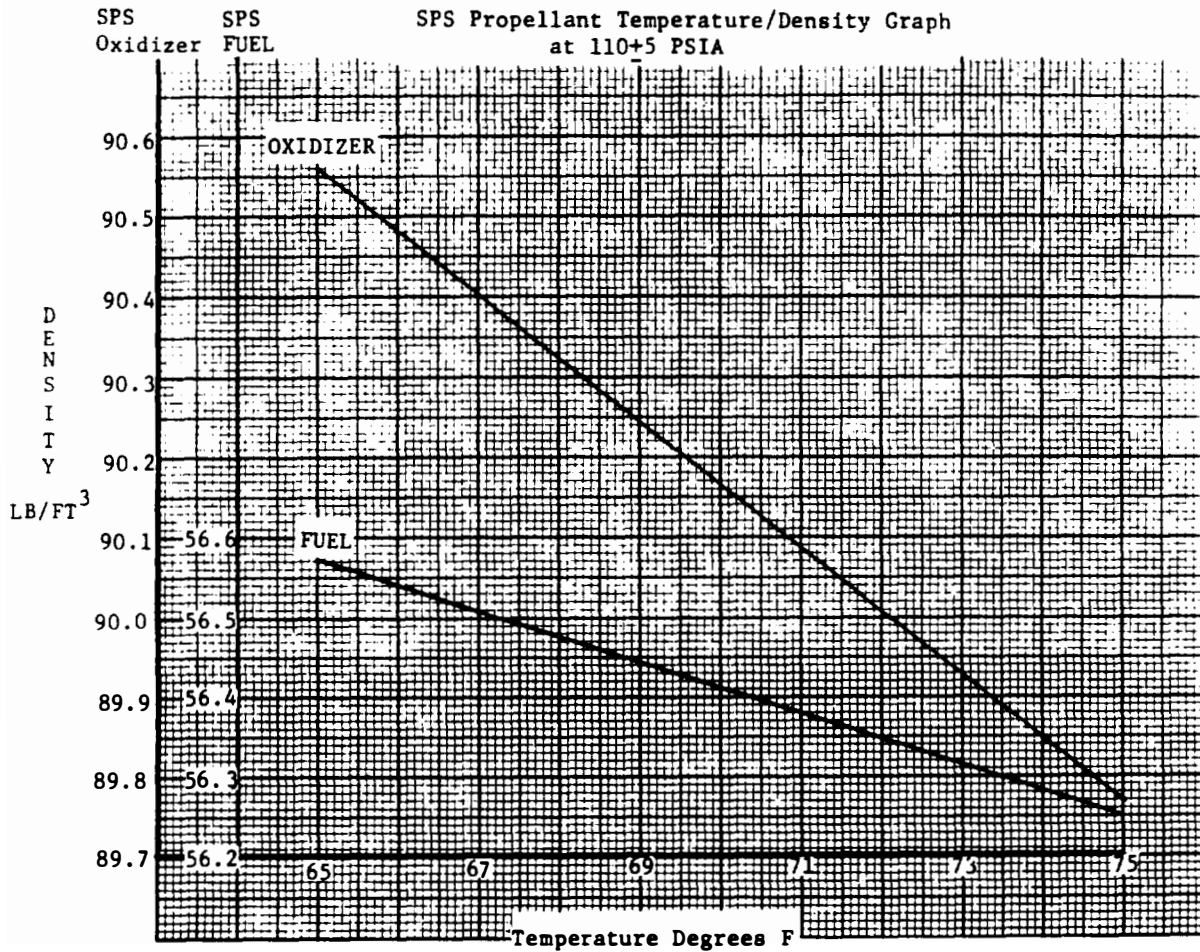

TABLE 3.1-12

MISSION J-1 SPS PROPELLANT LOAD PARAMETERS
(To be provided by KSC following loading)

Enter the following information at zero adjust - time			
<u>Fuel</u>		<u>Oxidizer</u>	
Adjusted quantity fuel readout - Percent	<u>0.0</u>	Adjusted quantity oxidizer readout - Percent	<u>0.0</u>
Fuel storage voltage reading taken from ACE to three significant digits - volts	<u>0.0</u>	Oxidizer storage voltage reading taken from ACE to three significant digits - volts	<u>0.0</u>
Fuel sump voltage reading taken from ACE to three significant digits - volts	<u>0.0</u>	Oxidizer sump voltage reading taken from ACE to three significant digits - volts	<u>0.0</u>

Enter the following information at Sump Tank Full Adjust (Propellant at top of standpipe)			
<u>Fuel</u>		<u>Oxidizer</u>	
Fuel sump tank pressure - PSIA	<u>29.1</u>	Oxidizer sump tank pressure - PSIA	<u>30.0</u>
Fuel temperature - °F	<u>69.1</u>	Oxidizer temperature - °F	<u>72.1</u>
Adjusted quantity fuel readout - Percent	<u>55.1</u>	Adjusted quantity oxidizer readout - %	<u>55.0</u>
Fuel sump voltage reading taken from ACE to three significant digits - volts	<u>4.70</u>	Oxidizer sump voltage reading taken from ACE to three significant digits - volts	<u>4.58</u>

Enter the following information at Storage Tank Full Adjust (Propellant at Point Sensor #1)			
<u>Fuel</u>		<u>Oxidizer</u>	
Fuel storage tank pressure - PSIA	<u>112.0</u>	Oxidizer storage tank pressure - PSIA	<u>112.0</u>
Fuel temperature - °F	<u>68.6</u>	Oxidizer temperature - °F	<u>72.5</u>
Adjusted quantity fuel readout - %	<u>95.9</u>	Adjusted quantity oxidizer readout - %	<u>95.8</u>
Fuel storage voltage reading taken from ACE to three significant digits - volts	<u>4.05</u>	Oxidizer storage voltage reading taken from ACE to three significant digits - volts	<u>4.03</u>
Fuel sump voltage reading taken from ACE to three significant digits - volts	<u>4.61</u>	Oxidizer sump voltage reading taken from ACE to three significant digits - volts	<u>4.62</u>

3.1-124

SNA-8-D-027 (III) REV 3

U
 N
 I
 T
 E
 D
 S
 T
 A
 T
 E
 S
 O
 F
 A
 E
 R
 O
 N
 A
 N
 D
 S
 P
 A
 C
 E

TABLE 3.1-12 (CONTINUED)

Amendment 110
7/19/71

Enter the following information when tanking is complete (110±5 PSIA) Time			
<u>Fuel</u>		<u>Oxidizer</u>	
a. System pressure - PSIA	<u>110.0</u>	a. System pressure - PSIA	<u>112.0</u>
b. Fuel temperature - °F	<u>68.6</u>	b. Oxidizer temperature - °F	<u>72.5</u>
c. Quantity fuel readout - %	<u>100.8</u>	c. Quantity oxidizer readout - %	<u>100.7</u>
d. Fuel measured specific gravity @ 25°C - 14.7 PSIA	<u>0.8979</u>	d. Oxidizer measured specific gravity @ 4°C - 14.7 PSIA	<u>1.4819</u>
e. Fuel measured density 25°C - 14.7 PSIA (Item d times 62.428) - lb/ft ³	<u>56.054</u>	e. Oxidizer measured density @ 4°C - 14.7 PSIA (Item d times 62.428) - lb/ft ³	<u>92.512</u>
f. Calculated density - lb/ft ³ - at system pressure and temperature Items a and b above. Use density equation outlined in Section 4.1.	<u>56.326</u>	f. Calculated density - lb/ft ³ - at system pressure and temperature, Item a and b above. Use density equation outlined in Section 4.1.	<u>89.94</u>
g. Fuel storage voltage reading from ACE	<u>4.55</u>	g. Oxidizer storage voltage reading from ACE	<u>4.53</u>
h. Fuel sump voltage reading from ACE	<u>4.62</u>	h. Oxidizer sump voltage reading from ACE	<u>4.65</u>

3.1-125

Enter the following information at leak check pressure			
<u>Fuel</u>		<u>Oxidizer</u>	
System pressure - PSIA	<u>189.0</u>	System pressure - PSIA	<u>189.0</u>
Quantity fuel readout - %	<u>100.48</u>	Quantity oxidizer readout - %	<u>100.32</u>
Fuel storage voltage reading from ACE	<u>4.41</u>	Oxidizer storage voltage readout from ACE	<u>4.37</u>
Fuel sump voltage reading from ACE	<u>4.70</u>	Oxidizer sump voltage readout from ACE	<u>4.74</u>

SNA-8-D-027 (III) REV 3

SPS PROPELLANT UNCERTAINTIES

ITEM	FUEL	OXIDIZER
	(lb)	(lb)
<u>LOADING UNCERTAINTIES</u>		
Tank Volume	±24	±39
Temperature Gauge (±2.0°F)	±18	±46
Standpipe Height	± 6	±10
Propellant Gauge (±0.35% of Gaugeable)	±54	±86
Density Measurement (1)	± 5	± 5
Batch Density (1)	± 0	± 0
Loading Pressure (1)	± 8	±14
RSS	± 63	±106
TOTAL RSS	±123	
Loading Specification (1) (2)	± 0	± 0
Tolerance on Propellant Temperature of Flight Load	+ 0 - 0	+ 0 - 0
TOTAL LOADING UNCERTAINTY	±123	

- NOTES: (1) Data will be known after loading is accomplished.
- (2) Loading specification is an allowable tolerance about nominal, this number is added to the loading uncertainty variable.

U U E E E E L L E E E E U U E E L L E

TABLE 3.1-14

COMMAND MODULE RCS LOADING PARAMETERS AND CALCULATIONS

This table will be completed when loading is accomplished. For Mission Planning, reference should be made to Section 4.2 for nominal load, loading tolerances, trapped and deliverable propellants.

	<u>FUEL</u>		<u>OXIDIZER</u>	
	<u>Tank A</u>	<u>Tank B</u>	<u>Tank A</u>	<u>Tank B</u>
A. Tank Volume @0.0 PSIA (in ³)	<u>1474.7</u>	<u>1471.7</u>	<u>1786.9</u>	<u>1791.0</u>
B. Liquid Line Volume (in ³)	<u>21.0</u>	<u>17.4</u>	<u>17.1</u>	<u>16.4</u>
C. Total A + B (in ³)	<u>1495.7</u>	<u>1489.1</u>	<u>1804.0</u>	<u>1807.4</u>
D. Initial Weight in Bleed Unit Prior to Loading (lb)	<u>149.0</u>	<u>103.8</u>	<u>195.0</u>	<u>115.2</u>
E. Final Weight in Bleed Unit After Loading (lb)	<u>104.8</u>	<u>59.6</u>	<u>116.7</u>	<u>36.9</u>
F. Propellant Load (item D less than E Weigh Tank)	<u>44.2</u>	<u>44.2</u>	<u>78.3</u>	<u>78.3</u>
G. Propellant Load by P.V.	<u>44.2</u>	<u>44.3</u>	<u>77.6</u>	<u>78.4</u>
H. Loading Temperature (°F)	<u>72</u>	<u>72</u>	<u>69</u>	<u>69</u>
I. Specification Propellant Load @ 70±5°F (lb)	<u>88.4</u>		<u>156.6</u>	
J. Total CM/RCS Propellant Load from Item G above (lb)	<u>88.5</u>		<u>156.0</u>	
K. Maximum Trapped Propellant (lb)	<u>13.3</u>		<u>23.1</u>	
L. Nominal Deliverable (lb)	<u>75.2</u>		<u>132.9</u>	



TABLE 3.1-15

SERVICE MODULE RCS LOADING SUMMATION

This table will be completed when loading is accomplished. For Mission Planning, reference should be made to Section 4.2, for nominal load, loading tolerances, and nominal deliverable propellants.

<u>Quad A (1b)</u>		<u>Quad B (1b)</u>	
Secondary Fuel	<u>40.3</u>	Secondary Fuel	<u>40.3</u>
Primary Fuel	<u>69.0</u>	Primary Fuel	<u>69.0</u>
Total Fuel	<u>109.3</u> ±0.7	Total Fuel	<u>109.3</u> ±0.7
Maximum Trapped	<u>2.1</u>	Maximum Trapped	<u>2.1</u>
Nominal Deliverable	<u>107.2</u>	Nominal Deliverable	<u>107.2</u>
Total Oxidizer	<u>225.8</u> ±2.3	Total Oxidizer	<u>224.0</u> ±2.3
Maximum Trapped	<u>4.5</u>	Maximum Trapped	<u>4.5</u>
Nominal Deliverable	<u>221.3</u>	Nominal Deliverable	<u>219.5</u>
<u>Quad C (1b)</u>		<u>Quad D (1b)</u>	
Secondary Fuel	<u>40.3</u>	Secondary Fuel	<u>40.3</u>
Primary Fuel	<u>69.4</u>	Primary Fuel	<u>69.2</u>
Total Fuel	<u>109.7</u> ±0.7	Total Fuel	<u>109.5</u> ±0.7
Maximum Trapped	<u>2.1</u>	Maximum Trapped	<u>2.1</u>
Nominal Deliverable	<u>107.6</u>	Nominal Deliverable	<u>107.4</u>
Total Oxidizer	<u>224.6</u> ±2.3	Total Oxidizer	<u>224.1</u> ±2.3
Maximum Trapped	<u>4.5</u>	Maximum Trapped	<u>4.5</u>
Nominal Deliverable	<u>220.1</u>	Nominal Deliverable	<u>219.6</u>
<u>Total SM/RCS Propellant Load (1b)</u>			
Total Fuel	<u>437.8</u> ±1.4	Total Oxidizer	<u>898.5</u> ±4.6
Maximum Trapped	<u>8.4</u>	Maximum Trapped	<u>18.0</u>
Nominal Deliverable	<u>429.4</u>	Nominal Deliverable	<u>880.5</u>

M U L T I P L E L E T T E R S

TABLE 3.1-16

LM-10 CONSUMABLE LOADING REQUIREMENTS

LM-10 APS PROPELLANT

	<u>Fuel (lb)</u>	<u>Oxidizer (lb)</u>
Propellant Load	<u>2011.4</u>	<u>3225.6</u>
Trapped Outside Tanks	<u>5.9</u>	<u>8.3</u>
Tanked	<u>2005.5</u>	<u>3217.3</u>
Trapped Inside Tanks	<u>10.0</u>	<u>27.7</u>
Nominal Deliverable	<u>1995.5</u>	<u>3189.6</u>
Outage	<u>TBD</u>	<u>TBD</u>
Total APS Propellant	<u>TBD</u>	<u>TBD</u>

The following table should be used to determine the amount of propellant to be off-loaded from a full condition to arrive at the indicated load. The allowable tolerance for the calculated off-load is ±0.5 pounds per weigh tank.

A. Final tank pressure at overfill (PSIG)	<u>60.3</u>	<u>50.3</u>
B. Propellant loading temperature (°F)	<u>69.0</u>	<u>70.25</u>
C. Nominal overfill quantity (lb)	<u>2069.8</u>	<u>3315.6</u>
D. Correction for tank pressure (lb)	<u>1.83</u>	<u>1.55</u>
Fuel = 0.09 (Item A-40)		
Oxidizer = 0.15 (Item A-40)		
¹ E. Correction for loading temperature (lb)		
Fuel = 1.16 (Item B-65)		
Oxidizer = -2.84 (Item B-65)	<u>-4.64</u>	<u>-14.91</u>
² F. Measured density (GM/CC)	<u>0.8979</u>	<u>1.4819</u>
² G. Nominal density (GM/CC)	<u>0.8994</u>	<u>1.4824</u>
H. Delta density (GM/CC) (Item F-G)	<u>-0.0015</u>	<u>-0.0005</u>
³ I. Correction for measured density		
Fuel = 2300 (Item H)	<u>-3.45</u>	<u>-1.15</u>
Oxidizer = 2300 (Item H)		
J. Propellant in GSE	<u>1.6</u>	<u>4.8</u>
K. Overfill quantity (C+D+E+I+J)	<u>2065.1</u>	<u>3305.9</u>
L. Target loading	<u>2014.2</u>	<u>3225.7</u>
M. Quantity required to fill RCS manifolds	<u>10.0</u>	<u>15.8</u>
N. Quantity to be off-loaded (Item K-L-M)	<u>40.9</u>	<u>64.5</u>

NOTES:

¹Loading temperature correction will always be negative.

²To calculate the nominal density solve the following equation where T = temperature in °C of the measured density (usually 4°C for oxidizer and 25°C for fuel). This equation is valid for 14.7 PSIA. Therefore, the measured density must also be at 14.7 PSIA.

Nominal fuel density = 0.922904-0.0009377 (°C)

Nominal oxidizer density = 1.491539-0.0022832 (°C)

³Correction for measured density may be either positive or negative.

TABLE 3.1-16 (CONTINUED)
LM-10 CONSUMABLE LOADING REQUIREMENTS
LM-10 DPS PROPELLANT

	<u>Fuel (lb)</u>	<u>Oxidizer (lb)</u>
Propellant Load	7537.6	12023.9
Trapped Outside Tanks	27.3	48.9
Tanked	7510.3	11975.0
Trapped Inside Tanks	10.5	23.5
Nominal Deliverable	7499.8	11951.5
Outage	TBD	TBD
Total DPS Propellant	TBD	

The following table should be used to determine the amount of propellant to be off-loaded from a full condition to arrive at the indicated load. The allowable tolerance for the calculated off-load is ± 0.5 pounds per weigh tank.

A1. Final tank pressure at overfill (PSIG)	47.4	54.0
B1. Propellant loading temperature ($^{\circ}$ F)	67.8	67.45
C1. Nominal overfill quantity (lb)	7606.6	12182.5
D1. Correction for tank pressure (lb)	2.44	7.56
Fuel = 0.33 (Item A1 -40) Oxidizer = 0.54 (Item A1 -40)		
¹ E1. Correction for loading temperature (lb)	-11.9	-25.73
Fuel = -4.25 (Item B1 -65) Oxidizer = -10.5 (Item B1 -65)		
² F1. Measured density (GM/CC)	0.8979	1.4819
² G1. Nominal density (GM/CC)	0.8994	1.4824
H1. Delta density (GM/CC) (Item F1-Item G1)	-0.0015	-0.0005
³ I1. Correction for measured density	-12.6	-4.2
Fuel = 8400 (Item H1) Oxidizer = 8400 (Item H1)		
J1. Propellant in GSE	2.3	3.8
K1. Overfill quantity (C1+D1+E1+I1+J1)	7586.8	12163.9
L1. Target loading	7547.7	12023.7
M1. Quantity required to fill RCS manifolds (APS only)	xxxxxxx	xxxxxxx
N1. Quantity to be off-loaded (Items K1-L1-M1)	39.1	140.2

NOTES:

¹Loading temperature correction will always be negative.

²To calculate the nominal density solve the following equation where T = temperature in $^{\circ}$ C of the measured density (usually 4° C for oxidizer and 25° C for fuel). This equation is valid for 14.7 PSIA. Therefore, the measured density must also be at 14.7 PSIA.

Nominal fuel density = $0.922904 - 0.0009377 (^{\circ}$ C)

Nominal oxidizer density = $1.491539 - 0.0022832 (^{\circ}$ C)

³Correction for measured density may be either positive or negative.



TABLE 3.1-16 (CONTINUED)
LM-10 - RCS PROPELLANT (2) (3)

	Required	Ullage Requirement (in ³)		¹ Actual ⁵	¹ Actual ⁴
	Load (lb) ⁵	Minimum ⁴	Maximum ⁴	Load (lb)	Ullage (in ³)
System A Fuel	107.4±0.9	152.5	164.5	107.4	172.0
System A Oxidizer	208.2±1.9	267.0	279.0	208.2	267.0
System B Fuel	107.4±0.9	152.5	164.5	107.4	151.0
System B Oxidizer	208.2±1.9	267.0	279.0	208.2	255.8

	FUEL	OXIDIZER
Propellant Load	214.8	416.4
Trapped Outside Tanks	10.0	15.8
Tanked	204.8	400.6
Trapped in Tanks	4.2	8.0
Nominal Deliverable	200.6	392.6

LM-10 - Helium & Nitrogen

Consumable	Nominal Loading Requirement			Actual		
	Pressure (PSIA)	Temp (°F)	Weight (lb)	Pressure (PSIA)	Temp (°F)	Weight (lb)
Helium - APS tank #1 (6)	3050	70	6.6	3142	68.9	
- APS tank #2 (6)	3050	70	6.6	3137	69.1	
- RCS tank #1 (6)	3050	70	1.05	3057	69.7	
- RCS tank #2 (6)	3050	70	1.05	3043	69.7	
- DPS (SHe)	80±2	N/A	51.2			
- DPS (Ambient) (6)	1600	70	1.1	1625	70.6	
Nitrogen - Ascent			0.1			
- Descent			0.6			
- Descent			-0.6			

LM-10 - Water & GOX

Consumable	Nominal Loading Requirement		Actual	
	Pressure (PSIA)	Weight (lb)	Pressure (PSIA)	Weight (lb)
Ascent Water - tank #1	N/A	(7)	N/A	42.5
- tank #2	N/A	(7)	N/A	42.5
Descent Water - tank #1	N/A	(7)	N/A	207.0
- tank #2	N/A	(7)	N/A	207.0
Ascent GOX - tank #1 (6)	830	2.4	845	(71°F)
- tank #2 (6)	830	2.4	850	(71°F)
Descent GOX - tank #1 (6)	2700	46.9	2620	(72.1°F)
- tank #2 (6)	2700	46.9	2620	(72.1°F)

NOTES:

- ¹See Table 3.1-17 for actual propellant load calculation.
- ²See Section 5.6 for explanation of trapped propellants.
- ³See Table 3.1-18 for loading uncertainties.
- ⁴PV ullage calculation should be 166.5±50 cubic inches for LM/RCS fuel and 280±50 cubic inches for LM/RCS oxidizer per tank.
- ⁵LM/RCS required load includes propellant required to fill RCS manifolds to thruster valves. See Table 3.1-16. See Section 5.6 for trapped propellants.
- ⁶The indicated items should be loaded in accordance with loading windows contained in the CSM/LM Spacecraft Operational Data Book, Volume II, Part 2, SNA-8-D-027PT2.
- ⁷LM-10 Descent Water shall be loaded to provide 408-0.0+10.0 pounds at Earth Launch. LM-10 ascent water shall be loaded to provide 85 pounds at earth launch. Initial load will be determined by the pressure-temperature relationships provided in Table 3.1-16.1.



TABLE 3.1-16.1 ECS WATER LOADING DATA LM-10

T	Po	DESCENT TANKS			ASCENT TANKS	
	°F	PSIA	PSIA	PSIA	PSIA	PSIA
60	11,607	22,212	39,245	39,501	46,427	46,683
61	11,629	22,254	39,321	39,587	46,516	46,782
62	11,651	22,306	39,396	39,671	46,605	46,880
63	11,674	22,340	39,472	39,757	46,695	46,980
64	11,695	22,383	39,547	39,842	46,784	47,079
65	11,718	22,425	39,623	39,929	46,873	47,179
66	11,741	22,469	39,698	40,014	46,963	47,279
67	11,763	22,511	39,774	40,102	47,052	47,380
68	11,785	22,553	39,849	40,188	47,141	47,480
69	11,808	22,597	39,924	40,275	47,231	47,582
70	11,830	22,639	40,000	40,363	47,320	47,683
71	11,852	22,681	40,075	40,451	47,409	47,785
72	11,875	22,725	40,151	40,540	47,499	47,888
73	11,897	22,767	40,226	40,628	47,588	47,990
74	11,919	22,809	40,302	40,718	47,677	48,093
75	11,942	22,853	40,377	40,807	47,767	48,197
76	11,964	22,895	40,453	40,897	47,855	48,299
77	11,986	22,937	40,528	40,987	47,945	48,404
78	12,009	22,982	40,604	41,079	48,035	48,510
79	12,031	23,024	40,679	41,170	48,124	48,615
80	12,053	23,066	40,755	41,262	48,213	48,720

- NOTE: 1. Po - Initial Gas Pressure Setting
 Pf1 - Pressure Required when Loading "Killer" Solution.
 PFN - Pressure Required for D/S N₂ Final Fill.
 PF2 - Pressure Required After Partial Drain and Refill.
2. Primary Reading of Pf1 using 0-60 psia Transducers verified by GF 4501 P.
 * Pf1 = GF 4501 P + HEAD if GF 4501 P low, increase to required pressure.
 D/S Tank #1 HEAD = 2.502 PSI
 D/S Tank #2 HEAD = 3.372 PSI
3. Po, Pf1*, PFN, PF2, Pf1 values as shown above, may have a tolerance of (+) one (1) PCM Bit as read on CRT.

MID	1 Bit
GF 4501 P	.1 psia
GF 4500 P	.24 psia
GF 0500 P	.24 psia
GF 4502 P	.24 psia
GF 4503 P	.24 psia

4. This table provides nominal descent loading of 212 lb/tank and ascent tank loading of 42.5 lb/tank.



TABLE 3.1-17

LOAD CALCULATION

<u>APS PROPELLANT</u>		<u>Fuel</u>	<u>Oxidizer</u>		
1.	Full tank - Item K, Table 3.1-16 (lb)	<u>2065.1</u>	<u>3305.9</u>		
¹ 2.	Density of off-load tables at loading temperature and pressure (lb/ft ³)	<u>N/A</u>	<u>N/A</u>		
¹ 3.	Propellant volume (divide item 1 by item 2. (ft ³))	<u>N/A</u>	<u>N/A</u>		
¹ 4.	Measured density (from Table 3.1-19) (lb/ft ³)	<u>N/A</u>	<u>N/A</u>		
5.	Resulting full tank load (lb)	<u>2065.1</u>	<u>3305.9</u>		
* 6.	Off-load amount (lb)	<u>43.7</u>	<u>64.5</u>		
7.	Propellant required to fill RCS manifolds (lb)	<u>10.0</u>	<u>15.8</u>		
8.	Propellant load (lb)	<u>2011.4</u>	<u>3225.6</u>		
<u>DPS PROPELLANT</u>		<u>Fuel</u>	<u>Oxidizer</u>		
9.	Full tank - Item K1 Table 3.1-16	<u>7586.8</u>	<u>12163.9</u>		
¹ 10.	Density of off-load tables at loading temperature and pressure (lb/ft ³)	<u>N/A</u>	<u>N/A</u>		
¹ 11.	Propellant volume (divide Item 9 by Item 10)(ft ³)	<u>N/A</u>	<u>N/A</u>		
¹ 12.	Measured density (from Table 3.1-19) (lb/ft ³)	<u>N/A</u>	<u>N/A</u>		
13.	Resulting full tank load (lb)	<u>7586.8</u>	<u>12163.9</u>		
14.	Off-load amount (lb)	<u>49.2</u>	<u>140.0</u>		
15.	Propellant load (lb)	<u>7537.6</u>	<u>12023.9</u>		
<u>RCS PROPELLANT</u>		<u>Fuel</u>		<u>Oxidizer</u>	
P. V. Calculations		<u>Tank A</u>	<u>Tank B</u>	<u>Tank A</u>	<u>Tank B</u>
A.	GSE Volume (in ³)	<u>18.2</u>	<u>33.5</u>	<u>17.8</u>	<u>29.7</u>
B.	Initial Ullage Pressure (PSIG)	<u>33.4</u>	<u>33.5</u>	<u>35.2</u>	<u>34.8</u>
C.	Initial GSE Pressure (PSIG)	<u>1.0</u>	<u>1.0</u>	<u>0.0</u>	<u>0.2</u>
D.	Final GSE - S/C Pressure (PSIG)	<u>30.3</u>	<u>27.6</u>	<u>33.0</u>	<u>31.2</u>
E.	Ullage Volume (in ³) - Solve the following equation by substituting the values in the indicated steps.	<u>172.0</u>	<u>151.0</u>	<u>267.0</u>	<u>255.8</u>
	Ullage Volume = $\frac{(D-C)(A)}{B-D}$				

NOTE: ¹These items will be completed only if a density sample is not made prior to loading. If a density sample is made prior to loading, then the items will be left blank.

*Initial APS & DPS Fuel Offload was based on a density of 0.8991 instead of 0.8979 gm/CC.

LM-10 PROPELLANT LOADING UNCERTAINTIESLM-10 APS PROPELLANT

	<u>Fuel (lb)</u>	<u>Oxidizer (lb)</u>
Vent Line Volume	<u>±0.2</u>	<u>±0.3</u>
Tank Volume	<u>±0.8</u>	<u>±1.3</u>
Pressure Measurement (±5 PSIA)	<u>±0.5</u>	<u>±0.8</u>
Temperature Measurement (±1.5°F)	<u>±1.7</u>	<u>±4.3</u>
Measured Density	<u>±0.7</u>	<u>±0.5</u>
Weight Measurement	<u>±0.5</u>	<u>±0.5</u>
¹ Loading Tolerance	<u>±0.0</u>	<u>±0.0</u>
Total Loading Uncertainty	<u>±4.3</u>	<u>±7.7</u>

LM-10 DPS PROPELLANT

Vent Line Volume	<u>±0.2</u>	<u>±0.3</u>
Tank Volume	<u>±3.62</u>	<u>±5.96</u>
Pressure Measurement (±5 PSIA)	<u>±1.70</u>	<u>±2.77</u>
Temperature Measurement (1.5°F)	<u>±6.49</u>	<u>±15.76</u>
Measured Density	<u>±2.55</u>	<u>±1.70</u>
Weight Measurement	<u>±0.5</u>	<u>±0.5</u>
¹ Loading Tolerance	<u>±0.0</u>	<u>±0.0</u>
Total Loading Uncertainty	<u>±15.1</u>	<u>±27.0</u>

LM-10 RCS PROPELLANT

Loading Temperature	<u>±0.6</u>	<u>±1.8</u>
Ullage Calculation	<u>±0.4</u>	<u>±0.6</u>
Tank and Manifold Volume	<u>±0.8</u>	<u>±1.4</u>
Total	<u>±1.8</u>	<u>±3.8</u>

¹These will be known quantities after loading is accomplished.

TABLE 3.1-19

LM-10 APS PROPELLANT LOADING PARAMETERS
(To Be Completed by KSC at Loading)

	<u>Fuel</u>	<u>Oxidizer</u>
Loading Pressure - PSIA	<u>75.0</u>	<u>65.0</u>
Loading Temperature - Fill Line - Degrees F		
TT 58 Fuel		
TT258 Oxidizer	<u>67.8</u>	<u>70.3</u>
Loading Temperature - Return Line - Degrees F		
TT 59 Fuel		
TT259 Oxidizer	<u>70.2</u>	<u>70.2</u>
Loading Temperature - Tank - Degrees F		
GP0718 Fuel		
GP1218 Oxidizer	<u>68.2</u>	<u>69.4</u>
Number of Times Weigh Tank Used (Flow Meter Not Used)	<u>1</u>	<u>1</u>
Total Pounds Off-Loaded Using Weigh Tank (Flow Meter Not Used)	<u>43.7</u>	<u>64.5</u>
Pounds Off-Loaded Using Flow Meter (Weigh Tank Not Used)	<u>N/A</u>	<u>N/A</u>
Measured Fuel Density @ 25°C; @ 14.7 PSIA GM/CC	<u>0.8991</u>	<u>-</u>
Measured Oxidizer Density @ 4°C; @ 14.7 PSIA GM/CC	<u>-</u>	<u>1.4819</u>

TABLE 3.1-19 (CONTINUED)

LM-10 DPS PROPELLANT LOADING PARAMETERS

	<u>Fuel</u>	<u>Oxidizer</u>
Loading Pressure - PSIA	<u>62.1</u>	<u>68.7</u>
Loading Temperature - Fill Line - Degrees F		
TT 58 Fuel		
TT258 Oxidizer	<u>67.3</u>	<u>66.6</u>
Loading Temperature - Return Line - Degrees F		
TT 59 Fuel		
TT259 Oxidizer	<u>68.2</u>	<u>68.3</u>
Loading Temperature - Tank One - Degrees F		
GQ3718 Fuel		
GQ4218 Oxidizer	<u>68.2</u>	<u>68.6</u>
Loading Temperature - Tank Two - Degrees F		
GQ3719 Fuel		
GQ4219 Oxidizer	<u>68.6</u>	<u>68.6</u>
Number of Times Weigh Tank Used (Flow Meter Not Used)	<u>1</u>	<u>1</u>
Total Pounds Off-Loaded Using Weigh Tank (Flow Meter Not Used)	<u>49.2</u>	<u>140.0</u>
Pounds Off-Loaded Using Flow Meter (Weigh Tank Not Used)	<u>N/A</u>	<u>N/A</u>
Measured Fuel Density @ 25°C; @ 14.7 PSIA GM/CC	<u>0.8991</u>	
Measured Oxidizer Density @ 4°C; @ 14.7 PSIA GM/CC		<u>1.4819</u>



MISSION J-1 MASS PROPERTY DATA TABLES

- Table 3.1-20 presents the CSM-112/LM-10 (docked) mass properties, in Apollo coordinates, as a function of spacecraft weight for L.O.I. SM/SPS burn.
- Table 3.1-21 presents the CSM-112/LM-10 (docked) mass properties, in Apollo coordinates, as a function of spacecraft weight for the D.O.I. SM/SPS burn.
- Table 3.1-22 presents the CSM-112 mass properties, in Apollo coordinates, as a function of CSM weight for the Circularization I SM/SPS burn.
- Table 3.1-23 presents the CSM-112 mass properties, in Apollo coordinates, as a function of CSM weight for the Plane Change I SM/SPS burn.
- Table 3.1-24 presents the CSM-112 mass properties, in Apollo coordinates, as a function of CSM weight for the T.E.I. SM/SPS burn.
- Table 3.1-25 presents the LM-10 mass properties, in LM coordinates, as a function of LM weight for the P.D.I. DPS burn.
- Table 3.1-26 presents the LM-10 ascent stage mass properties, in LM coordinates, as a function of weight for the lunar liftoff APS burn.
- Table 3.1-27 presents the LM-10 mass properties, in LM coordinates, as a function of LM weight for the T.P.I. to docking LM/APS burn.



X (A) COORDINATES

TABLE 3.1-20

CSM-112/ LM-10 L.O.I. BURN

WEIGHT LBS.	X-BAR	Y-BAR INCHES	Z-BAR	IXX	IYY	IZZ SLUG-FT SQ	PXY	PXZ	PYZ	PITCH DEGREES	YAW	AVERAGE MOMENT	INERTIA/THRUST RATIO
102692.0	1041.30	2.99	3.45	62028	574327	577100	-11117	-5805	2075	1.199	-.127	575714	1.571
101692.0	1042.06	2.98	3.38	61503	572584	575792	-11110	-5678	1930	1.223	-.131	574188	1.561
100692.0	1042.90	2.98	3.30	60579	570543	574185	-11102	-5537	1784	1.248	-.136	572364	1.550
99692.0	1043.84	2.98	3.23	60454	568174	572252	-11093	-5380	1639	1.273	-.141	570213	1.537
98692.0	1044.87	2.97	3.15	59929	565449	569962	-11084	-5207	1494	1.298	-.146	567705	1.523
97692.0	1046.00	2.97	3.07	59404	562336	567285	-11073	-5018	1348	1.324	-.151	564810	1.507
96692.0	1047.23	2.96	2.98	58678	558802	564186	-11062	-4813	1203	1.351	-.157	561494	1.490
95692.0	1048.56	2.96	2.90	58352	554811	560631	-11050	-4590	1058	1.378	-.163	557721	1.470
94692.0	1050.00	2.95	2.82	57826	550325	556582	-11036	-4349	912	1.406	-.170	553453	1.450
93692.0	1051.54	2.95	2.73	57300	545304	551998	-11022	-4091	767	1.434	-.176	548651	1.427
92692.0	1053.20	2.94	2.64	56773	539706	546837	-11006	-3813	621	1.463	-.184	543272	1.402
91692.0	1054.97	2.94	2.55	56246	533486	541055	-10990	-3516	476	1.492	-.191	537270	1.376
90692.0	1056.87	2.93	2.46	55718	526596	534602	-10972	-3199	330	1.521	-.199	530599	1.347
89692.0	1058.88	2.93	2.36	55190	518985	527430	-10953	-2861	185	1.551	-.207	523208	1.316
88692.0	1061.03	2.92	2.26	54662	510601	519484	-10933	-2501	39	1.581	-.215	515043	1.284
87692.0	1063.31	2.92	2.16	54134	501379	510702	-10912	-2118	-105	1.611	-.224	506041	1.249
86692.0	1065.73	2.91	2.06	53605	491335	501096	-10889	-1714	-251	1.642	-.233	496216	1.212
85692.0	1068.29	2.91	1.96	53075	480267	490468	-10865	-1284	-396	1.673	-.242	485367	1.172
84692.0	1070.09	2.84	1.92	52563	474054	484168	-10757	-1124	-496	1.686	-.262	479111	1.148
83692.0	1071.31	2.74	1.92	52062	471837	481468	-10575	-1133	-560	1.687	-.290	476652	1.137
82692.0	1072.64	2.64	1.93	51561	469214	478362	-10376	-1143	-624	1.688	-.318	473788	1.124
81692.0	1074.08	2.54	1.93	51059	466196	474860	-10160	-1154	-689	1.690	-.346	470528	1.109
80692.0	1075.62	2.43	1.94	50557	462781	470962	-9927	-1165	-753	1.691	-.375	466871	1.094
79692.0	1077.28	2.32	1.95	50055	458962	466659	-9678	-1178	-818	1.693	-.404	462810	1.077
78692.0	1079.05	2.21	1.95	49552	454723	461935	-9411	-1191	-882	1.695	-.434	458329	1.059
77692.0	1080.94	2.10	1.96	49049	450040	456766	-9127	-1205	-946	1.698	-.465	453403	1.039
76692.0	1082.95	1.98	1.96	48546	444880	451120	-8826	-1220	-1011	1.700	-.496	448000	1.019
75692.0	1085.08	1.86	1.97	48042	439207	444961	-8505	-1236	-1075	1.702	-.527	442084	.997
74692.0	1087.35	1.74	1.97	47537	432975	438243	-8164	-1253	-1139	1.705	-.559	435609	.973
73692.0	1089.75	1.61	1.98	47032	426138	430918	-7802	-1270	-1203	1.708	-.591	428528	.948
72692.0	1092.30	1.48	1.99	46526	418640	422933	-7418	-1285	-1268	1.711	-.623	420787	.922
71692.0	1095.01	1.34	1.99	46020	410429	414233	-7011	-1310	-1332	1.714	-.656	412331	.894
70692.0	1097.88	1.21	2.00	45513	401446	404762	-6579	-1331	-1396	1.717	-.689	403104	.865
69692.0	1100.92	1.06	2.01	45006	391638	394464	-6121	-1353	-1460	1.721	-.722	393051	.834
68692.0	1104.13	.92	2.01	44498	380951	383287	-5635	-1377	-1524	1.724	-.756	382119	.801
67692.0	1107.54	.77	2.02	43990	369339	371184	-5121	-1402	-1588	1.728	-.790	370262	.766
66692.0	1111.13	.61	2.03	43480	356763	358117	-4579	-1429	-1652	1.732	-.824	357440	.730

3.1-138

SMA-B-D-027(111) REV 3

Amendment 110
7/19/71

X(A) COORDINATES

TABLE 3.1-20 (CONTINUED)

CSM-112/ LM-10 L.O.I. BURN

WEIGHT LBS.	X-BAR	Y-BAR INCHES	Z-BAR	I _{XX}	I _{YY}	I _{ZZ} SLUG-FT SQ	P _{XY}	P _{XZ}	P _{YZ}	PITCH DEGREES	YAW	AVERAGE MOMENT	INERTIA/THRUST RATIO
65692.0	1114.92	.45	2.04	42970	343178	344040	-4008	-1457	-1716	1.736	-.858	343609	.693
64692.0	1118.94	.29	2.04	42460	328389	328758	-3402	-1486	-1780	1.740	-.892	328574	.653
63692.C	1123.17	.12	2.05	41548	312456	312331	-2764	-1518	-1844	1.744	-.927	312393	.612

3.1-139

SNA-8-D-027(III) REV 3

X(A)CCORDINATES

TABLE 3.1-21

CSM-112/ LM-10 C.O.I. BURN

WEIGHT LBS.	X-BAR	Y-BAR INCHES	Z-BAR	IXX	IYY	IZZ	PXY	PXZ	PYZ	PITCH DEGREES	YAW	AVERAGE MOMENT	INERTIA/THRUST RATIO
102641.1	1041.35	2.99	3.45	61579	574170	576550	-11125	-5800	2087	1.200	-.127	575560	1.570
101641.1	1042.11	2.99	3.38	61455	572426	575640	-11118	-5674	1942	1.224	-.131	574033	1.560
100641.1	1042.96	2.98	3.30	60931	570382	574031	-11110	-5532	1756	1.248	-.135	572206	1.545
99641.1	1043.90	2.98	3.22	60406	568011	572095	-11101	-5375	1651	1.273	-.140	570053	1.536
98641.1	1044.93	2.97	3.15	59881	565284	569803	-11092	-5202	1506	1.299	-.145	567543	1.522
97641.1	1046.06	2.97	3.07	59355	562168	567123	-11081	-5013	1360	1.325	-.151	564646	1.506
96641.1	1047.29	2.97	2.98	58830	558631	564022	-11070	-4808	1215	1.352	-.156	561326	1.489
95641.1	1048.62	2.96	2.90	58304	554630	560463	-11058	-4585	1070	1.379	-.163	557550	1.470
94641.1	1050.06	2.96	2.81	57778	550147	556410	-11044	-4344	924	1.406	-.169	553278	1.449
93641.1	1051.61	2.95	2.73	57251	545122	551823	-11030	-4085	779	1.435	-.176	548472	1.426
92641.1	1053.26	2.95	2.64	56725	539520	546658	-11015	-3808	633	1.463	-.183	543089	1.401
91641.1	1055.04	2.94	2.55	56197	533295	540870	-10998	-3510	488	1.492	-.190	537083	1.375
90641.1	1056.93	2.94	2.45	55670	526400	534413	-10981	-3193	342	1.522	-.198	530406	1.346
89641.1	1058.95	2.93	2.36	55142	518784	527235	-10962	-2855	197	1.552	-.206	523010	1.315
88641.1	1061.10	2.93	2.26	54614	510394	519284	-10942	-2495	52	1.582	-.214	514839	1.283
87641.1	1063.39	2.92	2.16	54085	501166	510495	-10921	-2112	-93	1.612	-.223	505830	1.248
86641.1	1065.80	2.91	2.06	53556	491114	500882	-10899	-1708	-239	1.643	-.232	495958	1.211
85641.1	1068.37	2.91	1.95	53027	480039	490247	-10875	-1277	-384	1.674	-.241	485143	1.171
84641.1	1070.17	2.85	1.92	52514	473821	483942	-10766	-1117	-483	1.686	-.262	478881	1.147
83641.1	1071.39	2.75	1.92	52014	471600	481238	-10585	-1126	-548	1.687	-.289	476419	1.136
82641.1	1072.72	2.65	1.93	51512	468573	478128	-10386	-1136	-612	1.689	-.317	473551	1.123
81641.1	1074.16	2.54	1.93	51011	465951	474622	-10170	-1147	-677	1.690	-.345	470286	1.108
80641.1	1075.71	2.44	1.94	50509	462531	470718	-9937	-1158	-741	1.692	-.374	466625	1.093
79641.1	1077.37	2.33	1.94	50007	458707	466410	-9687	-1170	-806	1.694	-.404	462559	1.076
78641.1	1079.15	2.22	1.95	49504	454463	461681	-9420	-1182	-870	1.696	-.434	458072	1.058
77641.1	1081.04	2.10	1.95	49001	449773	456506	-9136	-1197	-934	1.698	-.464	453139	1.038
76641.1	1083.05	1.98	1.96	48497	444607	450854	-8834	-1212	-998	1.701	-.495	447731	1.018
75641.1	1085.18	1.86	1.97	47993	438927	444688	-8514	-1226	-1063	1.703	-.526	441807	.996
74641.1	1087.45	1.74	1.97	47489	432688	437962	-8173	-1245	-1127	1.706	-.558	435325	.972
73641.1	1089.86	1.61	1.98	46984	425842	430629	-7811	-1263	-1191	1.708	-.590	428236	.947
72641.1	1092.41	1.48	1.98	46478	418336	422635	-7427	-1282	-1255	1.711	-.623	420486	.921
71641.1	1095.12	1.35	1.99	45972	410115	413926	-7019	-1302	-1320	1.715	-.655	412020	.893
70641.1	1097.99	1.21	2.00	45465	401122	404445	-6587	-1323	-1384	1.718	-.688	402783	.864
69641.1	1101.04	1.07	2.00	44958	391303	394136	-6129	-1345	-1448	1.721	-.722	392719	.833
68641.1	1104.26	.92	2.01	44450	380604	382947	-5643	-1365	-1512	1.725	-.755	381776	.800
67641.1	1107.67	.77	2.02	43941	368579	370832	-5129	-1394	-1576	1.729	-.789	369906	.765
66641.1	1111.27	.61	2.03	43432	356390	357751	-4587	-1420	-1640	1.733	-.823	357070	.729

3.1-140

SNA-8-D-027(III) REV 3

Amendment 110
7/19/71

X (A) COORDINATES				TABLE 3.1-21 (CONTINUED)						CSM-112/ LM-10 D.O.I. BURN			
WEIGHT LBS.	X-BAR	Y-BAR INCHES	Z-BAR	IXX	IYY	IZZ SLUG-FT SQ	PXY	PXZ	PYZ	PITCH DEGREES	YAW	AVERAGE MOMENT	INERTIA/THRUST RATIO
65641.1	1115.06	.45	2.03	42922	342790	343659	-4016	-1446	-1704	1.737	-.856	343225	.691
64641.1	1119.08	.29	2.04	42411	327985	328361	-3410	-1478	-1768	1.741	-.892	328173	.652
63641.1	1123.32	.12	2.05	41900	312034	311917	-2771	-1509	-1832	1.745	-.926	311976	.611

3.1-141

SNA-8-D-027 (III) REV 3

X(A) COORDINATES

TABLE 3.1-22

CSM-112 CIRCULARIZATION BURN

WEIGHT LBS.	X-BAR	Y-BAR INCHES	Z-BAR	IXX	IYY	IZZ SLUG-FT SQ	PXY	PXZ	PYZ	PITCH DEGREES	YAW	AVERAGE MOMENT	INERTIA/THRUST RATIO
65712.9	933.16	4.91	5.04	35650	78252	80043	-2171	465	2481	-.734	1.865	79147	.450
64712.9	932.68	4.94	4.94	35130	77588	79809	-2161	424	2338	-.695	1.892	78698	.449
63712.9	932.30	4.96	4.85	34610	77006	79656	-2152	392	2196	-.651	1.916	78331	.449
62712.9	932.03	4.99	4.75	34085	76485	79565	-2146	365	2053	-.602	1.939	78025	.448
61712.9	931.87	5.01	4.65	33568	76006	79517	-2143	356	1911	-.548	1.958	77761	.447
60712.9	931.82	5.04	4.54	33047	75548	79489	-2142	352	1768	-.488	1.975	77519	.446
59712.9	931.90	5.07	4.44	32525	75089	79461	-2144	359	1626	-.424	1.989	77275	.445
58712.9	932.10	5.09	4.32	32003	74605	79408	-2148	377	1484	-.354	1.999	77007	.442
57712.9	932.44	5.12	4.21	31481	74071	79306	-2155	406	1342	-.279	2.006	76688	.439
56712.9	932.92	5.15	4.09	30959	73460	79126	-2165	447	1199	-.198	2.009	76293	.434
55712.9	933.55	5.19	3.97	30436	72743	78841	-2178	500	1058	-.113	2.008	75792	.429
54712.9	934.33	5.22	3.84	29912	71889	78420	-2195	567	916	-.023	2.004	75154	.422
53712.9	935.28	5.25	3.70	29388	70865	77828	-2215	648	774	.072	1.995	74346	.414
52712.9	936.41	5.29	3.57	28864	69634	77031	-2239	744	632	.171	1.983	73332	.403
51712.9	937.73	5.32	3.42	28339	68158	75989	-2267	857	491	.275	1.966	72073	.392
50712.9	939.24	5.36	3.27	27814	66388	74653	-2299	986	349	.382	1.944	70520	.378
49712.9	940.95	5.40	3.12	27288	64306	73005	-2335	1131	208	.493	1.919	68656	.362
48712.9	942.91	5.44	2.96	26762	61813	70947	-2377	1297	67	.607	1.890	66380	.344
47712.9	943.47	5.38	2.91	26255	60506	69557	-2429	1367	-29	.638	1.845	65032	.335
46712.9	942.94	5.26	2.94	25761	60413	68989	-2463	1374	-93	.615	1.795	64701	.335
45712.9	942.54	5.13	2.97	25267	60351	68452	-2488	1380	-156	.593	1.738	64401	.334
44712.9	942.25	5.00	3.00	24773	60316	67942	-2506	1384	-219	.572	1.675	64129	.334
43712.9	942.10	4.86	3.04	24279	60302	67452	-2517	1386	-282	.552	1.605	63877	.333
42712.9	942.07	4.71	3.07	23784	60301	66975	-2519	1336	-345	.532	1.525	63638	.332
41712.9	942.17	4.58	3.11	23288	60303	66500	-2515	1384	-408	.514	1.446	63402	.330
40712.9	942.40	4.40	3.15	22792	60295	66016	-2502	1381	-471	.497	1.357	63156	.328
39712.9	942.79	4.23	3.19	22296	60263	65506	-2480	1375	-534	.482	1.260	62884	.326
38712.9	943.34	4.05	3.24	21799	60188	64953	-2449	1367	-597	.467	1.157	62571	.323
37712.9	944.07	3.87	3.28	21302	60050	64337	-2408	1356	-659	.455	1.047	62193	.319
36712.9	944.95	3.67	3.33	20804	59824	63632	-2355	1343	-721	.444	.929	61728	.314
35712.9	946.13	3.48	3.38	20305	59485	62813	-2290	1326	-784	.436	.805	61149	.307
34712.9	947.51	3.24	3.43	19805	59002	61850	-2210	1306	-846	.430	.673	60426	.300
33712.9	949.15	3.01	3.49	19305	58343	60710	-2114	1282	-907	.426	.535	59527	.292
32712.9	951.08	2.76	3.55	18804	57474	59359	-2002	1255	-969	.425	.390	58416	.281
31712.9	953.33	2.49	3.61	18301	56358	57760	-1870	1222	-1030	.427	.240	57059	.270
30712.9	955.42	2.21	3.68	17798	54958	55877	-1718	1185	-1052	.431	.084	55417	.256
29712.9	958.88	1.91	3.76	17294	53237	53671	-1544	1142	-1152	.438	-.077	53454	.241

3.1-142

SNA-8-D-027(111) REV 3

Amendment 110
7/19/71

XIA) COORDINATES				TABLE 3.1-22 (CONTINUED)				CSM-112 CIRCULARIZATION BURN					
WEIGHT LBS.	X-BAR	Y-BAR INCHES	Z-BAR	IXX	IYY	IZZ SLUG-FT SQ	PXY	PXZ	PYZ	PITCH DEGREES	YAW	AVERAGE MOMENT	INERTIA/THRUST RATIO
28712.9	562.25	1.59	3.83	16788	51151	51100	-1347	1094	-1213	.449	-.242	51126	.225
27712.9	566.11	1.25	3.92	16280	48581	48043	-1120	1036	-1273	.462	-.411	48312	.206
26712.9	570.48	.88	4.01	15772	45520	44493	-863	976	-1333	.478	-.582	45006	.186

3.1-143

SNA-8-D-027(III) REV 3

X(A) COORDINATES

TABLE 3.1-23

CSM-112 PLANE CHANGE 1

WEIGHT LBS.	X-BAR	Y-BAR INCHES	Z-BAR	IXX	IYY	IZZ SLUG-FT SQ	PXY	PXZ	PYZ	PITCH DEGREES	YAW	AVERAGE MOMENT	INERTIA/THRUST RATIO
65472.5	933.18	4.96	5.01	35470	78127	79950	-2181	482	2537	-.720	1.890	79039	.449
64472.9	932.70	4.98	4.92	34950	77464	79716	-2171	441	2394	-.680	1.918	78590	.448
63472.9	932.32	5.01	4.82	34429	76882	79563	-2162	405	2252	-.636	1.943	78222	.448
62472.9	932.05	5.03	4.72	33909	76361	79473	-2156	386	2109	-.587	1.966	77917	.448
61472.9	931.88	5.06	4.62	33388	75882	79424	-2153	372	1967	-.532	1.986	77653	.447
60472.9	931.84	5.09	4.52	32866	75424	79397	-2152	365	1825	-.472	2.003	77411	.446
59472.9	931.92	5.12	4.41	32345	74965	79369	-2153	376	1682	-.407	2.017	77167	.444
58472.9	932.12	5.15	4.30	31823	74481	79316	-2158	394	1540	-.337	2.028	76898	.441
57472.9	932.46	5.18	4.18	31300	73947	79213	-2165	423	1398	-.261	2.035	76580	.438
56472.9	932.94	5.21	4.06	30777	73335	79033	-2175	464	1256	-.180	2.039	76184	.434
55472.9	933.57	5.24	3.93	30254	72618	78748	-2189	518	1114	-.094	2.039	75683	.428
54472.9	934.36	5.27	3.80	29731	71763	78326	-2206	585	973	-.003	2.034	75044	.421
53472.9	935.32	5.31	3.67	29207	70738	77734	-2227	667	831	.092	2.026	74236	.413
52472.9	936.45	5.35	3.53	28682	69506	76935	-2252	763	689	.192	2.014	73221	.403
51472.9	937.77	5.38	3.38	28157	68029	75891	-2280	876	548	.296	1.997	71960	.391
50472.9	939.30	5.42	3.23	27632	66257	74554	-2314	1006	407	.404	1.976	70405	.377
49472.9	941.02	5.46	3.08	27106	64173	72904	-2351	1152	266	.515	1.951	68538	.361
48472.9	942.98	5.51	2.91	26579	61676	70843	-2394	1319	125	.630	1.921	66259	.343
47472.9	943.55	5.45	2.87	26072	60369	69452	-2446	1389	28	.661	1.876	64911	.334
46472.9	943.02	5.33	2.90	25579	60276	68885	-2480	1396	-35	.638	1.827	64581	.334
45472.9	942.61	5.20	2.93	25085	60215	68349	-2505	1401	-98	.617	1.771	64282	.334
44472.9	942.33	5.07	2.96	24591	60181	67839	-2523	1405	-162	.596	1.708	64010	.333
43472.9	942.18	4.93	2.99	24057	60167	67350	-2533	1407	-225	.577	1.639	63758	.332
42472.9	942.15	4.78	3.03	23602	60166	66873	-2535	1407	-288	.558	1.563	63519	.331
41472.9	942.25	4.63	3.06	23107	60168	66398	-2531	1406	-351	.540	1.481	63283	.330
40472.9	942.49	4.47	3.10	22611	60160	65914	-2518	1402	-414	.524	1.392	63037	.328
39472.9	942.88	4.30	3.14	22115	60127	65404	-2497	1397	-477	.509	1.296	62765	.325
38472.9	943.44	4.12	3.18	21619	60051	64850	-2466	1389	-540	.495	1.192	62451	.322
37472.9	944.17	3.94	3.23	21121	59912	64233	-2425	1379	-602	.483	1.082	62072	.318
36472.9	945.11	3.74	3.28	20624	59685	63527	-2372	1365	-665	.473	.965	61606	.313
35472.9	946.26	3.53	3.33	20125	59343	62706	-2307	1349	-727	.465	.840	61024	.306
34472.9	947.65	3.31	3.38	19626	58857	61740	-2228	1330	-789	.459	.708	60299	.299
33472.9	949.30	3.08	3.43	19126	58195	60597	-2133	1307	-851	.456	.570	59396	.290
32472.9	951.25	2.83	3.49	18625	57321	59242	-2021	1280	-913	.455	.425	58281	.280
31472.9	953.52	2.57	3.56	18123	56199	57637	-1890	1248	-974	.457	.274	56918	.269
30472.9	956.14	2.29	3.62	17620	54792	55747	-1739	1212	-1036	.462	.117	55270	.255
29472.9	959.13	1.99	3.69	17116	53062	53532	-1566	1170	-1097	.470	-.044	53297	.240

3.1-144

SNA-8-D-027(III) REV 3

Amendment 110
7/19/71

X(A) COORDINATES

TABLE 3.1-23 (CONTINUED)

CSM-112 PLANE CHANGE 1

WEIGHT LBS.	X-BAR	Y-BAR INCHES	Z-BAR	IXX	IYY	IZZ SLUG-FT SQ	PXY	PxZ	PYZ	PITCH DEGREES	YAW	AVERAGE MOMENT	INERTIA/THRUST RATIO
28472.9	562.54	1.67	3.77	16610	50965	50950	-1370	1123	-1157	.480	-.210	50958	.224
27472.9	566.45	1.33	3.85	16103	48380	47878	-1145	1065	-1218	.494	-.379	48129	.205
26472.9	570.87	.96	3.94	15595	45300	44310	-889	1007	-1278	.511	-.551	44805	.185

3.1-145

SNA-8-D-027(III) REV 3

XIA) COORDINATES

TABLE 3.1-24

CSM-112 T.E.I. BURN

WEIGHT LBS.	X-BAR	Y-BAR INCHES	Z-BAR	IXX	IYY	IZZ SLUG-FT SQ	PXY	PXZ	PYZ	PITCH DEGREES	YAW	AVERAGE MOMENT	INERTIA/THRUST RATIO
65540.8	933.67	5.07	4.90	35270	77931	74795	-2031	254	2594	-.644	1.938	78663	.446
64540.8	933.20	5.10	4.81	34744	77274	79567	-2019	213	2452	-.603	1.967	78421	.445
63540.8	932.82	5.12	4.71	34228	76696	79420	-2011	181	2310	-.558	1.993	78058	.445
62540.8	932.56	5.15	4.61	33707	76179	79333	-2004	155	2167	-.507	2.017	77756	.444
61540.8	932.41	5.18	4.51	33186	75702	79287	-2001	146	2025	-.451	2.038	77494	.444
60540.8	932.37	5.21	4.40	32664	75244	79260	-2000	143	1883	-.391	2.056	77252	.442
59540.8	932.46	5.24	4.29	32142	74784	79230	-2002	150	1741	-.325	2.070	77007	.441
58540.8	932.67	5.27	4.18	31619	74290	79174	-2007	169	1599	-.253	2.082	76735	.438
57540.8	933.02	5.30	4.06	31097	73757	79067	-2015	200	1457	-.177	2.090	76412	.435
56540.8	933.51	5.33	3.93	30573	73138	78880	-2026	242	1316	-.096	2.094	76009	.430
55540.8	934.15	5.37	3.81	30050	72412	78586	-2041	298	1174	-.010	2.095	75499	.425
54540.8	934.95	5.41	3.68	29526	71546	78153	-2060	368	1032	.081	2.091	74849	.418
53540.8	935.91	5.44	3.54	29001	70507	77547	-2082	452	891	.177	2.083	74027	.409
52540.8	937.06	5.48	3.40	28476	69259	76733	-2109	551	750	.277	2.071	72996	.399
51540.8	938.39	5.52	3.25	27951	67763	75671	-2140	667	609	.381	2.055	71717	.387
50540.8	939.92	5.56	3.10	27425	65570	74312	-2176	800	468	.488	2.034	70141	.373
49540.8	941.66	5.61	2.94	26898	63861	72639	-2216	950	327	.599	2.010	68250	.357
48540.8	943.63	5.65	2.77	26371	61338	70551	-2263	1121	186	.713	1.980	65544	.339
47540.8	944.21	5.60	2.72	25864	60023	69152	-2315	1192	89	.745	1.937	64587	.330
46540.8	943.69	5.48	2.75	25371	59937	68593	-2347	1198	25	.725	1.889	64265	.330
45540.8	943.30	5.36	2.78	24878	59881	68062	-2371	1203	-37	.706	1.835	63972	.330
44540.8	943.04	5.23	2.80	24384	59851	67557	-2387	1206	-101	.688	1.775	63704	.329
43540.8	942.90	5.09	2.83	23891	59839	67070	-2396	1207	-164	.671	1.708	63454	.328
42540.8	942.89	4.95	2.86	23396	59839	66594	-2398	1207	-228	.654	1.634	63216	.327
41540.8	943.01	4.80	2.90	22902	59839	66118	-2392	1206	-291	.639	1.554	62979	.326
40540.8	943.27	4.65	2.93	22407	59828	65630	-2379	1202	-354	.625	1.468	62729	.324
39540.8	943.68	4.48	2.97	21911	59789	65115	-2357	1197	-418	.612	1.374	62452	.321
38540.8	944.25	4.31	3.00	21415	59706	64555	-2326	1190	-481	.601	1.274	62131	.318
37540.8	945.01	4.13	3.04	20919	59557	63928	-2285	1180	-544	.591	1.166	61742	.314
36540.8	945.96	3.94	3.08	20422	59317	63210	-2232	1168	-606	.583	1.051	61263	.308
35540.8	947.13	3.74	3.13	19924	58960	62374	-2168	1153	-669	.577	.929	60667	.302
34540.8	948.55	3.52	3.18	19425	58456	61390	-2089	1136	-732	.573	.800	59923	.295
33540.8	950.23	3.30	3.22	18926	57771	60225	-1996	1115	-794	.572	.665	58998	.286
32540.8	952.20	3.06	3.28	18426	56871	58844	-1885	1090	-856	.572	.522	57858	.276
31540.8	954.50	2.80	3.33	17925	55719	57211	-1756	1062	-918	.576	.374	56465	.264
30540.8	957.14	2.53	3.39	17423	54278	55287	-1607	1025	-980	.582	.220	54782	.251
29540.8	960.16	2.24	3.46	16920	52508	53033	-1437	992	-1042	.591	.061	52771	.236

3.1-146

SMA-8-D-027(III) REV 3

Amendment 110
7/19/71

X(A) COORDINATES				TABLE 3.1-24 (CONTINUED)					CSM-112 T.E.I. BURN				
WEIGHT LBS.	X-BAR	Y-BAR INCHES	Z-BAR	Ixx	Iyy	IZZ SLUG-FT SQ	PXY	PXZ	PYZ	PITCH DEGREES	YAW	AVERAGE MOMENT	INERTIA/THRUST RATIO
28540.8	963.60	1.93	3.52	16416	50367	50407	-1245	949	-1103	.602	-.102	50387	.219
27540.8	967.53	1.60	3.60	15911	47732	47286	-1023	900	-1164	.616	-.269	47509	.201
26540.8	971.98	1.24	3.68	15404	44595	43662	-772	845	-1225	.633	-.439	44129	.181

3.1-147

SMA-8-D-027(III) REV 3

X(Y) COORDINATES

TABLE 3.1-25

LM-10 PRE P.D.I. TG TOUCHDOWN

WEIGHT LBS.	X-BAR	Y-BAR INCHES	Z-BAR	Ixx	Iyy	IZZ SLUG-FT SQ	PXY	PXZ	PYZ	PILOT ROLL DEGREES	PILOT PITCH DEGREES
36658.3	184.98	.40	-.39	27261	28465	27061	83	809	174	.749	.723
36133.5	185.23	.41	-.39	26931	28253	26924	83	809	175	.750	.723
35608.7	185.47	.41	-.40	26600	28038	26783	83	809	176	.751	.724
35083.5	185.69	.42	-.40	26270	27821	26640	82	809	177	.754	.726
34559.1	185.89	.42	-.41	25939	27602	26496	82	809	177	.756	.728
34034.3	186.10	.43	-.41	25608	27382	26351	82	809	178	.759	.730
33509.5	186.31	.43	-.41	25278	27161	26204	82	809	179	.762	.732
32984.6	186.52	.43	-.42	24947	26940	26057	82	810	180	.765	.734
32459.8	186.74	.44	-.42	24617	26717	25909	82	810	180	.769	.736
31935.0	186.98	.44	-.43	24286	26492	25759	82	810	181	.772	.739
31410.2	187.24	.45	-.43	23955	26265	25606	81	810	182	.774	.740
30885.4	187.52	.45	-.43	23625	26035	25450	81	810	183	.777	.742
30360.6	187.83	.46	-.44	23294	25800	25290	81	810	183	.779	.743
29835.8	188.17	.47	-.44	22964	25559	25123	80	811	184	.781	.744
29311.0	188.54	.47	-.45	22633	25310	24949	80	811	185	.782	.745
28786.2	188.94	.48	-.45	22303	25053	24767	79	811	186	.783	.745
28261.4	189.39	.48	-.46	21972	24785	24573	79	812	187	.783	.744
27736.5	189.88	.49	-.47	21641	24505	24368	78	812	187	.783	.743
27211.7	190.41	.50	-.47	21311	24212	24149	77	813	188	.782	.741
26686.9	190.99	.50	-.48	20980	23900	23912	76	814	189	.781	.739
26162.1	191.62	.51	-.48	20650	23580	23666	75	814	190	.779	.737
25637.3	192.29	.52	-.49	20319	23244	23405	74	815	190	.777	.734
25112.5	193.02	.53	-.50	19988	22893	23128	73	816	191	.774	.730
24587.7	193.81	.54	-.50	19658	22526	22836	71	818	192	.771	.726
24062.9	194.65	.54	-.51	19327	22143	22527	70	819	193	.767	.722
23538.1	195.54	.55	-.52	18996	21743	22201	68	820	193	.763	.717
23013.3	196.50	.56	-.53	18666	21325	21858	66	822	194	.759	.712
22488.4	197.52	.57	-.54	18335	20891	21498	64	823	195	.754	.706
21963.6	198.60	.58	-.55	18005	20438	21121	62	825	196	.749	.701
21438.8	199.75	.59	-.55	17674	19969	20725	60	827	197	.744	.695
20914.0	200.97	.61	-.56	17343	19481	20312	57	829	197	.738	.689
20389.2	202.27	.62	-.58	17013	18974	19879	55	831	198	.733	.683
19864.4	203.64	.63	-.59	16682	18445	19425	52	834	199	.727	.677
19339.6	205.09	.64	-.60	16352	17899	18953	49	836	200	.722	.670
18814.8	206.62	.66	-.61	16021	17334	18463	46	839	201	.716	.664
18290.0	208.24	.67	-.62	15690	16750	17953	42	842	201	.710	.658
17766.0	209.95	.69	-.64	15360	16144	17422	39	845	202	.705	.652

3.1-148

SNA-8-D-027(III) REV 3

Amendment 110
7/19/71

X (E) COORDINATES

TABLE 3.1-26 LM-10 AS LUNAR LIFTOFF TO INSERTION

WEIGHT LBS.	X-BAR	Y-BAR INCHES	Z-BAR	IXX	IYY	IZZ SLUG-FT SQ.	PXY	PXZ	PYZ	ROLL MOMENT OFFSET (DEG./SEC. SQ.)	PITCH MOMENT
10349.1	243.78	.06	2.82	6743	3405	5955	64	175	-34	.162	5.909
10588.5	244.17	.06	2.89	6565	3390	5762	64	177	-34	.168	5.647
10328.0	244.58	.06	2.96	6386	3375	5568	64	174	-34	.173	5.369
10067.4	245.01	.06	3.03	6207	3358	5374	64	171	-34	.180	5.073
9806.8	245.46	.06	3.12	6028	3341	5179	64	168	-34	.186	4.759
9546.3	245.93	.06	3.20	5849	3323	4983	64	165	-34	.194	4.424
9285.7	246.44	.06	3.29	5670	3304	4786	64	162	-34	.202	4.066
9025.1	246.97	.06	3.39	5491	3283	4588	64	158	-34	.210	3.683
8764.6	247.53	.06	3.49	5312	3262	4389	64	154	-34	.220	3.272
8504.0	248.13	.06	3.59	5133	3239	4189	64	150	-34	.230	2.830
8243.4	248.77	.06	3.71	4954	3215	3987	64	146	-34	.242	2.353
7982.8	249.45	.06	3.83	4775	3189	3783	64	142	-34	.255	1.837
7722.3	250.17	.06	3.96	4596	3161	3578	64	137	-34	.269	1.277
7461.7	250.95	.06	4.09	4416	3132	3371	64	132	-34	.285	.667
7201.1	251.78	.06	4.24	4237	3100	3162	64	126	-34	.304	-.000
6940.6	252.67	.06	4.40	4058	3066	2951	64	120	-34	.326	-.733
6680.0	253.63	.06	4.57	3878	3030	2737	64	114	-34	.351	-1.542
6419.4	254.67	.06	4.76	3699	2990	2520	64	107	-34	.381	-2.438
6158.9	255.80	.06	4.96	3519	2947	2300	64	100	-34	.417	-3.437
5898.3	257.03	.06	5.18	3339	2900	2076	64	92	-34	.462	-4.555

3.1-149

SNA-8-D-027(III) REV 3

Amendment 110
7/19/71

WEIGHT LBS.	X COORDINATES			TABLE 3.1-27		LM-10 T.P.I.			
	X-BAR	Y-BAR	Z-BAR	IXX	IYY	IZZ	PXY	PXZ	PYZ
	INCHES			SLUG-FT SQ					
5843.5	256.79	.06	5.23	3322	2886	2052	64	94	-33
5817.5	256.92	.06	5.25	3304	2881	2029	64	93	-33
5791.4	257.05	.06	5.28	3286	2876	2006	64	92	-33
5765.4	257.18	.06	5.30	3268	2871	1984	64	91	-33
5739.4	257.31	.06	5.33	3250	2866	1961	64	91	-33
5713.3	257.45	.06	5.35	3232	2861	1939	64	90	-33
5687.3	257.58	.06	5.37	3214	2856	1916	64	89	-33
5661.2	257.72	.06	5.40	3196	2851	1893	64	88	-33
5635.2	257.86	.06	5.42	3178	2846	1870	64	87	-33
5609.2	257.99	.06	5.45	3160	2841	1847	64	86	-33
5594.2	258.05	.19	5.46	3149	2839	1834	60	86	-34

3.1-150

SNA-8-D-027(III) REV 3



P P P P P P P P P P P P P P P

P P P P P P P P P P P P P P

P P P P P P P P P P P P P P

P P P P P P P P P P P P P P

P P P

3.2 MISSION J2
(GSM 113/LM-11)

M M M M M M M M M M M M M M M

SUPPLEMENTARY DATA APPLICABLE TO SEQUENTIAL MASS PROPERTIES TABLES

General Comments to be applied to Tables 3.2-1 through 3.2-8:

Inertia data dispersions are $\pm 10\%$.

Dispersions shall be used as 3σ deviation values.

All initial propellant weights are total tanked.

The (+) or (-) sign following the name of an item indicates that the item is added to or subtracted from the preceding total.

Table 3.2-1

SM/SPS gimbal angles for SPS abort sequence are: Pitch = -0.470
Yaw = 1.898

Table 3.2-2

LM propellants are in high end of the tanks, (greatest X-c.g. station), for all docked configuration where the CSM is the controlling vehicle. The Mass Spectrometer and Gamma-Ray Spectrometer are shown deployed after each SPS firing following D.O.I. For all other summations the M.S. and G.R. Spectrometers are not deployed. The following are the individual mass properties for the M.S. and G.R. Spectrometers in Apollo Coordinates.

	Weight (lb)	X-Bar (in)	Y-Bar (in)	Z-Bar (in)
Gamma-Ray Retracted	45.4	865.1	33.0	-57.0
Gamma-Ray Deployed	28.0 17.4	865.1 865.1	231.3 132.2	-312.4 -184.7
Mass Spectrometer Retracted	47.4	863.1	55.8	-40.5
Mass Spectrometer Deployed	27.4 20.0	863.1 863.1	341.7 198.8	-149.4 -94.9

Tables 3.2-7 and 3.2-8

CSM and LM consumables changes are presented in Tables 3.2-7 and 3.2-8, respectively.

W
H
E
E
L
L
E
N
G
T
H
S
O
F
T
W
A
R
E
D
E
V
E
L
O
P
E
D
B
Y
S
P
A
C
E
S
H
I
P
S
O
F
T
W
A
R
E
C
O
R
P
O
R
A
T
I
O
N

Amendment 114
9/15/71

XE COORDINATES TABLE 3.2-1
LM-11 EXPECTED SEQUENTIAL MASS PROPERTIES

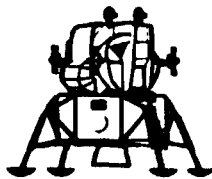

DESCRIPTION	S	WEIGHT POUNDS	C. G. INCHES			INERTIAS SLUG-FT ²			PRODUCTS SLUG-FT ²			DISPERSIONS LA/IN			
			X	Y	Z	IXX	IYY	IZZ	PXY	PXZ	PYZ	DW	DX	DY	DZ
ASCENT STAGE	+	4728.8	257.5	-0.2	2.9	2757	2660	1568	61	111	-13	25.0	1.0	.5	.5
34 LM RCS FUEL	+	102.4	279.1	44.6	14.5	0	0	0	0	0	0	1.0	1.0	.1	.1
37 LM RCS FUEL	+	102.4	279.1	-44.6	-14.5	0	0	0	0	0	0	1.0	1.0	.1	.1
29 LM RCS OXY	+	200.3	275.4	-44.6	14.5	0	1	1	0	0	0	2.0	1.0	.1	.1
31 LM RCS OXY	+	200.3	275.4	44.6	-14.5	0	1	1	0	0	0	2.0	1.0	.1	.1
22 LM APS FUEL	+	2008.3	228.0	-71.3	.0	0	0	0	0	0	0	5.4	1.0	.5	.5
19 LM APS OXY	+	3217.4	228.0	44.5	.0	0	0	0	0	0	0	8.7	1.0	.5	.5
ASCENT STAGE		10559.9	244.0	-0.1	1.3	6628	3310	6025	58	150	-40	27.2	.6	.3	.3
DESCENT STAGE	+	6159.6	156.4	2.9	-7.7	6833	4859	3669	124	-88	251	29.0	1.0	.5	.5
77 LM DPS FUEL	+	3749.3	160.4	54.0	.0	0	8	8	0	0	0	7.1	1.0	.5	.5
80 LM DPS FUEL	+	3749.4	160.4	-54.0	.0	0	8	8	0	0	0	7.1	1.0	.5	.5
71 LM DPS OXY	+	5993.4	160.4	.0	54.0	0	13	13	0	0	0	12.7	1.0	.5	.5
74 LM DPS OXY	+	5993.5	160.4	.0	-54.0	0	13	13	0	0	0	12.7	1.0	.5	.5
DESCENT STAGE		25645.2	159.4	.7	-1.8	19165	12522	8456	112	-56	228	35.6	.5	.2	.2
LM AT EARTH LAUNCH		36205.1	184.1	.5	-0.9	25810	27392	26025	63	523	183	44.8	.4	.2	.2

3.2-2

SMA-8-0-027(III) REV 3

U
N
I
T
E
D
S
T
A
T
E
S
O
F
A
M
E
R
I
C
A

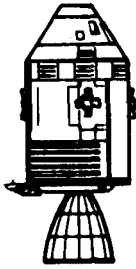

XA COORDINATES TABLE 3.2-2
CSM 113/LM-11 EXPECTED SEQUENTIAL MASS PROPERTIES

Amendment 114
9/15/71

DESCRIPTION	S	WEIGHT POUNDS	C. G. INCHES			INERTIAS SLUG-FT ²			PRODUCTS SLUG-FT ²			DISPERSIONS LB/IN			
			X	Y	Z	I _{XX}	I _{YY}	I _{ZZ}	P _{XY}	P _{XZ}	P _{YZ}	D _W	D _X	D _Y	D _Z
SLA RING	+	98.0	835.7	2.0	-6.6	120	65	56	0	0	0	.0	.0	.0	.0
SERVICE MODULE	+	13537.8	917.3	1.5	1.0	9760	14474	13175	-188	517	-1673	25.0	1.0	.5	.5
COMMAND MODULE	+	12874.2	1040.9	-.1	5.6	5870	5427	4871	46	-411	-14	25.0	1.0	.5	.5
CSM LESS SPS PROPELLANT		26510.0	977.0	.7	3.2	15785	42181	40288	-427	945	-1697	35.4	.7	.4	.4
43 SM SPS F-STORE	+	6756.7	904.0	-14.8	-47.8	0	1415	1915	0	0	0	59.0	1.0	.5	.5
46 SM SPS U-STORE	+	10768.4	903.9	14.8	47.8	0	3047	3047	0	0	0	121.0	1.0	.5	.5
49 SM SPS F-SUMP	+	8868.7	906.8	-48.3	-6.6	0	2608	2608	0	0	0	59.0	1.0	.5	.5
52 SM SPS U-SUMP	+	14194.4	907.0	48.3	6.6	0	4210	4210	0	0	0	121.0	1.0	.5	.5
SM WITH SPS PROPELLANT		54229.5	908.4	6.2	4.4	30512	35384	37439	-263	356	2272	192.0	.5	.3	.3
CSM AT EARTH LAUNCH		67105.7	933.8	5.0	4.6	36475	80223	81809	-2098	295	2241	193.6	.4	.2	.2

3.2-3

SMA-8-0-027(III) REV 3

Amendment 114
9/15/71

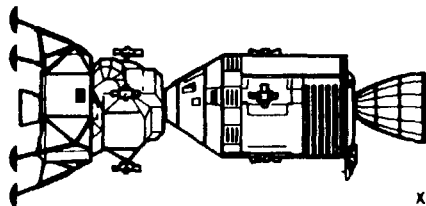

XA COORDINATES
TABLE 3.2-2(CONTINUED)
CSM 113/LM-11 EXPECTED SEQUENTIAL MASS PROPERTIES

DESCRIPTION	S	WEIGHT POUNDS	C. G. INCHES			INERTIAS SLUG-FT ²			PRODUCTS SLUG-FT ²			DISPERSIONS LB/IN			
			X	Y	Z	I _{XX}	I _{YY}	I _{ZZ}	P _{XY}	P _{XZ}	P _{YZ}	D _W	D _X	D _Y	D _Z
CSM AT EARTH LAUNCH		67103.7	933.8	5.0	4.6	36475	80223	81809	-2098	295	2241	193.6	.4	.2	.2
LM AT EARTH LAUNCH		36205.1	983.6	.5	-9	25810	27392	26025	63	523	183	44.8	.4	.2	.2
SLA (EXCLUDING RING)		3960.9	638.9	.6	-2	9988	12692	12670	-84	75	38	25.0	1.0	.5	.5
LES		9131.1	1298.5	.0	-9	844	28487	28469	5	480	0	25.0	1.0	.5	.5
CSM+LM+SLA+LES AT LAUNCH		116400.8	843.5	3.1	2.3	73435	1238837	1238960	3387	8580	2619	201.9	.3	.2	.2
CSM+LM+SLA AT E.O.I.		107269.7	804.7	3.3	2.6	72549	767529	767673	6353	11225	2598	200.3	.4	.2	.2
CSM+LM+SLA PRE TRANS/DOCK		107270.1	804.7	3.3	2.6	72555	767594	767740	6334	11227	2600	200.3	.4	.2	.2
CSM AT TRANS/DOCK		67033.5	933.9	5.0	4.7	36405	80191	81789	-2109	300	2261	193.6	.4	.2	.2
LM AT TRANS/DOCK		36202.4	1238.2	-6	.9	25805	26098	27104	-487	211	-500	44.8	.4	.3	.1
CSM/LM DOCKED		103235.9	1040.6	3.1	3.3	62442	576271	578960	-11219	-5338	1868	198.7	.4	.2	.2
CM EQUIP.RELOC.1	-	490.3	1042.5	-8.7	-12.0	34	6	31	0	1	1	.0	.0	.0	.0
CM EQUIP.RELOC.1	+	490.3	1033.6	-8.1	-13.9	28	32	40	-8	7	-1	.0	.0	.0	.0
SIM DOOR	-	160.0	912.1	43.2	-59.5	20	65	85	0	0	0	.0	.0	.0	.0
CM GASEOUS O2	+	5.5	1168.7	13.0	-7.5	0	0	0	0	0	0	.0	.0	.0	.0
CSM/LM PRE L.O.I.		102838.3	1041.0	3.0	3.4	62051	574768	577524	-11055	-5610	2009	198.7	.4	.2	.2
CSM/LM POST L.O.I.		76538.1	1083.0	2.0	1.9	48415	444474	450644	-8672	-998	-1103	198.7	.7	.2	.2

3.2-4

SMA-8-D-027(III) REV 3

U
N
I
T
E
D
S
T
A
T
E
S
O
F
A
M
E
R
I
C
A

W
 H
 E
 L
 L
 I
 N
 G
 S
 P
 E
 C
 I
 F
 I
 C
 A
 T
 I
 O
 N

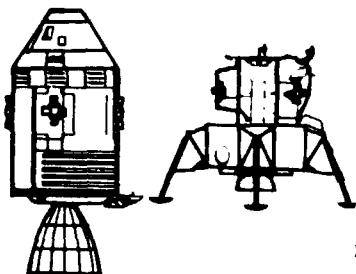

XA COORDINATES TABLE 3.2-2 (CONTINUED)
 CSM 113/LM-11 EXPECTED SEQUENTIAL MASS PROPERTIES

Amendment 114
 9/15/71

DESCRIPTION	S	WEIGHT POUNDS	C. G. INCHES			INERTIAS SLUG-FT ²			PRODUCTS SLUG-FT ²			DISPERSIONS LB/IN			
			X	Y	Z	I _{XX}	I _{YY}	I _{ZZ}	P _{XY}	P _{XZ}	P _{YZ}	DW	DX	DY	DZ
CSM/LM PRE D.O.I.		76487.2	1083.1	2.0	1.9	48367	444200	450377	-8681	-991	-1091	198.7	.7	.2	.2
CSM/LM POST D.O.I.		74925.8	1086.6	1.8	1.9	47579	434950	440368	-8161	-1014	-1192	198.7	.7	.2	.2
DEPLOY M.S. AND G.R.		74925.8	1086.6	2.0	1.8	49623	435801	441561	-9025	-370	-2064	198.7	.7	.2	.2
2 CREW+EQUIP, CM-LM	-	485.0	1041.9	14.0	-12.2	24	8	24	-3	3	-2	.0	.0	.0	.0
EQUIP.XFR, LM-CM 1	+	1.1	1018.0	24.5	-15.0	0	0	0	0	0	0	.0	.0	.0	.0
CM EQUIP.RELOC.2	-	174.6	1017.4	-3.3	-18.6	11	12	11	-2	2	-1	.0	.0	.0	.0
CM EQUIP.RELOC.2	+	174.6	1041.8	-.7	-14.9	18	4	15	0	1	2	.0	.0	.0	.0
LANDING GEAR UP	-	486.0	1308.0	1.1	-.7	732	445	453	-5	3	-6	.0	.0	.0	.0
LANDING GEAR DOWN	+	486.0	1304.5	1.3	-.8	1958	1052	1060	-9	5	-7	.0	.0	.0	.0
2 CREW+EQUIP, CM-LM	+	485.0	1170.7	35.3	-19.5	59	47	17	0	2	17	.0	.0	.0	.0
LM EQUIP.RELOC.1	-	24.0	1154.5	46.6	-24.5	0	0	0	0	0	0	.0	.0	.0	.0
LM EQUIP.RELOC.1	+	24.0	1145.7	.6	.8	3	1	2	0	0	0	.0	.0	.0	.0
FJULP.XFR, LM-CM 1	-	1.1	1122.7	.0	-.0	0	0	0	0	0	0	.0	.0	.0	.0
CSM/LM AT SEPARATION		74757.1	1087.7	1.9	1.9	48808	434878	440350	-7859	-1272	-1190	198.7	.7	.2	.2

3.2-5

SMA-8-D-027(III) REV 3

U
N
I
T
E
D
S
T
A
T
E
S
O
F
A
M
E
R
I
C
A

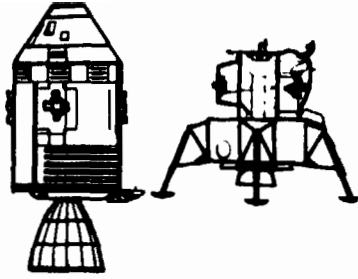

XA COORDINATES TABLE 3.2-2 (CONTINUED)
CSM 113/LM-11 EXPECTED SEQUENTIAL MASS PROPERTIES

DESCRIPTION	S	WEIGHT POUNDS	C. G. INCHES			INERTIAS SLUG-FT ²			PRODUCTS SLUG-FT ²			DISPERSIONS LB/IN			
			X	Y	Z	I _{XX}	I _{YY}	I _{ZZ}	P _{XY}	P _{XZ}	P _{YZ}	DW	DX	DY	DZ
CSM PRE CIRC. BURN		38056.4	943.7	3.9	3.1	21449	60247	64630	-2406	1379	-666	193.6	.7	.3	.3
CSM POST CIRC. BURN		37778.5	944.0	3.8	3.2	21310	60200	64450	-2393	1376	-683	193.6	.7	.3	.3
DEPLOY M.S. AND G.R.		37778.5	944.0	4.3	2.8	23344	61058	65626	-2703	1607	-1553	193.6	.7	.3	.3
CSM PRE PLANE CHANGE 1		37538.5	944.1	3.9	3.1	21130	60063	64347	-2410	1398	-626	193.6	.7	.3	.3
CSM POST PLANE CHANGE 1		36404.7	945.1	3.7	3.2	20565	59795	63536	-2346	1384	-697	193.6	.7	.3	.3
DEPLOY M.S. AND G.R.		36404.7	945.1	4.2	2.8	22600	60652	64713	-2661	1618	-1568	193.6	.7	.3	.3
CSM AT ASCT. STAGE DOCKING		36312.1	945.2	3.7	3.2	20466	59735	63487	-2343	1391	-672	193.6	.8	.3	.3
ASCENT STAGE AT DOCKING		5744.8	1165.3	4.6	-2.5	3265	2269	2665	-109	-14	-385	27.2	.8	.6	.2
CSM/ASCENT STAGE MANNED		42056.9	975.2	3.8	2.4	23767	113896	118009	-2238	30	-1063	195.5	.8	.3	.3

3.2-6

SNA-8-D-027(III) REV 3

H
U
N
I
T
E
D
S
T
A
T
E
S
O
F
A
S
T
R
I
A
N
A
U
T
I
C
A
S
T
R
O
N
A
U
T
I
C
S

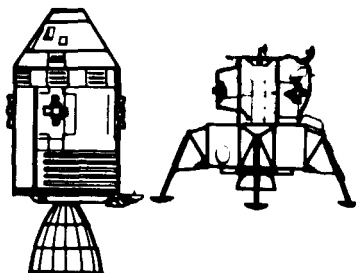

XA COORDINATES

TABLE 3.2-2 (CONTINUED)
CSM 113/LM-11 EXPECTED SEQUENTIAL MASS PROPERTIES

Amendment 114
9/15/71

DESCRIPTION	S	WEIGHT POUNDS	C. G. INCHES			INERTIAS SLUG-FT ²			PRODUCTS SLUG-FT ²			DISPERSIONS LB/IN			
			X	Y	Z	I _{XX}	I _{YY}	I _{ZZ}	P _{XY}	P _{XZ}	P _{YZ}	D _W	D _X	D _Y	D _Z
2 CREW+EQUIP.LM-CM	-	817.0	1171.5	23.1	-16.4	163	106	131	28	-12	7	.0	.0	.0	.0
EQUIP.XFR. CM-LM	+	351.4	1188.1	21.6	-15.4	58	46	57	23	-18	-10	.0	.0	.0	.0
LM EQUIP.RELOC.3	-	21.4	1122.7	.0	-.0	0	0	0	0	0	0	.0	.0	.0	.0
LM EQUIP.RELOC.3	+	21.4	1204.2	31.4	-40.8	0	0	0	0	0	0	.0	.0	.0	.0
2 CREW+EQUIP.LM-CM	+	817.0	1033.3	8.3	-2.3	106	86	74	8	-12	-8	.0	.0	.0	.0
EQUIP.XFR. CM-LM	-	351.4	1072.5	2.8	11.6	25	165	150	-11	-39	0	.0	.0	.0	.0
CSM/ASCENT STAGE UNMANNED		42036.9	973.5	3.7	2.4	23672	110268	114367	-2517	257	-1061	195.5	.8	.3	.3
CM EQUIP.RELOC.3	-	199.1	1039.7	-1.7	-12.8	22	8	20	1	0	1	.0	.0	.0	.0
CM EQUIP.RELOC.3	+	199.1	1019.7	4.1	-22.8	31	26	18	-2	4	-10	.0	.0	.0	.0
CSM PJST ASCENT STAGE JET		36777.7	945.8	3.8	2.9	20575	59682	63403	-2224	1239	-700	193.6	.7	.3	.3
DEPLOY M.S. AND G.R.		36777.7	945.8	4.3	2.5	22607	60538	64579	-2541	1475	-1569	193.6	.7	.3	.3
CSM PRE ORBIT SHAPING		36622.6	945.9	3.9	2.9	20467	59595	63336	-2232	1256	-664	193.6	.7	.3	.3
CSM POST ORBIT SHAPING		36378.7	946.2	3.8	2.9	20345	59515	63140	-2216	1253	-679	193.6	.8	.3	.3
EXPERIMENT JETT SM	-	78.5	886.0	22.0	-50.3	0	0	0	0	0	0	.0	.0	.0	.0
CSM AT SATT. JETT.		36300.2	946.3	3.8	3.0	20292	59406	63073	-2198	1199	-662	193.6	.8	.3	.3

3.2-7

SMA-8-D-027(III) REV 3

W
H
I
T
E
A
S
P
A
C
E
S
H
I
P
C
O
R
P
O
R
A
T
I
O
N

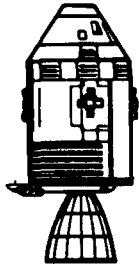

XA COORDINATES TABLE 3.2-2 (CONTINUED)
CSM 113/LM-11 EXPECTED SEQUENTIAL MASS PROPERTIES

Amendment 114
9/15/71

DESCRIPTION	S	WEIGHT POUNDS	C. G. INCHES			INERTIAS SLUG-FT ²			PRODUCTS SLUG-FT ²			DISPERSIONS LB/IN			
			X	Y	Z	IXX	IYY	IZZ	PXY	PXZ	PYZ	DW	DX	DY	DZ
CM EQUIP.RELOC.4	-	172.8	1019.1	4.1	-23.6	24	21	15	-2	5	-9	.0	.0	.0	.0
CM EQUIP.RELOC.4	+	172.8	1042.0	-.9	-14.9	18	4	15	0	1	2	.0	.0	.0	.0
CSM PRE EVA		26892.1	970.9	1.2	3.6	15529	45647	44829	-795	916	-1217	193.6	1.2	.4	.4
EQUIP.XFR. SM-CM	-	94.3	899.9	52.7	-50.0	0	14	14	0	-1	0	.0	.0	.0	.0
EQUIP.XFR. SM-CM	+	94.3	1020.2	-23.2	15.3	3	9	5	0	4	0	.0	.0	.0	.0
EVA OFFLOAD	-	32.6	1047.8	-26.7	37.3	0	0	0	0	0	0	.0	.0	.0	.0
CSM PJST EVA		26859.5	971.2	1.0	3.8	15421	45483	44677	-731	837	-1160	193.6	1.2	.4	.4
CM EQUIP.RELOC.5	-	256.8	1033.0	-2.1	-14.8	30	21	28	1	0	0	.0	.0	.0	.0
CM EQUIP.RELOC.5	+	256.8	1020.7	6.3	-7.0	12	10	14	0	-1	-2	.0	.0	.0	.0
CSM W/PGA STOWED		26859.5	971.1	1.1	3.8	15391	45383	44588	-707	871	-1170	193.6	1.2	.4	.4
DEPLOY M.S. AND G.R.		26859.5	971.1	1.7	3.3	17449	46244	45785	-1123	1180	-2050	193.6	1.2	.4	.4
CSM PRE CM/SM SEPARATION		26606.7	971.5	1.1	3.8	15203	45150	44390	-724	899	-1112	193.6	1.2	.4	.4
SM POST CM/SM SEPARATION		13620.8	907.1	2.1	1.9	9283	14916	14727	-388	540	-1084	192.0	1.4	.7	.7

3.2-9

SMA-8-D-027(III) REV 3

TABLE 3.2-3 (CONTINUED)
LM-11 CONTINGENCY MASS PROPERTIES

To Be Supplied.

3.2-14

SNA-8-D-027(III)REV 3

M M M E E E L E E E M H H M E L L

TABLE 3.2-3.1

**LRV MASS PROPERTIES
FIRST TRAVERSE DEPARTURE**

To Be Supplied.

M M U U E E M M L L E E U U L L U U H H L L E L L E

TABLE 3.2-3.1 (CONTINUED)

LRV MASS PROPERTIES

FIRST TRAVERSE RETURN

To Be Supplied.

U U U U E E L L E E E E U U U U E E L L E

TABLE 3.2-3.1 (CONTINUED)

LRV MASS PROPERTIES
SECOND TRAVERSE DEPARTURE

To Be Supplied.

TABLE 3.2-3.1 (CONTINUED)

LRV MASS PROPERTIES
SECOND TRAVERSE RETURN

To Be Supplied.

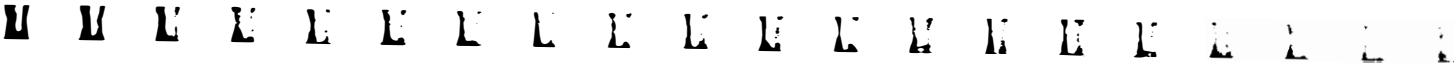

TABLE 3.2-3.1 (CONTINUED)

LRV MASS PROPERTIES
THIRD TRAVERSE DEPARTURE

To Be Supplied.

M U E E E L E L E L M H H E E L E

TABLE 3.2-3.1 (CONTINUED)

LRV MASS PROPERTIES
THIRD TRAVERSE RETURN

To Be Supplied.



TABLE 3.2-4

HIGH ALTITUDE MASS PROPERTIES

To be supplied at a later date.

U U U E E E E E E E E E E E E E E E

TABLE 3.2-5

PAD ABORT MASS PROPERTIES

To be supplied at a later date.

M M L L E E L L E L E L M M M M A A L E

TABLE 3.2-6

SIVB MASS PROPERTIES

M M E

TABLE 3.2-7

CSM 113 CONSUMABLES WEIGHT CHANGE SUMMARY
(To be used in conjunction with CSM sequential mass
properties Table 3.2-2).

From	EVENT	To	Consumable	Weight Change (Pounds)	Amount Remaining (Pounds)	Total Usage (Pounds)		
Earth Orbit		Pre Trans/Dock	SM-Hydrogen					
			Tank 1 & 2	-1.6	53.6	-1.6		
			Tank 3	-0.6	27.0	-0.6		
			SM-Oxygen					
			Tank 1 & 2	-7.5	625.7	-7.5		
			Tank 3	-0.7	315.9	-0.7		
			CM-Waste H ₂ O	+4.8	39.8			
			CM-Potable H ₂ O	+6.0	36.0			
			Pre Trans/Dock	Post Trans/Dock	SM-RCS	-70.6	1,271.8	-70.6
			Post Trans/Dock		Pre L.O.I.	SM-Hydrogen		
Tank 1 & 2	-4.7	48.9				-6.3		
Tank 3	-9.3	17.7				-9.9		
SM-Oxygen								
Tank 1 & 2	-61.4	564.3				-68.9		
Tank 3	-81.5	234.4				-82.2		
SM-RCS	-110.2	1,161.6				-180.8		
CM-Waste H ₂ O	+4.2	44.0						
CM-LiOH	+24.0	24.0						
CM-Food	-6.2					-6.2		
Fecal	+2.0	2.0						
Pre L.O.I.	Post L.O.I.	SM-SPS	-26,300.2	14,293.5	-26,300.2			
Post L.O.I.		Pre D.O.I.	SM-Hydrogen					
			Tank 1 & 2	-0.8	48.1	-7.1		
			Tank 3	-0.1	17.6	-10.0		
			SM-Oxygen					
			Tank 1 & 2	-6.8	557.5	-75.7		
			Tank 3	-1.3	233.1	-83.5		
			SM-RCS	-41.9	1,119.7	-222.7		



TABLE 3.2-7 (CONTINUED)

CSM 113 CONSUMABLES WEIGHT CHANGE SUMMARY
(To be used in conjunction with CSM sequential mass
properties Table 3.2-2).

From	EVENT	To	Consumable	Weight Change (Pounds)	Amount Remaining (Pounds)	Total Usage (Pounds)
Pre D.O.I.		Post D.O.I.	SM-SPS	-1,561.4	12,732.1	-27,861.6
Post D.O.I.		CSM/LM Sep.	SM-Hydrogen			
			Tank 1 & 2	-4.0	44.1	-11.1
			Tank 3	-0.8	16.8	-10.8
			SM-Oxygen			
			Tank 1 & 2	-22.9	534.6	-98.6
			Tank 3	-13.5	219.6	-97.0
			SM-RCS	-114.7	1,005.0	-337.4
			CM-LiOH	+6.0	30.0	
			CM-Food	-3.8		-10.0
			Fecal	+3.0	5.0	
CSM/LM Sep.		Pre Circular- ization	SM-Hydrogen			
			Tank 1 & 2	-0.1	44.0	-11.2
			Tank 3	-0.1	16.7	-10.9
			SM-Oxygen			
			Tank 1 & 2	-0.7	533.9	-99.3
			Tank 3	-2.3	217.3	-99.3
			SM-RCS	-23.7	981.3	-361.1
Pre Circular- ization		Post Circular- ization	SM-SPS	-277.9	12,454.2	-28,139.5
Post Circular- ization		Pre Plane Change	SM-Hydrogen			
			Tank 1 & 2	-11.5	32.5	-22.7
			Tank 3	-2.5	14.2	-13.4
			SM-Oxygen			
			Tank 1 & 2	-83.6	450.3	-182.9
			Tank 3	-33.4	183.9	-132.7
			SM-RCS	-112.0	869.3	-473.1
			Fecal	+3.0	8.0	



TABLE 3.2-7 (CONTINUED)

CSM 113 CONSUMABLES WEIGHT CHANGE SUMMARY
(To be used in conjunction with CSM sequential mass
properties Table 3.2-2).

From	EVENT	To	Consumable	Weight Change (Pounds)	Amount Remaining (Pounds)	Total Usage (Pounds)
Pre Plane Change		Post Plane Change	SM-SPS	-1,133.8	11,320.4	-29,273.3
Post Plane Change		CSM/ASCT Dock	SM-Hydrogen			
			Tank 1 & 2	-1.4	31.1	-24.1
			Tank 3	-0.3	13.9	-13.7
			SM-Oxygen			
			Tank 1 & 2	-10.6	439.7	-193.5
			Tank 3	-4.0	179.9	-136.7
			SM-RCS	-87.1	782.2	-560.2
			CM-Food	-4.3		-14.3
			CM-LIOH	+12.0	42.0	
			CM-Fecal	+3.1	11.1	
CSM/ASCT Dock		Pre Orbit Shaping	SM-Hydrogen			
			Tank 1 & 2	-8.4	22.7	-32.5
			Tank 3	-1.9	12.0	-15.6
			SM-Oxygen			
			Tank 1 & 2	-60.5	379.2	-254.0
			Tank 3	-33.0	146.9	-169.7
			SM-RCS	-55.5	726.7	-615.7
			CM-LIOH	+5.0	47.0	
			CM-Fecal	+3.0	14.1	
			CM-Food	-3.8		-18.1
Pre Orbit Shaping		Post Orbit Shaping	SM-SPS	-243.9	11,076.5	-29,517.2
Post Orbit Shap- ing		Pre T. E. I.	SM-Hydrogen			
			Tank 1 & 2	-0.4	22.3	-32.9
			Tank 3	-0.1	11.9	-15.7
			SM-Oxygen			
			Tank 1 & 2	-2.8	376.4	-256.8
			Tank 3	-1.7	145.2	-171.4
			SM-RCS	-36.3	690.4	-652.0

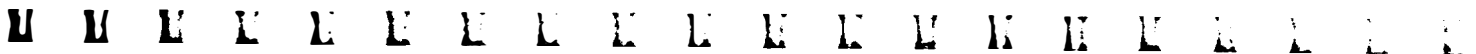

TABLE 3.2-7 (CONCLUDED)

CSM 113 CONSUMABLES WEIGHT CHANGE SUMMARY
(To be used in conjunction with CSM sequential mass
properties Table 3.2-2).

From	EVENT	To	Consumable	Weight Change (Pounds)	Amount Remaining (Pounds)	Total Usage (Pounds)
Pre T.E.I.		Post T.E.I.	SM-SPS	-9,366.8	1,709.7	-38,884.0
Post T.E.I.		SM Jettison	SM-Hydrogen			
			Tank 1 & 2	-10.3	12.0	-43.2
			Tank 3	-2.9	9.0	-18.6
			SM-Oxygen			
			Tank 1 & 2	-82.9	293.5	-339.7
			Tank 3	-49.2	96.0	-220.6
			SM-RCS	-117.8	572.6	-769.8
			CM-LiOH	+13.0	60.0	
			CM-Food	-7.3		-25.4
			CM-Fecal	+4.6	18.7	
SM Jettison		CM @ Entry	CM-RCS	-11.6	233.4	-11.6
CM @ Entry		CM @ M.C. Deploy	CM-RCS	-30.7	202.7	-42.3
CM @ M.C. Deploy		CM @ Impact	CM-RCS	-202.7	0.0	-245.0



TABLE 3.2-8

LM-11 CONSUMABLES CHANGE SUMMARY

(To be used in conjunction with the LM sequential mass properties Table 3.2-3)

From	EVENT To	Consumable	Weight Change (Pounds)	Amount Remaining (Pounds)	Total Usage (Pounds)
Earth Orbit	CSM/LM Separation	D/S-Oxygen	-1.0	92.8	-1.0
		D/S-Water	-12.0	376.0	-12.0
		LM-RCS	-5.0	600.4	-5.0
CSM/LM Separation	Pre P.D.I.	D/S-Oxygen	-0.6	92.2	-1.6
		D/S-Water	-23.0	353.0	-35.0
		LM-RCS	-50.7	549.7	-55.7
Pre P.D.I.	LM @ Touchdown	D/S-Oxygen	-0.1	92.1	-1.7
		D/S-Water	-2.0	351.0	-37.0
		LM-RCS	-90.0	459.7	-145.7
		LM-DPS	-18,790.5	695.1	-18,790.5
LM @ Touchdown	A/S @ Lift-Off	LM-RCS	-5.0	454.7	-150.7
A/S @ Lift-Off	A/S in Orbit	LM-APS	-4,942.7	283.0	4,942.7
A/S in Orbit	A/S Pre T.P.I.	A/S-Water	-8.0	77.0	-8.0
		A/S-Oxygen	-0.2	4.6	-0.2
		LM-RCS	-44.6	410.1	-195.3
A/S Pre T.P.I.	A/S Post T.P.I.	LM-APS	-35.4	247.6	4,978.1
A/S Post T.P.I.	A/S @ Docking	A/S-Water	-7.0	70.0	-15.0
		A/S-Oxygen	-0.3	4.3	-0.5
		LM-RCS	-70.3	339.8	-265.6
A/S @ Docking	A/S Jettison	A/S-Water	-20.0	50.0	-35.0

U U U E U E U E U E U E U U U U U U

TABLE 3.2-9
MISSION J-2 COMMAND MODULE STOWAGE VOLUME CENTROID

Amendment 114
9/15/71

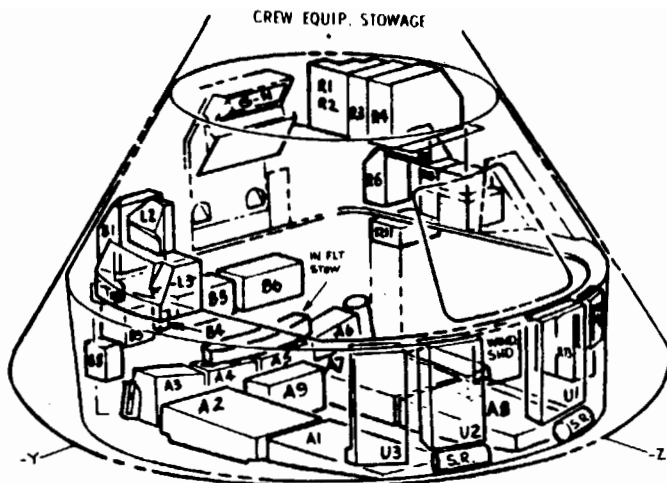

"J-SERIES" LAUNCH STOWAGE LIST

3.2-29

SNA-8-D-027(III) REV 3

- A-1**
TV CAMERA, COLOR
ZOOM LENS WITH COVER
TV MONITOR
TV MONITOR CABLE
TV POWER CABLE
TV CAMERA HIGHLIGHT
TV MOUNTING BRACKET
16MM CAMERA SEXTANT ADAPTER
70MM CAMERA ADAPTER
70MM REMOTE CONTROL CABLE
16MM FILM MAGS AND 2 BAGS-7
70MM FILM MAGAZINES AND BAG -2
2 SPEED INTERVAL TIMER
VOICE RECORDER W/ CASS. & BATT
UV FILTER ASSY (105MM LENS)
UV CAMERA MOUNT
UV 70MM MAGAZINE
INFLIGHT RETAINER STRAPS -3
CM TOWELS (RED, WHITE, BLUE) -9
- A-2**
PPK'S -3
TISSUE DISPENSERS -8
FECAL CONTAINMENT SUBSYSTEM -3
HEAD REST PADS -3
HEEL CLIPS -3 PR
HEEL RESTRAINT CONTAINER
JETTISON STOWAGE BAGS -3 (2 OFF *)
- EVA GLOVES (CMI)**
EVA EQUIPMENT CONTAINER
PCA ADAPTER
WRIST TETHER
IV CREWMAN TETHER
OPS PCA STRAPS -4
OPS CONTROL VALVE STRAPS -2
ENTRY TIE-DOWN ROPES AND BAG -5
ENTRY BOOTS CONTAINER
GAUGE ASSY (PANEL 603)
70MM HASSELB. HANDLE TRIGGER
VACUUM CLEANER DECOM. BAG
VACUUM CLEAN BAGS -2
VACUUM CLEAN POWD. TUB

- TOP OF A-2**
DECONTAMINATION BAGS*
ISA DECONTAMINATION BAG
CONTINGENCY LUNAR SAMPLE RETURN
LS HASSELBLAD MAGS -4
SRC NO. 1 AND NO. 2
LUNAR SAMPLE (B/SLS5 AREA)
16MM DAC MAGS -3
PENETROMETER
40 LB SAMPLE -2
- A-3**
CO2 ABSORBERS -4
FIRE EXTINGUISHER (ON A-3)
- A-4**
CO2 ABSORBERS -4
- A-5**
CO2 ABSORBERS -4
- A-6**
CO2 ABSORBERS -4
SIDE A-6
VACUUM CLEANER
- A-7**
FOOD, PACKAGED
FECAL COLLECTION ASSY -30 (12*)
FECAL COLLECTION ASSY. BAGS -2 (11*)
- SIDE OF A-7**
INFLT RETINER STRAP
EVA UMBILICAL & BAG

- A-8**
IN-FLIGHT EXERCISER
CNG -9
EMU MAINTENANCE KIT
LIGHT WEIGHT HEADSETS -3
CNG ELECTRICAL ADAPTERS -4
CNG ELECTRICAL ADAPTERS BAG
RELIEF RECEPTACLE ASSY
RELIEF RECEPTACLE RESTRAIN. STRAP
RELIEF RECP. CONTAINER
O2 GAS FILTER ASSY. -3
TOOL SET ASSEMBLY
PLY DUCTS -3
PLY CONTAINER
70MM FILM MAGAZINES AND BAG -3
70 MM MAG. AND TRANS. BAG -3*
H2 GAS SEPARATOR
H2 GAS SEPARATOR BAG
PCA O2 UMBILICAL INTERCONN. -3 (11*)
O2 INTERCONNECT CONTAINER
SNAG LINE
SNAG LINE CONTAINER
INFLIGHT RETAINER STRAP
WATER PANEL COUPLING ASSY.
WHS WATER PANEL QD
WHS POWER CABLE
WHS QD PRESSURE CAP
WHS B. U CONTAINER
QD ECS CONTAINER
TAPE CASSETTE KIT
ACOUSTIC TONE BOOSTER
ACOUSTIC TONE BOOSTER BAG
16MM FILM MAGS AND BAG -4
35 MM CAMERA ADAPTER & BAG
URINE FILTER ASSY AND BAG -3
TAPE RECORDER BATTERIES -11
TAPE RECORDER BATTERIES BAG (PPK)
16MM CAMERA BRACKET & BAG
SIDE OF A-8
BAG - HOSE, URINE, VACUUM ETC.*
VACUUM BRUSH
URINE HOSE ASSY
EVA GUARDS (LEFT, CENTER, RIGHT)
UTILITY STRAP
UNIPOD POLE

- A-9**
CO2 ABSORBERS -4
CARRIER ASSY. CONTAINER
- B-1**
FOOD AND HYGIE NE ITEMS
- B-2**
35MM CAMERA AND MAG
35MM FILM CASS. -3
35MM CAMERA GADGET BAG
- B-3**
70MM HASSELBLAD CAMERA AND MAG.
16MM CAMERA AND MAG.
75MM LENS
18MM LENS
10MM LENS WITH COVER
POWER CABLE, DAC
RIGHT ANGLE MIRROR
INFLIGHT RETAINER STRAP
1" AUTO SPOTMETER
- B-5**
CO2 ABSORBERS -4
CLOSEOUT CURTAIN
DATA RETENTION SNAPS (SHORT) -6
DATA RETENTION SNAPS (LONG) -6
TEMP. STOWAGE POUCHES -2
- B-6**
CO2 ABSORBERS -4
CLOSEOUT CURTAIN
DATA RETENTION HOOKS (SHORT) -2
DATA RETENTION HOOKS (LONG) -2
SNAP CLAMPS -8
SPRING CLIPS -8
- B-8**
CHLOR. BUFFER AMPULES -16
CHLOR. AMPULES -16
CHLOR. AMPULES CONTAINERS -2
- L-2**
CCU CONTROL HEAD CONTAINER
CCU CONTROL HEAD
GROUNDING CABLE
CCU CABLE (SPARE)
CCU CABLE STRAP
TOOL HANDLE ADAPTER
INFLIGHT RETAINER STRAPS -2
70MM INTERVAL METER CABLE (PCM)
16MM DAC TIMING CABLE (PCM)
DOCKING PROBE CABLE
- L-3**
FOOD, PACKAGED
CONTINGENCY FEEDING VALVE
- R-1**
CONTINGENCY CHECKLIST
ENTRY CHECKLIST
SYSTEMS CHECKLIST
SYSTEMS UPDATE
G&C CHECKLIST
- R-2**
LAUNCH CHECKLIST
CSM UPDATES
CSM LM ORBIT MONITOR CHARTS

- R-3**
RESCUE BOOK
EARTH ORBITAL MAP
DATA CARD KIT
EYEPATCH
METER COVERS -2
VEEB MOUNTS, G AND H PANEL
FUSE (16MM CAMERA)
FLIGHT DATA FILE CLIPS -6
LM XFR DATA CARD KIT
LM DATA CARD BOOK
LM LUNAR SURFACE CHECKLIST
LM ACTIVATION CHECKLIST
LM TIMELINE BOOK
LM ORBIT CHARTS (A,B,C,D)
- R-12**
CSM LUNAR LANDMARK MAP
CSM SYSTEM DATA
CSM MALFUNCTION PROCEDURES
FLIGHT PLAN
CMP SOLO BOOK

- R-4**
RUCKSACK SURVIVAL KIT NO. 1
RUCKSACK SURVIVAL KIT NO. 2

- R-5**
PROBE STOWAGE STRAPS -2
INFLIGHT RETAINER STRAPS -7 (3*)
UTILITY STRAPS -6 (3*)
URINE FILTER BAG
COUCH RESTRAINING STRAPS -2

- R-6**
TAPE
DIA HIGH DENSITY SUNFILTERS -2
CHLOR. SYRINGE KNOB
CHLOR. SYRINGE CASING
CHLOR. NEEDLE
CHLOR. SYRINGE CONTAINER
PENLIGHTS AND CONTAINER -5

- R-8**
MEDICAL KIT

- R-11**
URINE TRANSFER SYSTEMS -3
URINE RECEIVER ASSY. (SPARE)
ROLL ON CUFFS (RED, WHITE, BLUE)
URINE FILTER, HICAP. & BAG

- R-13**
16MM MAGAZINES AND TRANS. BAG -6*
16 MM MAG. AND TRANS. BAG -2*
70 MM MAGAZINES AND TRANS. BAG -4*
70 MM MAG. AND TRANS. BAG -3*
RADIATION DOSIMETER
70 MM MAG. AND TRANS. BAG -3*
16 MM MAG. AND TRANS. BAG -2*

- AFT. BLKHD.**
EVA UMBILICAL ASSY.
EVA TETHER CONTAINER

- U-1**
LIQUID COOLED GARMENTS -2
TEMPORARY STOWAGE CONTAINERS -3
H27 RADIATION DOSIMETER
- U-2**
INFLIGHT HELMET STOWAGE BAGS -3
ACCESSORY BAGS -3
ICG JACKETS -3
ICG TROUSERS -3
ICG BOOTS (RIGHT) -3
ICG BOOTS (LEFT) -3
EARTUBES -3
CABIN FAN FILTER AND BAG

- U-3**
COAS FILTER
COAS LIGHT BULBS -2
16MM CAMERA BRACKET
LM DOCKING TARGET
DOCKING TARGET ADAPTER

- U-4**
TAPE RECORDER CASSETTES -4
TAPE RECORDER BATTERIES -4
10 X 40 MONOCULAR
INTERVAL METER (70MM HASSELBLAD
250MM LENS

- PCA BAG**
HELMET PROTECTIVE SHIELD
ELECTRICAL CONNECTOR COVERS -3
UCTA CLAMPS -3
WATER BAGS, CONTING. RETURN -15
H2O/URINE BAGS, CONTINGENCY -2
FECAL MANAGEMENT BAG

- PGA**
O2 HOSE SCREEN CAPS -3
EAR PLUGS -2 PR

- ECU**
CO2 ABSORBERS -2

- LMFEB**
CCU CABLE (LEFT, CENTER, RIGHT)
WATER GUN

- LMHLB**
O2 UMBILICAL (L, CENTER, R)
O2 HOSE CLAMPS -3
ASSY. L CALFAF ADAPTER

- UEB**
RENDEZVOUS SHADE (LEFT, RIGHT)
SIDE SHADE (LEFT, RIGHT)
MATCH SHADE
WINDOW SHADE CONTAINER
RH RENDEZVOUS SHADE (S-17B EXP.)
UV WINDOW SHADE

- AFT. UEB**
SLEEP RESTRAINTS (L, CENTER, R)
O2 MASK AND HOSE -3
O2 MASK AND HOSE CONTAINER
INFLIGHT RETAINER STRAPS -3

TABLE 3.2-9 (CONTINUED)
MISSION J-2 COMMAND MODULE STOWAGE VOLUME CENTROID

Amendment 114
9/15/71

LAUNCH STOWAGE	ITEM	RETURN STOWAGE
LM	40 LB SAMPLE	Top of A-1
LM	PPK'S - 3	A-8
LM	CONTINGENCY LUNAR SAMPLE	On Top of A-2 in ISA
LM	OXYGEN PURGE SYSTEM	A-7
LM	EMU MAINTENANCE KIT	In CDR Helmet Stowage Bag in PGA Bag
LM	PURGE VALVE ASSY	A-7
LM	STANDARD FLAG KIT	A-8
LM	CONTINGENCY IV SAFETY TETHER	A-7
LM	SR C NO. 1	B-5
LM	2	B-6
LM	SOLAR WIND COMPOSITION	On Top Of A-2 in ISA
LM	IV CREWMAN TETHERS - 2	A-7
LM	ISA	Inside ISA Decon. Bag on Top of A-2
LM	SAMPLE RETURN BAG (B/SLSS AREA - 36 lb)	Inside Sample Return Decon. Bag on Top of A-7
LM	PENETROMETER DRUM	A-7
LM	40LB SAMPLE	A-9
LM	40LB SAMPLE	Between A-9 & PGA Bag
A-2	603 GAUGE ASSY	A-7
A-2	SAMPLE RETURN DECON. BAG (B/SLSS AREA)	ON TOP OF A-7
TOP A-2	PENETROMETER DECONT BAG	A-7
A-2	VACUUM CLEANER BAGS-2	A-7
A-2	VACUUM CLEANER POWER CABLE	A-7
A-2	VACUUM CLEANER DECON. BAG	A-7
A-2	HEAD REST PADS - 3	On Couch
A-2	HEEL CLIPS - 3 PR.	On Crew
A-2	OPS CONTROL UNIT ADAPTER	A-7
A-2	OPS ATTACH. STRAPS - 4	A-7
A-2	EVA EQUIPMENT CONTAINER	A-7
A-7	FECAL COLLECTION ASSY. - 30	12 - Offloaded Unused A-7
A-8	OWG ELECTRICAL ADAPTERS - 4	3 - On Crew 1 - A-8
SM SIM BAY	24" PAN CAMERA MAGAZINE	A-2
SM SIM BAY	3" MAPPING CAMERA MAGAZINE	B-1

LAUNCH STOWAGE	ITEM	RETURN STOWAGE
B-5	CONTAINERS	Offloaded TO LM
B-6	CONTAINERS	Offloaded TO LM
A-9	CO ₂ ABSORBERS - 4	A-9 Offloaded Inside Container
B-5	CO ₂ ABSORBERS - 4	B-5 Offloaded Inside Container
B-6	CO ₂ ABSORBERS - 4	B-6 Offloaded Inside Container
TOP A-2	SRC DECON. BAGS - 2	1 - B-5 1 - B-6
U-2	ICG JACKETS - 3	On Crew
U-2	ICG TROUSERS - 3	On Crew
U-2	ICG BOOTS (RIGHT) - 3	On Crew
U-2	ICG BOOTS (LEFT) - 3	On Crew
	<u>PGA EQUIPMENT</u>	
ON CREW	PRESSURE HELMETS - 3	2 - In PGA Bag 1 - On PGA, Sleep Restraint on Top A-7 and A-8
ON CREW	PRESSURE GARMENT ASSEMBLY (PGA) - 3	2 - In PGA Bag 1 - In Sleep Restraint on Top A-7 and A-8
LM	LEVA'S - 2	2 - On Helmet in PGA Bag
A-2	EV GLOVES (CMP)	In Helmet in Accessory Bag On Top of A-7 & A-8
LM	EV GLOVES - 2 PR.	In Helmet in Accessory Bags in PGA Bag
ON CREW	IV GLOVES - 3 PR.	2 - In PGA's in PGA Bag 1 - In PGA in Sleep Restraint on Top of A-7 and A-8
U-2	ACCESSORY BAGS - 3	2 - In Helmets in PGA Bag 1 - In Helmet on Top of A-7 and A-8
LM	HELMET STOWAGE BAGS - 2	2 - On Helmet in PGA Bag
PGA BAG	HELMET PROTECTIVE SHIELD	On Helmet (Without LEVA) Top of A-7 and A-8

3.2-30

SNA-8-D-027(III) REV 3

TABLE 3.2-9 (CONTINUED)
MISSION J-2 COMMAND MODULE STOWAGE VOLUME CENTROIDS
SPACECRAFT 113

<u>AREA</u>	<u>X</u>	<u>Y</u>	<u>Z</u>
A1	1011.0	-21.0	-22.0
2	1011.0	-22.0	8.0
A2 ISA	1019.0	-22.0	8.0
3	1016.0	-24.0	28.0
4	1015.0	-7.0	28.0
5	1015.0	9.0	28.0
6	1017.0	26.0	28.0
7	1011.0	22.0	8.0
8	1011.0	21.0	-23.0
9	1013.0	0.0	16.0
Top of A1	1017.0	-21.0	-22.0
Top of A2	1019.0	-22.0	8.0
Top of A7	1019.0	22.0	8.0
Top of A8	1020.0	25.0	-8.0
Top of A9	1016.0	0.0	16.0
Between PGA & A9	1014.0	0.0	8.0
B1	1050.0	-27.0	39.0
2	1039.0	-38.0	37.0
3	1031.0	-28.0	40.0
4	1031.0	-20.0	40.0
5	1031.0	-8.0	39.0
6	1031.0	13.0	39.0
8	1024.0	-38.0	37.0
L2	1059.0	-44.0	14.0
3	1048.0	-47.0	12.0
R1	1072.0	26.0	21.0
2	1072.0	26.0	14.0
3	1072.0	26.0	9.0
4	1075.0	28.0	3.0
5	1059.0	44.0	15.0
6	1048.0	46.0	29.0
8	1052.0	46.0	12.0
11	1038.0	47.0	26.0
13	1024.0	45.0	-26.0
U1	1033.0	23.0	-50.0
2	1033.0	-23.0	-50.0
3	1033.0	-36.0	-44.0
4	1038.0	39.0	-43.0
L. H. Crew Station	1043.0	-24.5	-11.9
Ctr. Crew Station	1043.0	0.0	-11.9
R. H. Crew Station	1043.0	24.5	-11.9



TABLE 3.2-9 (CONCLUDED)

MISSION J-2 COMMAND MODULE STOWAGE VOLUME CENTROID

The following stowage locations have unique volume centroids not associated with stowage volumes.

<u>NOMENCLATURE</u>	<u>LOCATION</u>	<u>X</u>	<u>Y</u>	<u>Z</u>
G&N Signal Cond. Panel	LEB	1069.0	25.0	29.0
Display Keyboard	LEB	1060.0	26.0	32.0
Sleep Restraint Assy - Rt. & Center	Aft UEB	1018.0	23.0	-50.0
Sleep Restraint Assy - Left	Aft UEB	1018.0	-23.0	-50.0
Entry Locations				
Sleep Restraint - RH & Center	Top of Area A8	1020.0	25.0	-8.0
ITLSA - IV (CMP)	On RH & Ctr.			
	Sleep Restraint	1020.0	25.0	-22.0
Food Container	L3	1048.0	-47.0	12.0
Food Container	B1	1050.0	-27.0	39.0
Food Container	A7	1011.0	22.0	8.0
Fecal Stowage Container	RHEB	1039.0	47.0	12.0
PGA Container	On Aft Bulkhead	1015.0	0.0	-20.0
	Under Ctr. Couch			
Entry Location	Aft Bulkhead	1015.0	0.0	-6.0
Forward Hatch Container	Under LH Couch	1018.0	-24.5	-15.0
Container, R12				
(In-flight Location)	RH Girth Ring	1034.0	41.0	-21.0
Helmet Stowage & Accessory				
Bags (In-flight Location) - LH	U2	1033.0	-23.0	-50.0
Helmet Stowage and Accessory				
Bags (In-flight Location) - Ctr.	B1	1050.0	-27.0	39.0
Helmet Stowage and Accessory				
Bag (In-flight Location) - RH	L3	1048.0	-47.0	12.0
CO2 Absorbers (2)	In ECU	1031.0	-48.3	19.6
CO2 Absorbers (4)	A3	1016.0	-24.0	28.0
CO2 Absorbers (4)	A4	1015.0	-7.0	28.0
CO2 Absorbers (4)	A5	1015.0	9.0	28.0
CO2 Absorbers (4)	A6	1017.0	26.0	28.0
CO2 Absorbers (4)	A9	1013.0	0.0	16.0
CO2 Absorbers (4)	B5	1031.0	-8.0	39.0
CO2 Absorbers (4)	B6	1031.0	13.0	39.0
	Order of Locations Used in Sequential Mass Properties Tables for CO2 Absorbed			
First 8.0 lb CO2 Absorbed	B5	1031.0	-8.0	39.0
Second 16.0 lb CO2 Absorbed	(B6, A9)	1022.0	6.5	27.5
Remainder CO2 Absorbed	Composite Location	1017.4	-4.4	27.1

U U

TABLE 3.2-9.1

MISSION J-2 LUNAR MODULE STOWAGE VOLUME CENTROIDS

LM-11

<u>AREA</u>	<u>X</u>	<u>Y</u>	<u>Z</u>
A1A	280.0	-19.0	13.5
A1B	263.5	-20.6	14.9
A1C	240.5	-15.3	13.3
A1D	270.3	-15.0	19.0
A1E	265.9	-20.7	-6.0
A1F	257.4	-20.7	-6.0
A1G	257.5	-20.0	-18.0
A1H	265.9	-20.0	-18.0
A1J	273.7	-20.4	1.2
A1L	281.0	-20.0	-8.5
A1K	273.7	-20.0	-8.5
A1DA			
A1DB			
A1DC	270.3	-15.0	19.0
A1DD			
A2	260.0	-37.0	28.0
A3	280.0	0.0	-10.0
A5	221.8	-1.0	29.5
A6	278.5	-11.0	23.0
A7	250.0	11.5	31.0
A8	272.6	14.8	17.3
A9	288.0	0.0	-24.0
A10	250.0	8.0	-11.8
A11	262.4	19.8	4.2
A12	272.0	0.0	-18.0
A13	300.0	0.0	0.0
A14	239.6	-5.5	-14.8
A15	257.0	-30.0	27.5
F1A	244.5	-36.6	31.4
F1B	235.5	-35.5	38.5
F1C	242.5	-35.5	38.6
F1D	242.8	-35.4	44.7
F1E	237.9	-33.6	55.0
F1F	235.5	-37.6	46.6
F1G	228.0	-40.2	43.2
F1H	229.5	-35.5	39.0
F1J	229.5	-35.5	35.0
F1K	237.8	-37.8	31.5
F2	218.5	-22.0	43.4
F3	292.0	-21.0	38.6

U U

TABLE 3.2-9.1 (CONCLUDED)

MISSION J-2 LUNAR MODULE STOWAGE VOLUME CENTROIDS

LM-11

<u>AREA</u>	<u>X</u>	<u>Y</u>	<u>Z</u>
F4	282.2	-21.0	66.6
F5	286.0	17.8	66.6
F6A,B,C	270.3	0.0	52.8
F7A	238.0	38.0	49.8
F7B	238.4	38.6	46.0
F7C	242.8	38.0	41.0
F7D	238.0	38.0	38.4
F7E	243.2	38.0	31.2
F7F	238.0	38.0	31.6
F7G	227.9	33.0	31.8
F7H	237.7	38.3	45.5
F7J	231.5	35.4	41.8
F7K	222.6	32.3	42.7
F7L	231.8	36.0	47.3
F7M	225.7	32.3	53.4
F7N	238.0	38.0	53.1
F7P	241.0	38.0	53.4
F8	221.0	18.0	51.0
F9	219.9	-1.3	44.5
F10	221.0	-18.0	51.0

U U E

TABLE 3.2-9.2
MISSION J-2 TRANSFERABLE EQUIPMENT

Amendment 114
9/15/71

REFERENCE CODE EXPLANATION

The reference table used with this Transferable Equipment List is a directory of information sources from which data for each item were obtained. It is intended to define the exact source for each portion of the data used. This reference table is correlated to each item in the Transferable Equipment List by a 3-digit reference code number.

The code is the form

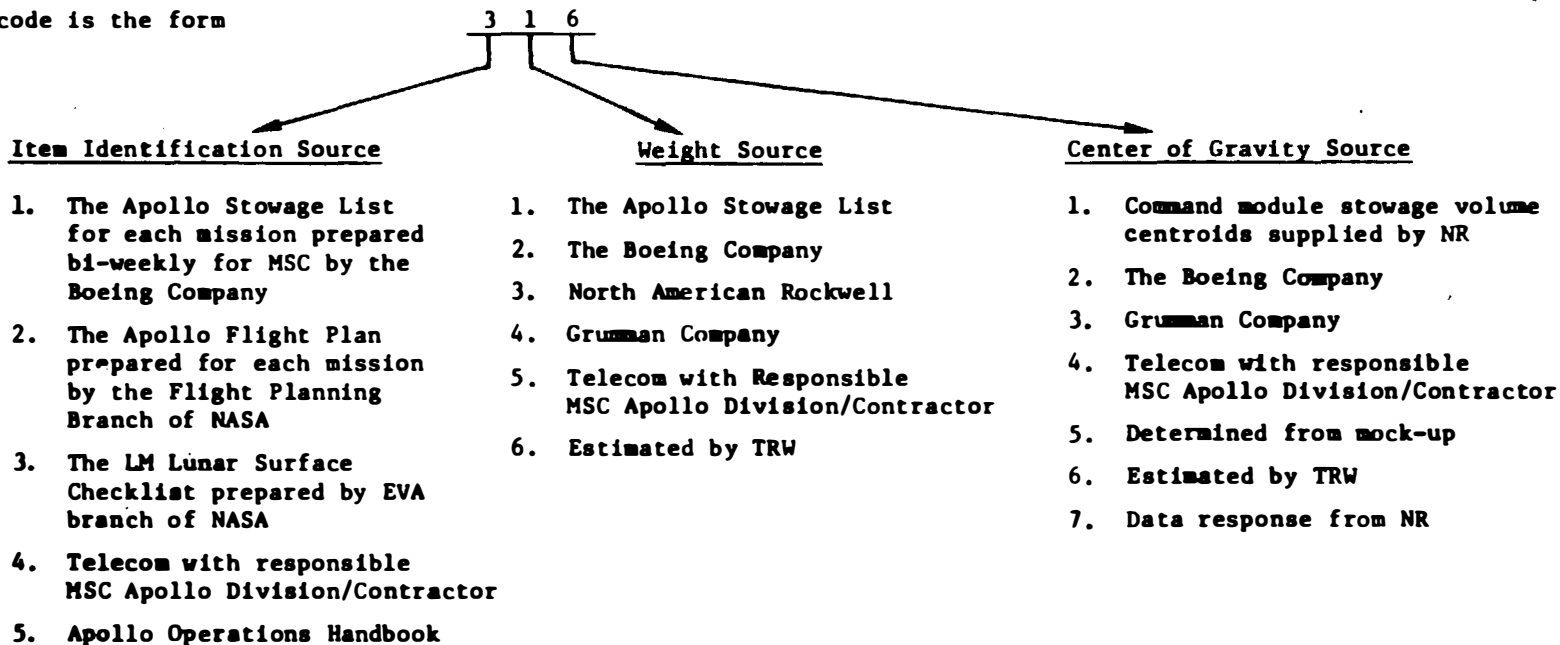

TABLE 3.2-9.2 (CONTINUED)

MISSION J-2 TRANSFERRED CREW AND EQUIPMENT STORAGE LIST								
ITEMS REARRANGED IN CH PRIOR TO FIRST MID-COURSE CORRECTION (1)								
APOLLO COORDINATES								
DESCRIPTION	STOW. ITEM	REF	NO.	STORAGE LOCATION	WEIGHT	X-C.G.	Y-C.G.	Z-C.G.
CREW-COMMAND MODULE PILOT(CMP)	N/A	227	1	JN COUCH/ICR CREW STA	139.0	1043.0	.0	-10.4
CREW-COMMANDER(CDR)	N/A	227	1	JN COUCH/ICR CREW STA	164.0	1043.0	-24.5	-10.4
BAG, MOTION SICKNESS	A0208.	111	1	JN CREW	.1	1043.0	.0	-21.0
BAG, MOTION SICKNESS	A0208.	111	1	JN CREW	.1	1043.0	.0	-21.0
BAG, MOTION SICKNESS	A0208.	111	1	JN CREW	.1	1043.0	.0	-21.0
JACKET ASSY, ICG	B0112.1	111	1	AREA U2	1.8	1033.0	-23.0	-50.0
JACKET ASSY, ICG	B0112.1	111	1	AREA U2	1.8	1033.0	-23.0	-50.0
JACKET ASSY, ICG	B0112.1	111	1	AREA U2	1.8	1033.0	-23.0	-50.0
TROUSER ASSY, ICG	B0112.2	111	1	AREA U2	1.8	1033.0	-23.0	-50.0
TROUSER ASSY, ICG	B0112.2	111	1	AREA U2	1.8	1033.0	-23.0	-50.0
TROUSER ASSY, ICG	B0112.2	111	1	AREA U2	1.8	1033.0	-23.0	-50.0
BOOT, RIGHT, ICG	B0112.3	111	1	AREA U2	.4	1033.0	-23.0	-50.0
BOOT, RIGHT, ICG	B0112.3	111	1	AREA U2	.4	1033.0	-23.0	-50.0
BOOT, RIGHT, ICG	B0112.3	111	1	AREA U2	.4	1033.0	-23.0	-50.0
BOOT, LEFT, ICG	B0112.4	111	1	AREA U2	.4	1033.0	-23.0	-50.0
BOOT, LEFT, ICG	B0112.4	111	1	AREA U2	.4	1033.0	-23.0	-50.0
BOOT, LEFT, ICG	B0112.4	111	1	AREA U2	.4	1033.0	-23.0	-50.0
HARNESS, CWG ELECTRICAL (CMP)	B0135.	111	1	IN ADAPTER BAG(A8)	.4	1011.0	21.0	-23.0
HARNESS, CWG ELECTRICAL (CDR)	B0135.	111	1	IN ADAPTER BAG(A8)	.4	1011.0	21.0	-23.0
HARNESS, CWG ELECTRICAL (LMP)	B0135.	111	1	IN ADAPTER BAG(A8)	.4	1011.0	21.0	-23.0
PGA ADAPTER	B0151.	111	1	AREA A2	.3	1011.0	-22.0	8.0
HARNESS, OPS-UPPER R.H.	B0156.	111	1	AREA A2	.1	1011.0	-22.0	8.0
HARNESS, OPS-UPPER L.H.	B0157.	111	1	AREA A2	.1	1011.0	-22.0	8.0
TETHER, WRIST	B0154.	111	1	AREA A2	.3	1011.0	-22.0	8.0
VEST, DUAL LIFE	B0202.	111	1	JN CREW	2.4	1047.2	.0	-23.4
VEST, DUAL LIFE	B0202.	111	1	JN CREW	2.4	1047.2	.0	-23.4
VEST, DUAL LIFE	B0202.	111	1	JN CREW	2.4	1047.2	.0	-23.4
UCTA	B0205.	111	1	JN CREW	.5	1043.0	.0	-5.9
UCTA	B0205.	111	1	JN CREW	.5	1043.0	.0	-5.9
UCTA	B0223.	111	1	JN CREW	.5	1043.0	.0	-5.9
ITLSA - EV	B0211.	111	1	JN CREW COM LH STA	46.9	1043.0	-24.5	-11.9
ITLSA - EV	B0211.	111	1	JN CREW RH STA	46.9	1043.0	24.5	-11.9

3.2-36

SNA-8-D-027(III) REV 3

TABLE 3.2-9.2 (CONTINUED)

Amendment 114
9/15/71

MISSION J-2 TRANSFERRED CREW AND EQUIPMENT STORAGE LIST								
ITEMS REARRANGED IN CM PRIOR TO FIRST MID-COURSE CORRECTION (1)								
APOLLO COORDINATES								
DESCRIPTION	STOW. ITEM	REF	NO.	STORAGE LOCATION	WEIGHT	X-C.G.	Y-C.G.	Z-C.G.
EARPIECE, MOULDED (COMM. CARRIER)	E0200.1	111	1	JN CREW	NEGL	1050.0	.0	-24.0
EARPIECE, MOULDED (COMM. CARRIER)	F0200.1	111	1	JN CREW	NEGL	1050.0	.0	-24.0
EARTUBE (COMM. CARRIER)	E0200.2	111	2	JN CREW	NEGL	1050.0	.0	-24.0
EARTUBE (COMM. CARRIER)	F0200.2	111	2	JN CREW	NEGL	1050.0	.0	-24.0
CONTAINER, R12	00344.	115	1	AREA R3	2.7	1072.0	26.0	9.0
CONTAINER, EVA EQUIPMENT	00350.	111	1	AREA A2	1.3	1011.0	-22.0	8.0
HARNESS, OPS-LOWER L.H.	00158.	111	1	AREA A2	.2	1011.0	-22.0	8.0
HARNESS, OPS-LOWER L.H.	00159.	111	1	AREA A2	.2	1011.0	-22.0	8.0
CM EQUIP. RELUC.1					490.31	1042.63	-8.71	-11.99

3.2-38

SMA-B-D-027 (III) REV 3

TABLE 3.2-9.2 (CONTINUED)

MISSION J-2 TRANSFERRED CREW AND EQUIPMENT STOWAGE LIST								
ITEMS REARRANGED BY CM PRIOR TO FIRST HD-COURSE CORRECTION (2)								
APDLLO COORDINATES								
DESCRIPTION	STOW. ITEM	REF	NO.	STOWAGE LOCATION	WEIGHT	X-C.G.	Y-C.G.	Z-C.G.
CREW-COMMAND MODULE PILOT(ICMP)	N/A	227	1	OV COUCH(LH) CREW STA	139.0	1043.0	-24.5	-10.4
CREW-COMMANDER(CDR)	N/A	227	1	OV COUCH(RTR) CREW STA	154.0	1043.0	.0	-10.4
BAG, MOTION SICKNESS	A0204.	111	1	OV PGA (PGA CONT)	.1	1011.0	.0	-14.0
BAG, MOTION SICKNESS	A0204.	111	1	OV PGA (PGA CONT)	.1	1011.0	.0	-14.0
BAG, MOTION SICKNESS	A0204.	111	1	OV PGA (PGA CONT)	.1	1011.0	.0	-14.0
BAG, MOTION SICKNESS	A0204.	111	1	OV PGA (PGA CONT)	.1	1011.0	.0	-14.0
JACKET ASSY, ICG	B0112.1	111	1	OV CREW LH STA	1.8	1043.0	-24.5	-11.9
JACKET ASSY, ICG	B0112.1	111	1	OV CREW RH STA	1.8	1043.0	.0	-11.9
JACKET ASSY, ICG	B0112.1	111	1	OV CREW RH STA	1.8	1043.0	24.5	-11.9
TROUSER ASSY, ICG	B0112.2	111	1	OV CREW LH STA	1.8	1043.0	-24.5	-11.9
TROUSER ASSY, ICG	B0112.2	111	1	OV CREW RH STA	1.8	1043.0	.0	-11.9
TROUSER ASSY, ICG	B0112.2	111	1	OV CREW RH STA	1.8	1043.0	24.5	-11.9
BOOT, RIGHT, ICG	B0112.3	111	1	OV CREW LH STA	.4	1043.0	-24.5	-11.9
BOOT, RIGHT, ICG	B0112.3	111	1	OV CREW RTR STA	.4	1043.0	.0	-11.9
BOOT, RIGHT, ICG	B0112.3	111	1	OV CREW RH STA	.4	1043.0	24.5	-11.9
BOOT, LEFT, ICG	B0112.4	111	1	OV CREW LH STA	.4	1043.0	-24.5	-11.9
BOOT, LEFT, ICG	B0112.4	111	1	OV CREW UTR STA	.4	1043.0	.0	-11.9
BOOT, LEFT, ICG	B0112.4	111	1	OV CREW RH STA	.4	1043.0	24.5	-11.9
HARNES, CIG ELECTRICAL (CMP)	B0135.	111	1	OV CREW LH STA	.4	1043.0	-24.5	-11.9
HARNES, CIG ELECTRICAL (CDR)	B0135.	111	1	OV CREW UTR STA	.4	1043.0	.0	-11.9
HARNES, CIG ELECTRICAL (ICMP)	B0135.	111	1	OV CREW RH STA	.4	1043.0	24.5	-11.9
PGA ADAPTER	B0151.	111	1	AREA A7	.3	1011.0	22.0	8.0
HARNES, OPS-UPPER RH.	B0150.	111	1	AREA A7	.1	1011.0	22.0	8.0
HARNES, OPS-UPPER LH.	B0157.	111	1	AREA A7	.1	1011.0	22.0	8.0
TETHER, ANTS	B0154.	111	1	AREA A7	.3	1011.0	22.0	8.0
VEST, DUAL LIFE	B0202.	111	1	IN HSB (U2)	2.4	1033.0	-23.0	-50.0
VEST, DUAL LIFE	B0202.	111	1	IN HSB (U2)	2.4	1033.0	-23.0	-50.0
VEST, DUAL LIFE	B0202.	111	1	IN HSB (U2)	2.4	1033.0	-23.0	-50.0
UCTA	B0205.	111	1	EV CM PGA CONTAINER	.5	1015.0	.0	-20.0
UCTA	B0205.	111	1	EV CM PGA CONTAINER	.5	1015.0	.0	-20.0
UCTA	B0205.	111	1	EV CM PGA CONTAINER	.5	1015.0	.0	-20.0
ITLSA - EV	B0211.	111	1	ITLSA IN PGA CONT.	46.9	1011.0	.0	-20.0
ITLSA - EV	B0211.	111	1	ITLSA IN PGA CONT.	46.9	1011.0	.0	-20.0

3.2-39

SNA-B-D-027(111) REV 3

TABLE 3.2-9.2 (CONTINUED)

Amendment 114
9/15/71

MISSION J-2 TRANSFERRED CREW AND EQUIPMENT STORAGE LIST								
ITEMS REARRANGED IN CM PRIOR TO FIRST MID-COURSE CORRECTION (2)								
APOLLO COORDINATES								
DESCRIPTION	STOW. ITEM	REF	NO.	STOWAGE LOCATION	WEIGHT	X-C.G.	Y-C.G.	Z-C.G.
ITLSA - IV	B0212.	111	1	ITLSA IN PGA CONT.	41.8	1011.0	.0	-20.0
GLOVES, IV PAIR	B0213.	111	1	IN HSB (U2)	2.0	1033.0	-23.0	-50.0
GLOVES, IV PAIR	B0213.	111	1	IN HSB (U2)	2.0	1033.0	-23.0	-50.0
GLOVES, IV PAIR	B0213.	111	1	IN HSB (U2)	2.0	1033.0	-23.0	-50.0
HELMET ASSY,PRESSURE	B0214.	111	1	IN HSB (U2)	2.7	1033.0	-23.0	-50.0
HELMET ASSY,PRESSURE	B0214.	111	1	HELMET STOW BAG (b1)	2.7	1050.0	-27.0	39.0
HELMET ASSY,PRESSURE	B0214.	111	1	HELMET STOW BAG (L3)	2.7	1048.0	-47.0	12.0
HARNESS,ELEC - SUIT	B0224.	111	1	ON CREW CTR STA	.4	1043.0	.0	-11.9
HARNESS,ELEC - SUIT	B0224.	111	1	ON CREW LH STA	.4	1043.0	-24.5	-11.9
HARNESS,3IG INSTRUMENTATION	B0216.	111	1	ON CREW CTR STA	.2	1043.0	.0	-11.9
HARNESS,3IG INSTRUMENTATION	B0216.	111	1	ON CREW LH STA	.2	1043.0	-24.5	-11.9
COMMUNICATION CARRIER	B0217.	111	1	IN HSB (U2)	1.6	1033.0	-23.0	-50.0
COMMUNICATION CARRIER	B0217.	111	1	HELMET STOW BAG (b1)	1.6	1050.0	-27.0	39.0
COMMUNICATION CARRIER	B0217.	111	1	HELMET STOW BAG (L3)	1.6	1048.0	-47.0	12.0
POCKET,SCISSORS (CMP)	B0218.	111	1	ON ICG LH STA	.2	1043.0	-24.5	-11.9
POCKET,SCISSORS (CDK)	B0218.	111	1	ON ICG CTR STA	.2	1043.0	.0	-11.9
POCKET,SCISSORS (LMP)	B0218.	111	1	ON ICG RH STA	.2	1043.0	24.5	-11.9
POCKET,CHECKLIST (CDK)	B0219.	111	1	ON ICG CTR STA	.2	1043.0	.0	-11.9
POCKET,CHECKLIST (LMP)	B0219.	111	1	ON ICG RH STA	.2	1043.0	24.5	-11.9
POCKET,DATA(CDP)	B0220.	111	1	ON ICG CTR STA	.2	1043.0	.0	-11.9
POCKET,DATA(LMP)	B0220.	111	1	ON ICG RH STA	.2	1043.0	24.5	-11.9
POCKET,CHECKLIST (CMP)	B0221.	111	1	ON ICG LH STA	.2	1043.0	-24.5	-11.9
POCKET,DATA(CMP)	B0222.	111	1	ON ICG LH STA	.2	1043.0	-24.5	-11.9
JOSIMETER, PASSIVE	D0201.	117	3	CARGO POKETS	NEGL	1041.0	.0	-11.9
JOSIMETER, PASSIVE	D0201.	117	3	CARGO POKETS	NEGL	1041.0	.0	-11.9
HEADSET,LIGHTWEIGHT	E0111.	111	1	ON CREW LH STA	.4	1043.0	-24.5	-11.9
HEADSET,LIGHTWEIGHT	E0112.	111	1	ON CREW CTR STA	.4	1043.0	.0	-11.9
HEADSET,LIGHTWEIGHT	E0113.	111	1	ON CREW RH STA	.4	1043.0	24.5	-11.9
EARTUBE,UNIVERSAL (CMP)	E0114.	111	1	ON ICG LH STA	NEGL	1043.0	-24.5	-11.9
EARTUBE,UNIVERSAL (CDK)	E0115.	111	1	ON ICG CTR STA	NEGL	1043.0	.0	-11.9
EARTUBE,UNIVERSAL (LMP)	E0116.	111	1	ON ICG RH STA	NEGL	1043.0	24.5	-11.9
EARTUBE,MOULDED (COMM.CARRIER)	F1200.1	111	1	IN HSB (U2)	NEGL	1033.0	-23.0	-50.0

3.2-40

SNA-8-D-027(111) REV 3

TABLE 3.2-9.2 (CONTINUED)

Amendment 114
9/15/71

MISSION J-2 TRANSFERRED CREW AND EQUIPMENT STORAGE LIST								
ITEMS REARRANGED IN CM PRIOR TO FIRST MID-COURSE CORRECTION (2)								
APPLIED COORDINATES								
DESCRIPTION	STOW. ITEM	REF	NO.	STOWAGE LOCATION	WEIGHT	X-C.G.	Y-C.G.	Z-C.G.
EAPPIECE, MOULDED (COMM. CARRIER)	E0200.1	111	1	14 HSB (02)	NEGL	1033.0	-23.0	-50.0
EAPPIECE, MOULDED (COMM. CARRIER)	E0200.1	111	1	14 HSB (02)	NEGL	1033.0	-23.0	-50.0
EARTJUE (COMM. CARRIER)	E0200.2	111	2	14 HSB (02)	NEGL	1033.0	-23.0	-50.0
EARTJUE (COMM. CARRIER)	E0200.2	111	2	HELMET STOW BAG (01)	NEGL	1050.0	-27.0	39.0
EARTJUE (COMM. CARRIER)	E0200.2	111	2	14 HSB (02)	NEGL	1033.0	-23.0	-50.0
CONTAINER, R12	00364.	115	1	R4 GIRTH RING	2.7	1034.0	41.0	-21.0
CONTAINER, EVA EQUIPMENT	00358.	111	1	AREA A7	1.3	1011.0	22.0	8.0
HARNES, JPS-LOWER L.H.	00158.	111	1	AREA A7	.2	1011.0	22.0	8.0
HARNES, JPS-LOWER L.H.	00159.	111	1	AREA A7	.2	1011.0	22.0	8.0
CM EQUIP. RELOC. 1					420.31	1033.58	-8.11	-13.89

3.2-41

SNA-8-D-027(111) REV 3

U
N
I
T
E
D
S
T
A
T
E
S
O
F
A
M
E
R
I
C
A

W
H
E
E
L
I
N
E
L
I
S
T
O
F
I
T
E
M
S
I
N
T
H
E
A
P
O
L
L
O
M
I
S
S
I
O
N
J
-
2
T
R
A
N
S
F
E
R
R
E
D
C
R
E
W
A
N
D
E
Q
U
I
P
M
E
N
T
S
T
O
R
A
G
E
L
I
S
T

TABLE 3.2-9.2 (CONTINUED)

MISSION J-2 TRANSFERRED CREW AND EQUIPMENT STORAGE LIST								
ITEMS REARRANGED IN CM PRIOR TO L4 ACTIVATION (3)								
APOLLO COORDINATES								
DESCRIPTION	STOR. ITEM	REF.	NO.	STORAGE LOCATION	WEIGHT	X-C.G.	Y-C.G.	Z-C.G.
BAG, MOTION SICKNESS	A0208.	111	1	ON PGA (PGA CONT)	.1	1011.0	.0	-14.0
BAG, MOTION SICKNESS	A0208.	111	1	ON PGA (PGA CONT)	.1	1011.0	.0	-14.0
BAG, MOTION SICKNESS	A0208.	111	1	ON PGA (PGA CONT)	.1	1011.0	.0	-14.0
JACKET ASSY, ICG	B0112.1	111	1	ON CREW LH STA	1.8	1043.0	-24.5	-11.9
JACKET ASSY, ICG	B0112.1	111	1	ON CREW CTR STA	1.8	1043.0	.0	-11.9
JACKET ASSY, ICG	B0112.1	111	1	ON CREW RH STA	1.8	1043.0	24.5	-11.9
TROUSER ASSY, ICG	B0112.2	111	1	ON CREW LH STA	1.8	1043.0	-24.5	-11.9
TROUSER ASSY, ICG	B0112.2	111	1	ON CREW CTR STA	1.8	1043.0	.0	-11.9
TROUSER ASSY, ICG	B0112.2	111	1	ON CREW RH STA	1.8	1043.0	24.5	-11.9
BOOT, RIGHT, ICG	B0112.3	111	1	ON CREW LH STA	.4	1043.0	-24.5	-11.9
BOOT, RIGHT, ICG	B0112.3	111	1	ON CREW CTR STA	.4	1043.0	.0	-11.9
BOOT, RIGHT, ICG	B0112.3	111	1	ON CREW RH STA	.4	1043.0	24.5	-11.9
BOOT, LEFT, ICG	B0112.4	111	1	ON CREW LH STA	.4	1043.0	-24.5	-11.9
BOOT, LEFT, ICG	B0112.4	111	1	ON CREW CTR STA	.4	1043.0	.0	-11.9
BOOT, LEFT, ICG	B0112.4	111	1	ON CREW RH STA	.4	1043.0	24.5	-11.9
SUBSYSTEM, FECAL CONTAINMENT	B0113.	111	*1	AREA A2	.3	1011.0	-22.0	8.0
SUBSYSTEM, FECAL CONTAINMENT	B0113.	111	*1	AREA A2	.3	1011.0	-22.0	8.0
SUBSYSTEM, FECAL CONTAINMENT	B0113.	111	1	AREA A2	.3	1011.0	-22.0	8.0
HARNES, CAB ELECTRICAL (CMP)	B0135.	111	1	ON CREW LH STA	.4	1043.0	-24.5	-11.9
HARNES, CAB ELECTRICAL (COR)	B0135.	111	1	ON CREW CTR STA	.4	1043.0	.0	-11.9
HARNES, CAB ELECTRICAL (LMP)	B0135.	111	1	ON CREW RH STA	.4	1043.0	24.5	-11.9
JCTA	B0205.	111	1	IN CM PGA CONTAINER	.5	1015.0	.0	-20.0
JCTA	B0205.	111	1	IN CM PGA CONTAINER	.5	1015.0	.0	-20.0
JCTA	B0221.	111	1	IN CM PGA CONTAINER	.5	1015.0	.0	-20.0
ITLSA - EV	B0211.	111	1	ITLSA IN PGA CONT.	46.9	1011.0	.0	-20.0
ITLSA - EV	B0211.	111	1	ITLSA IN PGA CONT.	46.9	1011.0	.0	-20.0
ITLSA - IV	B0212.	111	1	ITLSA IN PGA CONT.	41.9	1011.0	.0	-20.0
GLOVES, IV PAIR	B0213.	111	1	IN HSB (U2)	2.0	1033.0	-23.0	-50.0
GLOVES, IV PAIR	B0213.	111	1	IN HSB (U2)	2.0	1033.0	-23.0	-50.0
GLOVES, IV PAIR	B0213.	111	1	IN HSB (U2)	2.0	1033.0	-23.0	-50.0
HELMET ASSY, PRESSURE	B0214.	111	1	IN HSB (U2)	2.7	1033.0	-23.0	-50.0
HELMET ASSY, PRESSURE	B0214.	111	2	HELMET STOW BAG (H1)	2.7	1050.0	-27.0	39.0

3.2-42

SNA-8-D-027(111) REV 3

TABLE 3.2-9.2 (CONTINUED)

Amendment 114
9/15/71

MISSION J-2 TRANSFERRED CREW AND EQUIPMENT STORAGE LIST								
ITEMS REARRANGED IN CM PRIOR TO L4 ACTIVATION (3)								
APOLLO COORDINATES								
DESCRIPTION	STOW. ITEM	REF	NO.	STORAGE LOCATION	WEIGHT	X-C.O.	Y-C.O.	Z-C.O.
HELMET ASSY, PRESSURE	80214.	111	1	HELMET STOW. BAG (L3)	2.7	1048.0	-47.0	12.0
COMMUNICATION CARRIER	80217.	111	1	IN HSB (U2)	1.6	1033.0	-23.0	-50.0
COMMUNICATION CARRIER	80217.	111	1	HELMET STOW. BAG (B1)	1.6	1050.0	-27.0	39.0
COMMUNICATION CARRIER	80217.	111	1	HELMET STOW. BAG (L3)	1.6	1048.0	-47.0	12.0
POCKET, SCISSORS (CMP)	80218.	111	1	ON ICG LH STA	.2	1043.0	-24.5	-11.9
POCKET, SCISSORS (CR)	80218.	111	1	ON ICG CR STA	.2	1043.0	.0	-11.9
POCKET, SCISSORS (LMP)	80218.	111	1	ON ICG LH STA	.2	1043.0	24.5	-11.9
POCKET, CHECKLIST (CR)	80219.	111	1	ON ICG CR STA	.2	1043.0	.0	-11.9
POCKET, CHECKLIST (LMP)	80219.	111	1	ON ICG CR STA	.2	1043.0	24.5	-11.9
POCKET, CATA(CR)	80220.	111	1	ON ICG CR STA	.2	1043.0	.0	-11.9
POCKET, CATA(LMP)	80220.	111	1	ON ICG CR STA	.2	1043.0	24.5	-11.9
POCKET, CHECKLIST (CMP)	80221.	111	1	ON ICG LH STA	.2	1043.0	-24.5	-11.9
POCKET, CATA(CMP)	80222.	111	1	ON ICG LH STA	.2	1043.0	-24.5	-11.9
CAP, ELECTRICAL CONNECTOR	80138.	111	1	PGA CONTAINER	NEGL	1015.0	.0	-3.5
CAP, ELECTRICAL CONNECTOR	80138.	111	1	PGA CONTAINER	NEGL	1015.0	.0	-3.5
CAP, PROTECTIVE-CWG BIO HARNESS	80112.35	111	1	AREA P8	NEGL	1052.0	46.0	12.0
CAP, PROTECTIVE-CWG BIO HARNESS	80112.35	111	1	AREA P8	NEGL	1052.0	46.0	12.0
DOSIMETER, PASSIVE	80201.	117	3	CWG POCKETS	NEGL	1041.0	.0	-11.9
DOSIMETER, PASSIVE	80201.	117	3	CWG POCKETS	NEGL	1041.0	.0	-11.9
HEADSET, LIGHTWEIGHT	E0111.	111	1	ON CREW LH STA	.4	1043.0	-24.5	-11.9
HEADSET, LIGHTWEIGHT	E0112.	111	1	ON CREW CR STA	.4	1043.0	.0	-11.9
HEADSET, LIGHTWEIGHT	E0113.	111	1	ON CREW RH STA	.4	1043.0	24.5	-11.9
EARTUBE, UNIVERSAL (CMP)	E0114.	111	1	ON ICG LH STA	NEGL	1043.0	-24.5	-11.9
EARTUBE, UNIVERSAL (CR)	E0115.	111	1	ON ICG CR STA	NEGL	1043.0	.0	-11.9
EARTUBE, UNIVERSAL (LMP)	E0116.	111	1	ON ICG CR STA	NEGL	1043.0	24.5	-11.9
EARTPIECE, MODULE(COMM. CARRIER)	E0200.1	111	1	IN HSB (U2)	NEGL	1033.0	-23.0	-50.0
EARTPIECE, MODULE(COMM. CARRIER)	E0200.1	111	1	IN HSB (U2)	NEGL	1033.0	-23.0	-50.0
EARTPIECE, MODULE(COMM. CARRIER)	E0200.1	111	1	IN HSB (U2)	NEGL	1033.0	-23.0	-50.0
EARTUBE(COMM. CARRIER)	E0200.2	111	2	IN HSB (U2)	NEGL	1033.0	-23.0	-50.0
EARTUBE(COMM. CARRIER)	E0200.2	111	2	HELMET STOW. BAG (B1)	NEGL	1050.0	-27.0	39.0
EARTUBE(COMM. CARRIER)	E0200.2	111	2	IN HSB (U2)	NEGL	1033.0	-23.0	-50.0
CM EQUIP. REFLOC.2					174.61	1017.39	-3.29	-18.57

3.2-43

SNA-8-D-027(111) REV 3

TABLE 3.2-9.2 (CONTINUED)

Amendment 114
9/15/71

MISSION J-2 TRANSFERRED CREW AND EQUIPMENT STORAGE LIST								
ITEMS REARRANGED IN CM PRIOR TO L4 ACTIVATION (4)								
APOLLO COORDINATES								
DESCRIPTION	STOW. ITEM	REF.	NJ.	STORAGE LOCATION	WEIGHT	X-C.G.	Y-C.G.	Z-C.G.
BAG, MOTION SICKNESS	A0206.	111	1	JN CREW	.1	1043.0	.0	-21.0
BAG, MOTION SICKNESS	A0206.	111	1	JN CREW	.1	1043.0	.0	-21.0
BAG, MOTION SICKNESS	A0208.	111	1	JN CREW	.1	1043.0	.0	-21.0
JACKET ASSY, ICG	B0112.1	111	1	AREA U2	1.8	1033.0	-23.0	-50.0
JACKET ASSY, ICG	B0112.1	111	1	AREA U2	1.8	1033.0	-23.0	-50.0
JACKET ASSY, ICG	B0112.1	111	1	AREA U2	1.8	1033.0	-23.0	-50.0
TROUSER ASSY, ICG	B0112.2	111	1	AREA U2	1.8	1033.0	-23.0	-50.0
TROUSER ASSY, ICG	B0112.2	111	1	AREA U2	1.8	1033.0	-23.0	-50.0
TROUSER ASSY, ICG	B0112.2	111	1	AREA U2	1.8	1033.0	-23.0	-50.0
TROUSER ASSY, ICG	B0112.2	111	1	AREA U2	1.8	1033.0	-23.0	-50.0
BOOT, RIGHT, ICG	B0112.3	111	1	AREA U2	.4	1033.0	-23.0	-50.0
BOOT, RIGHT, ICG	B0112.3	111	1	AREA U2	.4	1033.0	-23.0	-50.0
BOOT, RIGHT, ICG	B0112.3	111	1	AREA U2	.4	1033.0	-23.0	-50.0
BOOT, LEFT, ICG	B0112.4	111	1	AREA U2	.4	1033.0	-23.0	-50.0
BOOT, LEFT, ICG	B0112.4	111	1	AREA U2	.4	1033.0	-23.0	-50.0
BOOT, LEFT, ICG	B0112.4	111	1	AREA U2	.4	1033.0	-23.0	-50.0
BOOT, LEFT, ICG	B0112.4	111	1	AREA U2	.4	1033.0	-23.0	-50.0
SUBSYSTEM, FECAL CONTAINMENT	B0113.	111	*1	JN CREW CTR STA	.3	1043.0	.0	-11.9
SUBSYSTEM, FECAL CONTAINMENT	B0113.	111	*1	JN CREW RH STA	.3	1043.0	24.5	-11.9
SUBSYSTEM, FECAL CONTAINMENT	B0113.	111	1	JN CREW LH STA	.3	1043.0	-24.5	-11.9
HARNES, CWG ELECTRICAL (CMP)	B0135.	111	1	IN ADAPTER BAG(AH)	.4	1011.0	21.0	-23.0
HARNES, CWG ELECTRICAL (CDK)	B0135.	111	1	IN ADAPTER BAG(AH)	.4	1011.0	21.0	-23.0
HARNES, CWG ELECTRICAL (LMP)	B0135.	111	1	IN ADAPTER BAG(AH)	.4	1011.0	21.0	-23.0
UCTA	B0205.	111	1	JN CREW	.5	1043.0	.0	-5.9
UCTA	B0205.	111	1	JN CREW	.5	1043.0	.0	-5.9
UCTA	B0223.	111	1	JN CREW	.5	1043.0	.0	-5.9
ITLSA - EV	B0211.	111	1	JN CREW CTR STA	46.9	1043.0	.0	-11.9
ITLSA - EV	B0211.	111	1	JN CREW RH STA	46.9	1043.0	24.5	-11.9
ITLSA - IV	B0212.	111	1	JN CREW LH STA	41.8	1043.0	-24.5	-11.9
GLOVES, IV PAIR	B0213.	111	1	JN CREW LH STA	2.0	1043.0	-24.5	-11.9
GLOVES, IV PAIR	B0213.	111	1	JN CREW RH STA	2.0	1043.0	24.5	-11.9
GLOVES, IV PAIR	B0213.	111	1	JN CREW CTR STA	2.0	1043.0	.0	-11.9
HELMET ASSY, PRESSURE	B0214.	111	1	JN CREW LH STA	2.7	1043.0	-24.5	-11.9
HELMET ASSY, PRESSURE	B0214.	111	1	JN CREW RH STA	2.7	1043.0	24.5	-11.9

3.2-44

SNA-8-D-027(III) REV 3

UNITED STATES GOVERNMENT

TABLE 3.2-9.2 (CONTINUED)

Amendment 114
9/15/71

MISSION J-2 TRANSFERRED CREW AND EQUIPMENT STORAGE LIST								
ITEMS REARRANGED IN CM PRIOR TO L4 ACTIVATION (4)								
					APOLLO COORDINATES			
DESCRIPTION	STOW. ITEM	REF	NO.	STORAGE LOCATION	WEIGHT	X-C.G.	Y-C.G.	Z-C.G.
HELMET ASSY,PRESSURE	B0214.	111	1	J4 CREW LHM STA	2.7	1043.0	.0	-11.9
COMMUNICATION CARRIER	B0217.	111	1	J4 CREW LHM STA	1.6	1043.0	-24.5	-11.9
COMMUNICATION CARRIER	B0217.	111	1	J4 CREW RH STA	1.6	1043.0	24.5	-11.9
COMMUNICATION CARRIER	B0217.	111	1	J4 CREW UTK STA	1.6	1043.0	.0	-11.9
POCKET, SCISSORS (CMP)	B0218.	111	1	DN PLA LH CREW STA	.2	1043.0	-24.5	-11.9
POCKET, SCISSORS (CDK)	B0218.	111	1	DN PLA CT CREW STA	.2	1043.0	.0	-11.9
POCKET, SCISSORS (LMP)	B0218.	111	1	DN PGA RH CREW STA	.2	1043.0	24.5	-11.9
POCKET,CHECKLIST (CDK)	B0219.	111	1	J4 PLA CT CREW STA	.2	1043.0	.0	-11.9
POCKET,CHECKLIST (LMP)	B0219.	111	1	J4 PLA RH CREW STA	.2	1043.0	24.5	-11.9
POCKET,DATA(CDK)	B0220.	111	1	J4 PGA CT CREW STA	.2	1043.0	.0	-11.9
POCKET,DATA(LMP)	B0220.	111	1	J4 PGA RH CREW STA	.2	1043.0	24.5	-11.9
POCKET,CHECKLIST (LMP)	B0221.	111	1	J4 PGA LH CREW STA	.2	1043.0	-24.5	-11.9
POCKET,DATA(CMP)	B0222.	111	1	J4 PGA LH CREW STA	.2	1043.0	-24.5	-11.9
CAP,ELECTRICAL CONNECTOR	B0138.	111	1	J4 CREW RH STA	NEGL	1043.0	24.5	-11.9
CAP,ELECTRICAL CONNECTOR	B0138.	111	1	J4 CREW UTK STA	NEGL	1043.0	.0	-11.9
CAP,PROTECTIVE-LHG STD HARNESS	C0112.35	111	1	J4 CREW RH STA	NEGL	1043.0	24.5	-11.9
CAP,PROTECTIVE-LHG STD HARNESS	C0112.35	111	1	J4 CREW UTK STA	NEGL	1043.0	.0	-11.9
JOSIMETER, PASSIVE	D0201.	117	3	CAS POCKET(STOWED)	NEGL	1015.0	.0	-19.0
JOSIMETER, PASSIVE	D0201.	117	3	CAS POCKET(STOWED)	NEGL	1015.0	.0	-19.0
HEADSET,LIGHTWEIGHT	E0111.	111	1	AREA A5	.4	1011.0	21.0	-23.0
HEADSET,LIGHTWEIGHT	E0112.	111	1	AREA A8	.4	1011.0	21.0	-23.0
HEADSET,LIGHTWEIGHT	E0113.	111	1	AREA A8	.4	1011.0	21.0	-23.0
EARTUBE,UNIVERSAL (CMP)	E0114.	111	1	AREA U2	NEGL	1033.0	-23.0	-50.0
EARTUBE,UNIVERSAL (CDK)	E0115.	111	1	AREA U2	NEGL	1033.0	-23.0	-50.0
EARTUBE,UNIVERSAL (LMP)	E0115.	111	1	AREA U2	NEGL	1033.0	-23.0	-50.0
EARTUBE,MODULE(COMM.CARRIER)	F0200.1	111	2	J4 CREW	NEGL	1050.0	.0	-24.0
EARTUBE,MODULE(COMM.CARRIER)	F0200.1	111	1	J4 CREW	NEGL	1050.0	.0	-24.0
EARTUBE,MODULE(COMM.CARRIER)	F0200.1	111	1	J4 CREW	NEGL	1050.0	.0	-24.0
EARTUBE(COMM.CARRIER)	F0200.2	111	2	J4 CREW	NEGL	1050.0	.0	-24.0
EARTUBE(COMM.CARRIER)	F0200.2	111	2	J4 CREW	NEGL	1050.0	.0	-24.0
EARTUBE(COMM.CARRIER)	F0200.2	111	2	J4 CREW	NEGL	1050.0	.0	-24.0
L4 EQUIP. RELOC.2					174.61	1041.80	-0.73	-14.90

3.2-45

SMA-B-D-027(111) REV 3

TABLE 3.2-9.2 (CONTINUED)

Amendment 114
9/15/71

MISSION J-2 TRANSFERRED CREW AND EQUIPMENT STORAGE LIST								
ITEMS TRANSFERRED FROM CM INTO LM AT LM ACTIVATION (S)								
DESCRIPTION	STOW. ITEM	REF.	NO.	STORAGE LOCATION	WEIGHT	APELLO COORDINATES		
						X-C.G.	Y-C.G.	Z-C.G.
CREW-COMMANDER (CMK)	N/A	227	1	ON COUCH/CTR CREW STA	164.0	1043.0	.0	-10.4
CREW-LM PILOT (LMP)	N/A	227	1	ON COUCH/CTR CREW STA	160.5	1043.0	24.5	-10.4
BAG, XFER, 16MM MAGAZINE	06397.	111	1	AREA R13	.3	1024.0	45.0	-26.0
BAG, XFER, 70MM MAGAZINE	06398.	111	1	AREA R13	.5	1024.0	45.0	-26.0
BAG, TRANSFER-16MM MAG. (2)	06432.	111	*1	AREA R13	.1	1024.0	45.0	-26.0
BAG, TRANSFER-70MM MAG. (3)	06434.	111	*1	AREA R13	.5	1024.0	45.0	-26.0
MAGAZINE, 16MM DATA ACQ.	A0101.1	116	5	IN XFER BAG (R13)	5.0	1024.0	45.0	-26.0
MAGAZINE, 16MM DATA ACQ.	A0101.1	116	2	IN XFER BAG (R13)	2.0	1024.0	45.0	-26.0
MAGAZINE, 16MM DATA ACQ.	A0101.1	116	1	IN XFER BAG (R13)	1.0	1024.0	45.0	-26.0
MAGAZINE, L.S. HASSELBLAD	A0108.1	116	3	IN XFER BAG (R13)	4.2	1024.0	45.0	-26.0
MAGAZINE, L.S. HASSELBLAD	A0108.1	116	1	IN XFER BAG (R13)	1.4	1024.0	45.0	-26.0
MAGAZINE, L.S. HASSELBLAD	A0108.1	116	3	IN XFER BAG (R13)	4.2	1024.0	45.0	-26.0
DOSIMETER, PASSIVE RADIATION	D0101.	111	1	IN XFER BAG (R13)	NEGL	1024.0	45.0	-26.0
MAGAZINE, L.S. HASSELBLAD	A0108.2	111	2	IN XFER BAG (AH)	2.8	1011.0	21.0	-23.0
MAGAZINE, L.S. HASSELBLAD	A0108.2	111	3	IN XFER BAG (R13)	4.2	1024.0	45.0	-26.0
LM XFR DATA CAPD KIT	A0114.18	114	1	AREA R3	.6	1072.0	26.0	9.0
LM LUNAR SURFACE CHECKLIST	A0114.19	114	1	IN FDF (R3)	1.0	1072.0	26.0	9.0
LM SYSTEMS ACTIVATION CHK. LST.	A0114.12	114	1	IN FDF (R3)	.5	1072.0	26.0	9.0
LM SYSTEMS ACTIVATION CHK. LST.	A0114.12	114	1	IN FDF (R3)	.5	1072.0	26.0	9.0
LM LUNAR SURFACE MAPS	A0114.13	114	1	IN FDF (R3)	1.5	1072.0	26.0	9.0
LM TIE LINE BOOK	A0114.14	114	1	IN FDF (R3)	.5	1072.0	26.0	9.0
LM DATA CARD BULK	A0114.19	114	1	IN FDF (R3)	.3	1072.0	26.0	9.0
LM RNDZ/ABORT BULK	A0114.22	114	1	IN FDF (R3)	.3	1072.0	26.0	9.0
MONOCULAR 10X40	A0130.	116	1	AREA U4	.7	1038.0	39.0	-43.0
SUNGLASSES	A0200.	111	1	ON CREW	.1	1042.8	-7.6	-20.7
SUNGLASSES	A0200.	111	1	ON CREW	.1	1042.8	-7.6	-20.7
POUCH, SUNGLASSES	A0201.	111	1	ON CREW	NEGL	1042.8	-7.6	-20.7
POUCH, SUNGLASSES	A0201.	111	1	ON CREW	NEGL	1042.8	-7.6	-20.7
CHRONOGRAPH - 002	A0202.	111	1	ON CREW	.1	1050.0	.0	-14.9
CHRONOGRAPH - 002	A0202.	111	1	ON CREW	.1	1050.0	.0	-14.9
WATCHBAND	A0203.	111	1	ON CREW	NEGL	1050.0	.0	-14.9
WATCHBAND	A0203.	111	1	ON CREW	NEGL	1050.0	.0	-14.9

3.2-46

SNA-8-D-027(III) REV 3

TABLE 3.2-9.2 (CONTINUED)

Amendment 114
9/15/71

MISSION J-2 TRANSFERRED CREW AND EQUIPMENT STORAGE LIST								
ITEMS TRANSFERRED FROM CM INTD LM AT LM ACTIVATION (5)								
APOLLO COORDINATES								
DESCRIPTION	STOW. ITEM	REF	NO.	STORAGE LOCATION	WFLIGHT	X-C.G.	Y-C.G.	Z-C.G.
HARNESS, SIG INSTRUMENTATION	B0216.	111	1	JN CREW RH STA	.2	1043.0	24.5	-11.9
COMMUNICATION CARRIER	B0217.	111	1	JN CREW RH STA	1.6	1043.0	24.5	-11.9
COMMUNICATION CARRIER	B0217.	111	1	JN CREW LTR STA	1.6	1043.0	.0	-11.9
POCKET, SCISSORS (COK)	B0218.	111	1	JN PGA CT CREW STA	.2	1043.0	.0	-11.9
POCKET, SCISSORS (LMP)	B0218.	111	1	JN PGA RH CREW STA	.2	1043.0	24.5	-11.9
POCKET, CHECKLIST (COK)	B0219.	111	1	JN PGA CT CREW STA	.2	1043.0	.0	-11.9
POCKET, CHECKLIST (LMP)	B0219.	111	1	JN PGA RH CREW STA	.2	1043.0	24.5	-11.9
POCKET, DATA (COK)	B0220.	111	1	JN PGA CT CREW STA	.2	1043.0	.0	-11.9
POCKET, DATA (LMP)	B0220.	111	1	JN PGA RH CREW STA	.2	1043.0	24.5	-11.9
CAP, ELECTRICAL CONNECTOR	B0138.	111	1	JN CREW RH STA	NEGL	1043.0	24.5	-11.9
CAP, ELECTRICAL CONNECTOR	B0138.	111	1	JN CREW LTR STA	NEGL	1043.0	.0	-11.9
CAP, PROTECTIVE-CWG BIO HARNESS	C0112.35	111	1	JN CREW RH STA	NEGL	1043.0	24.5	-11.9
CAP, PROTECTIVE-CWG BIO HARNESS	C0112.35	111	1	JN CREW LTR STA	NEGL	1043.0	.0	-11.9
ASSY, SIG INSTRUMENTATION	C0201.	111	1	JN CREW	1.1	1041.0	.0	-12.9
ASSY, SIG INSTRUMENTATION	C0201.	111	1	JN CREW	1.1	1041.0	.0	-12.9
DOSIMETER, PERSONAL	D0200.	117	1	JN CREW	.4	1046.0	.0	-23.4
DOSIMETER, PERSONAL	D0200.	117	1	JN CREW	.4	1046.0	.0	-23.4
DOSIMETER, PASSIVE	D0201.	117	3	CWG POCKET (STOWED)	NEGL	1015.0	.0	-19.0
DOSIMETER, PASSIVE	D0201.	117	3	CWG POCKET (STOWED)	NEGL	1015.0	.0	-19.0
HEADSET, LIGHTWEIGHT	E0112.	111	1	AREA A8	.4	1011.0	21.0	-23.0
HEADSET, LIGHTWEIGHT	E0113.	111	1	AREA A6	.4	1011.0	21.0	-23.0
EARPIECE, MOULDED (COMM. CARRIER)	E0200.1	111	1	JN CREW	NEGL	1050.0	.0	-24.0
EARPIECE, MOULDED (COMM. CARRIER)	E0200.1	111	1	JN CREW	NEGL	1050.0	.0	-24.0
EARTUBE (COMM. CARRIER)	E0200.2	111	2	JN CREW	NEGL	1050.0	.0	-24.0
EARTUBE (COMM. CARRIER)	E0200.2	111	2	JN CREW	NEGL	1050.0	.0	-24.0
BAG, 70MM MAGAZINE XFR	06466.	111	1	AREA A8	.3	1011.0	21.0	-23.0
BAG, 70MM MAGAZINE XFR	06466.	111	1	AREA K13	.3	1024.0	45.0	-26.0
UTILITY STRAP	06315.	111	3	AREA K-5	.1	1059.0	44.0	15.0
INFLIGHT RETAINER STRAPS	00360.	111	4	AREA K-5	NEGL	1059.0	44.0	15.0
2 CREW EQUIP, CM-LM					485.02	1041.68	14.03	-12.24

3.2-48

SMA-8-D-027(III) REV 3

U
S
S
P
A
C
E
A
G
E
N
C
Y

TABLE 3.2-9.2 (CONTINUED)

Amendment 114
9/15/71

MISSION J-2 TRANSFERRED CREW AND EQUIPMENT STORAGE LIST								
ITEMS TRANSFERRED FROM CM INTO LM AT LM ACTIVATION (6)								
DESCRIPTION	STOW. ITEM	REF	NO.	STOWAGE LOCATION	WEIGHT	LM COORDINATES		
						X-C.G.	Y-C.G.	Z-C.G.
CREW-COMMANDER(COR)	N/A	227	1	CREW STATION - LH	164.0	252.0	-22.0	44.0
CREW-LM PILOT(LMP)	N/A	227	1	CREW STATION - RH	160.5	252.0	22.0	38.0
BAG, XFER, 16MM MAGAZINE	U6397.	111	1	F7L	.3	241.8	36.0	47.3
BAG, XFER, 70MM MAGAZINE	U6398.	111	1	F7J	.5	238.0	38.0	38.4
BAG, TRANSFER-16MM MAG. (2)	U6432.	111	*1	ISA (F6)	.1	270.0	.0	52.8
BAG, TRANSFER-70MM MAG (3)	U6434.	111	*1	F7P	.5	241.0	38.0	53.4
MAGAZINE, 16MM DATA ACQ.	AJ101.1	116	5	IN XFR BAG (F7L)	5.0	231.8	36.0	47.3
MAGAZINE, 16MM DATA ACQ.	AJ101.1	116	2	ISA (F6)	2.0	270.0	.0	52.8
MAGAZINE, 16MM DATA ACQ.	AJ101.1	116	1	CN CAMERA (F5)	1.0	286.0	17.8	66.6
MAGAZINE, L.S. HASSELBLAD	AJ108.1	116	3	IN XFR BAG (F7D)	4.2	238.0	38.0	38.4
MAGAZINE, L.S. HASSELBLAD	AJ108.1	116	1	CN CAMERA (F7C)	1.4	242.8	38.0	41.0
MAGAZINE, L.S. HASSELBLAD	AJ108.1	116	3	IN XFR BAG (F7P)	4.2	241.0	38.0	53.4
DOSIMETER, PASSIVE RADIATION	AD101.	111	1	IN XFR BAG (F7L)	NEGL	231.8	36.0	47.3
MAGAZINE, L.S. HASSELBLAD	AJ108.2	111	2	A14A	2.8	243.7	-5.5	-14.8
MAGAZINE, L.S. HASSELBLAD	AJ108.2	111	3	A14A	4.2	243.7	-5.5	-14.8
LM XFR DATA CARD KIT	AJ114.18	114	1	A1A	.6	280.0	-19.0	13.5
LM LUNAR SURFACE CHECKLIST	AJ114.10	114	1	LM XFR DATA CARD KIT	1.0	280.0	-19.0	13.5
LM SYSTEMS ACTIVATION CHK.LST.	AJ114.12	114	1	LM XFR DATA CARD KIT	.5	280.0	-19.0	13.5
LM SYSTEMS ACTIVATION CHK.LST.	AJ114.12	114	1	LM XFR DATA CARD KIT	.5	280.0	-19.0	13.5
LM LUNAR SURFACE MAPS	AJ114.13	114	1	LM XFR DATA CARD KIT	1.5	280.0	-19.0	13.5
LM TIMELINE BOOK	AJ114.14	114	1	LM XFR DATA CARD KIT	.5	280.0	-19.0	13.5
LM DATA CARD BOOK	AJ114.19	114	1	LM XFR DATA CARD KIT	.3	280.0	-19.0	13.5
LM RNJZ/AJORT BOOK	AJ114.22	114	1	LM XFR DATA CARD KIT	.3	280.0	-19.0	13.5
MONOCULAR 10X40	A0130.	116	1	F7J	.7	238.4	38.6	46.0
SUNGLASSES	A0200.	111	1	J4 CREW (LH CREW STA)	.1	252.0	-22.0	44.0
SUNGLASSES	A0200.	111	1	J4 CREW (RH CREW STA)	.1	252.0	22.0	38.0
PUUCH, SUNGLASSES	A0201.	111	1	J4 CREW (LH CREW STA)	NEGL	252.0	-22.0	44.0
PUUCH, SUNGLASSES	A0201.	111	1	J4 CREW (RH CREW STA)	NEGL	252.0	22.0	38.0
CHRONOGRAPH - 002	A0202.	111	1	J4 CREW (LH CREW STA)	.1	252.0	-22.0	44.0
CHRONOGRAPH - 002	A0202.	111	1	J4 CREW (RH CREW STA)	.1	252.0	22.0	38.0
WATCHBAND	A0203.	111	1	J4 CREW (LH CREW STA)	NEGL	252.0	-22.0	44.0
WATCHBAND	A0203.	111	1	J4 CREW (RH CREW STA)	NEGL	252.0	22.0	38.0

3.2-49
SNA-8-D-027(III) REV 3

TABLE 3.2-9.2 (CONTINUED)

Amendment 114
9/15/71

MISSION J-2 TRANSFERRED CREW AND EQUIPMENT STORAGE LIST								
ITEMS TRANSFERRED FROM CM INTO LM AT LM ACTIVATION (6)								
DESCRIPTION	STOW. ITEM	REF.	NO.	STOWAGE LOCATION	WEIGHT	LM COORDINATES		
						X-C.G.	Y-C.G.	Z-C.G.
PENS, JATA RECORDING	A0204.	111	1	LN CREW(LH CREW STA)	.1	252.0	-22.0	44.0
PENS, JATA RECORDING	A0204.	111	1	LN CREW(RH CREW STA)	.1	252.0	22.0	38.0
PEN, MARKER	A0205.	111	1	LN CREW(LH CREW STA)	NEGL	252.0	-22.0	44.0
PEN, MARKER	A0205.	111	1	LN CREW(RH CREW STA)	NEGL	252.0	22.0	38.0
PENCIL	A0206.	111	1	LN CREW(LH CREW STA)	.1	252.0	-22.0	44.0
PENCIL	A0206.	111	1	LN CREW(RH CREW STA)	.1	252.0	22.0	38.0
GARMENT, LIQUID COOLING	B0107.	111	1	ISA (F5)	4.4	270.0	.0	52.8
GARMENT, LIQUID COOLING	B0107.	111	1	ISA (F6)	4.4	270.0	.0	52.8
SUBSYSTEM, FECAL CONTAINMENT	B0113.	111	*1	LN CREW(LH CREW STA)	.3	252.0	-22.0	44.0
SUBSYSTEM, FECAL CONTAINMENT	B0113.	111	*1	LN CREW(RH CREW STA)	.3	252.0	22.0	38.0
HARNESS, CWG ELECTRICAL (CUR)	B0135.	111	1	FIE	.4	237.9	-33.6	55.0
HARNESS, CWG ELECTRICAL (LMP)	B0135.	111	1	FIE	.4	237.9	-33.6	55.0
SCISSORS	B0204.	111	1	LN CREW(RH CREW STA)	.5	252.0	22.0	38.0
UCTA	B0205.	111	1	LN PGA-LMP (LN CREW)	.5	252.0	22.0	38.0
UCTA	B0205.	111	1	LN PGA-COM (LN CREW)	.5	252.0	-22.0	44.0
PENLIGHTS	B0206.	111	1	LN CREW(LH CREW STA)	.3	252.0	-22.0	44.0
PENLIGHTS	B0206.	111	1	LN CREW(RH CREW STA)	.3	252.0	22.0	38.0
BIURELT ASSY	B0207.	111	1	LN CREW(LH CREW STA)	.2	252.0	-22.0	44.0
BIURELT ASSY	B0207.	111	1	LN CREW(RH CREW STA)	.2	252.0	22.0	38.0
GARMENT, CONSTANT WEAR	B0208.	111	1	LN CREW(LH CREW STA)	.8	252.0	-22.0	44.0
GARMENT, CONSTANT WEAR	B0208.	111	1	LN CREW(RH CREW STA)	.8	252.0	22.0	38.0
EARPLUGS	B0210.	111	1	LN CREW(LH CREW STA)	NEGL	252.0	22.0	38.0
EARPLUGS	B0210.	111	1	LN CREW(RH CREW STA)	NEGL	252.0	-22.0	44.0
ITLSA - EV	B0211.	111	1	LN CREW(LH CREW STA)	46.9	252.0	-22.0	44.0
ITLSA - EV	B0211.	111	1	LN CREW(RH CREW STA)	46.9	252.0	22.0	38.0
GLOVES, IV PAIR	B0213.	111	1	LN CREW(RH CREW STA)	2.0	252.0	22.0	38.0
GLOVES, IV PAIR	B0213.	111	1	LN CREW(LH CREW STA)	2.0	252.0	-22.0	44.0
HELMET ASSY, PRESSURE	B0214.	111	1	LN CREW(RH CREW STA)	2.7	252.0	22.0	38.0
HELMET ASSY, PRESSURE	B0214.	111	1	LN CREW(LH CREW STA)	2.7	252.0	-22.0	44.0
HARNESS, ELEC - SUIT	B0224.	111	1	LN CREW(RH CREW STA)	.4	252.0	22.0	38.0
HARNESS, ELEC - SUIT	B0224.	111	1	LN CREW(LH CREW STA)	.4	252.0	-22.0	44.0
HARNESS, BIUISTRUMENTATION	B0216.	111	1	LN CREW(RH CREW STA)	.2	252.0	22.0	38.0

3.2-50

SNA-8-D-027(111) REV 3

TABLE 3.2-9.2 (CONTINUED)

Amendment 114
9/15/71

MISSION J-2 TRANSFERRED CREW AND EQUIPMENT STORAGE LIST								
ITEMS TRANSFERRED FROM CM INTO LM AT LM ACTIVATION (6)								
LM COORDINATES								
DESCRIPTION	STOW. ITEM	REF	NO.	STORAGE LOCATION	WEIGHT	X-C.G.	Y-C.G.	Z-C.G.
HARNESSES, BIC INSTRUMENTATION	B0216.	111	1	24 CREW (LH CREW STA)	.2	252.0	-22.0	44.0
COMMUNICATION CARRIER	B0217.	111	1	24 CREW (LH CREW STA)	1.6	252.0	22.0	38.0
COMMUNICATION CARRIER	B0217.	111	1	24 CREW (RH CREW STA)	1.6	252.0	-22.0	44.0
POCKET, SCISSORS (COM)	B0216.	111	1	24 CREW (LH CREW STA)	.2	252.0	-22.0	44.0
POCKET, SCISSORS (LMP)	B0216.	111	1	24 CREW (RH CREW STA)	.2	252.0	22.0	38.0
POCKET, CHECKLIST (COM)	B0219.	111	1	24 CREW (LH CREW STA)	.2	252.0	-22.0	44.0
POCKET, CHECKLIST (LMP)	B0219.	111	1	24 CREW (RH CREW STA)	.2	252.0	22.0	38.0
POCKET, DATA (COM)	B0220.	111	1	24 CREW (LH CREW STA)	.2	252.0	-22.0	44.0
POCKET, DATA (LMP)	B0220.	111	1	24 CREW (RH CREW STA)	.2	252.0	22.0	38.0
CAP, ELECTRICAL CONNECTOR	B0138.	111	1	24 CREW (RH CREW STA)	NEGL	252.0	22.0	38.0
CAP, ELECTRICAL CONNECTOR	B0138.	111	1	24 CREW (LH CREW STA)	NEGL	252.0	-22.0	44.0
CAP, PROTECTIVE-CWG BIO HARNES	C0112.35	111	1	24 CREW (RH CREW STA)	NEGL	252.0	22.0	38.0
CAP, PROTECTIVE-CWG BIO HARNES	C0112.35	111	1	24 CREW (LH CREW STA)	NEGL	252.0	-22.0	44.0
ASSY, BIC INSTRUMENTATION	C0201.	111	1	24 CREW (LH CREW STA)	1.1	252.0	-22.0	44.0
ASSY, BIC INSTRUMENTATION	C0201.	111	1	24 CREW (RH CREW STA)	1.1	252.0	22.0	38.0
DOSIMETER, PERSONAL	D0200.	117	1	24 CREW (RH CREW STA)	.4	252.0	22.0	38.0
DOSIMETER, PERSONAL	D0200.	117	1	24 CREW (LH CREW STA)	.4	252.0	-22.0	44.0
DOSIMETER, PASSIVE	D0201.	117	3	24 CREW (RH CREW STA)	NEGL	252.0	22.0	38.0
DOSIMETER, PASSIVE	D0201.	117	3	24 CREW (LH CREW STA)	NEGL	252.0	-22.0	44.0
HEADSET, LIGHTWEIGHT	E0112.	111	1	F1B	.4	235.5	-35.5	38.5
HEADSET, LIGHTWEIGHT	F0113.	111	1	F1B	.4	235.5	-35.5	38.5
EARPIECE, MOLDED (COMM. CARRIER)	E0200.1	111	1	24 CREW (RH CREW STA)	NEGL	252.0	22.0	38.0
EARPIECE, MOLDED (COMM. CARRIER)	F0200.1	111	1	24 CREW (LH CREW STA)	NEGL	252.0	-22.0	44.0
EARTUBE (COMM. CARRIER)	E0200.2	111	2	24 CREW (RH CREW STA)	NEGL	252.0	22.0	38.0
EARTUBE (COMM. CARRIER)	F0200.2	111	2	24 CREW (LH CREW STA)	NEGL	252.0	-22.0	44.0
BAG, 70MM MAGAZINE AFR	06466.	111	1	CONTAINER A14A	.3	243.7	-5.5	-14.8
BAG, 70MM MAGAZINE AFR	06466.	111	1	CONTAINER A14A	.3	243.7	-5.5	-14.8
UTILITY STRAP	U0315.	111	3	F1J	.1	229.5	-35.5	35.0
INFLIGHT RETAINER STRAPS	U0360.	111	4	F1J	NEGL	229.5	-35.5	35.0
2 CREW EQUIP, CM-L4					445.02	252.00	.78	40.36

3.2-51

SMA-8-D-027(III) REV 3

TABLE 3.2-9.2 (CONTINUED)

Amendment 114
9/15/71

MISSION J-2 TRANSFERRED CREW AND EQUIPMENT STORAGE LIST								
ITEMS TRANSFERRED FROM LM INTO CM AT LM ACTIVATION (7)								
DESCRIPTION	STOW. ITEM	REF	NO.	STORAGE LOCATION	WEIGHT	LM COORDINATES		
						X-C.G.	Y-C.G.	Z-C.G.
CSM/LM UMBILICAL	T8D	222	1	IN LM TUNNEL	1.1	300.0	.0	.0
EQUIP. XFR. LM-CM 1					1.10	300.00	.00	.00

3.2-52

SMA-8-D-027(III) REV 3

TABLE 3.2-9.2 (CONTINUED)

Amendment 114
9/15/71

MISSION J-2 TRANSFERRED CREW AND EQUIPMENT STORAGE LIST								
ITEMS TRANSFERRED FROM LM INTO CM AT LM ACTIVATION (8)								
DESCRIPTION	STOW. ITEM	REF	NO.	STORAGE LOCATION	WEIGHT	APULLO COORDINATES		
						X-C.G.	Y-C.G.	Z-C.G.
CSM/LM UMBILICAL	TBD	222	1	UNDER RT DOOR	1.1	1018.0	24.5	-15.0
EQUIP. XFR. LM-CM 1					1.10	1018.00	24.50	-15.00

3.2-53

SMA-8-D-027(III) REV 3

TABLE 3.2-9.2 (CONTINUED)

Amendment 114
9/15/71

MISSION J-2 TRANSFERRED CREW AND EQUIPMENT STORAGE LIST								
ITEMS REARRANGED IN LM PRIOR TO LM ACTIVATION (9)								
DESCRIPTION	STOW. ITEM	REF	QTY.	STORAGE LOCATION	WEIGHT	LM COORDINATES		
						X-C.G.	Y-C.G.	Z-C.G.
INTERIM STORAGE ASSY.	03007.	111	* 1	F6	6.4	270.0	.0	52.8
BAG, TRANSFER-16MM MAG. (2)	06432.	111	*1	ISA (F6)	.1	270.0	.0	52.8
MAGAZINE, 16MM DATA ACQ.	A0101.1	116	2	ISA (F6)	2.0	270.0	.0	52.8
BRACKET, WEDGE, 16MM CAMERA	A1041.	115	1	F7A	1.3	238.0	39.0	49.8
TETHER, EVA RETRACTABLE	A1044.	111	1	ISA (F6)	.7	270.0	.0	52.8
GARMENT, LIQUID COOLING	B0107.	111	1	ISA (F6)	4.4	270.0	.0	52.8
GARMENT, LIQUID COOLING	B0107.	111	1	ISA (F6)	4.4	270.0	.0	52.8
CAP, PROTECTIVE-CWG BIO HARNESS	C0112.35	111	1	JN CREW (RH CREW STA)	NEGL	252.0	22.0	38.0
CAP, PROTECTIVE-CWG BIO HARNESS	C0112.35	111	1	JN CREW (LH CREW STA)	NEGL	252.0	-22.0	44.0
HARNESS, WAIST (ADJ.)	B1022.	115	1	ISA (F6)	.3	270.0	.0	52.8
DEVICE, IN-SUIT DRINKING	B1048.	111	1	ISA (F6)	.3	270.0	.0	52.8
DEVICE, IN-SUIT DRINKING	B1048.	111	1	ISA (F6)	.3	270.0	.0	52.8
BRUSH, LENS	A1042.	111	1	ISA (F6)	.1	270.0	.0	52.8
UTILITY LIGHTS W/CORD	03006.	111	1	ISA (F6)	1.4	270.0	.0	52.8
UTILITY LIGHTS W/CORD	03006.	111	1	ISA (F6)	1.4	270.0	.0	52.8
BAG, TEMPORARY STORAGE	03031.	111	1	ISA (F6)	.9	270.0	.0	52.8
LM EQUIP. RELOC. 1					24.00	268.27	2.06	52.64

3.2-54

SM-8-D-027(III) REV 3

U
S
N
A
S
P
A
C
E
A
D
M
I
N
I
S
T
R
A
T
I
O
N

Amendment 114
9/15/71

TABLE 3.2-9.2 (CONTINUED)

MISSION J-2 TRANSFERRED CREW AND EQUIPMENT STORAGE LIST								
ITEMS OFFLOADED FROM ASC. STAGE PRIOR TO LUNAR LIFT-OFF (11)								
						LM COORDINATES		
DESCRIPTION	STOW. ITEM	REF	NO.	STORAGE LOCATION	WEIGHT	X-C.G.	Y-C.G.	Z-C.G.
ARM RESTS	TBD	346	3	CREW STATION	3.3	251.4	3.5	56.3
ARM RESTS	TBD	346	1	CREW STATION	1.1	251.4	-10.3	56.8
CAMERA, HASSELBLAD-ELEC DATA	A1015.	111	1	F7C	3.1	242.8	38.0	41.0
LENS, 60MM	A1016.	111	1	ON CAMERA (F7C)	1.7	242.8	38.0	41.0
PROTECTIVE COVER, RESEAU	A1023.	115	1	ON CAMERA (F7C)	.2	242.8	38.0	41.0
TRIGGER, ELECT. HASSELBLAD	A1027.	115	1	ON CAMERA (F7C)	.2	242.8	38.0	41.0
HANDLE, ELECT. HASSELBLAD	A1028.	115	1	ON CAMERA (F7C)	.5	242.8	38.0	41.0
TETHER, EVA RETRACTABLE	A1029.	115	1	A18	.2	263.5	-20.6	14.9
TETHER, EVA RETRACTABLE	A1044.	111	1	ISA(ON A3)	.7	280.0	.0	-10.0
MAGAZINE, 70MM LUNAR SURFACE	A0108.1	111	3	IN XFR BAG(F7D)	4.2	238.0	38.0	38.4
MAGAZINE, 70MM LUNAR SURFACE	A0108.1	111	1	ON CAMERA (F7C)	1.4	242.8	38.0	41.0
MAGAZINE, 70MM LUNAR SURFACE	A0108.1	111	2	A14A	2.8	243.7	-5.5	-14.8
MAGAZINE, 70MM LUNAR SURFACE	A0108.1	111	3	F7P	4.2	241.0	38.0	53.4
MAGAZINE, 70MM LUNAR SURFACE	A0108.1	111	2	A14A	2.8	243.7	-5.5	-14.8
MAGAZINE, 70MM LUNAR SURFACE	A0108.1	111	1	A14A	1.4	243.7	-5.5	-14.8
MAGAZINE, 16MM D4C	A0101.1	111	5	F7L	5.0	231.8	36.0	47.3
MAGAZINE, 16MM D4C	A0101.1	111	2	ISA(ON A3)	2.0	280.0	.0	-10.0
MAGAZINE, 16MM D4C	A0101.1	111	1	F5	1.0	286.0	17.8	66.6
GARMENT, LIQUID COOLING	B0107.	111	1	ISA(ON A3)	4.4	280.0	.0	-10.0
GARMENT, LIQUID COOLING	B0107.	111	1	ISA(ON A3)	4.4	280.0	.0	-10.0
GARMENT, CONSTANT WEAR	B0208.	111	1	ON CREW(LH CREW STA)	.8	252.0	-22.0	44.0
GARMENT, CONSTANT WEAR	B0208.	111	1	ON CREW(RH CREW STA)	.8	252.0	22.0	38.0
EARPLUGS	B0210.	111	1	ON CREW(LH CREW STA)	NEGL	252.0	22.0	38.0
EARPLUGS	B0210.	111	1	ON CREW(RH CREW STA)	NEGL	252.0	-22.0	44.0
REMOTE CONTROL UNIT-PLSS	B1001.	115	2	A12	10.2	272.0	.0	-18.0
BRACKET, CAMERA MOUNT	B1001.1	115	1	F7F	.5	238.0	38.0	31.6
ADAPTER ASSY, 20 DSN 70MM HASS	R1004.	111	2	F7C	.2	242.8	38.0	41.0
BAG, JETTISON STORAGE	H1027.	111	1	A18	.9	257.5	-20.0	-18.0
UTILITY TOWEL ASSEMBLY, LM	H1008.	115	2	F1D	.6	242.8	-35.4	47.2
DEFECATION COLLECTION DEVICE	H1009.	115	3	F1F	.6	235.5	-37.6	45.6

3.2-56

SNA-8-D-027(III) REV 3

TABLE 3.2-9.2 (CONTINUED)

Amendment 114
9/15/71

MISSION J-2 TRANSFERRED CREW AND EQUIPMENT STORAGE LIST								
ITEMS UNLOADED FROM ASC. STAGE PRIOR TO LUNAR LIFT-OFF (III)								
DESCRIPTION	STOW. ITEM	REF	QTY.	STORAGE LOCATION	LM COORDINATES			
					W/FIGHT	X-C.G.	Y-C.G.	Z-C.G.
URINE BAGS	U3009.	111	1	F1F	.3	235.5	-37.6	46.6
JUCTS, LUNAR PAIR	B1018.	115	1	A1L	4.5	281.0	-20.0	-8.5
BOOTS, LUNAR PAIR	B1018.	115	1	A1K	4.5	273.7	-20.0	-8.5
BAG ASSY, LEC + W.T.	B1020.1	115	1	F7N	.2	238.0	38.0	53.1
CONVEYOR ASSY, LUNAR EQUIP.	B1020.2	115	1	F7N	1.3	236.0	38.0	53.1
BAG, DEPLOYMENT, LEC	B1020.3	115	1	F7N	.1	238.0	38.0	53.1
BAG, HELMET+LEVA INTERIM	B1057.	111	1	F7	1.4	219.7	.0	44.7
PLSS	B1024.	111	1	A1H	88.8	263.5	-20.6	14.9
PLSS	B1025.	111	1	F7	88.7	219.7	.0	44.7
BAG, JETTISON STORAGE	B1027.	115	3	A1G	2.7	257.5	-20.0	-18.0
DISPENSER, TISSUE	B1033.	116	1	F1F	1.4	237.0	-33.6	55.0
ADAPTER, LIQUID COOL. GARMENT	B1036.	116	2	F7E	.4	243.2	38.0	31.2
JACKET ASSY, ICG	B1039.1	116	1	A1C (ICG ASSY)	3.6	240.5	-15.3	13.3
TROUSER ASSY, ICG	B1039.2	116	1	A1C (ICG ASSY)	3.6	240.5	-15.3	13.3
BOOT, RIGHT, ICG	B1039.3	116	2	A1C (ICG ASSY)	.8	240.5	-15.3	13.3
BOOT, LEFT, ICG	B1039.4	116	2	A1C (ICG ASSY)	.8	240.5	-15.3	13.3
TOWELS, LM UTILITY (RED)	B1043.	115	2	F1G	.2	228.0	-40.2	43.2
TOWELS, LM UTILITY (BLUE)	B1044.	115	2	F1G	.2	228.0	-40.2	43.2
SLEEP RESTRAINT ASSY	B1061.	111	2	F7	5.0	219.7	.0	44.7
CONTAINER, BUDDY SLESS ASSY	U3059.	111	1	A5	3.0	221.8	-1.0	29.5
BUDDY SLESS ASSY	B1052.	116	1	A5	7.3	221.8	-1.0	29.5
TOOL CARRIER, PLSS (GDK)	B1063.	111	1	A5	1.2	221.8	-1.0	29.5
TOOL CARRIER, PLSS (LMP)	B1064.	111	1	A5	2.5	221.8	-1.0	29.5
FOOD ASSY, LM	C1002.	165	1	A7	3.3	288.0	.0	-24.0
WIPES, WET, FACIAL	C1005.	115	5	F1A	NEG.	244.5	-36.6	31.4
CONTR. CONTING. ENLY, LUN. SAM. RTN	G4015.	115	1	A15	.8	257.5	-20.0	-18.0
ADAPTER, SRC/OPS	U3004.	115	1	A1C	3.5	265.9	-20.7	-6.0
ADAPTER, SRC/OPS	C3004.	115	1	A1F	3.5	257.4	-20.7	-6.0
CANISTER, EGCS LITH	U3008.	115	1	A1D	9.1	250.0	8.0	-11.8
BAG, RESIST	U3011.	115	3	F1F	.6	235.5	-37.6	46.6

3.2-57

SNA-8-D-027(III) REV 3

TABLE 3.2-9.2 (CONTINUED)

Amendment 114
9/15/71

MISSION J-2 TRANSFERRED CREW AND EQUIPMENT STORAGE LIST								
ITEMS OFFLOADED FROM ASC. STAGE PRIOR TO LUNAR LIFT-OFF (11)								
DESCRIPTION	STOW. ITEM	REF	NO.	STORAGE LOCATION	WEIGHT	LM COORDINATES		
						X-C.G.	Y-C.G.	Z-C.G.
STRAP, ECS LIQUID CANNISTER	03024.	115	1	A1C	.1	250.0	8.0	-11.8
HOLDER, MAP-LRV	R1002.	111	1	A1A	.5	280.0	-19.7	13.5
URINE RECEPTACLE SYSTEM	03034.	115	1	F1C	.6	242.5	-35.6	38.5
HAMMOCK ASSY.	03048.	115	1	F1G	4.0	228.0	-47.2	43.2
HAMMOCK ASSY	03050.	115	1	F1G	3.9	228.0	-47.2	43.2
WEBBING, TIE-DOWN-CONTINGENCY	03069.	111	1	F7J	.4	231.5	35.4	41.8
STRAP ASSY, SLEEP RESTRAINT	03082.	111	2	F9	.2	219.7	.0	44.7
LEFT AT LUNAR SITE					312.20	244.91	-6.23	23.46

3.2-58

SNA-8-D-027(111) REV 3

TABLE 3.2-9.2 (CONTINUED)

Amendment 114
9/15/71

MISSION J-2 TRANSFERRED CREW AND EQUIPMENT STORAGE LIST								
ITEMS UNLOADED INTO ASC. STAGE PRIOR TO LUNAR LIFT-OFF (12)								
LM C COORDINATES								
DESCRIPTION	STOW. ITEM	REF	NO.	STORAGE LOCATION	WEIGHT	X-C.G.	Y-C.G.	Z-C.G.
BAG, J.S.H. DISPENSER	G4004.3	115	4	A1E	3.0	265.9	-20.7	-6.0
DRIVE TUBES IN BAG 5	G4004.4	115	3	A1E	1.9	265.9	-20.7	-6.0
SAMPLES IN DRIVE TUBE G4004.4	N/A	115	1	A1E	3.9	265.9	-20.7	-6.0
CAPS AND DISPENSERS	G4004.5	115	2	A1E	.2	265.9	-20.7	-6.0
ORGANIC SAMPLE	G4004.6	115	1	A1E	.2	265.9	-20.7	-6.0
SAMPLES IN BAG 5	N/A	115	1	A1E	12.9	265.9	-20.7	-6.0
BAG, SAMPLE RETURN	O3060.	111	1	DN PLUS 227 BULKHEAD	3.2	221.8	-1.0	29.5
SAMPLES IN O3060.	N/A	111	1	DN PLUS 227 BULKHEAD	31.6	221.8	-1.0	29.5
MAGAZINE, UV	G4042.	111	1	VOLUME CENTROID AS	2.0	254.0	.0	.0
SAMPLE COLLECTION BAG 4	G4056.	115	1	LOWER BAY RHSSC	1.7	238.0	38.0	42.7
BAG, SAMPLE CONTAINMENT	O3078.	115	1	LOWER BAY RHSSC	.6	238.0	38.0	42.7
SAMPLES IN BAG 4	N/A	115	1	LOWER BAY RHSSC	25.2	238.0	38.0	42.7
BAG, SAMPLE COLLECTION	O3074.	111	1	LOWER MID-SECTION	.6	240.5	-18.0	13.3
SAMPLE COLLECTION BAG 3	G4048.	111	1	LOWER MID-SECTION	1.2	240.5	-18.0	13.3
SAMPLES IN BAG 3	N/A	115	1	LOWER MID-SECTION	12.9	240.5	-18.0	13.3
DRIVE TUBES IN BAG 5	G4004.4	115	3	A1E	1.9	265.9	-20.7	-6.0
SAMPLES IN DRIVE TUBE G4004.4	N/A	115	1	A1E	3.9	265.9	-20.7	-6.0
CAPS AND DISPENSERS	G4003.7	115	1	A1E	.1	257.4	-20.7	-6.0
SAMPLE COLLECTION BAG 8	G4048.	111	1	AFT ENG CAN(A14A)	1.2	239.6	-5.5	-14.8
SAMPLES IN BAG 8	N/A	115	1	AFT ENG CAN(A14A)	12.9	239.6	-5.5	-14.8
BAG, SAMPLE CONTAINMENT	O3078.	111	1	AFT ENG CAN(A14A)	.6	239.6	-5.5	-14.8
DRIVE TUBES IN BAG 1	G4003.4	115	3	A1E	1.9	257.4	-20.7	-6.0
SAMPLES IN DRIVE TUBE G4003.4	N/A	115	1	A1E	4.0	257.4	-20.7	-6.0
UNLOAD AT LUN. SITE					279.60	240.54	-7.39	11.67

3.2-60

SMA-8-D-027(III) REV 3

TABLE 3.2-9.2 (CONTINUED)

Amendment 114
9/15/71

MISSION J-2 TRANSFERRED CREW AND EQUIPMENT STORAGE LIST								
ITEMS REARRANGED IN LM PRIOR TO LUNAR LIFT-OFF (13)								
DESCRIPTION	STOW. ITEM	REF	NO.	STORAGE LOCATION	WEIGHT	LM COORDINATES		
						X-C.G.	Y-C.G.	Z-C.G.
FLIGHT DATA FILE ASSY	A1008.	111	1	A1A	7.0	280.0	-19.0	13.5
OXYGEN PURGE SYSTEM	B1012	111	1	A1E	32.3	265.9	-20.7	-6.0
BAG, HELMET STORAGE	B1059.	115	* 1	F2	1.4	221.0	18.0	51.0
BAG, HELMET STORAGE	B1058.	115	1	F10	1.4	221.0	-18.0	51.0
LUNAR EXTRAVEHICULAR VISOR	B1019.	115	1	F10	5.6	221.0	-18.0	51.0
LUNAR EXTRAVEHICULAR VISOR	B1014.	115	1	F3	5.6	221.0	18.0	51.0
GLOVES, EV (PAIR)	B1015.	111	1	F4	2.9	221.0	18.0	51.0
GLOVES, EV (PAIR)	B1015.	111	1	F10	2.9	221.0	-18.0	51.0
KIT, EMO MAINTENANCE	B1016.	115	1	F10	.5	221.0	-18.0	51.0
PURGE VALVE ASSY.	B1017.	115	1	A1H	.6	265.9	-20.0	-18.0
PURGE VALVE ASSY.	B1017.	115	1	A1K	.6	273.7	-20.0	-9.5
HARNESS, WAIST	B1021.	115	1	F9	.2	219.7	.0	44.7
HARNESS, WAIST	B1021.	115	1	A1B	.2	263.5	-20.6	14.9
HARNESS, WAIST (ADJ.)	B1022.	115	1	F9	.3	219.7	.0	44.7
HARNESS, WAIST (ADJ.)	B1022.	115	1	A1B	.3	263.5	-20.6	14.9
GARMENT, LIQUID COOLING	B1030.	111	1	A1C	4.4	240.5	-18.0	13.3
GARMENT, LIQUID COOLING	B1030.	111	1	A1C	4.4	240.5	-18.0	13.3
DEVICE, IN-SUIT DRINKING	B1048.	111	1	ISA (ON A3)	.3	280.0	.0	-10.0
DEVICE, IN-SUIT DRINKING	B1048.	111	1	ISA (ON A3)	.3	280.0	.0	-10.0
OXYGEN PURGE SYSTEM	B1059	111	1	A1F	32.2	257.4	-20.7	-6.0
BAG, EQUIPMENT TRANSFER	U3018.	111	1	A5	.8	221.8	-1.0	29.5
EVA GUFF CHECKLIST	A1040.	111	4	F10	1.2	221.0	-18.0	51.0
BAG, 7MM MAGAZINE XFK	U6466.	111	1	CONTAINER A14A	.3	243.7	-5.5	-14.8
BAG, 7MM MAGAZINE XFK	U6466.	111	1	CONTAINER A14A	.3	243.7	-5.5	-14.8
LM EQUIP. RELOC.					136.00	252.47	-16.00	9.90

3.2-61

SNA-8-D-027(III) REV 3

U
R
N
A
L
O
F
T
E
C
H
N
O
L
O
G
Y

TABLE 3.2-9.2 (CONTINUED)

Amendment 114
9/15/71

MISSION J-2 TRANSFERRED CREW AND EQUIPMENT STORAGE LIST								
ITEMS REARRANGED IN LM PRIOR TO LUNAR LIFT-OFF (14)								
DESCRIPTION	STOW. ITEM	REF	NO.	STORAGE LOCATION	WEIGHT	LM COORDINATES		
						X-C.G.	Y-C.G.	Z-C.G.
FLIGHT DATA FILE ASSY	A1003.	111	1	ISA(LUN A3)	7.0	280.0	.0	-10.0
OXYGEN PURGE SYSTEM	B1012	111	1	F2	32.3	219.7	.0	44.7
BAG, HELMET STORAGE	B1058.	115	* 1	A3	1.4	280.0	.0	-10.0
BAG, HELMET STORAGE	B1058.	115	1	A3	1.4	280.0	.0	-10.0
LUNAR EXTRAVEHICULAR VISOR	B1014.	115	1	1X HSB(A3)	5.6	280.0	.0	-10.0
LUNAR EXTRAVEHICULAR VISOR	B1014.	115	1	1X HSB(A3)	5.6	280.0	.0	-10.0
GLOVES, EV (PAIR)	B1015.	111	1	1X HSB(A3)	2.9	280.0	.0	-10.0
GLOVES, EV (PAIR)	B1015.	111	1	1X HSB(A3)	2.9	280.0	.0	-10.0
KIT, E4U MAINTENANCE	B1016.	115	1	ISA(LUN A3)	.5	280.0	.0	-10.0
PURGE VALVE ASSY.	B1017.	115	1	FIK	.6	237.8	-37.8	31.5
PURGE VALVE ASSY.	B1017.	115	1	FIK	.6	237.8	-37.8	31.5
HARNESS, WAIST	B1021.	115	1	FIK	.2	237.8	-37.8	31.5
HARNESS, WAIST	B1021.	115	1	FIK	.2	237.8	-37.8	31.5
HARNESS, WAIST (ADJ.)	B1022.	115	1	FIK	.3	237.8	-37.8	31.5
HARNESS, WAIST (ADJ.)	B1022.	115	1	FIK	.3	237.8	-37.8	31.5
GARMENT, LIQUID COOLING	B1030.	111	1	ON CREW (RH CREW STA)	4.4	252.0	22.0	38.0
GARMENT, LIQUID COOLING	B1030.	111	1	ON CREW (RH CREW STA)	4.4	252.0	22.0	38.0
DEVICE, IN-SUIT DRINKING	B1048.	111	1	ON CREW (LH CREW STA)	.3	252.0	-22.0	44.0
DEVICE, IN-SUIT DRINKING	B1048.	111	1	ON CREW (RH CREW STA)	.3	252.0	22.0	38.0
OXYGEN PURGE SYSTEM	B1059	111	1	F2	32.2	219.7	.0	44.7
BAG, EQUIPMENT TRANSFER	U3018.	111	1	ISA(LUN A3)	.8	280.0	.0	-10.0
EVA GUFF CHECKLIST	A1040.	111	4	ISA(LUN A3)	1.2	280.0	.0	-10.0
BAG, 73MM MAGAZINE XFK	06466.	111	1	41K	.3	273.7	-27.0	-8.5
BAG, 73MM MAGAZINE XFK	06466.	111	1	41K	.3	273.7	-27.0	-8.5
LM EQUIP. RELUC.?					106.00	239.91	.93	24.43

3.2-62

SNA-8-D-027(111) REV 3

TABLE 3.2-9.2 (CONTINUED)

Amendment 114
9/15/71

MISSION J-2 TRANSFERRED CREW AND EQUIPMENT STORAGE LIST								
ITEMS TRANSFERRED FROM ASC. STAGE INTO CM PRIOR TO ASC. STAGE JETTISON (15)								
LM COORDINATES								
DESCRIPTION	STOR. ITEM	REF	NG.	STORAGE LOCATION	#FIGHT	X-C.G.	Y-C.G.	Z-C.G.
CREW-CM MANDER (CDR)	N/A	227	1	CREW STATION - LH	164.0	252.0	-27.0	44.0
CREW-LM PILOT (LMP)	N/A	227	1	CREW STATION - RH	160.5	252.0	22.0	38.0
INTERIM STORAGE ASSY.	U3007.	111	* 1	A3	6.4	260.0	.0	-10.0
BAG, SAMPLE CONTAINMENT	E3078.	111	2	ISA (CN A3)	1.2	280.0	.0	-10.0
SAMPLE COLLECTION BAG 2 AND 6	U4348.	115	2	ISA (CN A3)	2.4	280.0	.0	-10.0
SAMPLES IN BAG 2 AND 6	N/A	115	2	ISA (CN A3)	25.6	280.0	.0	-10.0
BAG, XFER, 16MM MAGAZINE	U6397.	111	1	F7J	.3	231.8	36.0	47.3
BAG, XFER, 7MM MAGAZINE	U6398.	111	1	F7J	.5	238.0	38.0	38.4
BAG, TRANSFER-16MM MAG. (2)	U6432.	111	*1	ISA (CN A3)	.1	280.0	.0	-10.0
BAG, TRANSFER-7MM MAG. (3)	U6434.	111	*1	F7P	.5	241.0	38.0	53.4
MAGAZINE, 16MM DATA ACQ.	A0101.1	116	5	IN XFER BAG (F7J)	5.0	231.8	36.0	47.3
MAGAZINE, 16MM DATA ACQ.	A0101.1	116	2	ISA (CN A3)	2.0	280.0	.0	-10.0
MAGAZINE, 16MM DATA ACQ.	A0101.1	116	1	F9	1.0	286.0	17.8	66.6
MAGAZINE, L.S. HASSELBLAU	A0108.1	116	3	IN XFER BAG (F7J)	4.2	238.0	38.0	38.4
MAGAZINE, L.S. HASSELBLAU	A0108.1	116	1	IN XFER BAG (F7J)	1.4	238.0	38.0	38.4
MAGAZINE, L.S. HASSELBLAU	A0108.1	116	3	IN XFER BAG (F7J)	4.2	241.0	38.0	53.4
DOSEMETER, PASSIVE RADIATION	D0101.	111	1	IN XFER BAG (F7J)	NEGL	231.8	36.0	47.3
LM XFER DATA CARD KIT	A0114.18	114	1	A1A	.6	280.0	-19.0	13.5
LM LUNAR SURFACE CHECKLIST	A0114.18	114	1	LM XFER DATA CARD KIT	1.0	280.0	-19.0	13.5
LM SYSTEMS ACTIVATION CHK. LST.	A0114.12	114	1	LM XFER DATA CARD KIT	.5	280.0	-19.0	13.5
LM SYSTEMS ACTIVATION CHK. LST.	A0114.12	114	1	LM XFER DATA CARD KIT	.5	280.0	-19.0	13.5
LM LUNAR SURFACE MAPS	A0114.13	114	1	L4 XFER DATA CARD KIT	1.5	280.0	-19.0	13.5
LM TIMELINE BOOK	A0114.14	114	1	LM XFER DATA CARD KIT	.5	280.0	-19.0	13.5
LM DATA CARD BOOK	A0114.19	114	1	LM XFER DATA CARD KIT	.3	280.0	-19.0	13.5
LM RNOZ/ABORT BOOK	A0114.22	114	1	LM XFER DATA CARD KIT	.3	280.0	-19.0	13.5
MUNOCULAR 10X40	A0130.	116	1	F7A	.7	238.4	38.6	46.0
SUNGLASSES	A0200.	111	1	ON CREW (LH CREW STA)	.1	252.0	-27.0	44.0
SUNGLASSES	A0200.	111	1	ON CREW (RH CREW STA)	.1	252.0	22.0	38.0
POUCH, SUNGLASSES	A0201.	111	1	ON CREW (LH CREW STA)	NEGL	252.0	-27.0	44.0
POUCH, SUNGLASSES	A0201.	111	1	ON CREW (RH CREW STA)	NEGL	252.0	22.0	38.0

3.2-63

SMA-8-D-027(III) REV 3

TABLE 3.2-9.2 (CONTINUED)

Amendment 114
9/15/71

MISSION J-2 TRANSPREPARED CREW AND EQUIPMENT STOWAGE LIST								
ITEMS TRANSFERRED FROM ASC. STAGE INTO CM PRIOR TO ASC. STAGE JETTISON (15)								
LM COORDINATES								
DESCRIPTION	STOW. ITEM	REF	NU.	STORAGE LOCATION	WEIGHT	X-C.G.	Y-C.G.	Z-C.G.
CHRONOGRAPH - CL2	A0202.	111	1	ON CREW(LH CREW STA)	.1	252.0	-22.0	44.0
CHRONOGRAPH - CL2	A0202.	111	1	ON CREW(RH CREW STA)	.1	252.0	22.0	38.0
WATCHBAND	A0203.	111	1	ON CREW(LH CREW STA)	NEGL	252.0	-22.0	44.0
WATCHBAND	A0203.	111	1	ON CREW(RH CREW STA)	NEGL	252.0	22.0	38.0
PENS, DATA RECORDING	A0204.	111	1	ON CREW(LH CREW STA)	.1	252.0	-22.0	44.0
PENS, DATA RECORDING	A0204.	111	1	ON CREW(RH CREW STA)	.1	252.0	22.0	38.0
PEN, MARKER	A0205.	111	1	ON CREW(LH CREW STA)	NEGL	252.0	-22.0	44.0
PEN, MARKER	A0205.	111	1	ON CREW(RH CREW STA)	NEGL	252.0	22.0	38.0
PENCIL	A0206.	111	1	ON CREW(LH CREW STA)	.1	252.0	-22.0	44.0
PENCIL	A0206.	111	1	ON CREW(RH CREW STA)	.1	252.0	22.0	38.0
KIT, PILOTS PREFERENCE	A1007.	111	2	AIR	1.8	265.9	-20.0	-18.0
KIT, PILOTS PREFERENCE	A1007.	111	1	AIR	.9	265.9	-20.0	-18.0
MAGAZINE, 7MM LUNAR SURFACE	A0108.1	111	3	AIR	4.2	273.7	-20.0	-8.5
MAGAZINE, 7MM LUNAR SURFACE	A0108.1	111	2	AIR	2.8	273.7	-20.0	-8.5
SUBSYSTEM, FECAL CONTAINMENT	B0113.	111	*1	ON CREW(LH CREW STA)	.3	252.0	-22.0	44.0
SUBSYSTEM, FECAL CONTAINMENT	B0113.	111	*1	ON CREW(RH CREW STA)	.3	252.0	22.0	38.0
HARNESS, CWG ELECTRICAL (CDR)	B0135.	111	1	FILE	.4	237.9	-33.6	55.0
HARNESS, CWG ELECTRICAL (LMP)	B0135.	111	1	FILE	.4	237.9	-33.6	55.0
SCISSORS	B0204.	111	1	ON CREW(RH CREW STA)	.5	252.0	22.0	38.0
UCTA	B0205.	111	1	ON CREW(RH CREW STA)	.5	252.0	22.0	38.0
UCTA	B0205.	111	1	ON CREW(LH CREW STA)	.5	252.0	-22.0	44.0
PENLIGHTS	B0206.	111	1	ON CREW(LH CREW STA)	.3	252.0	-22.0	44.0
PENLIGHTS	B0206.	111	1	ON CREW(RH CREW STA)	.3	252.0	22.0	38.0
BIOBELT ASSY	B0207.	111	1	ON CREW(LH CREW STA)	.2	252.0	-22.0	44.0
BIOBELT ASSY	B0207.	111	1	ON CREW(RH CREW STA)	.2	252.0	22.0	38.0
ITLSA - EV	B0211.	111	1	ON CREW(RH CREW STA)	46.9	252.0	22.0	38.0
ITLSA - EV	B0211.	111	1	ON CREW(LH CREW STA)	46.9	252.0	-22.0	44.0
GLOVES, IV PAIR	B0213.	111	1	ON CREW(RH CREW STA)	2.0	252.0	22.0	38.0
GLOVES, IV PAIR	B0213.	111	1	ON CREW(LH CREW STA)	2.0	252.0	-22.0	44.0
HELMET ASSY, PRESSURE	B0214.	111	1	ON CREW(RH CREW STA)	2.7	252.0	22.0	38.0

3.2-64

SMA-8-D-027(III) REV 3

TABLE 3.2-9.2 (CONTINUED)

Amendment 114
9/15/71

MISSION J-2 TRANSFERRED CREW AND EQUIPMENT STORAGE LIST								
ITEMS TRANSFERRED FROM ASC. STAGE INTO OR FROM TO ASC. STAGE JETTISON (15)								
LM COORDINATES								
DESCRIPTION	STOW. ITEM	REF	NO.	STOWAGE LOCATION	WEIGHT	X-C.G.	Y-C.G.	Z-C.G.
HELMET ASSY, PRESSURE	B0214.	111	1	ON CREW(LH CREW STA)	2.7	252.0	-22.0	44.0
HARNES, ELEC - SUIT	B0224.	111	1	ON CREW(LH CREW STA)	.4	252.0	22.0	38.0
HARNES, ELEC - SUIT	B0224.	111	1	ON CREW(LH CREW STA)	.4	252.0	-22.0	44.0
HARNES, BIOMINSTRUMENTATION	B0216.	111	1	ON CREW(LH CREW STA)	.2	252.0	22.0	38.0
HARNES, BIOMINSTRUMENTATION	B0216.	111	1	ON CREW(LH CREW STA)	.2	252.0	-22.0	44.0
COMMUNICATION CARRIER	B0217.	111	1	ON CREW(LH CREW STA)	1.6	252.0	22.0	38.0
COMMUNICATION CARRIER	B0217.	111	1	ON CREW(LH CREW STA)	1.6	252.0	-22.0	44.0
POCKET, SCISSORS (COK)	B0218.	111	1	ON CREW(LH CREW STA)	.2	252.0	-22.0	44.0
POCKET, SCISSORS (LMP)	B0218.	111	1	ON CREW(LH CREW STA)	.2	252.0	22.0	38.0
POCKET, CHECKLIST (COK)	B0219.	111	1	ON CREW(LH CREW STA)	.2	252.0	-22.0	44.0
POCKET, CHECKLIST (LMP)	B0219.	111	1	ON CREW(LH CREW STA)	.2	252.0	22.0	38.0
POCKET, DATA (COK)	B0220.	111	1	ON CREW(LH CREW STA)	.2	252.0	-22.0	44.0
POCKET, DATA (LMP)	B0220.	111	1	ON CREW(LH CREW STA)	.2	252.0	22.0	38.0
CAP, ELECTRICAL CONNECTOR	B0138.	111	1	ON CREW(LH CREW STA)	NEGL	252.0	22.0	38.0
CAP, ELECTRICAL CONNECTOR	B0138.	111	1	ON CREW(LH CREW STA)	NEGL	252.0	-22.0	44.0
CAP, PROTECTIVE-CWG BID HARNES	C0112.35	111	1	ISA(ON A3)	NEGL	280.0	.0	-10.0
CAP, PROTECTIVE-CWG BID HARNES	C0112.35	111	1	ISA(ON A3)	NEGL	280.0	.0	-10.0
BAG, JETTISON STOWAGE	B1027.	111	1	ISA(ON A3)	.9	280.0	.0	-10.0
FLIGHT DATA FILE ASSY	A1078.	111	1	ISA(ON A3)	7.0	280.0	.0	-10.0
DUST COVER, NECK RING	B1065.	111	2	F7F	.2	243.2	38.0	31.2
BAG, COSMIC RAY PACKAGE	B3047.	111	1	A1C	.7	240.5	-18.0	13.3
DETECTOR ARRAY ASSY	G4021.1	111	1	A1C	8.0	240.5	-18.0	13.3
OXYGEN PURGE SYSTEM	B1012	111	1	F7	32.3	219.7	.0	44.7
BAG, HELMET STOWAGE	B1054.	115	* 1	A3	1.4	280.0	.0	-10.0
BAG, HELMET STOWAGE	B1058.	115	1	A3	1.4	280.0	.0	-10.0
LUNAR EXTRAVENICULAR VISOR	B1014.	115	1	IN HSB(A3)	5.6	280.0	.0	-10.0
LUNAR EXTRAVENICULAR VISOR	B1014.	115	1	IN HSB(A3)	5.6	280.0	.0	-10.0
GLOVES, EV (PAIR)	B1015.	111	1	IN HSB(A3)	2.9	280.0	.0	-10.0
GLOVES, EV (PAIR)	B1015.	111	1	IN HSB(A3)	2.9	280.0	.0	-10.0
KIT, EAU MAINTENANCE	B1016.	115	1	ISA(ON A3)	.5	280.0	.0	-10.0

3.2-65

SNA-B-D-027(III) REV 3

U
N
I
T
E
D
S
T
A
T
E
S
O
F
A
M
E
R
I
C
A

Amendment 114
9/15/71

TABLE 3.2-9.2 (CONTINUED)

MISSION J-2 TRANSFERRED CREW AND EQUIPMENT STORAGE LIST								
ITEMS TRANSFERRED FROM ASC. STAGE INTO OR PRIOR TO ASC. STAGE JETTISON (15)								
DESCRIPTION	STOW. ITEM	REF	NO.	STORAGE LOCATION	WEIGHT	LM COORDINATES		
						X-C.O.	Y-C.O.	Z-C.O.
PURGE VALVE ASSY.	F1017.	115	1	F1A	.6	237.6	-37.8	31.5
TETHER, WAIST EVA	F1020.6	115	1	F7A	.6	238.0	38.0	53.1
TETHER, WAIST EVA	F1020.7	115	1	F7A	.6	238.0	38.0	53.1
GARMENT, LIQUID COOLING	B1030.	111	1	DN CREW(RH CREW STA)	4.4	252.0	22.0	38.0
GARMENT, LIQUID COOLING	B1030.	111	1	DN CREW(LH CREW STA)	4.4	252.0	22.0	38.0
DEVICE, IN-SUIT DRINKING	F1048.	111	1	DN CREW(LH CREW STA)	.3	252.0	-22.0	44.0
DEVICE, IN-SUIT DRINKING	B1048.	111	1	DN CREW(LH CREW STA)	.3	252.0	22.0	38.0
ASSY, JIG INSTRUMENTATION	C0201.	111	1	DN CREW(LH CREW STA)	1.1	252.0	-22.0	44.0
ASSY, JIG INSTRUMENTATION	C0201.	111	1	DN CREW(RH CREW STA)	1.1	252.0	22.0	38.0
DOSIMETER, PERSONAL	D0200.	117	1	DN CREW(LH CREW STA)	.4	252.0	22.0	38.0
DOSIMETER, PERSONAL	D0200.	117	1	DN CREW(LH CREW STA)	.4	252.0	-22.0	44.0
DOSIMETER, PASSIVE	D0201.	117	3	DN CREW(RH CREW STA)	NEGL	252.0	22.0	38.0
DOSIMETER, PASSIVE	D0201.	117	3	DN CREW(LH CREW STA)	NEGL	252.0	-22.0	44.0
HEADSET, LIGHTWEIGHT	E0111.	111	1	F1A	.4	235.5	-35.5	38.5
HEADSET, LIGHTWEIGHT	E0112.	111	1	F1A	.4	235.5	-35.5	38.5
EARPIECE, MOLDED (COMM. CARRIER)	E0200.1	111	1	DN CREW(RH CREW STA)	NEGL	252.0	22.0	38.0
EARPIECE, MOLDED (COMM. CARRIER)	E0200.1	111	1	DN CREW(LH CREW STA)	NEGL	252.0	-22.0	44.0
EARTUBE (COMM. CARRIER)	E0200.2	111	2	DN CREW(RH CREW STA)	NEGL	252.0	22.0	38.0
EARTUBE (COMM. CARRIER)	E0200.2	111	2	DN CREW(LH CREW STA)	NEGL	252.0	-22.0	44.0
CONTR. CONTINGENCY, LUN. SAM. RTN	G4016.	115	1	ISA (ON A3)	2.7	280.0	.0	-10.0
BRUSH, LENS	A1042.	111	1	ISA (ON A3)	.1	280.0	.0	-10.0
FLAG KIT, STANDARD	N1002.	166	1	A1A	.8	265.9	-20.0	-18.0
DSEA	B3005.	115	1	A2	2.3	260.0	-37.0	28.0
BAG, EQUIPMENT TRANSFER	C0018.	111	1	ISA (ON A3)	.8	280.0	.0	-10.0
BAG, TEMPORARY STORAGE	C0031.	111	1	ISA (ON A3)	.9	280.0	.0	-10.0
UPPER HOUSING ASSY, PENE. TROMETR	C4049.1	111	1	A1L	2.0	281.0	-20.0	-8.5
SAMPLE COLLECTION BAG 7	C4056.	111	1	LOWER BAY LHSSC	1.7	228.0	-40.2	43.2
BAG, SAMPLE CONTAINMENT	C4078.	111	1	LOWER BAY LHSSC	.6	228.0	-40.2	43.2
SAMPLES IN BAG 7	N/A	115	1	LOWER BAY LHSSC	25.1	228.0	-40.2	43.2
CONTAINER, SKC NO. 1	G4003.	115	1	A1F	14.1	257.4	-20.7	-6.0

3.2-66

SNA-B-D-027(111) REV 3

U
N
I
T
E
D
S
T
A
T
E
S
O
F
A
M
E
R
I
C
A

TABLE 3.2-9.2 (CONTINUED)

Amendment 114
9/15/71

MISSION J-2 TRANSFERRED CREW AND EQUIPMENT STORAGE LIST									
ITEMS TRANSFERRED FROM ASC. STAGE INTO CAPRI TO ASC. STAGE JETTISON (15)									
LM COORDINATES									
DESCRIPTION	STOW. ITEM	REF	NO.	STORAGE LOCATION	WEIGHT	X-C.G.	Y-C.G.	Z-C.G.	
SAMPLE COLLECTION BAG 1	G4003.1	115	1	A1F	1.7	257.4	-20.7	-6.0	
S.E.S. CONTAINER	G4003.2	115	1	A1F	.7	257.4	-20.7	-6.0	
BAG, D.S.B. DISPENSER	G4003.3	115	2	A1F	1.5	257.4	-20.7	-6.0	
DRILL STEMS IN BAG 1	G4003.6	115	6	A1F	2.6	257.4	-20.7	-6.0	
SAMPLES IN DRILL STEM G4003.6	N/A	115	1	A1F	3.0	257.4	-20.7	-6.0	
CAPS AND DISPENSERS	G4003.5	115	1	A1F	.2	257.4	-20.7	-6.0	
ORGANIC SAMPLES	G4003.8	115	1	A1F	.2	257.4	-20.7	-6.0	
SAMPLES IN BAG 1	N/A	115	1	A1F	15.1	257.4	-20.7	-6.0	
EVA CUFF CHECKLIST	A1C40.	111	4	ISA TOR. 431	1.2	280.0	.0	-10.0	
CONTAINER, SRC NO.2	G4004.	115	1	A1E	13.9	265.9	-20.7	-6.0	
SAMPLE COLLECTION BAG 5	G4004.1	115	1	A1E	1.7	265.9	-20.7	-6.0	
S.E.S. CONTAINER	G4004.2	115	2	A1E	1.4	265.9	-20.7	-6.0	
BAG, D.S.B. DISPENSER	G4004.3	115	4	A1E	3.0	265.9	-20.7	-6.0	
DRIVE TUBES IN BAG 5	G4004.4	115	3	A1E	1.9	265.9	-20.7	-6.0	
SAMPLES IN DRIVE TUBE G4004.4	N/A	115	1	A1E	3.9	265.9	-20.7	-6.0	
CAPS AND DISPENSERS	G4004.5	115	2	A1E	.2	265.9	-20.7	-6.0	
ORGANIC SAMPLE	G4004.6	115	1	A1E	.2	265.9	-20.7	-6.0	
SAMPLES IN BAG 5	N/A	115	1	A1E	12.9	265.9	-20.7	-6.0	
BAG, SAMPLE RETURN	G3060.	111	1	JN PLUS 227 BULKHEAD	3.2	221.8	-1.0	29.5	
SAMPLES IN G3061.	N/A	111	1	JN PLUS 227 BULKHEAD	31.8	221.8	-1.0	29.5	
MAGAZINE, JV	G4042.	111	1	VOLUME CENTROID AS	2.0	254.0	.0	.0	
SAMPLE COLLECTION BAG 4	G4078.	115	1	LOWER BAY RHSSC	1.7	238.0	38.0	42.7	
BAG, SAMPLE CONTAINMENT	G3078.	115	1	LOWER BAY RHSSC	.6	238.0	39.0	42.7	
SAMPLES IN BAG 4	N/A	111	1	LOWER BAY RHSSC	25.2	238.0	38.0	42.7	
BAG, SAMPLE COLLECTION	G3078.	111	1	LOWER MID-SECTION	.6	240.5	-18.0	13.3	
SAMPLE COLLECTION BAG 3	G4048.	111	1	LOWER MID-SECTION	1.2	240.5	-18.0	13.3	
SAMPLES IN BAG 3	N/A	115	1	LOWER MID-SECTION	12.9	240.5	-18.0	13.3	
DRIVE TUBES IN BAG 5	G4004.4	115	3	A1E	1.9	265.9	-20.7	-6.0	
SAMPLES IN DRIVE TUBE G4004.4	N/A	115	1	A1E	3.9	265.9	-20.7	-6.0	
CAPS AND DISPENSERS	G4003.7	115	1	A1F	.1	257.4	-20.7	-6.0	

3.2-67

SNA-8-D-027(III) REV 3

TABLE 3.2-9.2 (CONTINUED)

Amendment 114
9/15/71

MISSION J-2 TRANSFERRED CREW AND EQUIPMENT STORAGE LIST								
ITEMS TRANSFERRED FROM ASC. STAGE INTO C4 PRIOR TO ASC. STAGE JETTISON (15)								
LM COORDINATES								
DESCRIPTION	STOR. ITEM	REF	NO.	STORAGE LOCATION	WEIGHT	X-C.G.	Y-C.G.	Z-C.G.
SAMPLE COLLECTION BAG B	04048.	111	1	AFT ENG CAN(A14A)	1.2	239.6	-5.5	-14.8
SAMPLES IN BAG B	N/A	115	1	AFT ENG CAN(A14A)	12.9	239.6	-5.5	-14.8
BAG, SAMPLE CONTAINMENT	03078.	111	1	AFT ENG CAN(A14A)	.6	239.6	-5.5	-14.3
CONTAINER, CORE TUBE	03074.	111	1	AFT ENG CAN(A14A)	1.4	239.6	-5.5	-14.3
DRIVE TUBES IN BAG 1	04003.4	115	3	AIF	1.9	257.4	-20.7	-6.0
SAMPLES IN DRIVE TUBE 04003.4	N/A	115	1	AIF	4.0	257.4	-20.7	-6.0
BAG, 70MM MAGAZINE XFR	05466.	111	1	AIK	.3	273.7	-20.0	-8.5
BAG, 70MM MAGAZINE XFR	05466.	111	1	AIK	.3	273.7	-20.0	-8.5
UTILITY STRAP	00315.	111	3	FLJ	.1	229.5	-35.5	35.0
INFLIGHT RETAINER STRAPS	00360.	111	4	FLJ	NEGL	229.5	-35.5	35.0
2 CREW+EQUIP, LM-C4					817.02	251.30	-2.65	28.22

3.2-68

SNA-8-D-027(111) REV 3

U
S
N
A
S
P
A
C
E
A
G
E
N
C
Y
R
E
P
O
R
T
N
O

TABLE 3.2-9.2 (CONTINUED)

Amendment 114
9/15/71

MISSION J-2 TRANSFERRED CREW AND EQUIPMENT STORAGE LIST								
ITEMS TRANSFERRED FROM ASC. STAGE INTO LA PRIG: TO ASC. STAGE JETTISON (16)								
APOLLO COORDINATES								
DESCRIPTION	STOW. ITEM	REF	NO.	STORAGE LOCATION	WEIGHT	X-C.G.	Y-C.G.	Z-C.G.
CHRONOGRAPH - 002	A0202.	111	1	JN CREW	.1	1050.0	.0	-14.9
CHRONOGRAPH - 002	A0202.	111	1	JN CREW	.1	1050.0	.0	-14.9
WATCHBAND	A0203.	111	1	JN CREW	NEGL	1050.0	.0	-14.9
WATCHBAND	A0203.	111	1	JN CREW	NEGL	1050.0	.0	-14.9
PENS, DATA RECORDING	A0204.	111	1	JN CREW	.1	1042.8	12.5	-20.7
PENS, DATA RECORDING	A0204.	111	1	JN CREW	.1	1042.8	12.5	-20.7
PEN, MARKER	A0205.	111	1	JN CREW	NEGL	1042.8	12.5	-20.7
PEN, MARKER	A0205.	111	1	JN CREW	NEGL	1042.8	12.5	-20.7
PENCIL	A0206.	111	1	JN CREW	.1	1042.8	12.5	-20.7
PENCIL	A0206.	111	1	JN CREW	.1	1042.8	12.5	-20.7
KIT, PILOTS PREFERENCE	A1007.	111	2	AREA A6	1.8	1011.0	21.0	-23.0
KIT, PILOTS PREFERENCE	A1007.	111	1	AREA A6	.9	1011.0	21.0	-23.0
MAGAZINE, 70MM LUNAR SURFACE	A0108.1	111	3	AREA R13	4.2	1024.0	45.0	-26.0
MAGAZINE, 70MM LUNAR SURFACE	A0108.1	111	2	LN XFR BAG (A8)	2.8	1011.0	21.0	-23.0
SUBSYSTEM, FECAL CONTAINMENT	B0113.	111	*1	JN CREW RH STA	.3	1043.0	24.5	-11.9
SUBSYSTEM, FECAL CONTAINMENT	B0113.	111	*1	JN CREW CTR STA	.3	1043.0	.0	-11.9
HARNES, CWG ELECTRICAL (CON)	B0135.	111	1	LN ADAPTER BAG (A8)	.4	1011.0	21.0	-23.0
HARNES, CWG ELECTRICAL (LMP)	B0135.	111	1	LN ADAPTER BAG (A8)	.4	1011.0	21.0	-23.0
SCISSORS	B0204.	111	1	JN CREW	.5	1047.2	.0	-23.4
UCTA	B0205.	111	1	JN CREW	.5	1043.0	.0	-5.9
JCTA	B0205.	111	1	JN CREW	.5	1043.0	.0	-5.9
PENLIGHTS	B0206.	111	1	JN CREW	.3	1042.8	-7.6	-20.7
PENLIGHTS	B0206.	111	1	JN CREW	.3	1042.8	-7.6	-20.7
BIOBELT ASSY	B0207.	111	1	JN CREW	.2	1041.0	.0	-12.9
BIOBELT ASSY	B0207.	111	1	JN CREW	.2	1041.0	.0	-12.9
ITLSA - EV	B0211.	111	1	JN CREW RH STA	46.9	1043.0	24.5	-11.9
ITLSA - EV	B0211.	111	1	JN CREW CTR STA	46.9	1043.0	.0	-11.9
GLOVES, IV PAIR	B0213.	111	1	JN CREW RH STA	2.0	1043.0	24.5	-11.9
GLOVES, IV PAIR	B0213.	111	1	JN CREW CTR STA	2.0	1043.0	.0	-11.9
HELMET ASSY, PRESSURE	B0214.	111	1	JN CREW RH STA	2.7	1043.0	24.5	-11.9

3.2-70

SNA-B-D-027(III) REV 3

TABLE 3.2-9.2 (CONTINUED)

Amendment 114
9/15/71

MISSION J-2 TRANSFERRED CREW AND EQUIPMENT STORAGE LIST								
ITEMS TRANSFERRED FROM ASC. STAGE INTO CM PRIOR TO ASC. STAGE JETTISON (16)								
APOLLO COORDINATES								
DESCRIPTION	STW. NO. ITEM	REF	NO.	STORAGE LOCATION	W FLIGHT	X-C.G.	Y-C.G.	Z-C.G.
HELMET ASSY, PRESSURE	B0214.	111	1	DN CREW LTR STA	2.7	1043.0	.0	-11.9
HARNESS, ELEC - SUIT	B0224.	111	1	DN CREW LTR STA	.4	1043.0	.0	-11.9
HARNESS, ELEC - SUIT	B0224.	111	1	DN CREW RH STA	.4	1043.0	24.5	-11.9
HARNESS, BIOINSTRUMENTATION	B0216.	111	1	DN CREW LTR STA	.2	1043.0	.0	-11.9
HARNESS, BIOINSTRUMENTATION	B0216.	111	1	DN CREW RH STA	.2	1043.0	24.5	-11.9
COMMUNICATION CARRIER	B0217.	111	1	DN CREW RH STA	1.6	1043.0	24.5	-11.9
COMMUNICATION CARRIER	B0217.	111	1	DN CREW LTR STA	1.6	1043.0	.0	-11.9
POCKET, SCISSORS (CM)	B0218.	111	1	DN PGA CT CREW STA	.2	1043.0	.0	-11.9
POCKET, SCISSORS (LMP)	B0218.	111	1	DN PGA RH CREW STA	.2	1043.0	24.5	-11.9
POCKET, CHECKLIST (CM)	B0219.	111	1	DN PGA CT CREW STA	.2	1043.0	.0	-11.9
POCKET, CHECKLIST (LMP)	B0219.	111	1	DN PGA RH CREW STA	.2	1043.0	24.5	-11.9
POCKET, DATA (CM)	B0220.	111	1	DN PGA CT CREW STA	.2	1043.0	.0	-11.9
POCKET, DATA (LMP)	B0220.	111	1	DN CREW RH STA	.2	1043.0	24.5	-11.9
CAP, ELECTRICAL CONNECTOR	B0138.	111	1	DN CREW RH STA	NEGL	1043.0	24.5	-11.9
CAP, ELECTRICAL CONNECTOR	B0138.	111	1	DN CREW LTR STA	NEGL	1043.0	.0	-11.9
CAP, PROTECTIVE-CWG BIO HARNESS	C0112.35	111	1	AREA RB	NEGL	1052.0	46.0	12.0
CAP, PROTECTIVE-CWG BIO HARNESS	C0112.35	111	1	AREA RB	NEGL	1052.0	46.0	12.0
BAG, JETTISON STORAGE	B1027.	111	1	ISA (A2)	.9	1019.0	-22.0	8.0
FLIGHT DATA FILE ASSY	A1008.	111	1	ISA (A2)	7.0	1019.0	-22.0	8.0
JUST COVER, NECK RING	B1065.	111	2	ITLSA IN PGA CONT.	.2	1011.0	.0	-20.0
BAG, COSMIC RAY PACKAGE	B0047.	111	1	AREA U2	.7	1033.0	-23.0	-50.0
DETECTOR ARRAY ASSY	G4023.1	111	1	AREA U2	8.0	1033.0	-23.0	-50.0
OXYGEN PURGE SYSTEM	B1012	111	1	AREA A7	32.3	1011.0	22.0	9.0
BAG, HELMET STORAGE	B1058.	115	* 1	IN CM PGA CONTAINER	1.4	1015.0	.0	-20.0
BAG, HELMET STORAGE	B1058.	115	1	IN CM PGA CONTAINER	1.4	1015.0	.0	-20.0
LUNAR EXTRAVEHICULAR VISOR	B1014.	115	1	IN CM PGA CONTAINER	5.6	1015.0	.0	-20.0
LUNAR EXTRAVEHICULAR VISOR	B1014.	115	1	IN CM PGA CONTAINER	5.6	1015.0	.0	-20.0
GLOVES, EV (PAIR)	B1015.	111	1	IN CM PGA CONTAINER	2.9	1015.0	.0	-20.0
GLOVES, EV (PAIR)	B1015.	111	1	IN CM PGA CONTAINER	2.9	1015.0	.0	-20.0
KIT, ECU MAINTENANCE	B1016.	115	1	ISA (A2)	.5	1019.0	-22.0	8.0

3.2-71

SMA-8-D-027(III) REV 3

TABLE 3.2-9.2 (CONTINUED)

Amendment 114
9/15/71

MISSION J-2 TRANSFERRED CREW AND EQUIPMENT STORAGE LIST								
ITEMS TRANSFERRED FROM ASC. STAGE INTO CM PRIOR TO ASC. STAGE JETTISON (16)								
APOLLO COORDINATES								
DESCRIPTION	STOW. ITEM	REF	NO.	STORAGE LOCATION	WEIGHT	X-C.G.	Y-C.G.	Z-C.G.
PURGE VALVE ASSY.	H1017.	115	1	AREA A7	.6	1011.0	22.0	8.0
TETHER, WAIST EVA	H1020.6	115	1	AREA A7	.6	1011.0	22.0	8.0
TETHER, WAIST EVA	H1020.7	115	1	AREA A7	.6	1011.0	22.0	8.0
GARMENT, LIQUID COOLING	H1030.	111	1	DN CREW CH STA	4.4	1043.0	24.5	-11.9
GARMENT, LIQUID COOLING	H1030.	111	1	DN CREW CH STA	4.4	1043.0	.0	-11.9
DEVICE, IN-SUIT DRINKING	H1049.	111	1	DN CREW CH STA	.3	1043.0	24.5	-11.9
DEVICE, IN-SUIT DRINKING	H1049.	111	1	DN CREW CH STA	.3	1043.0	.0	-11.9
ASSY, MIC INSTRUMENTATION	D0201.	111	1	DN CREW	1.1	1041.0	.0	-12.9
ASSY, MIC INSTRUMENTATION	D0201.	111	1	DN CREW	1.1	1041.0	.0	-12.9
DOSIMETER, PERSONAL	D0200.	117	1	DN CREW	.4	1046.0	.0	-23.4
DOSIMETER, PERSONAL	D0200.	117	1	DN CREW	.4	1046.0	.0	-23.4
DOSIMETER, PASSIVE	D0201.	117	3	DN CREW CH STA	NEGL	1043.0	24.5	-11.9
DOSIMETER, PASSIVE	D0201.	117	3	DN CREW CH STA	NEGL	1043.0	.0	-11.9
HEADSET, LIGHTWEIGHT	E0111.	111	1	AREA A8	.4	1011.0	21.0	-23.0
HEADSET, LIGHTWEIGHT	E0112.	111	1	AREA A8	.4	1011.0	21.0	-23.0
EARPIECE, MOULDED (COMM. CARRIER)	E0200.1	111	1	DN CREW	NEGL	1050.0	.0	-24.0
EARPIECE, MOULDED (COMM. CARRIER)	E0200.1	111	1	DN CREW	NEGL	1050.0	.0	-24.0
EARTUBE (COMM. CARRIER)	E0200.2	111	2	DN CREW	NEGL	1050.0	.0	-24.0
EARTUBE (COMM. CARRIER)	E0200.2	111	2	DN CREW	NEGL	1050.0	.0	-24.0
CONTR. CONTINGENCY, LUN. SAM. KIT	G4016.	115	1	ISA (A2)	2.7	1019.0	-22.0	8.0
BRUSH, LENS	A1042.	111	1	ISA (A2)	.1	1019.0	-22.0	8.0
FLAG KIT, STANDARD	N1072.	166	1	AREA A8	.8	1011.0	21.0	-23.0
DSEA	U3005.	115	1	AREA A8	2.3	1011.0	21.0	-23.0
BAG, EQUIPMENT TRANSFER	G3018.	111	1	ISA (A2)	.9	1019.0	-22.0	8.0
BAG, TEMPORARY STORAGE	G3031.	111	1	AREA A8	.9	1011.0	21.0	-23.0
UPPER HOUSING ASSY, PENETRIMETER	G4049.1	111	1	AREA A7	2.0	1011.0	22.0	8.0
SAMPLE COLLECTION BAG 7	G3075.	111	1	DN AREA A8	1.7	1016.0	.0	16.0
BAG, SAMPLE CONTAINMENT	G3075.	111	1	DN AREA A8	.6	1016.0	.0	16.0
SAMPLES IN BAG 7	N/A	115	1	DN AREA A8	25.1	1016.0	.0	16.0
CONTAINER, SRC NO. 1	G4003.	115	1	AREA A8	14.1	1031.0	-8.0	39.0

3.2-72

SNA-B-D-027(III) REV 3

W
H
I
T
L
I
N
E
S
O
F
T
W
A
R
E
A
S
E
R
S
O
F
T
W
A
R
E
A
S
E
R
S

TABLE 3.2-9.2 (CONTINUED)

Amendment 114
9/15/71

MISSION J-2 TRANSFERRED CREW AND EQUIPMENT STORAGE LIST								
ITEMS TRANSFERRED FROM ASC. STAGE INTO CM PRIOR TO ASC. STAGE JETTISON (16)								
APOLLO COORDINATES								
DESCRIPTION	STGW. ITEM	REF	NO.	STORAGE LOCATION	WEIGHT	X-C.G.	Y-C.G.	Z-C.G.
SAMPLE COLLECTION BAG 1	G4003.1	115	1	AREA B5	1.7	1031.0	-8.0	39.0
S.E.S. CONTAINER	G4003.2	115	1	AREA B5	.7	1031.0	-8.0	39.0
BAG, D.S.B. DISPENSER	G4003.3	115	2	AREA B5	1.5	1031.0	-8.0	39.0
DRILL STEMS IN BAG 1	G4003.5	115	6	AREA B5	2.6	1031.0	-8.0	39.0
SAMPLES IN DRILL STEM G4003.6	N/A	115	1	AREA B5	3.0	1031.0	-8.0	39.0
CAPS AND DISPENSERS	G4003.5	115	1	AREA B5	.2	1031.0	-8.0	39.0
ORGANIC SAMPLES	G4003.8	115	1	AREA B5	.2	1031.0	-8.0	39.0
SAMPLES IN BAG 1	N/A	115	1	AREA B5	15.1	1031.0	-8.0	39.0
EVA GUFF CHECKLIST	A1040.	111	4	ISA (A2)	1.2	1019.0	-22.0	8.0
CONTAINER, SRC NO.2	G4004.	115	1	AREA B6	13.9	1031.0	13.0	39.0
SAMPLE COLLECTION BAG 5	G4004.1	115	1	AREA B5	1.7	1031.0	13.0	39.0
S.E.S. CONTAINER	G4004.2	115	2	AREA B5	1.4	1031.0	13.0	39.0
BAG, D.S.B. DISPENSER	G4004.3	115	4	AREA B6	3.0	1031.0	13.0	39.0
DRIVE TUBES IN BAG 5	G4004.4	115	3	AREA B6	1.9	1031.0	13.0	39.0
SAMPLES IN DRIVE TUBE G4004.4	N/A	115	1	AREA B6	3.9	1031.0	13.0	39.0
CAPS AND DISPENSERS	G4004.5	115	2	AREA B6	.2	1031.0	13.0	39.0
ORGANIC SAMPLE	G4004.6	115	1	AREA B6	.2	1031.0	13.0	39.0
SAMPLES IN BAG 5	N/A	115	1	AREA B6	12.9	1031.0	13.0	39.0
BAG, SAMPLE RETURN	G3060.	111	1	IN AREA A7	3.2	1019.0	22.0	8.0
SAMPLES IN G3060.	N/A	111	1	IN AREA A7	31.8	1019.0	22.0	8.0
MAGAZINE, UV	G4042.	111	1	VOLUME CONTROLLED CM	2.0	1040.0	.0	.0
SAMPLE COLLECTION BAG 4	G4050.	115	1	IN AREA A1	1.7	1017.0	-21.0	-22.0
BAG, SAMPLE CONTAINMENT	G3078.	115	1	IN AREA A1	.6	1017.0	-21.0	-22.0
SAMPLES IN BAG 4	N/A	111	1	IN AREA A1	25.2	1017.0	-21.0	-22.0
BAG, SAMPLE COLLECTION	G3078.	111	1	BETWEEN PGA AND A9	.6	1014.0	.0	8.0
SAMPLE COLLECTION BAG 3	G4048.	111	1	BETWEEN PGA AND A9	1.2	1014.0	.0	8.0
SAMPLES IN BAG 3	N/A	115	1	BETWEEN PGA AND A9	12.9	1014.0	.0	8.0
DRIVE TUBES IN BAG 5	G4004.4	115	3	AREA B6	1.9	1031.0	13.0	39.0
SAMPLES IN DRIVE TUBE G4004.4	N/A	115	1	AREA B6	3.9	1031.0	13.0	39.0
CAPS AND DISPENSERS	G4003.7	115	1	AREA B5	.1	1031.0	-8.0	39.0

3.2-73

SNA-8-D-027(III) REV 3

TABLE 3.2-9.2 (CONTINUED)

Amendment 114
9/15/71

MISSION J-2 TRANSFERRED CREW AND EQUIPMENT STORAGE LIST								
ITEMS TRANSFERRED FROM ASC. STAGE INTO CM PRIOR TO ASC. STAGE JETTISON (16)								
APPLIC. COORDINATES								
DESCRIPTION	STCW. ITEM	REF	NO.	STORAGE LOCATION	WEIGHT	X-C.G.	Y-C.G.	Z-C.G.
SAMPLE COLLECTION BAG B	U4049.	111	1	ON AREA A9	1.2	1016.0	.0	16.0
SAMPLES IN BAG B	N/A	115	1	ON AREA A9	12.9	1016.0	.0	16.0
BAG, SAMPLE CONTAINMENT	U3078.	111	1	ON AREA A9	.6	1016.0	.0	16.0
CONTAINER, CORE TUBE	U3074.	111	1	AREA A9	1.4	1013.0	.0	16.0
DRIVE TUBES IN BAG I	U4003.4	115	3	AREA B5	1.9	1031.0	-8.0	39.0
SAMPLES IN DRIVE TUBE U4003.4	N/A	115	1	AREA B5	4.0	1031.0	-9.0	39.0
BAG, 7MM MAGAZINE XFR	U6466.	111	1	AREA A8	.3	1011.0	21.0	-23.0
BAG, 7MM MAGAZINE XFR	U6466.	111	1	AREA A14	.3	1024.0	45.0	-26.0
UTILITY STRAP	U6315.	111	3	AREA A-3	.1	1059.0	44.0	15.0
INFLIGHT RETAINER STRAPS	U3360.	111	4	AREA A-5	NEGL	1059.0	44.0	15.0
2 CREW+EQUIP, LM-CM					817.02	1033.29	8.32	-2.33

3.2-74

SNA-8-D-027(III) REV 3

U
N
I
T
E
D
S
T
A
T
E
S
O
F
A
M
E
R
I
C
A

TABLE 3.2-9.2 (CONTINUED)

Amendment 114
9/15/71

MISSION J-7 TRANSFERRED CREW AND EQUIPMENT STORAGE LIST								
ITEMS TRANSFERRED FROM CM INTO ASC. STAGE PRIOR TO ASC. STAGE JETTISON (17)								
APPLIED COORDINATES								
DESCRIPTION	STOW. ITEM	REF	NO.	STORAGE LOCATION	WEIGHT	X-C.G.	Y-C.G.	Z-C.G.
CSM/L4 UMBILICAL SUBSYSTEM, FECAL CONTAINMENT	TBD	222	1	UNDER RH COUCH	1.1	1018.0	24.5	-15.0
SUBSYSTEM, FECAL CONTAINMENT	B0113.	111	*1	IN CREW KIT STA	.3	1043.0	24.5	-11.9
SUBSYSTEM, FECAL CONTAINMENT	B0113.	111	*1	IN CREW CTR STA	.3	1043.0	.0	-11.9
BAG, JETTISON STORAGE	B0147.	111	1	AREA A2	.9	1011.0	-22.0	8.0
DEVICE, IN-SUIT DRINKING	H1048.	111	1	IN CREW RH STA	.3	1043.0	24.5	-11.9
DEVICE, IN-SUIT DRINKING	H1048.	111	1	IN CREW CTR STA	.3	1043.0	.0	-11.9
FOOD PACKAGE	C0111.	111	1	AREA A7	30.0	1011.0	22.0	8.0
FECAL COLLECTION ASSY	C0311.	111	12	AREA A7	2.4	1011.0	22.0	8.0
CO2 ABSORBER USED	U0327.	121	4	AREA B5	28.0	1031.0	-8.0	39.0
CO2 ABSORBER USED	U0327.	121	4	AREA B6	28.0	1031.0	13.0	39.0
CO2 ABSORBER USED	U0327.	121	4	AREA A9	28.0	1013.0	.0	16.0
SH14, CO2 ABSORBER	U0328.	161	4	AREA B5	.8	1031.0	-8.0	39.0
SH14, CO2 ABSORBER	U0328.	161	4	AREA B6	.8	1031.0	13.0	39.0
SH14S, CO2 ABSORBER	U0328.	161	4	AREA A9	.8	1013.0	.0	16.0
CONTAINER, B5	U0342.	111	1	AREA B5	14.5	1031.0	-8.0	39.0
CONTAINER, B6	U0343.	111	1	AREA B6	14.5	1031.0	13.0	39.0
DOCKING PROBE AND MECHANISM	U0349.	222	1	IN CM TUNNEL	199.3	1110.3	.0	.0
BAG, FECAL COLLECTION ASSY.	U6418.	111	1	AREA A7	1.1	1011.0	22.0	8.0
EQUIP. XFER. CM-L4					351.40	1072.54	2.78	11.62

3.2-75

SMA-8-D-027(111) REV 3

U
N
I
T
E
D
S
T
A
T
E
S
O
F
A
M
E
R
I
C
A

Amendment 114
9/15/71

TABLE 3.2-9.2 (CONTINUED)

MISSION J-2 TRANSFERRED CREW AND EQUIPMENT STORAGE LIST								
ITEMS TRANSFERRED FROM CM INTO ASC. STAGE PRIOR TO ASC. STAGE JETTISON (18)								
CM COORDINATES								
DESCRIPTION	STOR. ITEM	REF	NO.	STORAGE LOCATION	WEIGHT	X-C.G.	Y-C.G.	Z-C.G.
DOCKING STRUCTURE	1A0	111	1	OV CABIN FLOOR	111.7	218.5	-22.0	43.0
CSM/LM UTILICAL	1A0	222	1	IN LM TUNNEL	1.1	300.0	.0	.0
SUBSYSTEM, FECAL CONTAINMENT	00113.	111	*1	VOLUME CENTROID AS	.3	254.0	.0	.0
SUBSYSTEM, FECAL CONTAINMENT	00113.	111	*1	VOLUME CENTROID AS	.3	254.0	.0	.0
BAG, JETTISON STORAGE	00147.	111	1	VOLUME CENTROID AS	.9	254.0	.0	.0
DEVICE, IN-SUIT DRINKING	01048.	111	1	VOLUME CENTROID AS	.3	254.0	.0	.0
DEVICE, IN-SUIT DRINKING	01048.	111	1	VOLUME CENTROID AS	.3	254.0	.0	.0
FOOD PACKAGE	00111.	111	1	VOLUME CENTROID AS	30.0	254.0	.0	.0
FECAL COLLECTION ASSY	00311.	111	12	VOLUME CENTROID AS	2.4	254.0	.0	.0
CO2 ABSORBER USED	00327.	121	4	VOLUME CENTROID AS	28.0	254.0	.0	.0
CO2 ABSORBER USED	00327.	121	4	VOLUME CENTROID AS	28.0	254.0	.0	.0
CO2 ABSORBER USED	00327.	121	4	VOLUME CENTROID AS	28.0	254.0	.0	.0
SHIM, CO2 ABSORBER	00328.	161	4	VOLUME CENTROID AS	.8	254.0	.0	.0
SHIM, CO2 ABSORBER	00328.	161	4	VOLUME CENTROID AS	.8	254.0	.0	.0
SHIMS, CO2 ABSORBER	00328.	161	4	VOLUME CENTROID AS	.8	254.0	.0	.0
CONTAINER, 05	00342.	111	1	VOLUME CENTROID AS	14.5	254.0	.0	.0
CONTAINER, 06	00343.	111	1	VOLUME CENTROID AS	14.5	254.0	.0	.0
DOCKING PRGBE	00349.	222	1	F3	87.0	221.0	13.0	51.0
BAG, FECAL COLLECTION ASSY.	00418.	111	1	VOLUME CENTROID AS	1.1	254.0	.0	.0
EQUIP. XFR. CM-LM					351.40	234.63	-2.51	26.38

3.2-76

SMA-8-D-027(III) REV 3

TABLE 3.2-9.2 (CONTINUED)

Amendment 114
9/15/71

MISSION J-2 TRANSFERRED CREW AND EQUIPMENT STORAGE LIST								
ITEMS REARRANGED IN ASC. STAGE PRIOR TO ASC. STAGE JETTISON (19)								
LM COORDINATES								
DESCRIPTION	STOW. ITEM	REF	NO.	STORAGE LOCATION	WEIGHT	X-C.G.	Y-C.G.	Z-C.G.
DOCKING CHARGE	F1000.	112	1	IN LM TUNNEL	21.4	300.0	.0	.0
LM EQUIP. RELOC. 3					21.40	300.00	.00	.00

3.2-77

SMA-8-D-027(III) REV 3

U
N
I
T
E
D
S
T
A
T
E
S
O
F
A
M
E
R
I
C
A

TABLE 3.2-9.2 (CONTINUED)

Amendment 114
9/15/71

MISSION J-2 TRANSFERRED CREW AND EQUIPMENT STOWAGE LIST								
ITEMS REARRANGED IN CP POST A/S JETTISON (21)								
APPLIED COORDINATES								
DESCRIPTION	STOW. ITEM	REF	NO.	STOWAGE LOCATION	WEIGHT	X-C.G.	Y-C.G.	Z-C.G.
COMMUNICATION CARRIER	B0217.	111	1	JN CREW LH STA	1.6	1043.0	-24.5	-11.9
COMMUNICATION CARRIER	B0217.	111	1	JN CREW RH STA	1.6	1043.0	24.5	-11.9
COMMUNICATION CARRIER	B0217.	111	1	JN CREW CTR STA	1.6	1043.0	.0	-11.9
POCKET, SCISSORS (CMP)	B0218.	111	1	JN PUA LH CREW STA	.2	1043.0	-24.5	-11.9
POCKET, SCISSORS (CDR)	B0218.	111	1	JN PUA CT CREW STA	.2	1043.0	.0	-11.9
POCKET, SCISSORS (LMP)	B0218.	111	1	JN PUA RH CREW STA	.2	1043.0	24.5	-11.9
POCKET, CHECKLIST (CDR)	B0219.	111	1	JN PUA CT CREW STA	.2	1043.0	.0	-11.9
POCKET, CHECKLIST (LMP)	B0219.	111	1	JN PUA RH CREW STA	.2	1043.0	24.5	-11.9
POCKET, DATA (CDR)	B0220.	111	1	JN PUA CT CREW STA	.2	1043.0	.0	-11.9
POCKET, DATA (LMP)	B0220.	111	1	JN PUA RH CREW STA	.2	1043.0	24.5	-11.9
POCKET, CHECKLIST (CMP)	B0221.	111	1	JN PUA LH CREW STA	.2	1043.0	-24.5	-11.9
POCKET, DATA (CMP)	B0222.	111	1	JN PUA LH CREW STA	.2	1043.0	-24.5	-11.9
CAP, ELECTRICAL CONNECTOR	B0138.	111	1	JN CREW RH STA	NEGL	1043.0	24.5	-11.9
CAP, ELECTRICAL CONNECTOR	B0138.	111	1	JN CREW CTR STA	NEGL	1043.0	.0	-11.9
DECON. BAG, COSMIC RAY PACKAGE	06361.	111	1	AREA A2	1.0	1011.0	-22.0	8.0
GARMENT, LIQUID COOLING	B1030.	111	1	JN CREW RH STA	4.4	1043.0	24.5	-11.9
GARMENT, LIQUID COOLING	B1030.	111	1	JN CREW CTR STA	4.4	1043.0	.0	-11.9
HEADSET, LIGHTWEIGHT	E0111.	111	1	AREA A8	.4	1011.0	21.0	-23.0
HEADSET, LIGHTWEIGHT	E0112.	111	1	AREA A8	.4	1011.0	21.0	-23.0
HEADSET, LIGHTWEIGHT	E0113.	111	1	AREA A3	.4	1011.0	21.0	-23.0
EARTUBE, UNIVERSAL (CMP)	E0114.	111	1	AREA U2	NEGL	1033.0	-23.0	-50.0
EARTUBE, UNIVERSAL (CDR)	E0115.	111	1	AREA U2	NEGL	1033.0	-23.0	-50.0
EARTUBE, UNIVERSAL (LMP)	E0116.	111	1	AREA U2	NEGL	1033.0	-23.0	-50.0
CARRIER ASSY, CONT. A9	06423.	111	1	AREA A9	2.5	1013.0	.0	16.0
TETHER, IV CREWMAN	06429.	111	1	AREA A2	.5	1011.0	-22.0	8.0
DECON. BAG, PENETROMETER	06461.	111	1	TOP OF AREA A-2	.8	1016.0	-22.0	8.0
DECON. BAG, LUNAR SAMPLE	06426.	111	1	TOP OF AREA A-2	3.4	1016.0	-22.0	9.0
BAG, DECONTAMINATION	06426.	111	1	TOP OF AREA A-2	3.4	1016.0	-27.0	8.0
CM EQUIP. RELOC. 3					199.10	1039.07	-1.66	-12.80

3.2-80

SNA-B-D-027(III) REV 3

TABLE 3.2-9.2 (CONTINUED)

Amendment 114
9/15/71

MISSION J-2 TRANSFERRED CREW AND EQUIPMENT STORAGE LIST								
ITEMS REARRANGED IN CM POST A/S JETTISON (22)								
						APPLIED COORDINATES		
DESCRIPTION	STOW. ITEM	REF	NO.	STORAGE LOCATION	WEIGHT	X-C.G.	Y-C.G.	Z-C.G.
COMMUNICATION CARRIER	B0217.	111	1	GNIC PANEL	1.6	1050.0	.0	22.0
COMMUNICATION CARRIER	B0217.	111	1	GNIC PANEL	1.6	1050.0	.0	22.0
COMMUNICATION CARRIER	B0217.	111	1	GNIC PANEL	1.6	1050.0	.0	22.0
POCKET, SCISSORS (CMP)	B0218.	111	1	DN ICG LH STA	.2	1043.0	-24.5	-11.9
POCKET, SCISSORS (CDK)	B0218.	111	1	DN ICG CTR STA	.2	1043.0	.0	-11.9
POCKET, SCISSORS (LMP)	B0218.	111	1	DN ICG RH STA	.2	1043.0	24.5	-11.9
POCKET, CHECKLIST (CDK)	B0219.	111	1	DN ICG CTR STA	.2	1043.0	.0	-11.9
POCKET, CHECKLIST (LMP)	B0219.	111	1	DN ICG RH STA	.2	1043.0	24.5	-11.9
POCKET, DATA (CDK)	B0220.	111	1	DN ICG CTR STA	.2	1043.0	.0	-11.9
POCKET, DATA (LMP)	B0220.	111	1	DN ICG RH STA	.2	1043.0	24.5	-11.9
POCKET, CHECKLIST (CDK)	B0221.	111	1	DN ICG LH STA	.2	1043.0	-24.5	-11.9
POCKET, DATA (CMP)	B0222.	111	1	DN ICG LH STA	.2	1043.0	-24.5	-11.9
CAP, ELECTRICAL CONNECTOR	B0138.	111	1	PGA CONTAINER	NEGL	1015.0	.0	-3.5
CAP, ELECTRICAL CONNECTOR	B0138.	111	1	PGA CONTAINER	NEGL	1015.0	.0	-3.5
DECON. BAG, COSMIC RAY PACKAGE	B0361.	111	1	AREA U2	1.0	1033.0	-23.0	-50.0
GARMENT, LIQUID COOLING	B1030.	111	1	AREA U1	4.4	1033.0	23.0	-50.0
GARMENT, LIQUID COOLING	B1030.	111	1	AREA U1	4.4	1033.0	23.0	-50.0
HEADSET, LIGHTWEIGHT	E0111.	111	1	DN CREW RH STA	.4	1043.0	24.5	-11.9
HEADSET, LIGHTWEIGHT	E0112.	111	1	DN CREW CTR STA	.4	1043.0	.0	-11.9
HEADSET, LIGHTWEIGHT	E0113.	111	1	DN CREW LH STA	.4	1043.0	-24.5	-11.9
EARTUBE, UNIVERSAL (CMP)	E0114.	111	1	DN CREW LH STA	NEGL	1043.0	-24.5	-11.9
EARTUBE, UNIVERSAL (CDK)	E0115.	111	1	DN CREW CTR STA	NEGL	1043.0	.0	-11.9
EARTUBE, UNIVERSAL (LMP)	E0116.	111	1	DN CREW RH STA	NEGL	1043.0	24.5	-11.9
CARRIER ASSY, CONT. AY	06403.	111	1	AREA A9	2.5	1013.0	.0	16.0
TETHER, IV CREWMAN	06429.	111	1	AREA A7	.5	1011.0	22.0	8.0
DECON BAG, PENETRUMETER	06461.	111	1	AREA A7	.8	1011.0	22.0	8.0
DECON. BAG, LUNAR SAMPLE	06426.	111	1	DN AREA A7	3.4	1019.0	22.0	8.0
BAG, DECONTAMINATION	06426.	111	1	DN AREA A1	3.4	1017.0	-21.0	-22.0
C4 EQUIP. RELUC. J					149.10	1019.73	4.13	-22.85

3.2-82

SMA-8-D-027(III) REV 3

U
N
I
T
E
D
S
T
A
T
E
S
O
F
A
M
E
R
I
C
A

TABLE 3.2-9.2 (CONTINUED)

Amendment 114
9/15/71

MISSION J-2 TRANSFERRED CREW AND EQUIPMENT STORAGE LIST								
ITEMS REARRANGED IN CM PRIOR TO PRE CSM AT EVA (23)								
DESCRIPTION	STOW. ITEM	REF	NO.	STORAGE LOCATION	WEIGHT	APOLLO COORDINATES		
						X-C.G.	Y-C.G.	Z-C.G.
BAG, MOTION SICKNESS	A0208.	111	1	LN PGA (PGA CONT)	.1	1011.0	.0	-14.0
BAG, MOTION SICKNESS	A0208.	111	1	JN PGA (PGA CONT)	.1	1011.0	.0	-14.0
BAG, MOTION SICKNESS	A0208.	111	1	JN PGA (PGA CONT)	.1	1011.0	.0	-14.0
JACKET ASSY, ICG	B0112.1	111	1	JN CREW RH STA	1.8	1043.0	24.5	-11.9
JACKET ASSY, ICG	B0112.1	111	1	JN CREW CTR STA	1.8	1043.0	.0	-11.9
JACKET ASSY, ICG	B0112.1	111	1	JN CREW LH STA	1.8	1043.0	-24.5	-11.9
TROUSER ASSY, ICG	B0112.2	111	1	JN CREW RH STA	1.8	1043.0	24.5	-11.9
TROUSER ASSY, ICG	B0112.2	111	1	JN CREW CTR STA	1.8	1043.0	.0	-11.9
TROUSER ASSY, ICG	B0112.2	111	1	JN CREW LH STA	1.8	1043.0	-24.5	-11.9
BOOT, RIGHT, ICG	B0112.3	111	1	JN CREW RH STA	.4	1043.0	24.5	-11.9
BOOT, RIGHT, ICG	B0112.3	111	1	JN CREW CTR STA	.4	1043.0	.0	-11.9
BOOT, RIGHT, ICG	B0112.3	111	1	JN CREW LH STA	.4	1043.0	-24.5	-11.9
BOOT, LEFT, ICG	B0112.4	111	1	JN CREW RH STA	.4	1043.0	24.5	-11.9
BOOT, LEFT, ICG	B0112.4	111	1	JN CREW CTR STA	.4	1043.0	.0	-11.9
BOOT, LEFT, ICG	B0112.4	111	1	JN CREW LH STA	.4	1043.0	-24.5	-11.9
SUBSYSTEM, FECAL CONTAINMENT	B0113.	111	1	AREA A2	.3	1011.0	-22.0	8.0
UCTA	B0205.	111	1	IN CM PGA CONTAINER	.5	1015.0	.0	-20.0
UCTA	B0205.	111	1	IN CM PGA CONTAINER	.5	1015.0	.0	-20.0
UCTA	B0223.	111	1	IN CM PGA CONTAINER	.5	1015.0	.0	-20.0
ITLSA - EV	B0211.	111	1	ITLSA IN PGA CONT.	46.9	1011.0	.0	-20.0
ITLSA - EV	B0211.	111	1	ITLSA IN PGA CONT.	46.9	1011.0	.0	-20.0
ITLSA - IV	B0212.	111	1	SLEEP RESTRAINT - RT	41.8	1018.0	23.0	-50.0
GLOVES, IV PAIR	B0213.	111	1	HELMET STOW BAG (L3)	2.0	1048.0	-47.0	12.0
GLOVES, IV PAIR	B0213.	111	1	HELMET STOW BAG (R1)	2.0	1050.0	-27.0	39.0
GLOVES, IV PAIR	B0213.	111	1	AFT DEK (RIGHT)	2.0	1018.0	23.0	-51.0
HELMET ASSY, PRESSURE	B0214.	111	1	AFT DEK (RIGHT)	2.7	1018.0	23.0	-51.0
HELMET ASSY, PRESSURE	B0214.	111	1	HELMET STOW BAG (B1)	2.7	1050.0	-27.0	39.0
HELMET ASSY, PRESSURE	B0214.	111	1	HELMET STOW BAG (L3)	2.7	1048.0	-47.0	12.0
COMMUNICATION CARRIER	B0217.	111	1	GNIC PANEL	1.6	1050.0	.0	22.0
COMMUNICATION CARRIER	B0217.	111	1	GNIC PANEL	1.6	1050.0	.0	22.0
COMMUNICATION CARRIER	B0217.	111	1	GNIC PANEL	1.6	1050.0	.0	22.0
PUCKET, SCISSORS (CMP)	B0218.	111	1	JN ICG LH STA	.2	1043.0	-24.5	-11.9

3.2-83

SNA-8-D-027(111) REV 3

TABLE 3.2-9.2 (CONTINUED)

Amendment 114
9/15/71

MISSION J-2 TRANSFERRED CREW AND EQUIPMENT STORAGE LIST								
ITEMS REARRANGED IN CM PRIOR TO PRE CS4 AT EVA (23)								
APPLIED COORDINATES								
DESCRIPTION	STOW. ITEM	REF	NO.	STORAGE LOCATION	WEIGHT	X-C.G.	Y-C.G.	Z-C.G.
POCKET, SCISSORS (CDR)	B0218.	111	1	04 ICG CTR STA	.2	1043.0	.0	-11.9
POCKET, SCISSORS (LMP)	B0218.	111	1	04 ICG RH STA	.2	1043.0	24.5	-11.9
POCKET, CHECKLIST (CDR)	B0219.	111	1	04 ICG CTR STA	.2	1043.0	.0	-11.9
POCKET, CHECKLIST (LMP)	B0219.	111	1	04 ICG RH STA	.2	1043.0	24.5	-11.9
POCKET, DATA (CDR)	B0220.	111	1	04 ICG CTR STA	.2	1043.0	.0	-11.9
POCKET, DATA (LMP)	B0220.	111	1	04 ICG RH STA	.2	1043.0	24.5	-11.9
POCKET, CHECKLIST (CDR)	B0221.	111	1	04 ICG LH STA	.2	1043.0	-24.5	-11.9
POCKET, DATA (LMP)	B0222.	111	1	04 ICG LH STA	.2	1043.0	-24.5	-11.9
HEADSET, LIGHTWEIGHT	E0111.	111	1	04 CREW RH STA	.4	1043.0	24.5	-11.9
HEADSET, LIGHTWEIGHT	E0112.	111	1	04 CREW CTR STA	.4	1043.0	.0	-11.9
HEADSET, LIGHTWEIGHT	E0113.	111	1	04 CREW LH STA	.4	1043.0	-24.5	-11.9
EARTUBE, UNIVERSAL (CMP)	E0114.	111	1	04 CREW LH STA	NEGL	1043.0	-24.5	-11.9
EARTUBE, UNIVERSAL (CDR)	E0115.	111	1	04 CREW CTR STA	NEGL	1043.0	.0	-11.9
EARTUBE, UNIVERSAL (LMP)	E0116.	111	1	04 CREW RH STA	NEGL	1043.0	24.5	-11.9
CM EQUIP. RELUC.4					172.80	1019.07	4.14	-23.64

3.2-84

SMA-8-0-027(III) REV 3

U
S
N
A
V
Y
A
I
R
F
O
R
C
E
S
S
P
A
C
E
S
H
I
P
D
E
V
E
L
O
P
M
E
N
T
A
C
T
I
V
I
T
Y
R
E
P
O
R
T
N
O
.

TABLE 3.2-9.2 (CONTINUED)

Amendment 114
9/15/71

MISSION J-2 TRANSFERRED CREW AND EQUIPMENT STORAGE LIST								
ITEMS REARRANGED IN CH PRIOR TO PRE CSM AT EVA (24)								
DESCRIPTION	STOW. ITEM	REF	NO.	STORAGE LOCATION	WEIGHT	APOLLO COORDINATES		
						X-C.G.	Y-C.G.	Z-C.G.
BAG, MOTION SICKNESS	A0208.	111	1	JN CREW	.1	1043.0	.0	-21.0
BAG, MOTION SICKNESS	AJ208.	111	1	JN CREW	.1	1043.0	.0	-21.0
BAG, MOTION SICKNESS	A0208.	111	1	JN CREW	.1	1043.0	.0	-21.0
JACKET ASSY, ICG	B0112.1	111	1	AREA U2	1.8	1033.0	-23.0	-50.0
JACKET ASSY, ICG	B0112.1	111	1	AREA U2	1.8	1033.0	-23.0	-50.0
JACKET ASSY, ICG	B0112.1	111	1	AREA U2	1.8	1033.0	-23.0	-50.0
TROUSER ASSY, ICG	B0112.2	111	1	AREA U2	1.8	1033.0	-23.0	-50.0
TROUSER ASSY, ICG	B0112.2	111	1	AREA U2	1.8	1033.0	-23.0	-50.0
TROUSER ASSY, ICG	B0112.2	111	1	AREA U2	1.8	1033.0	-23.0	-50.0
BOOT, RIGHT, ICG	B0112.3	111	1	AREA U2	.4	1033.0	-23.0	-50.0
BOOT, RIGHT, ICG	B0112.3	111	1	AREA U2	.4	1033.0	-23.0	-50.0
BOOT, RIGHT, ICG	B0112.3	111	1	AREA U2	.4	1033.0	-23.0	-50.0
BOOT, LEFT, ICG	B0112.4	111	1	AREA U2	.4	1033.0	-23.0	-50.0
BOOT, LEFT, ICG	B0112.4	111	1	AREA U2	.4	1033.0	-23.0	-50.0
BOOT, LEFT, ICG	B0112.4	111	1	AREA U2	.4	1033.0	-23.0	-50.0
SUBSYSTEM, FECAL CONTAINMENT	B0113.	111	1	JN CREW LH STA	.3	1043.0	-24.5	-11.9
UCTA	B0205.	111	1	JN CREW	.5	1043.0	.0	-5.9
UCTA	B0205.	111	1	JN CREW	.5	1043.0	.0	-5.9
UCTA	B0223.	111	1	JN CREW	.5	1043.0	.0	-5.9
ITLSA - EV	B0211.	111	1	JN CREW RH STA	46.9	1043.0	24.5	-11.9
ITLSA - EV	B0211.	111	1	JN CREW LTR STA	46.9	1043.0	.0	-11.9
ITLSA - IV	B0212.	111	1	JN CREW LH STA	41.8	1043.0	-24.5	-11.9
GLOVES, IV PAIR	B0213.	111	1	JN CREW LH STA	2.0	1043.0	-24.5	-11.9
GLOVES, IV PAIR	B0213.	111	1	JN CREW RH STA	2.0	1043.0	24.5	-11.9
GLOVES, IV PAIR	B0213.	111	1	JN CREW LTR STA	2.0	1043.0	.0	-11.9
HELMET ASSY, PRESSURE	B0214.	111	1	JN CREW LH STA	2.7	1043.0	-24.5	-11.9
HELMET ASSY, PRESSURE	B0214.	111	1	JN CREW RH STA	2.7	1043.0	24.5	-11.9
HELMET ASSY, PRESSURE	B0214.	111	1	JN CREW LTR STA	2.7	1043.0	.0	-11.9
COMMUNICATION CARRIER	B0217.	111	1	JN CREW LH STA	1.6	1043.0	-24.5	-11.9
COMMUNICATION CARRIER	B0217.	111	1	JN CREW RH STA	1.6	1043.0	24.5	-11.9
COMMUNICATION CARRIER	B0217.	111	1	JN CREW LTR STA	1.6	1043.0	.0	-11.9
POCKET, SCISSORS (CMP)	B0218.	111	1	JN PGA LH CREW STA	.2	1043.0	-24.5	-11.9

3.2-85

SNA-B-D-027(III) REV 3

TABLE 3.2-9.2 (CONTINUED)

Amendment 114
9/15/71

MISSION J-2 TRANSFERRED CREW AND EQUIPMENT STORAGE LIST								
ITEMS REARRANGED IN CM PRIOR TO PRE-CSM AT EVA (24)								
APPLIED COORDINATES								
DESCRIPTION	STOW. ITEM	REF	NO.	STORAGE LOCATION	WEIGHT	X-C.G.	Y-C.G.	Z-C.G.
POCKET, SCISSORS (CDR)	B0218.	111	1	04 PGA CT CREW STA	.2	1043.0	.0	-11.9
POCKET, SCISSORS (LMP)	B0218.	111	1	04 PGA RH CREW STA	.2	1043.0	24.5	-11.9
POCKET, CHECKLIST (CDR)	B0219.	111	1	04 PGA CT CREW STA	.2	1043.0	.0	-11.9
POCKET, CHECKLIST (LMP)	B0219.	111	1	04 PGA RH CREW STA	.2	1043.0	24.5	-11.9
POCKET, DATA (CDR)	B0220.	111	1	04 PGA CT CREW STA	.2	1043.0	.0	-11.9
POCKET, DATA (LMP)	B0220.	111	1	04 PGA RH CREW STA	.2	1043.0	24.5	-11.9
POCKET, CHECKLIST (CMP)	B0221.	111	1	04 PGA LH CREW STA	.2	1043.0	-24.5	-11.9
POCKET, DATA (CMP)	B0222.	111	1	04 PGA LH CREW STA	.2	1043.0	-24.5	-11.9
HEADSET, LIGHTWEIGHT	E0111.	111	1	AREA A8	.4	1011.0	21.0	-23.0
HEADSET, LIGHTWEIGHT	E0112.	111	1	AREA A8	.4	1011.0	21.0	-23.0
HEADSET, LIGHTWEIGHT	E0113.	111	1	AREA A8	.4	1011.0	21.0	-23.0
EARTUBE, UNIVERSAL (CMP)	E0114.	111	1	AREA U2	NEGL	1033.0	-23.0	-50.0
EARTUBE, UNIVERSAL (CDR)	E0115.	111	1	AREA U2	NEGL	1033.0	-23.0	-50.0
EARTUBE, UNIVERSAL (LMP)	E0116.	111	1	AREA U2	NEGL	1033.0	-23.0	-50.0
CM EQUIP. REDUC.					172.80	1042.01	-.93	-14.85

3.2-86

SMA-8-0-027(III) REV 3

U
S
A
F
E
M
A
R
I
T
I
M
E
S
P
A
C
E
S
H
I
P
S
A
N
D
A
I
R
C
R
A
F
T
S

TABLE 3.2-9.2 (CONTINUED)

Amendment 114
9/15/71

MISSION J-2 TRANSFERRED CREW AND EQUIPMENT STORAGE LIST								
ITEMS TRANSFERRED FROM SM TO CM DURING SIM EVA (25)							APDLG COORDINATES	
DESCRIPTION	STOW. ITEM	REF	NO.	STORAGE LOCATION	WEIGHT	X-C.G.	Y-C.G.	Z-C.G.
MAGAZINE, 24 IN. PAN. CAMERA	P0400.	111	1	IN SIM BAY (24 IN)	72.0	885.3	51.8	-48.3
MAGAZINE, 3 IN. MAP. CAMERA	P0401.	111	1	IN SIM BAY (3 IN)	22.3	947.1	55.4	-55.3
EQUIP. XFR. SM-CM					94.30	899.91	52.65	-49.96

3.2-87

SMA-8-D-027(111) REV 3

TABLE 3.2-9.2 (CONTINUED)

Amendment 114
9/15/71

MISSION J-2 TRANSFERRED CREW AND EQUIPMENT STORAGE LIST								
ITEMS TRANSFERRED FROM SM TO CM DURING SIM EVA (26)								
APOLLO COORDINATES								
DESCRIPTION	STOW. ITEM	REF.	NO.	STORAGE LOCATION	WEIGHT	X-C.G.	Y-C.G.	Z-C.G.
MAGAZINE, 24 IN. PAN. CAMERA	P3400.	111	1	AREA A2	72.0	1011.0	-27.0	8.0
MAGAZINE, 3 IN. MAP. CAMERA	P3401.	111	1	BAG, REF. USE, EQUIP (A1)	22.3	1050.0	-27.0	39.0
EQUIP. XFR. SM-CM					94.30	1020.22	-23.18	15.33

3.2-88

SMA-8-D-027(111) REV 3

U
S
N
A
S
P
A
C
E
A
D
M
I
N
I
S
T
R
A
T
I
O
N

TABLE 3.2-9.2 (CONTINUED)

Amendment 114
9/15/71

MISSION J-2 TRANSFERRED CREW AND EQUIPMENT STORAGE LIST								
ITEMS OFFLOADED FROM CSM POST SIM EVA (27)								
APOLLO COORDINATES								
DESCRIPTION	STOW. ITEM	REF	NO.	STORAGE LOCATION	WEIGHT	X-C.G.	Y-C.G.	Z-C.G.
BAG, JETTISON STORAGE ITEMS, FOOD + HYGIENE	B9147.	111	2	AREA A2	1.8	1011.0	-22.0	3.0
	C0130.	111	1	AREA B1	30.8	1050.0	-27.0	39.0
EVA OFFLOAD :					32.60	1047.85	-26.77	37.29

3.2-89

SMA-8-D-027(111) REV 3

U
N
I
T
E
D
S
T
A
T
E
S
O
F
A
M
E
R
I
C
A

TABLE 3.2.2-9.2 (CONTINUED)

Amendment 114
9/15/71

MISSION J-2 TRANSFERRED CREW AND EQUIPMENT STOWAGE LIST								
ITEMS REARRANGED IN CM PRIOR TO ENTRY (28)								
APOLLO COORDINATES								
DESCRIPTION	STOW. ITEM	REF	NO.	STOWAGE LOCATION	WEIGHT	X-C.G.	Y-C.G.	Z-C.G.
BAG, MOTION SICKNESS	A0208.	111	1	JN CREW	.1	1043.0	.0	-21.0
BAG, MOTION SICKNESS	A0208.	111	1	JN CREW	.1	1043.0	.0	-21.0
BAG, MOTION SICKNESS	A0208.	111	1	JN CREW	.1	1043.0	.0	-21.0
ACCESSORY BAG	B0105.1	111	1	IN HSB (U2)	.3	1033.0	-23.0	-50.0
ACCESSORY BAG	B0105.1	111	1	IN HSB (U2)	.3	1033.0	-23.0	-50.0
ACCESSORY BAG	B0105.1	111	1	IN HSB (U2)	.3	1033.0	-23.0	-50.0
JACKET ASSY, ICG	B0112.1	111	1	AREA U2	1.8	1033.0	-23.0	-50.0
JACKET ASSY, ICG	B0112.1	111	1	AREA U2	1.8	1033.0	-23.0	-50.0
JACKET ASSY, ICG	B0112.1	111	1	AREA U2	1.8	1033.0	-23.0	-50.0
TROUSER ASSY, ICG	B0112.2	111	1	AREA U2	1.8	1033.0	-23.0	-50.0
TROUSER ASSY, ICG	B0112.2	111	1	AREA U2	1.8	1033.0	-23.0	-50.0
TROUSER ASSY, ICG	B0112.2	111	1	AREA U2	1.8	1033.0	-23.0	-50.0
BOOT, RIGHT, ICG	B0112.3	111	1	AREA U2	.4	1033.0	-23.0	-50.0
BOOT, RIGHT, ICG	B0112.3	111	1	AREA U2	.4	1033.0	-23.0	-50.0
BOOT, RIGHT, ICG	B0112.3	111	1	AREA U2	.4	1033.0	-23.0	-50.0
BOOT, LEFT, ICG	B0112.4	111	1	AREA U2	.4	1033.0	-23.0	-50.0
BOOT, LEFT, ICG	B0112.4	111	1	AREA U2	.4	1033.0	-23.0	-50.0
BOOT, LEFT, ICG	B0112.4	111	1	AREA U2	.4	1033.0	-23.0	-50.0
BOOT, LEFT, ICG	B0112.4	111	1	AREA U2	.4	1033.0	-23.0	-50.0
SUBSYSTEM, FECAL CONTAINMENT	B0113.	111	1	JN CREW LH STA	.3	1043.0	-24.5	-11.9
PAD, HEADREST	B0130.	117	1	AREA A2	1.1	1011.0	-22.0	8.0
PAD, HEADREST	B0130.	117	1	AREA A2	1.1	1011.0	-22.0	8.0
PAD, HEADREST	B0130.	117	1	AREA A2	1.1	1011.0	-22.0	8.0
HEEL RESTRAINT, L.H. AND R.H.	B0132.	117	1	AREA A2	1.2	1011.0	-22.0	8.0
HEEL RESTRAINT, L.H. AND R.H.	B0132.	117	1	AREA A2	1.2	1011.0	-22.0	8.0
HEEL RESTRAINT, L.H. AND R.H.	B0132.	117	1	AREA A2	1.2	1011.0	-22.0	8.0
GLOVES, EV-(CMPI)	B0150.	111	1	AREA A2	2.7	1011.0	-22.0	8.0
VEST, JUAL LIFE	B0202.	111	1	IN HSB (U2)	2.4	1033.0	-23.0	-50.0
VEST, JUAL LIFE	B0202.	111	1	IN HSB (U2)	2.4	1033.0	-23.0	-50.0
VEST, JUAL LIFE	B0202.	111	1	IN HSB (U2)	2.4	1033.0	-23.0	-50.0
PGA CONTAINER	B0300.	111	1	JN AFT BULKHEAD	7.7	1015.0	.0	-19.9
ITLSA - EV	B0211.	111	1	JN CREW RH STA	46.9	1043.0	24.5	-11.9

3.2-90

SNA-8-D-027(III) REV 3

U
S
N
A
V
Y
A
S
S
E
S
S
M
E
N
T
N
O
.

TABLE 3.2-9.2 (CONTINUED)

Amendment 114
9/15/71

MISSION J-2 TRANSFERRED CREW AND EQUIPMENT STOWAGE LIST								
ITEMS REARRANGED IN CM PRIOR TO ENTRY (28)								
APOLLO COORDINATES								
DESCRIPTION	STOW. ITEM	REF	NO.	STOWAGE LOCATION	WEIGHT	X-C.G.	Y-C.G.	Z-C.G.
ITLSA - CV	B0211.	111	1	JN CREW CTR STA	46.9	1043.0	.0	-11.9
ITLSA - IV	B0212.	111	1	JN CREW LH STA	41.8	1043.0	-24.5	-11.9
GLOVES, IV PAIR	B0213.	111	1	JN CREW LH STA	2.0	1043.0	-24.5	-11.9
GLOVES, IV PAIR	B0213.	111	1	JN CREW RH STA	2.0	1043.0	24.5	-11.9
GLOVES, IV PAIR	B0213.	111	1	JN CREW CTR STA	2.0	1043.0	.0	-11.9
HELMET ASSY, PRESSURE	B0214.	111	1	JN CREW LH STA	2.7	1043.0	-24.5	-11.9
HELMET ASSY, PRESSURE	B0214.	111	1	JN CREW RH STA	2.7	1043.0	24.5	-11.9
HELMET ASSY, PRESSURE	B0214.	111	1	JN CREW CTR STA	2.7	1043.0	.0	-11.9
POCKET, SCISSORS (CMP)	B0218.	111	1	JN PGA LH CREW STA	.2	1043.0	-24.5	-11.9
POCKET, SCISSORS (CMP)	B0218.	111	1	JN PGA CT CREW STA	.2	1043.0	.0	-11.9
POCKET, SCISSORS (LMP)	B0218.	111	1	ON PGA RH CREW STA	.2	1043.0	24.5	-11.9
POCKET, CHECKLIST (CMP)	B0219.	111	1	JN PGA CT CREW STA	.2	1043.0	.0	-11.9
POCKET, CHECKLIST (LMP)	B0219.	111	1	ON PGA RH CREW STA	.2	1043.0	24.5	-11.9
POCKET, DATA (CDK)	B0220.	111	1	JN PGA CT CREW STA	.2	1043.0	.0	-11.9
POCKET, DATA (LMP)	B0220.	111	1	ON PGA RH CREW STA	.2	1043.0	24.5	-11.9
POCKET, CHECKLIST (CMP)	B0221.	111	1	JN PGA LH CREW STA	.2	1043.0	-24.5	-11.9
POCKET, DATA (CMP)	B0222.	111	1	ON PGA LH CREW STA	.2	1043.0	-24.5	-11.9
CAP, ELECTRICAL CONNECTOR	B0138.	111	1	PGA CONTAINER	NEGL	1015.0	.0	-3.5
BAG, M-191B EXPERIMENT	O6472.	111	1	AREA A2	1.0	1011.0	-22.0	8.0
DECON. BAG, FAK UV SPEC.	O6473.	111	1	JN AREA A2	1.0	1019.0	-22.0	8.0
M191B EXPERIMENT	CJ400.	111	1	AREA A2	8.0	1011.0	-22.0	8.0
BAG, HELMET STORAGE	H1058.	115	* 1	IN CM PGA CONTAINER	1.4	1015.0	.0	-20.0
BAG, HELMET STORAGE	H1058.	115	1	IN CM PGA CONTAINER	1.4	1015.0	.0	-20.0
LUNAR EXTRAVEHICULAR VISOR	B1014.	115	1	IN CM PGA CONTAINER	5.6	1015.0	.0	-20.0
LUNAR EXTRAVEHICULAR VISOR	B1014.	115	1	IN CM PGA CONTAINER	5.6	1015.0	.0	-20.0
GLOVES, EV (PAIR)	B1015.	111	1	IN CM PGA CONTAINER	2.9	1015.0	.0	-20.0
GLOVES, EV (PAIR)	B1015.	111	1	IN CM PGA CONTAINER	2.9	1015.0	.0	-20.0
CONTAINER, M12	U0344.	115	1	W GIRTH RING	2.7	1034.0	41.0	-21.0
WATER SYS ASSY, RETURN CONTIN.	U6444.	111	1	IN CM PGA CONTAINER	8.0	1015.0	.0	-20.0
BAG, WATER/URINE CONTIN. ASSY	U6445.	111	3	IN CM PGA CONTAINER	3.3	1015.0	.0	-20.0
RESTRAINT ASSY, SLEEP (RIGHT)	U0322.	111	1	AFT LEG (RIGHT)	3.8	1018.0	23.0	-51.0

3.2-91

SMA-B-D-027(111) REV 3

U
N
I
T
E
D
S
T
A
T
E
S
O
F
A
M
E
R
I
C
A

TABLE 3.2-9.2 (CONTINUED)

Amendment 114
9/15/71

MISSION J-2 TRANSFERRED CREW AND EQUIPMENT STORAGE LIST								
ITEMS REARRANGED IN CM PRICH TO ENTRY (28)								
DESCRIPTION	STGW. ITEM	REF	NO.	STORAGE LOCATION	WEIGHT	APCLLD COORDINATES		
						X-C.G.	Y-C.G.	Z-C.G.
RESTRAINT ASSY, SLEEP (CENTER)	00324.	111	1	AFT OFB (RIGHT)	2.7	1018.0	23.0	-51.0
SHIELD, HELMET PROTECTIVE	00121.	111	1	IN CM PGA CONTAINER	.8	1015.0	.0	-20.0
CAP, O2 HOSE SCREEN	00378.	111	3	IN CM PGA CONTAINER	.3	1015.0	.0	-20.0
BAG, SAMPLE COLLECTION	03078.	111	1	BETWEEN PGA AND A9	.6	1014.0	.0	8.0
SAMPLE COLLECTION BAG 3	04048.	111	1	BETWEEN PGA AND A9	1.2	1014.0	.0	9.0
SAMPLES IN BAG 3	N/A	115	1	BETWEEN PGA AND A9	12.0	1014.0	.0	8.0
CM EQUIP. RELUC. 5					256.80	1033.02	-2.12	-14.75

3.2-92

SNA-8-D-027(111) REV 3

U
R
N
L
I
B
R
A
R
Y

TABLE 3.2-9.3 (CONTINUED)

Amendment 114
9/15/71

MISSION J-2 TRANSFERRED CREW AND EQUIPMENT STORAGE LIST					APOLLO COORDINATES			
ITEMS REARRANGED IN CM PRIOR TO ENTRY (29)								
DESCRIPTION	STOW. ITEM	RFF	NO.	STORAGE LOCATION	WEIGHT	X-C.G.	Y-C.G.	Z-C.G.
BAG,MOTION SICKNESS	A0208.	111	1	PGA CONTAINER	.1	1015.0	.0	-3.5
BAG,MOTION SICKNESS	A0208.	111	1	PGA CONTAINER	.1	1015.0	.0	-3.5
BAG,MOTION SICKNESS	A0208.	111	1	ON RH+CTR SLEEP REST	.1	1020.0	25.0	-22.0
ACCESSORY BAG	B0105.1	111	1	PGA CONTAINER	.3	1020.0	.0	-3.5
ACCESSORY BAG	B0105.1	111	1	PGA CONTAINER	.3	1020.0	.0	-3.5
ACCESSORY BAG	B0105.1	111	1	ON RH+CTR SLEEP REST	.3	1020.0	25.0	-22.0
JACKET ASSY,ICG	B0112.1	111	1	ON CREW RH STA	1.8	1043.0	24.5	-11.9
JACKET ASSY,ICG	B0112.1	111	1	ON CREW CTR STA	1.8	1043.0	.0	-11.9
JACKET ASSY,ICG	B0112.1	111	1	ON CREW LH STA	1.8	1043.0	-24.5	-11.9
TROUSER ASSY,ICG	B0112.2	111	1	ON CREW RH STA	1.8	1043.0	24.5	-11.9
TROUSER ASSY,ICG	B0112.2	111	1	ON CREW CTR STA	1.8	1043.0	.0	-11.9
TROUSER ASSY,ICG	B0112.2	111	1	ON CREW LH STA	1.8	1043.0	-24.5	-11.9
BOOT,RIGHT,ICG	B0112.3	111	1	ON CREW RH STA	.4	1043.0	24.5	-11.9
BOOT,RIGHT,ICG	B0112.3	111	1	ON CREW CTR STA	.4	1043.0	.0	-11.9
BOOT,RIGHT,ICG	B0112.3	111	1	ON CREW LH STA	.4	1043.0	-24.5	-11.9
BOOT,LEFT,ICG	B0112.4	111	1	ON CREW RH STA	.4	1043.0	24.5	-11.9
BOOT,LEFT,ICG	B0112.4	111	1	ON CREW CTR STA	.4	1043.0	.0	-11.9
BOOT,LEFT,ICG	B0112.4	111	1	ON CREW LH STA	.4	1043.0	-24.5	-11.9
SUBSYSTEM,FECAL CONTAINMENT	B0113.	111	1	AREA A2	.3	1011.0	-22.0	8.0
PAD,HEADREST	B0130.	117	1	ON COUCH(RH CREW STA	1.1	1043.0	24.5	-10.4
PAD,HEADREST	B0130.	117	1	ON COUCH(CTR CREW STA	1.1	1043.0	.0	-10.4
PAD,HEADREST	B0130.	117	1	ON COUCH(LH CREW STA	1.1	1043.0	-24.5	-10.4
HEEL RESTRAINT,L.H. AND R.H.	B0132.	117	1	ON CREW RH STA	1.2	1043.0	24.5	-11.9
HEEL RESTRAINT,L.H. AND R.H.	B0132.	117	1	ON CREW CTR STA	1.2	1043.0	.0	-11.9
HEEL RESTRAINT,L.H. AND R.H.	B0132.	117	1	ON CREW LH STA	1.2	1043.0	-24.5	-11.9
GLOVES, EV-(CMP)	B0150.	111	1	PGA CONTAINER	2.7	1020.0	.0	-3.5
VEST,DUAL LIFE	B0202.	111	1	ON CREW	2.4	1047.2	.0	-23.4
VEST,DUAL LIFE	B0202.	111	1	ON CREW	2.4	1047.2	.0	-23.4
VEST,DUAL LIFE	B0202.	111	1	ON CREW	2.4	1047.2	.0	-23.4
PGA CONTAINER	U0300.	111	1	AFT UEB	7.7	1015.0	.0	-3.5
ITLSA - EV	B0211.	111	1	PGA CONTAINER	46.9	1015.0	.0	-3.5

3.2-93

SMA-B-D-027(III) REV 3

W
H
I
T
E
H
O
U
S
E
S
I
N
T
H
E
C
O
U
N
T
R
Y
O
F
A
S
I
A

TABLE 3.2-9.2 (CONTINUED)

Amendment 114
9/15/71

MISSION J-2 TRANSFERRED CREW AND EQUIPMENT STORAGE LIST								
ITEMS REARRANGED IN CM PRIOR TO ENTRY (29)								
APOLLO COORDINATES								
DESCRIPTION	STOW. ITEM	REF	NO.	STORAGE LOCATION	WEIGHT	X-C.G.	Y-C.G.	Z-C.G.
RESTRAINT ASSY, SLEEP (CENTER)	U0324.	111	1	ON TOP OF AREA A8	2.7	1020.0	25.0	-8.0
SHIELD, HELMET PROTECTIVE	B0121.	111	1	PGA CONTAINER	.8	1015.0	.0	-3.5
CAP, O2 FUSE SCREEN	U0378.	111	3	PGA CONTAINER	.3	1015.0	.0	-3.5
BAG, SAMPLE COLLECTION	U3078.	111	1	IN PGA CONTAINER	.6	1020.0	.0	8.0
SAMPLE COLLECTION BAG 3	G4048.	111	1	IN PGA CONTAINER	1.2	1020.0	.0	8.0
SAMPLES IN BAG 3	N/A	115	1	IN PGA CONTAINER	12.9	1020.0	.0	8.0
CM EQUIP. RELUC. 5					256.80	1020.69	6.30	-7.00

3.2-95

SMA-8-D-027(111) REV 3

CONSUMABLES LOADING REQUIREMENTS AND TOLERANCES

MISSION J-2
SPS PROPELLANT

Pressure (PSIA)		Temperature (°F)		Quantity Readout (%)	
Fuel	Oxidizer	Fuel	Oxidizer	Fuel	Oxidizer
110±4	110±4	70±5	70±5	See Figure 4.1-3	See Figure 4.1-4

SPS Propellant Load (lb)	Loading Requirement		Actual	
	Fuel	Oxidizer	Fuel	Oxidizer
¹ Load	15704.0	25092.0		
² Trapped Outside Tanks Tanked	78.6	123.7		
² Trapped Inside Tanks	15625.4	24968.3		
³ Nominal Deliverable	67.6	171.5		
	15557.8	24796.8		

⁴Service Module RCS Propellant

Secondary Fuel - Quads A, B, C, D - See Loading Window - Figure 4.3-1.

Primary Fuel - Quads A, B, C, D - See Loading Window - Figure 4.3-2.

Primary and Secondary Oxidizer - Quads A, B, C, D - See Loading Window - Figure 4.3-3.

⁵Command Module RCS Propellant

Fuel - System A and B - See Loading Window - Figure 4.3-4.

Oxidizer - System A and B - See Loading Window - Figure 4.3-5.

⁹Helium and Nitrogen

Consumable	Loading Requirement			Earth Launch Weight (lb)	Actual	
	Pressure (PSIA)	Temp (°F)	Weight (lb)		Pressure (PSIA)	Temp (°F)
Helium - SPS Bottles	3600	70	87.6	87.6		
Helium - Fuel Tanks	178	70	5.4	6.0		
Helium - N ₂ O ₄ Tanks	178	70				
Helium - SM/RCS Quads A	4150	70				
Helium - SM/RCS Quads B	4150	70				
Helium - SM/RCS Quads C	4150	70	1.0	1.0		
Helium - SM/RCS Quads D	4150	70				
Helium - CM/RCS System A	4150	70	1.3	1.3		
Helium - CM/RCS System B	4150	70				
Nitrogen - SM Primary	2500	85	1.3	1.3		
Nitrogen - SM Secondary	2500	85				



MISSION J-2

Command Module Water and GOX

	Pressure (PSIA)	Loading Requirement Weight (lb)	Earth Launch Weight (lb)	Actual
Waste Water ⁶			35.0	
Potable Water ⁷			30.0	
CM/GOX	900±50	3.7	6.7 (Entry)	

⁸Service Module Hydrogen and Oxygen

	Loading Req. Per Tank (pounds)	Earth Launch Weight Per Tank (lb)	Actual Per Tank (lb)
Hydrogen			
Tank 1	29.3	27.6	
Tank 2	29.3	27.6	
Tank 3	29.3	27.6	
Oxygen			
Tank 1	330.1	316.6	
Tank 2	330.1	316.6	
Tank 3	330.1	316.6	

NOTES:

- ¹Indicated propellant load is based on nominal pressure and temperature prior to actual loading. This number will be updated after loading is accomplished.
- ²See Section 4.1 for explanation of trapped SPS propellant.
- ³See Table 3.2-13 for loading uncertainties.
- ⁴See Section 4.2 for SM/RCS loads and uncertainties to be used in Mission Planning. Actual SM/RCS loads and uncertainties will be published in Table 3.2-15.
- ⁵See Section 4.2 for CM/RCS loads and uncertainties to be used in Mission Planning. Actual CM/RCS loads and uncertainties will be published in Table 3.2-14.
- ⁶Launch Rule Redlines determine lift-off values.
- ⁷Launch Rule Redlines determine lift-off values.
- ⁸Launch Mission Rules will determine minimum lift-off quantities for H₂ and O₂.
- ⁹CSM helium and nitrogen should be loaded in accordance with loading windows contained in CSM/LM Spacecraft Operational Data Book, Volume I, Part 2, SNA-8-D-027(1) P2.



SPS PROPELLANT LOAD CALCULATION

	<u>FUEL</u>	<u>OXIDIZER</u>
1. Enter SPS Quantity Readout at 110 PSIA (Table 3.2-12 Item C - Percent)	_____	_____
2. Use Figures 4.1-3 and 4.1-4 to obtain propellant load for above quantity readout.	_____	_____
3. Nominal propellant density at loading temperature (use temperature - density graph below) (lb/ft ³)	_____	_____
4. Cubic feet of propellant (item 2 divided by item 3)	_____	_____
5. Calculated density from Table 3.2-12 item f (lb/ft ³)	_____	_____
6. Adjustment due to PUGS zero adjust (pounds)	_____	_____
7. Resulting actual propellant load (item 4 times item 5, less item 6) (pounds)	_____	_____

SPS Propellant Temperature/Density Graph
at 110±5 PSIA

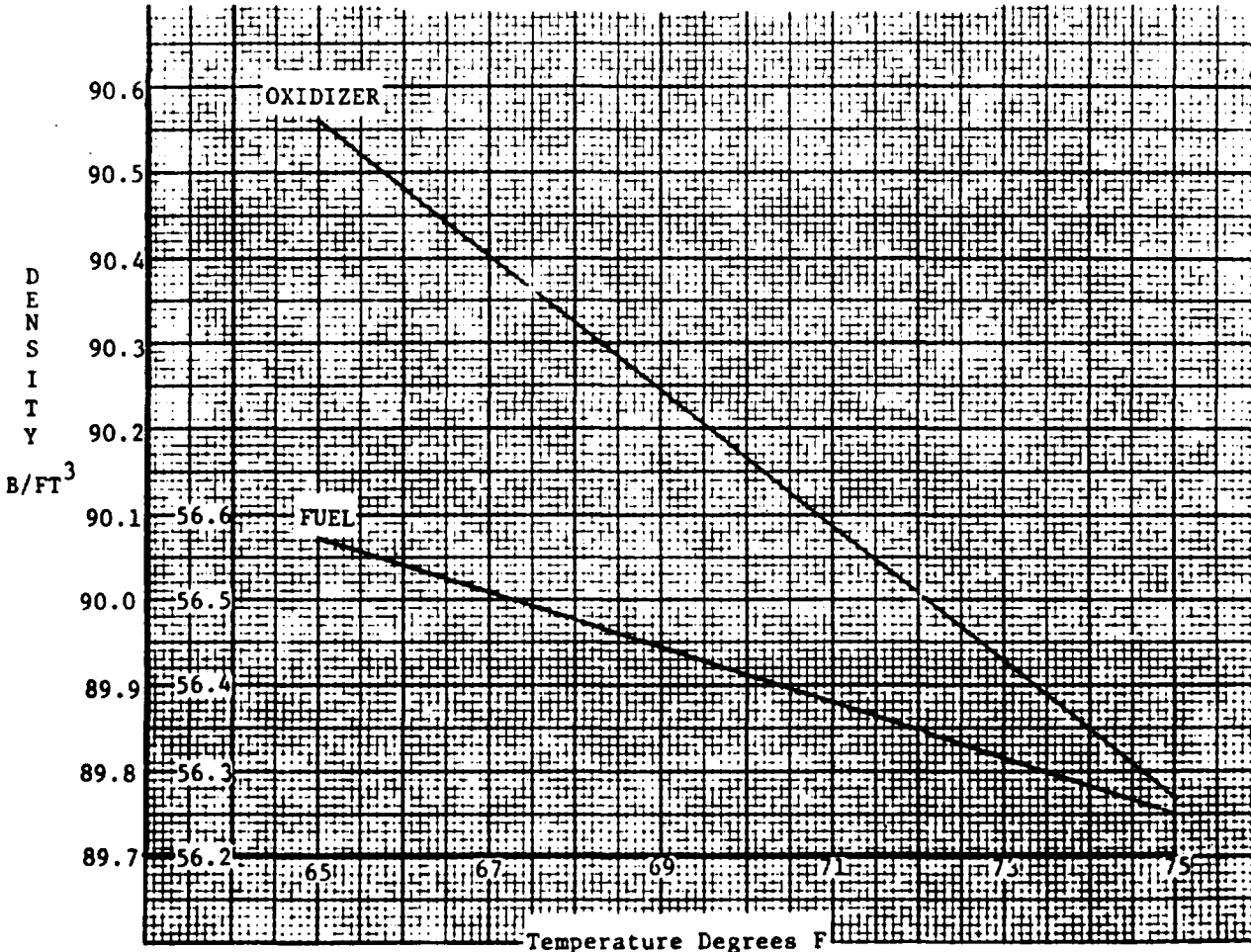

M M U U E E L L E E L L H H U U E E L L

U
N
I
T
E
D
S
T
A
T
E
S
O
F
A
M
E
R
I
C
A

TABLE 3.2-12

Amendment 114
9/15/71

MISSION J-2 SPS PROPELLANT LOAD PARAMETERS
(To be provided by KSC following loading)

Enter the following information at zero adjust - time	
<u>Fuel</u>	<u>Oxidizer</u>
Adjusted quantity fuel readout - Percent _____	Adjusted quantity oxidizer readout - Percent _____
Fuel storage voltage reading taken from _____	Oxidizer storage voltage reading taken from _____
ACE to three significant digits - volts _____	ACE to three significant digits - volts _____
Fuel sump voltage reading taken from _____	Oxidizer sump voltage reading taken from _____
ACE to three significant digits - volts _____	ACE to three significant digits - volts _____

Enter the following information at Sump Tank Full Adjust
(Propellant at top of standpipe)

<u>Fuel</u>	<u>Oxidizer</u>
Fuel sump tank pressure - PSIA _____	Oxidizer sump tank pressure - PSIA _____
Fuel temperature - °F _____	Oxidizer temperature - °F _____
Adjusted quantity fuel readout - Percent _____	Adjusted quantity oxidizer readout - % _____
Fuel sump voltage reading taken from _____	Oxidizer sump voltage reading taken from _____
ACE to three significant digits - volts _____	ACE to three significant digits - volts _____

Enter the following information at Storage Tank Full Adjust
(Propellant at Point Sensor #1)

<u>Fuel</u>	<u>Oxidizer</u>
Fuel storage tank pressure - PSIA _____	Oxidizer storage tank pressure - PSIA _____
Fuel temperature - °F _____	Oxidizer temperature - °F _____
Adjusted quantity fuel readout - % _____	Adjusted quantity oxidizer readout - % _____
Fuel storage voltage reading taken from _____	Oxidizer storage voltage reading taken from _____
ACE to three significant digits - volts _____	ACE to three significant digits - volts _____
Fuel sump voltage reading taken from _____	Oxidizer sump voltage reading taken from _____
ACE to three significant digits - volts _____	ACE to three significant digits - volts _____

3.2-99

SNA-8-D-027(III) REV 3

TABLE 3.2-12 (CONTINUED)

Amendment 114
9/15/71MISSION J-2 SPS PROPELLANT LOAD PARAMETERS
(To be provided by KSC following loading)

Enter the following information when tanking is complete (110±5 PSIA) Time	
<u>FUEL</u>	<u>OXIDIZER</u>
a. System pressure - PSIA _____	a. System pressure - PSIA _____
b. Fuel temperature - °F _____	b. Oxidizer temperature - °F _____
c. Quantity fuel readout - % _____	c. Quantity oxidizer readout - % _____
d. Fuel measured specific gravity @ 25°C - 14.7 PSIA _____	d. Oxidizer measured specific gravity @ 4°C - 14.7 PSIA _____
e. Fuel measured density 25°C - 14.7 PSIA (Item d times 62.428) - lb/ft ³ _____	e. Oxidizer measured density @ 4°C - 14.7 PSIA (Item d times 62.428) - lb/ft ³ _____
f. Calculated density - lb/ft ³ - at system pressure and temperature Items a and b above. Use density equation outlined in Section 4.1. _____	f. Calculated density - lb/ft ³ - at system pressure and temperature Items a and b above. Use density equation outlined in Section 4.1. _____
g. Fuel storage voltage reading from ACE _____	g. Oxidizer storage voltage reading from ACE _____
h. Fuel sump voltage reading from ACE _____	h. Oxidizer sump voltage reading from ACE _____

Enter the following information at leak check pressure

<u>Fuel</u>	<u>Oxidizer</u>
System pressure - PSIA _____	System pressure - PSIA _____
Quantity fuel readout - % _____	Quantity oxidizer readout - % _____
Fuel storage voltage reading from ACE _____	Oxidizer storage voltage readout from ACE _____
Fuel sump voltage reading from ACE _____	Oxidizer sump voltage readout from ACE _____

3.2-100

SNA-8-D-027(III) REV 3

SPS PROPELLANT UNCERTAINTIES

ITEM	FUEL	OXIDIZER
<u>LOADING UNCERTAINTIES</u>	(lb)	(lb)
Tank Volume	±24	±39
Temperature Gauge (±2.0°F)	±18	±46
Standpipe Height	± 6	±10
Propellant Gauge (±0.35% of Gaugeable)	±54	±86
Density Measurement (1)	± 0	± 0
Batch Density (1)	±94	±75
Loading Pressure (1)	± 8	±14
RSS	±113	±130
TOTAL RSS	±172	
Loading Specification (1) (2)	±16	±24
Tolerance on Propellant Temperature of Flight Load	+ 0 -46	+ 0 -113
TOTAL LOADING UNCERTAINTY	+212 -371	

NOTES: (1) Data will be known after loading is accomplished.

(2) Loading specification is an allowable tolerance about nominal, this number is added to the loading uncertainty variable.



MISSION J-2

COMMAND MODULE RCS LOADING PARAMETERS AND CALCULATIONS

This table will be completed when loading is accomplished. For Mission Planning, reference should be made to Section 4.2 for nominal load, loading tolerances, trapped and deliverable propellants.

	<u>FUEL</u>		<u>OXIDIZER</u>	
	<u>Tank A</u>	<u>Tank B</u>	<u>Tank A</u>	<u>Tank B</u>
A. Tank Volume @0.0 PSIA (in ³)	_____	_____	_____	_____
B. Liquid Line Volume (in ³)	_____	_____	_____	_____
C. Total A + B (in ³)	_____	_____	_____	_____
D. Initial Weight in Bleed Unit Prior to Loading (lb)	_____	_____	_____	_____
E. Final Weight in Bleed Unit After Loading (lb)	_____	_____	_____	_____
F. Propellant Load (item D less than E Weigh Tank)	_____	_____	_____	_____
G. Propellant Load by .P.V.	_____	_____	_____	_____
H. Loading Temperature (°F)	_____	_____	_____	_____
I. Specification Propellant Load @ 70±5°F (lb)	_____		_____	
J. Total CM/RCS Propellant Load from Item G above (lb)	_____		_____	
K. Maximum Trapped Propellant (lb)	_____		_____	
L. Nominal Deliverable (lb)	_____		_____	

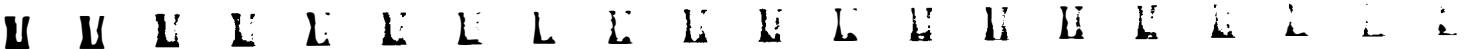

MISSION J-2

SERVICE MODULE RCS LOADING SUMMATION

This table will be completed when loading is accomplished. For Mission Planning, reference should be made to Section 4.2, for nominal load, loading tolerances, and nominal deliverable propellants.

<u>Quad A (lb)</u>		<u>Quad B (lb)</u>	
Secondary Fuel	_____	Secondary Fuel	_____
Primary Fuel	_____	Primary Fuel	_____
Total Fuel	_____	Total Fuel	_____
Maximum Trapped	_____	Maximum Trapped	_____
Nominal Deliverable	_____	Nominal Deliverable	_____
Total Oxidizer	_____	Total Oxidizer	_____
Maximum Trapped	_____	Maximum Trapped	_____
Nominal Deliverable	_____	Nominal Deliverable	_____
<u>Quad C (lb)</u>		<u>Quad D (lb)</u>	
Secondary Fuel	_____	Secondary Fuel	_____
Primary Fuel	_____	Primary Fuel	_____
Total Fuel	_____	Total Fuel	_____
Maximum Trapped	_____	Maximum Trapped	_____
Nominal Deliverable	_____	Nominal Deliverable	_____
Total Oxidizer	_____	Total Oxidizer	_____
Maximum Trapped	_____	Maximum Trapped	_____
Nominal Deliverable	_____	Nominal Deliverable	_____
<u>Total SM/RCS Propellant Load (lb)</u>			
Total Fuel	_____	Total Oxidizer	_____
Maximum Trapped	_____	Maximum Trapped	_____
Nominal Deliverable	_____	Nominal Deliverable	_____

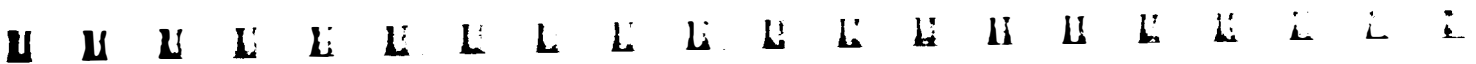

LM-11 CONSUMABLE LOADING REQUIREMENTS

LM-11 APS PROPELLANT

	<u>Fuel (lb)</u>	<u>Oxidizer (lb)</u>
Propellant Load	2014.2	3225.7
Trapped Outside Tanks	5.9	8.3
Tanked	2008.3	3217.4
Trapped Inside Tanks	10.0	27.7
Nominal Deliverable	1998.3	3189.7
Outage	TBD	TBD
Total APS Propellant	TBD	

The following table should be used to determine the amount of propellant to be off-loaded from a full condition to arrive at the indicated load. The allowable tolerance for the calculated off-load is ± 0.5 pounds per weigh tank.

A. Final tank pressure at overfill (PSIG)	_____	_____
B. Propellant loading temperature ($^{\circ}$ F)	_____	_____
C. Nominal overfill quantity (lb)	_____	_____
D. Correction for tank pressure (lb)		
Fuel = 0.09 (Item A-40)		
Oxidizer = 0.15 (Item A-40)		
¹ E. Correction for loading temperature (lb)		
Fuel = 1.16 (Item B-65)		
Oxidizer = -2.84 (Item B-65)	_____	_____
² F. Measured density (GM/CC)	_____	_____
² G. Nominal density (GM/CC)	_____	_____
H. Delta density (GM/CC) (Item F-G)	_____	_____
³ I. Correction for measured density		
Fuel = 2300 (Item H)	_____	_____
Oxidizer = 2300 (Item H)	_____	_____
J. Propellant in GSE	_____	_____
K. Overfill quantity (C+D+E+I+J)	_____	_____
L. Target loading	_____	_____
M. Quantity required to fill RCS manifolds	_____	_____
N. Quantity to be off-loaded (Item K-L-M)	_____	_____

NOTES:

¹Loading temperature correction will always be negative.

²To calculate the nominal density solve the following equation where T = temperature in $^{\circ}$ C of the measured density (usually 4° C for oxidizer and 25° C for fuel). This equation is valid for 14.7 PSIA. Therefore, the measured density must also be at 14.7 PSIA.

Nominal fuel density = $0.922904 - 0.0009377 (^{\circ}\text{C})$

Nominal oxidizer density = $1.491539 - 0.0022832 (^{\circ}\text{C})$

³Correction for measured density may be either positive or negative.



LM-11 CONSUMABLE LOADING REQUIREMENTS

LM-11 DPS PROPELLANT

	<u>Fuel (lb)</u>	<u>Oxidizer (lb)</u>
Propellant Load	<u>7526.0</u>	<u>12035.8</u>
Trapped Outside Tanks	<u>27.3</u>	<u>48.9</u>
Tanked	<u>7498.7</u>	<u>11986.9</u>
Trapped Inside Tanks	<u>13.5</u>	<u>43.3</u>
Nominal Deliverable	<u>7485.2</u>	<u>11943.6</u>
Outage	<u>TBD</u>	<u>TBD</u>
Total DPS Propellant	<u>TBD</u>	

The following table should be used to determine the amount of propellant to be off-loaded from a full condition to arrive at the indicated load. The allowable tolerance for the calculated off-load is ± 0.5 pounds per weigh tank.

A1. Final tank pressure at overfill (PSIG)	_____	_____
B1. Propellant loading temperature ($^{\circ}$ F)	_____	_____
C1. Nominal overfill quantity (lb)	_____	_____
D1. Correction for tank pressure (lb)	_____	_____
Fuel = 0.33 (Item A1 -40) Oxidizer = 0.54 (Item A1 -40)		
¹ E1. Correction for loading temperature (lb)	_____	_____
Fuel = 4.25 (Item B1 -65) Oxidizer = -10.5 (Item B1 -65)		
² F1. Measured density (GM/CC)	_____	_____
² G1. Nominal density (GM/CC)	_____	_____
H1. Delta density (GM/CC) (Item F1 - Item G1)	_____	_____
³ I1. Correction for measured density	_____	_____
Fuel = 8400 (Item H1) Oxidizer = 8400 (Item H1)		
J1. Propellant in GSE	_____	_____
K1. Overfill quantity (C1+D1+E1+I1+J1)	_____	_____
L1. Target loading	_____	_____
M1. Quantity required to fill RCS manifolds (APS only)	_____	_____
N1. Quantity to be off-loaded (Items K1-L1-M1)	_____	_____

NOTES:

¹Loading temperature correction will always be negative.

²To calculate the nominal density solve the following equation where T = temperature in $^{\circ}$ C of the measured density (usually 4° C for oxidizer and 25° C for fuel). This equation is valid for 14.7 PSIA. Therefore, the measured density must also be at 14.7 PSIA.

Nominal fuel density = $0.922904 - 0.0009377 (^{\circ}\text{C})$

Nominal oxidizer density = $1.491539 - 0.0022832 (^{\circ}\text{C})$

³Correction for measured density may be either positive or negative.

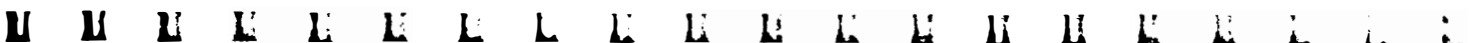

TABLE 3.2-16.1

LM-11 ECS WATER LOADING DATA

To Be Supplied.

MISSION J-2

LM-11 LOAD CALCULATION

<u>APS PROPELLANT</u>	<u>FUEL</u>	<u>OXIDIZER</u>
1. Full tank - Item K, Table 3.2-16 (lb)	_____	_____
¹ 2. Density of off-load tables at loading temperature and pressure (lb/ft ³)	_____	_____
¹ 3. Propellant volume (divide item 1 by item 2) (ft ³)	_____	_____
¹ 4. Measured density (from Table 3.2-19) (lb/ft ³)	_____	_____
5. Resulting full tank load (lb)	_____	_____
* 6. Off-load amount (lb)	_____	_____
7. Propellant required to fill RCS manifolds (lb)	_____	_____
8. Propellant load (lb)	_____	_____
 <u>DPS PROPELLANT</u>		
9. Full tank - Item K1 Table 3.2-16	_____	_____
¹ 10. Density of off-load tables at loading temperature and pressure (lb/ft ³)	_____	_____
¹ 11. Propellant volume (divide Item 9 by Item 10) (ft ³)	_____	_____
¹ 12. Measured density (from Table 3.2-19) (lb/ft ³)	_____	_____
13. Resulting full tank load (lb)	_____	_____
14. Off-load amount (lb)	_____	_____
15. Propellant load (lb)	_____	_____

<u>RCS PROPELLANT</u>	<u>Fuel</u>		<u>Oxidizer</u>	
P. V. Calculations	<u>Tank A</u>	<u>Tank B</u>	<u>Tank A</u>	<u>Tank B</u>
A. GSE Volume (in ³)	_____	_____	_____	_____
B. Initial Ullage Pressure (PSIG)	_____	_____	_____	_____
C. Initial GSE Pressure (PSIG)	_____	_____	_____	_____
D. Final GSE - S/C Pressure (PSIG)	_____	_____	_____	_____
E. Ullage Volume (in ³) - Solve the following equation by substituting the values in the indicated steps.	_____	_____	_____	_____
Ullage Volume = $\frac{(D-C)(A)}{B-D}$				

NOTE: ¹These items will be completed only if a density sample is not made prior to loading. If a density sample is made prior to loading, then the items will be left blank.



MISSION J-2

LM-11 PROPELLANT LOADING UNCERTAINTIES

LM-11 APS PROPELLANT

	<u>Fuel (lb)</u>	<u>Oxidizer (lb)</u>
Vent Line Volume	<u>±0.2</u>	<u>±0.3</u>
Tank Volume	<u>±0.8</u>	<u>±1.3</u>
Pressure Measurement (±5 PSIA)	<u>±0.5</u>	<u>±0.8</u>
Temperature Measurement (±1.5°F)	<u>±1.7</u>	<u>±4.3</u>
Measured Density	<u>±0.7</u>	<u>±0.5</u>
Weight Measurement	<u>±0.5</u>	<u>±0.5</u>
¹ Loading Tolerances	<u>±0.5</u>	<u>±0.5</u>
Total Loading Uncertainty	<u>±4.8</u>	<u>±8.2</u>

LM-11 DPS PROPELLANT

Vent Line Volume	<u>±0.2</u>	<u>±0.3</u>
Tank Volume	<u>±3.62</u>	<u>±5.96</u>
Pressure Measurement (±5 PSIA)	<u>±1.70</u>	<u>±2.77</u>
Temperature Measurement (1.5°F)	<u>±6.49</u>	<u>±15.76</u>
Measured Density	<u>±2.55</u>	<u>±1.70</u>
Weight Measurement	<u>±0.5</u>	<u>±0.5</u>
¹ Loading Tolerance	<u>±0.5</u>	<u>±0.5</u>
Total Loading Uncertainty	<u>±15.6</u>	<u>±27.5</u>

LM-11 RCS PROPELLANT

Loading Temperature	<u>±0.6</u>	<u>±1.8</u>
Ullage Calculation	<u>±0.4</u>	<u>±0.6</u>
Tank and Manifold Volume	<u>±0.8</u>	<u>±1.4</u>
Total	<u>±1.8</u>	<u>±3.8</u>

¹These will be known quantities after loading is accomplished.



TABLE 3.2-19
MISSION J-2

Amendment 114
9/15/71

LM-11 APS PROPELLANT LOADING PARAMETERS
(To Be Completed by KSC at Loading)

	<u>Fuel</u>	<u>Oxidizer</u>
Loading Pressure - PSIA	_____	_____
Loading Temperature - Fill Line - Degrees F	{ TT 58 Fuel TT258 Oxidizer	_____
Loading Temperature - Return Line - Degrees F	{ TT 59 Fuel TT259 Oxidizer	_____
Loading Temperature - Tank - Degrees F	{ GP0718 Fuel GP1218 Oxidizer	_____
Number of Times Weigh Tank Used (Flow Meter Not Used)	_____	_____
Total Pounds Off-Loaded Using Weigh Tank (Flow Meter Not Used)	_____	_____
Pounds Off-Loaded Using Flow Meter (Weight Tank Not Used)	_____	_____
Measured Fuel Density @ 25°C; @ 14.7 PSIA GM/CC	_____	_____
Measured Oxidizer Density @ 4°C; 14.7 PSIA GM/CC	_____	_____



TABLE 3.2-19 (CONTINUED)

Amendment 114
9/15/71

MISSION J-2

LM-11 DPS PROPELLANT LOADING PARAMETERS

	<u>Fuel</u>	<u>Oxidizer</u>
Loading Pressure - PSIA	_____	_____
Loading Temperature - Fill Line - Degrees F	<div style="display: flex; align-items: center;"> TT 58 Fuel TT258 Oxidizer </div>	
Loading Temperature - Return Line - Degrees F	<div style="display: flex; align-items: center;"> TT 59 Fuel TT259 Oxidizer </div>	
Loading Temperature - Tank One - Degrees F	<div style="display: flex; align-items: center;"> GQ3718 Fuel GQ4218 Oxidizer </div>	
Loading Temperature - Tank Two - Degrees F	<div style="display: flex; align-items: center;"> GQ3719 Fuel GQ4219 Oxidizer </div>	
Number of Times Weigh Tank Used (Flow Meter Not Used)	_____	_____
Total Pounds Off-Loaded Using Weight Tank (Flow Meter Not Used)	_____	_____
Pounds Off-Loaded Using Flow Meter (Weigh Tank Not Used)	_____	_____
Measured Fuel Density @ 25°C; @ 14.7 PSIA GM/CC	_____	_____
Measured Oxidizer Density @ 4°C; @ 14.7 PSIA GM/CC	_____	_____

U U

- Table 3.2-20 presents the CSM-113/LM-11(docked) mass properties, in Apollo coordinates, as a function of spacecraft weight for L.O.I. SM/SPS burn.
- Table 3.2-21 presents the CSM-113/LM-11(docked) mass properties, in Apollo coordinates, as a function of spacecraft weight for the D.O.I. SM/SPS burn.
- Table 3.2-22 presents the CSM-113 mass properties, in Apollo coordinates, as a function of CSM weight for the Circularization I SM/SPS burn.
- Table 3.2-23 presents the CSM-113 mass properties, in Apollo coordinates, as a function of CSM weight for the Plane Change I SM/SPS burn.
- Table 3.2-24 presents the CSM-113 mass properties, in Apollo coordinates as a function of CSM weight for the T.E.I. SM/SPS burn.
- Table 3.2-25 presents the LM-11 mass properties, in LM coordinates, as a function of LM weight for the P.D.I. DPS burn.
- Table 3.2-26 presents the LM-11 ascent stage mass properties, in LM coordinates, as a function of weight for the lunar liftoff APS burn.
- Table 3.2-27 presents the LM-11 mass properties, in LM coordinates, as a function of LM weight for the T.P.I. to docking LM/APS burn.



X(A) COORDINATES TABLE 3.2-20 CSM-113/LM-11 L.O.I. BURN

WEIGHT LBS.	X-BAR	Y-BAR INCHES	Z-BAR	IXX	IYY	IZZ SLUG-FT SQ	PXY	PXZ	PYZ	PITCH DEGREES	YAW DEGREES	AVERAGE MOMENT	INERTIA/THRUST RATIO
102838.3	1041.01	3.00	3.43	62051	574768	577523	-11054	-5609	2010	1.204	-.124	576146	1.574
101838.3	1041.76	2.99	3.36	61527	573060	576250	-11047	-5484	1864	1.228	-.128	574655	1.565
100838.3	1042.59	2.99	3.28	61002	571056	574681	-11039	-5343	1719	1.252	-.132	572869	1.553
99838.3	1043.52	2.99	3.20	60477	568729	572789	-11031	-5187	1574	1.277	-.137	570759	1.541
98838.3	1044.54	2.98	3.12	59952	566050	570540	-11021	-5015	1429	1.303	-.142	568298	1.527
97838.3	1045.66	2.98	3.04	59427	562987	567910	-11011	-4827	1283	1.329	-.147	565452	1.511
96838.3	1046.87	2.97	2.96	58901	559506	564874	-11000	-4622	1138	1.356	-.153	562190	1.494
95838.3	1048.19	2.97	2.88	58375	555574	561378	-10988	-4400	992	1.383	-.159	558476	1.475
94838.3	1049.61	2.96	2.79	57849	551151	557392	-10975	-4161	847	1.411	-.165	554271	1.454
93838.3	1051.14	2.96	2.70	57322	546199	552876	-10961	-3903	702	1.439	-.172	549538	1.432
92838.3	1052.78	2.95	2.62	56795	540675	547790	-10946	-3626	556	1.468	-.179	544232	1.407
91838.3	1054.54	2.95	2.52	56268	534534	542087	-10929	-3330	411	1.497	-.187	538311	1.381
90838.3	1056.42	2.94	2.43	55740	527730	535720	-10912	-3013	265	1.526	-.194	531725	1.353
89838.3	1058.42	2.94	2.34	55213	520211	528640	-10894	-2676	120	1.556	-.202	524426	1.322
88838.3	1060.55	2.93	2.24	54684	511926	520793	-10874	-2317	-25	1.586	-.211	516359	1.290
87838.3	1062.82	2.93	2.14	54156	502814	512120	-10853	-1935	-170	1.616	-.219	507467	1.255
86838.3	1065.21	2.92	2.04	53627	492878	502623	-10831	-1532	-316	1.647	-.228	497750	1.218
85838.3	1067.76	2.92	1.93	53097	481934	492119	-10808	-1103	-461	1.678	-.237	487027	1.179
84833.3	1069.70	2.86	1.89	52582	474825	485012	-10712	-911	-568	1.693	-.257	479919	1.152
83838.3	1070.90	2.76	1.84	52081	472660	482364	-10533	-920	-633	1.694	-.284	477512	1.141
82838.3	1072.21	2.66	1.90	51580	470090	479311	-10336	-929	-697	1.695	-.312	474700	1.128
81838.3	1073.63	2.56	1.90	51078	467124	475862	-10122	-939	-762	1.697	-.340	471493	1.113
80838.3	1075.17	2.45	1.91	50577	463764	472018	-9891	-949	-826	1.699	-.369	467891	1.098
79838.3	1076.81	2.34	1.91	50074	460002	467771	-9643	-960	-891	1.701	-.399	463887	1.081
78838.3	1078.57	2.23	1.92	49572	455823	463108	-9379	-972	-955	1.703	-.429	459465	1.063
77838.3	1080.44	2.12	1.92	49069	451203	458003	-9098	-985	-1020	1.705	-.459	454603	1.044
76838.3	1082.43	2.00	1.93	48565	446112	452426	-8798	-999	-1084	1.707	-.490	449269	1.024
75838.3	1084.54	1.88	1.93	48061	440512	446340	-8480	-1013	-1148	1.710	-.521	443426	1.002
74838.3	1086.79	1.76	1.94	47557	434361	439703	-8142	-1029	-1213	1.712	-.553	437032	.979
73838.3	1089.17	1.63	1.94	47052	427610	432464	-7783	-1045	-1277	1.715	-.585	430037	.954
72838.3	1091.70	1.50	1.95	46546	420206	424572	-7402	-1062	-1341	1.718	-.617	422389	.928
71838.3	1094.39	1.37	1.95	46040	412094	415973	-6998	-1081	-1405	1.721	-.650	414034	.900
70838.3	1097.23	1.23	1.96	45534	403220	406609	-6569	-1100	-1470	1.725	-.683	404915	.871
69838.3	1100.25	1.09	1.97	45027	393526	396427	-6114	-1121	-1534	1.728	-.716	394976	.840
68838.3	1103.44	.94	1.97	44519	382961	385372	-5632	-1142	-1598	1.732	-.750	384167	.807
67838.3	1106.82	.79	1.98	44010	371478	373398	-5122	-1165	-1662	1.735	-.784	372438	.773
66838.3	1110.39	.64	1.99	43501	359036	360465	-4584	-1184	-1726	1.739	-.818	359751	.737

3.2-113 SMA-8-D-027(III) REV 3

X(A) COORDINATES			TABLE 3.2-20 (CONTINUED)							CSM-113/LM-11 L.O.I. BURN			
WEIGHT LBS.	X-BAR	Y-BAR INCHES	Z-BAR	IXX	IYY	IZZ SLUG-FT ² SU	PXY	PXZ	PYZ	PITCH DEGREES	YAW DEGREES	AVERAGE MOMENT	INERTIA/THRUST RATIO
65838.3	1114.15	.48	1.99	42991	345559	346496	-4020	-1215	-1790	1.743	-.852	346028	.699
64838.3	1118.13	.32	2.00	42481	330976	331421	-3416	-1242	-1855	1.747	-.886	331198	.667
63838.3	1122.33	.15	2.01	41969	315215	315166	-2782	-1270	-1919	1.752	-.921	315191	.619
62838.3	1126.79	-.03	2.02	41457	298064	297461	-2108	-1301	-1983	1.756	-.955	297732	.576

3.2-114

SMA-8-D-027(III)REV 3

X(A) COORDINATES

TABLE 3.2-21

CSM-113/LM-11 D.O.I. BURN

WEIGHT LBS.	X-BAR	Y-BAR INCHES	Z-BAR	IXX	IYY	IZZ	PXY	PXZ	PYZ	PITCH DEGREES	YAW	AVERAGE MOMENT	INERTIA/THRUST RATIO
102787.4	1041.07	3.00	3.43	62003	574612	577374	-11063	-5605	2022	1.205	-.123	575993	1.573
101787.4	1041.31	3.00	3.36	61478	572902	576094	-11056	-5479	1877	1.229	-.127	574500	1.564
100787.4	1042.65	2.99	3.28	60954	570896	574528	-11048	-5339	1731	1.253	-.131	572712	1.553
99787.4	1043.57	2.99	3.20	60429	568567	572634	-11040	-5182	1586	1.278	-.136	570601	1.540
98787.4	1044.60	2.98	3.12	59904	565885	570388	-11030	-5010	1441	1.304	-.141	568137	1.526
97787.4	1045.71	2.98	3.04	59378	562820	567758	-11020	-4822	1295	1.330	-.147	565289	1.510
96787.4	1046.93	2.98	2.96	58853	559336	564711	-11009	-4617	1150	1.356	-.152	562023	1.493
95787.4	1048.25	2.97	2.88	58327	555400	561211	-10997	-4395	1005	1.384	-.158	558306	1.474
94787.4	1049.67	2.97	2.79	57800	550974	557222	-10984	-4155	859	1.411	-.165	554098	1.453
93787.4	1051.20	2.96	2.70	57274	546018	552702	-10970	-3897	714	1.439	-.172	549360	1.431
92787.4	1052.85	2.96	2.61	56747	540490	547611	-10955	-3621	568	1.468	-.179	544051	1.406
91787.4	1054.61	2.95	2.52	56220	534345	541904	-10939	-3324	423	1.497	-.186	538124	1.380
90787.4	1056.44	2.95	2.43	55692	527536	535532	-10922	-3008	277	1.527	-.194	531534	1.352
89787.4	1058.43	2.94	2.33	55164	520012	528447	-10903	-2670	132	1.556	-.202	524229	1.321
88787.4	1060.62	2.94	2.24	54636	511720	520594	-10884	-2311	-13	1.587	-.210	516157	1.289
87787.4	1062.89	2.93	2.14	54107	502602	511915	-10863	-1928	-158	1.617	-.219	507258	1.254
86787.4	1065.29	2.93	2.03	53578	492659	502411	-10841	-1525	-304	1.648	-.228	497535	1.217
85787.4	1067.84	2.92	1.93	53049	481708	491900	-10818	-1096	-449	1.679	-.237	486804	1.178
84787.4	1069.78	2.86	1.89	52533	474593	484787	-10722	-904	-556	1.693	-.256	479690	1.151
83787.4	1070.38	2.77	1.89	52033	472424	482136	-10543	-913	-621	1.695	-.283	477280	1.140
82787.4	1072.30	2.67	1.89	51532	469850	479078	-10346	-922	-685	1.696	-.311	474464	1.127
81787.4	1073.72	2.56	1.90	51030	466880	475625	-10132	-932	-750	1.698	-.340	471253	1.113
80787.4	1075.26	2.46	1.90	50528	463515	471776	-9901	-942	-814	1.699	-.369	467646	1.097
79787.4	1076.90	2.35	1.91	50026	459748	467525	-9654	-953	-879	1.701	-.398	463637	1.080
78787.4	1078.66	2.24	1.91	49524	455564	462855	-9384	-965	-943	1.703	-.428	459210	1.062
77787.4	1080.53	2.12	1.92	49021	450938	457745	-9107	-978	-1007	1.706	-.458	454341	1.043
76787.4	1082.52	2.01	1.92	48517	445841	452162	-8808	-991	-1072	1.708	-.489	449001	1.023
75787.4	1084.64	1.89	1.93	48013	440234	446069	-8490	-1006	-1136	1.710	-.520	443152	1.001
74787.4	1086.89	1.76	1.93	47509	434076	439424	-8151	-1021	-1201	1.713	-.552	436750	.978
73787.4	1089.28	1.64	1.94	47004	427316	432177	-7792	-1037	-1265	1.716	-.584	429747	.953
72787.4	1091.81	1.51	1.95	46498	419904	424277	-7411	-1054	-1329	1.719	-.616	422090	.927
71787.4	1094.50	1.37	1.95	45992	411783	415668	-7007	-1073	-1393	1.722	-.649	413726	.899
70787.4	1097.35	1.23	1.96	45486	402898	406295	-6578	-1092	-1458	1.725	-.682	404596	.870
69787.4	1100.37	1.09	1.96	44978	393194	396101	-6123	-1112	-1522	1.729	-.716	394648	.839
68787.4	1103.57	.95	1.97	44471	382617	385035	-5641	-1134	-1586	1.732	-.749	383826	.806
67787.4	1106.95	.60	1.98	43962	371121	373048	-5131	-1157	-1650	1.736	-.783	372085	.772
66787.4	1110.52	.64	1.98	43453	358666	360102	-4593	-1181	-1714	1.740	-.817	359384	.736

3.2-115

SMA-B-D-027(III) REV 3

Amendment 114
9/15/71

X(A) COORDINATES

TABLE 3.2-21 (CONTINUED)

CSM-113/LM-11 D.O.I. BURN

WEIGHT LBS.	X-BAR	Y-BAR INCHES	Z-BAR	IXX	IYY	IZZ SLUG-FT SQ	PXY	PXZ	PYZ	PITCH DEGREES	YAW	AVERAGE MOMENT	INERTIA/THRUST RATIO
65787.4	1114.29	.48	1.99	42943	345174	346118	-4029	-1207	-1778	1.744	-.851	345646	.699
64787.4	1116.27	.32	2.00	42433	330576	331027	-3425	-1233	-1843	1.748	-.986	330801	.659
63787.4	1122.48	.15	2.01	41921	314797	314755	-2790	-1262	-1907	1.753	-.920	314776	.618
62787.4	1126.35	-.02	2.01	41409	297568	297031	-2116	-1292	-1971	1.757	-.955	297300	.575

3.2-116

SMA-8-D-027 (III) REV 3

X(A) COORDINATES

TABLE 3.2-22

CSM-113 CIRCULARIZATION BURN

WEIGHT LBS.	X-BAR	Y-BAR INCHES	Z-BAR	IXX	IYY	IZZ SLUG-FT SQ	PXY	PXZ	PYZ	PITCH DEGREES	YAW	AVERAGE MOMENT	INERTIA/THRUST RATIO
65918.0	933.15	4.91	4.97	35732	78462	80188	-2167	477	2474	-.695	1.861	79325	.451
64918.0	932.65	4.93	4.87	35212	77789	79944	-2156	436	2331	-.656	1.888	78866	.450
63918.0	932.26	4.95	4.78	34691	77198	79784	-2147	403	2188	-.611	1.913	78491	.450
62918.0	931.98	4.98	4.68	34170	76671	79687	-2141	379	2046	-.562	1.936	78179	.449
61918.0	931.81	5.00	4.58	33649	76189	79635	-2137	365	1904	-.508	1.955	77912	.449
60918.0	931.75	5.03	4.47	33128	75730	79607	-2136	361	1761	-.448	1.972	77668	.447
59918.0	931.81	5.06	4.36	32606	75272	79580	-2137	367	1619	-.383	1.986	77426	.446
58918.0	932.00	5.09	4.25	32084	74791	79531	-2141	384	1477	-.313	1.997	77161	.443
57918.0	932.33	5.12	4.13	31561	74264	79435	-2147	412	1335	-.238	2.004	76849	.440
56918.0	932.79	5.15	4.01	31039	73662	79265	-2157	453	1192	-.158	2.008	76463	.436
55918.0	933.40	5.18	3.89	30515	72957	78993	-2170	506	1051	-.073	2.007	75975	.431
54918.0	934.16	5.21	3.76	29992	72119	78587	-2186	573	909	.017	2.003	75353	.424
53918.0	935.10	5.24	3.63	29468	71114	78016	-2205	654	767	.112	1.995	74565	.416
52918.0	936.20	5.28	3.49	28943	69907	77242	-2229	750	625	.212	1.983	73574	.406
51918.0	937.49	5.31	3.34	28418	68459	76228	-2256	862	484	.315	1.966	72343	.394
50918.0	938.98	5.35	3.19	27893	66724	74927	-2287	992	342	.422	1.945	70826	.380
49918.0	940.67	5.39	3.03	27367	64678	73316	-2323	1137	201	.532	1.921	68997	.365
48918.0	942.60	5.43	2.87	26840	62229	71303	-2364	1304	60	.646	1.892	66766	.347
47918.0	943.41	5.38	2.81	26329	60677	69756	-2420	1384	-44	.688	1.846	65216	.336
46918.0	942.87	5.26	2.84	25836	60579	69183	-2454	1391	-107	.666	1.796	64881	.336
45918.0	942.45	5.13	2.87	25342	60514	68642	-2480	1396	-171	.646	1.740	64578	.336
44918.0	942.15	5.00	2.90	24848	60476	68129	-2499	1400	-234	.626	1.678	64302	.335
43918.0	941.98	4.86	2.93	24354	60460	67637	-2510	1402	-297	.607	1.609	64048	.334
42918.0	941.93	4.72	2.96	23859	60458	67159	-2513	1403	-361	.589	1.533	63808	.333
41918.0	942.02	4.56	3.00	23364	60460	66685	-2509	1401	-424	.572	1.451	63572	.332
40918.0	942.24	4.40	3.03	22868	60455	66202	-2497	1398	-487	.556	1.363	63328	.330
39918.0	942.61	4.24	3.07	22372	60427	65696	-2476	1393	-550	.541	1.267	63061	.327
38918.0	943.13	4.06	3.11	21875	60358	65150	-2446	1386	-612	.528	1.164	62754	.324
37918.0	943.84	3.87	3.15	21377	60229	64542	-2405	1376	-675	.517	1.055	62395	.320
36918.0	944.74	3.68	3.20	20879	60015	63849	-2354	1364	-738	.507	.938	61932	.315
35918.0	945.85	3.47	3.25	20381	59591	63045	-2289	1349	-800	.500	.814	61368	.309
34918.0	947.19	3.25	3.29	19881	59226	62101	-2210	1331	-862	.494	.684	60664	.302
33918.0	948.80	3.02	3.35	19381	58590	60984	-2116	1309	-924	.491	.546	59787	.294
32918.0	950.68	2.77	3.40	18880	57748	59660	-2005	1284	-986	.491	.402	58704	.284
31918.0	952.88	2.51	3.46	18378	56664	58093	-1875	1254	-1048	.493	.253	57378	.272
30918.0	955.42	2.23	3.52	17875	55300	56246	-1725	1220	-1109	.498	.097	55773	.259
29918.0	958.33	1.94	3.59	17371	53621	54082	-1553	1181	-1171	.506	-.063	53851	.244

3.2-117

SMA-8-D-027(III)REV 3

Amendment 114
9/15/71

X(A) COORDINATES

TABLE 3.2-23 (CONTINUED)

CSM-113 PLANE CHANGE 1

WEIGHT LBS.	X-BAR	Y-BAR INCHES	Z-BAR	IXX	IYY	IZZ SLUG-FT ²	PXY	PXZ	PYZ	PITCH DEGREES	YAW	AVERAGE MOMENT	INERTIA/THRUST RATIO
28678.0	961.94	1.70	3.60	16687	51385	51396	-1386	1165	-1175	.549	-.195	51391	.227
27678.0	965.76	1.36	3.67	16180	48881	48405	-1161	1116	-1236	.562	-.364	48643	.208
26678.0	970.09	.99	3.76	15672	45872	44908	-908	1060	-1296	.579	-.535	45390	.189
25678.0	975.09	.60	3.84	15162	42215	40761	-617	996	-1356	.599	-.709	41488	.166

3.2-120

SMA-8-D-027 (III) REV 3

X(A) COORDINATES

TABLE 3.2-24

CSM-113 T.E.I. BURN

WEIGHT LBS.	X-BAR	Y-BAR INCHES	Z-BAR	IXX	IYY	IZZ SLUG-FT SQ	PXY	PXZ	PYZ	PITCH DEGREES	YAW	AVERAGE MOMENT	INERTIA/THRUST RATIO
65776.1	933.69	5.05	4.85	35361	78182	79979	-2038	283	2589	-.612	1.929	79081	.447
64776.1	933.20	5.06	4.75	34840	77516	79743	-2026	241	2447	-.571	1.957	78630	.446
63776.1	932.82	5.10	4.66	34319	76931	79588	-2017	209	2304	-.526	1.983	78260	.446
62776.1	932.55	5.13	4.55	33798	76408	79496	-2010	185	2162	-.475	2.007	77952	.446
61776.1	932.38	5.16	4.45	33276	75928	79447	-2006	172	2020	-.419	2.028	77687	.445
60776.1	932.34	5.19	4.34	32754	75469	79414	-2005	168	1878	-.358	2.046	77444	.444
59776.1	932.41	5.22	4.23	32232	75010	79391	-2006	175	1736	-.292	2.061	77200	.442
58776.1	932.61	5.25	4.12	31709	74526	79339	-2011	193	1594	-.221	2.073	76932	.439
57776.1	932.94	5.28	4.00	31186	73993	79237	-2016	223	1452	-.145	2.081	76615	.436
56776.1	933.42	5.31	3.87	30663	73384	79060	-2029	266	1310	-.064	2.085	76222	.432
55776.1	934.04	5.35	3.75	30139	72669	78778	-2043	321	1169	.022	2.086	75724	.426
54776.1	934.82	5.38	3.61	29615	71818	78361	-2061	390	1027	.113	2.083	75090	.420
53776.1	935.76	5.42	3.48	29090	70799	77774	-2083	474	886	.208	2.075	74286	.411
52776.1	936.89	5.46	3.33	28565	69574	76983	-2109	573	745	.308	2.064	73278	.401
51776.1	938.20	5.50	3.19	28039	68105	75948	-2139	688	603	.412	2.048	72027	.390
50776.1	939.71	5.54	3.03	27513	66346	74624	-2174	822	462	.519	2.028	70485	.376
49776.1	941.41	5.58	2.87	26986	64272	72986	-2214	971	322	.629	2.003	68629	.360
48776.1	943.36	5.63	2.71	26459	61792	70941	-2259	1143	181	.743	1.975	66367	.342
47776.1	944.19	5.58	2.64	25948	60227	69381	-2316	1225	76	.786	1.930	64804	.332
46776.1	943.66	5.47	2.67	25456	60137	68818	-2349	1230	12	.767	1.883	64477	.331
45776.1	943.26	5.34	2.69	24963	60078	68284	-2373	1235	-50	.748	1.829	64181	.331
44776.1	942.98	5.21	2.72	24469	60045	67776	-2390	1238	-114	.731	1.769	63910	.331
43776.1	942.83	5.08	2.75	23975	60032	67287	-2399	1240	-178	.715	1.703	63659	.330
42776.1	942.80	4.94	2.78	23481	60031	66810	-2401	1240	-241	.700	1.630	63420	.329
41776.1	942.90	4.79	2.81	22987	60032	66335	-2396	1239	-305	.685	1.551	63183	.327
40776.1	943.15	4.64	2.84	22492	60022	65850	-2383	1236	-368	.672	1.465	62936	.325
39776.1	943.54	4.47	2.87	21996	59988	65338	-2362	1231	-431	.660	1.372	62663	.322
38776.1	944.09	4.30	2.90	21500	59911	64784	-2332	1224	-494	.650	1.272	62348	.319
37776.1	944.82	4.12	2.94	21004	59770	64165	-2291	1216	-557	.641	1.165	61968	.315
36776.1	945.75	3.93	2.98	20507	59542	63459	-2239	1205	-620	.633	1.051	61500	.310
35776.1	946.89	3.73	3.02	20009	59200	62637	-2176	1191	-683	.628	.930	60919	.304
34776.1	948.28	3.52	3.06	19511	58713	61672	-2098	1175	-746	.625	.802	60192	.297
33776.1	949.92	3.29	3.11	19011	58051	60529	-2005	1156	-809	.624	.667	59290	.288
32776.1	951.85	3.06	3.16	18511	57177	59174	-1896	1133	-871	.625	.525	58176	.278
31776.1	954.10	2.80	3.21	18011	56056	57571	-1768	1107	-933	.629	.378	56814	.267
30776.1	956.69	2.53	3.27	17509	54650	55682	-1621	1077	-995	.635	.225	55166	.254
29776.1	959.65	2.24	3.32	17006	52921	53470	-1452	1043	-1057	.644	.067	53195	.239

3.2-121

SMA-D-D-027 (III) REV 3

X(Y)COORDINATES

TABLE 3.2-25

LM-11 PRE P.D.I. TO TOUCHDOWN

HEIGHT LBS.	X-BAR	Y-BAR INCHES	Z-BAR	IXX	IYY	IZZ SLUG-FT SQ	PXY	PXZ	PYZ	PILOT ROLL DEGREES	PILOT PITCH DEGREES
36599.4	184.93	.46	-.41	27198	28455	26941	66	799	170	.858	.767
36074.6	185.19	.47	-.42	26868	28244	26804	66	799	171	.859	.767
35549.8	185.42	.47	-.42	26537	28029	26664	65	800	171	.862	.768
35025.0	185.64	.46	-.43	26206	27812	26521	65	800	172	.865	.770
34500.2	185.85	.48	-.43	25876	27593	26377	65	800	173	.868	.772
33975.4	186.05	.49	-.43	25545	27373	26231	65	800	174	.872	.775
33450.6	186.26	.49	-.44	25215	27153	26085	64	800	175	.876	.777
32925.7	186.47	.50	-.44	24884	26931	25938	64	800	175	.881	.780
32400.9	186.69	.51	-.45	24553	26709	25790	64	800	176	.885	.783
31876.1	186.93	.51	-.45	24223	26484	25640	63	801	177	.889	.785
31351.3	187.19	.52	-.46	23892	26257	25488	63	801	178	.893	.788
30826.5	187.47	.52	-.46	23562	26027	25332	63	801	178	.896	.790
30301.7	187.76	.53	-.47	23231	25792	25172	62	801	179	.900	.791
29776.9	188.12	.54	-.47	22900	25551	25005	62	801	180	.902	.793
29252.1	188.49	.54	-.48	22570	25303	24832	61	802	181	.905	.793
28727.3	188.89	.55	-.48	22239	25046	24649	60	802	181	.906	.794
28202.5	189.34	.56	-.49	21909	24779	24456	60	803	182	.907	.793
27677.6	189.83	.57	-.50	21578	24499	24251	59	804	183	.908	.793
27152.8	190.36	.58	-.50	21247	24206	24032	57	804	184	.907	.791
26628.0	190.94	.58	-.51	20917	23895	23796	56	805	185	.907	.789
26103.2	191.57	.59	-.52	20586	23575	23550	55	806	185	.905	.787
25578.4	192.24	.60	-.52	20256	23240	23290	53	807	186	.903	.784
25053.6	192.97	.61	-.53	19925	22889	23013	52	808	187	.900	.780
24528.8	193.76	.62	-.54	19594	22522	22721	50	810	188	.897	.776
24004.0	194.60	.63	-.55	19264	22139	22413	48	811	188	.894	.772
23479.2	195.50	.64	-.56	18933	21739	22087	46	812	189	.890	.767
22954.4	196.46	.66	-.56	18603	21322	21745	44	814	190	.885	.762
22429.6	197.48	.67	-.57	18272	20888	21385	41	816	191	.880	.757
21904.7	198.56	.68	-.58	17941	20437	21008	39	818	192	.875	.751
21379.9	199.72	.69	-.59	17611	19967	20613	36	820	192	.870	.745
20855.1	200.94	.71	-.61	17280	19480	20200	33	822	193	.864	.739
20330.3	202.23	.72	-.62	16949	18973	19768	30	825	194	.858	.733
19805.5	203.61	.74	-.63	16619	18445	19314	26	828	195	.852	.726
19280.7	205.06	.75	-.64	16288	17899	18843	22	830	196	.847	.720
18755.9	206.60	.77	-.66	15957	17335	18353	19	833	196	.841	.714
18231.1	208.22	.79	-.67	15627	16750	17843	14	837	197	.835	.707
17707.1	209.93	.81	-.68	15296	16145	17312	10	840	198	.829	.701

3.2-123

DL-8-D-027(III)REV 3

X(E) COORDINATES

TABLE 3.2-25 (CONTINUED)

LM-11 PRE P.O.I. TO TOUCHDOWN

WEIGHT LBS.	X-BAR	Y-BAR INCHES	Z-BAR	1XX	1YY	1ZZ SLUG-FT SQ	PXY	PXZ	PYZ	PILOT ROLL DEGREES	PILOT PITCH DEGREES
17333.5	211.04	.82	-.69	15092	15681	17049	7	842	199	.825	.696
17383.5	211.03	.82	-.69	15089	15677	17044	8	841	199	.822	.693
17377.5	211.01	.82	-.69	15086	15672	17038	9	840	200	.820	.690
17374.5	211.00	.81	-.68	15084	15668	17033	10	840	201	.817	.687
17374.5	211.00	.81	-.68	15083	15667	17032	10	839	202	.814	.684
17374.5	211.00	.81	-.68	15081	15666	17031	11	838	202	.811	.681
17374.5	211.00	.80	-.68	15080	15665	17030	12	837	203	.808	.678
17374.5	211.01	.80	-.67	15079	15664	17029	13	837	203	.805	.675
17374.5	211.01	.80	-.67	15078	15663	17028	13	836	204	.802	.672
17374.5	211.01	.80	-.67	15076	15662	17027	14	835	205	.799	.670
17374.5	211.01	.79	-.66	15075	15661	17026	15	834	205	.796	.667
17374.5	211.01	.79	-.66	15074	15660	17025	15	834	206	.793	.664
17374.5	211.01	.79	-.66	15073	15660	17024	16	833	206	.790	.661
17374.5	211.01	.78	-.65	15072	15659	17023	17	832	207	.787	.658
17374.5	211.01	.78	-.65	15070	15658	17022	18	832	208	.784	.655
17374.5	211.01	.78	-.65	15069	15657	17021	18	831	208	.782	.652
17374.5	211.01	.77	-.65	15068	15656	17020	19	830	209	.779	.649
17374.5	211.01	.77	-.64	15067	15655	17019	20	829	209	.776	.646
17374.5	211.01	.77	-.64	15066	15654	17018	20	829	210	.773	.643
17374.5	211.01	.77	-.64	15064	15653	17017	21	828	211	.770	.640
17374.5	211.02	.76	-.63	15063	15652	17017	22	827	211	.767	.637
17374.5	211.02	.76	-.63	15062	15651	17016	23	827	212	.764	.634
17374.5	211.02	.76	-.63	15061	15650	17015	23	826	212	.761	.631
17374.5	211.02	.75	-.62	15060	15649	17014	24	825	213	.758	.628
17374.5	211.02	.75	-.62	15058	15648	17013	25	824	214	.755	.625
17374.5	211.02	.75	-.62	15057	15647	17012	25	824	214	.752	.622
17374.5	211.02	.75	-.62	15056	15646	17011	26	823	215	.749	.619
17374.5	211.02	.74	-.61	15055	15645	17010	27	822	215	.746	.616
17374.5	211.02	.74	-.61	15053	15644	17009	28	822	216	.743	.613
17374.5	211.02	.74	-.61	15052	15643	17008	28	821	217	.740	.610
17374.5	211.02	.73	-.60	15051	15643	17007	29	820	217	.737	.607
17374.5	211.02	.73	-.60	15050	15642	17006	30	819	218	.734	.604
17374.5	211.02	.73	-.60	15049	15641	17005	30	819	219	.731	.601
17374.5	211.03	.72	-.59	15047	15640	17004	31	818	219	.728	.598
17374.5	211.03	.72	-.59	15046	15639	17003	32	817	220	.725	.595
17374.5	211.03	.72	-.59	15045	15638	17002	33	816	220	.722	.592
17374.5	211.03	.72	-.59	15044	15637	17002	33	816	221	.719	.589

3.2-124

SMA-8-D-027 (III) REV 3

Amendment 114
9/15/71

(E) COORDINATES

TABLE 3.2-26 LM-11 AS LUNAR LIFTOFF TO INSERTION

WEIGHT LBS.	X-BAR	Y-BAR INCHES	Z-BAR	IXX	IYY	IZZ SLUG-FT SQ.	PXY	PXZ	PYZ	ROLL MOMENT OFFSET (DEG./SEC. SQ.)	PITCH MOMENT
13863.3	243.78	.08	2.78	6746	3393	5963	67	176	-25	.210	6.108
10602.7	244.16	.08	2.85	6567	3378	5771	67	173	-25	.219	5.850
10342.2	244.57	.08	2.92	6388	3363	5577	67	171	-25	.227	5.577
10081.6	245.00	.08	3.00	6210	3347	5383	67	168	-25	.237	5.287
9821.0	245.45	.08	3.07	6031	3329	5188	67	165	-25	.248	4.978
9560.5	245.93	.08	3.16	5852	3311	4992	67	162	-25	.259	4.649
9299.9	246.43	.08	3.25	5673	3292	4795	67	159	-25	.271	4.298
9039.3	246.96	.08	3.34	5494	3272	4597	67	155	-25	.285	3.922
8778.8	247.52	.08	3.44	5315	3250	4398	67	151	-25	.300	3.519
8518.2	248.12	.08	3.54	5136	3228	4197	67	147	-25	.317	3.085
8257.6	248.75	.08	3.66	4957	3203	3996	67	143	-25	.336	2.616
7997.0	249.43	.08	3.78	4778	3178	3792	67	139	-25	.357	2.110
7736.5	250.15	.08	3.90	4599	3150	3587	67	134	-25	.381	1.560
7475.9	250.92	.08	4.04	4419	3121	3380	67	129	-25	.409	.961
7215.3	251.75	.08	4.18	4240	3089	3171	67	124	-25	.440	.307
6954.8	252.64	.09	4.34	4061	3055	2960	67	118	-25	.477	-.412
6694.2	253.60	.09	4.51	3881	3018	2746	67	112	-25	.520	-1.205
6433.6	254.64	.09	4.69	3702	2979	2529	67	105	-25	.572	-2.084
6173.1	255.76	.09	4.89	3522	2936	2309	67	98	-25	.635	-3.064
5912.5	256.99	.09	5.11	3342	2889	2086	67	90	-25	.714	-4.164

3.2-125

SEA-D-D-027(III)REV 3

Y Y

Y Y Y Y Y Y

Y Y Y Y Y Y Y Y

Y Y Y Y Y Y Y Y Y Y

Y Y Y Y Y Y Y Y Y Y Y Y

Y Y Y Y Y Y Y Y Y Y Y Y Y Y Y Y

SUPPLEMENTARY DATA APPLICABLE TO SEQUENTIAL MASS PROPERTIES TABLES

General Comments to be Applied to Tables 3.3-1 through 3.3-8:

Inertia data dispersions are +10%.

Dispersions shall be used as 3σ deviation values.

All initial propellant weights are total tanked.

LM propellants are assumed to be in the low ends of their tanks except when in the CSM/LM docked configuration. In the CSM/LM docked configuration, LM propellants are assumed to be in the high ends of their tanks. CSM propellants are always assumed to be in the low ends of their tanks.

The (+) or (-) sign following the name of an item indicates that the item is added to or subtracted from the preceding total.

Table 3.3-1

SM/SPS gimbal angles for SPS abort sequence are: Pitch = -1.530 deg.
Yaw = 1.315 deg.

Tables 3.3-7 and 3.3-8

CSM and LM consumables changes are presented in Tables 3.3-7 and 3.3-8, respectively.

Tables 3.3-4 and 3.3-5

Delta Z	=	0.75 in.
LES motor tilted angles	Delta =	2.124 deg.
	Sigma =	270.121 deg.
LES motor tilted confluence point	X =	1222.379 in.
	Y =	0.001 in.
	Z =	0.224 in.
PCM motor tilted angles	Delta =	89.324 deg.
	Sigma =	270.676 deg.
PCM motor tilted confluence point	X =	1428.970 in.
	Y =	0.018 in.
	Z =	2.662 in.

The docking probe and ring are jettisoned at $t=14.0$ seconds in Table 3.3-4 and Table 3.3-5. Reference Memorandum EX24/8912-344B, dated December 4, 1969.

Table 3.3-5 includes a rapid depletion of CM/RCS oxidizer from $t=0.0$ to $t=9.0$ seconds and of CM/RCS fuel from $t=5.0$ to $t=14.0$ seconds.



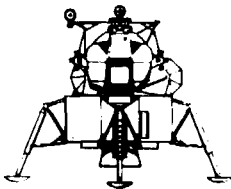

XE COORDINATES TABLE 3.3-1
LM-7 EXPECTED EARTH LAUNCH MASS PROPERTIES

Amendment 79
3/30/70

DESCRIPTION	S	WEIGHT POUNDS	C. G. INCHES			INERTIAS SLUG-FT ²			PRODUCTS SLUG-FT ²		
			X	Y	Z	IXX	IYY	IZZ	PXY	PKZ	PYZ
ASCENT STAGE	+	4659.0	257.7	.2	2.1	2761	2673	1532	54	129	7
LM RCS FUEL	+	102.3	279.1	44.6	14.5	0	0	0	0	0	0
LM RCS FUEL	+	102.3	279.1	-44.6	-14.5	0	0	0	0	0	0
LM RCS OXY	+	200.0	275.4	-44.6	14.5	0	1	1	0	0	0
LM RCS OXY	+	200.0	275.4	44.6	-14.5	0	1	1	0	0	0
LM APS FUEL	+	2008.6	227.5	-71.3	.0	5	5	5	0	0	0
LM APS OXY	+	3220.4	227.6	44.5	.0	8	8	8	0	0	0
ASCENT STAGE		10492.6	243.8	.1	.9	6645	3352	6021	59	158	-20
DESCENT STAGE	+	4661.0	153.3	-0.9	-3.7	4200	2769	2856	57	22	394
LM DPS FUEL	+	3524.2	160.0	54.0	.0	10	55	55	0	0	0
LM DPS FUEL	+	3524.3	160.0	-54.0	.0	10	55	55	0	0	0
LM DPS OXY	+	5645.2	160.0	.0	54.0	17	89	89	0	0	0
LM DPS OXY	+	5645.2	160.0	.0	-54.0	17	89	89	0	0	0
DESCENT STAGE		22999.9	158.6	-.2	-.8	15810	10211	7618	61	42	396
LM AT EARTH LAUNCH		33492.5	185.3	-.1	-.2	22460	24844	24915	160	426	377

DISPERSIONS LB/IN			
DW	DX	DY	DZ
25.0	1.0	.1	.1
1.0	1.0	.1	.1
1.0	1.0	.1	.1
2.0	1.0	.1	.1
2.0	1.0	.1	.1
5.4	1.0	.5	.5
8.7	1.0	.5	.5
27.2	.6	.2	.2
25.0	1.0	.1	.1
7.1	1.0	.5	.5
7.1	1.0	.5	.5
12.7	1.0	.5	.5
12.7	1.0	.5	.5
32.4	.5	.2	.2
42.3	.4	.2	.2

SNA-8-D-027(III)REV 2

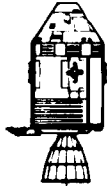

XA COORDINATES
 TABLE 3.3-1 (CONTINUED)
 CSM-109 EXPECTED EARTH LAUNCH MASS PROPERTIES

Amendment 79
 3/30/70

DESCRIPTION	S	WEIGHT POUNDS	C. G. INCHES			INERTIAS SLUG-FT ²			PRODUCTS SLUG-FT ²		
			X	Y	Z	IXX	IYY	IZZ	PXY	PXZ	PYZ
SLA RING	+	98.0	835.7	2.0	-6.6	120	65	56	0	0	0
SM	+	10531.7	918.8	-5.9	10.9	7135	11625	11110	-130	460	-580
CM	+	12595.0	1041.1	.1	6.0	5895	5395	4853	50	-440	-35
CSM LESS SPS PROPELLANT		23224.7	984.8	-2.6	8.2	13229	36108	35052	813	-675	-652
SM SPS F-SUMP	+	8868.7	906.8	-48.3	-6.6	0	2608	2608	0	0	0
SM SPS O-SUMP	+	14199.4	907.0	48.3	6.6	0	4210	4210	0	0	0
SM SPS F-STORE	+	6737.9	903.8	-14.8	-47.8	0	1898	1898	0	0	0
SM SPS O-STORE	+	10760.6	903.9	14.8	47.8	0	3039	3039	0	0	0
SM WITH SPS PROPELLANT		51196.3	908.2	5.0	6.7	28128	32519	35617	-368	554	3165
CSM AT EARTH LAUNCH		63791.3	934.4	4.0	6.5	34076	76460	79068	-1734	-80	3137

DISPERSIONS LB/IN			
OW	DX	DY	DZ
.0	.0	.0	.0
50.0	.2	.1	.1
50.0	.2	.1	.1
70.7	.2	.1	.1
59.0	1.0	.5	.5
121.0	1.0	.5	.5
59.0	1.0	.5	.5
121.0	1.0	.5	.5
196.8	.4	.2	.2
203.1	.4	.2	.2

N
 U
 C
 I
 D
 E
 N
 T
 I
 A
 L
 I
 D
 E
 N
 T
 I
 T
 Y
 R
 E
 C
 O
 R
 D
 S

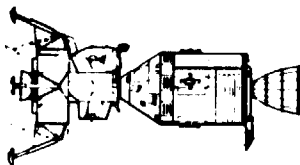

XA COORDINATES TABLE 3.3-2
 CSM 109/LM-7 EXPECTED SEQUENTIAL MASS PROPERTIES

Amendment 79
 3/30/70

DESCRIPTION	S	WEIGHT POUNDS	C. G. INCHES			INERTIAS SLUG-FT ²			PRODUCTS SLUG-FT ²		
			X	Y	Z	IXX	IYY	IZZ	PXY	PNZ	PYZ
CSM AT EARTH LAUNCH		63791.3	934.4	4.0	6.5	34076	76460	79068	-1734	-80	3137
LM AT EARTH LAUNCH		33492.5	584.8	-0.1	-0.2	22460	24844	24915	160	426	377
SLA(EXCLUDING RING)		3946.7	640.0	1.4	.6	10118	12781	12693	-141	46	-17
LES		9011.8	1298.1	.0	.5	827	27826	27797	8	708	0
CSM+LM+SLA+LES AT LAUNCH		110242.3	847.4	2.3	3.8	67824	1176659	1179063	3034	9691	3649
CSM+LM+SLA AT E.O.I.		101230.5	807.3	2.6	4.1	66963	718521	720966	5267	12114	3633
CSM+LM+SLA PRE TRANS/DOCK		101221.2	807.3	2.6	4.1	66961	718528	720978	5263	12100	3637
CSM AT TRANS/DOCK .		63711.4	934.4	4.0	6.5	33999	76415	79035	-1741	-78	3158
LM AT TRANS/DOCK .		33489.8	1237.3	-0.2	.0	22455	24699	25322	-446	79	218
CSM/LM DOCKED		97201.2	1038.8	2.6	4.3	56742	535835	538964	-8308	-9346	3509

DISPERSIONS LB/IN			
DW	DX	DY	DZ
203.1	.4	.2	.2
42.3	.4	.2	.2
5.0	.2	.1	.1
25.0	.0	.0	.0
209.0	.3	.1	.1
207.5	.3	.1	.1
207.5	.3	.1	.1
203.1	.4	.2	.2
42.3	.4	.2	.1
207.4	.4	.1	.1

SNA-8-D-027(III)REV 2

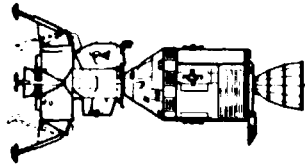

XA COORDINATES
 TABLE 3.3-2 (CONTINUED)
 CSM 109/LM-7 EXPECTED SEQUENTIAL MASS PROPERTIES

Amendment 79
 3/30/70

DESCRIPTION	S	WEIGHT POUNDS	C. G. INCHES			INERTIAS SLUG-FT ²			PRODUCTS SLUG-FT ²		
			X	Y	Z	IXX	IYY	IZZ	PXY	PXZ	PYZ
CM EQUIP. RELOC. 1	-	179.2	1040.8	3.8	-12.1	21	12	22	2	4	3
CM EQUIP. RELOC1	+	179.2	1023.1	1.6	-14.1	24	14	21	0	4	-3
PRE SPS HYBRID XFR BURN		97098.6	1038.9	2.6	4.3	56664	535409	538525	-8359	-9288	3528
POST SPS HYBRID XFR BURN		96938.8	1039.0	2.6	4.3	56580	535165	538350	-8357	-9272	3504
CSM/LM PRE M.C.C.		96881.9	1039.1	2.6	4.3	56545	534968	538161	-8392	-9230	3518
CSM/LM POST M.C.C.		96537.0	1039.3	2.6	4.2	56365	534417	537758	-8387	-9193	3467
CSM/LM PRE L.O.I.		96454.0	1039.4	2.6	4.2	56306	534147	537499	-8426	-9149	3489
CSM/LM POST L.O.I.		72943.5	1079.0	1.6	2.9	44118	417285	424851	-6396	-5235	599
CSM/LM PRE D.O.I. BURN		72882.6	1079.2	1.6	2.9	44059	416973	424548	-6407	-5228	614
CSM/LM POST D.O.I. BURN		71345.3	1082.4	1.4	2.9	43281	409585	416411	-5932	-5297	518

DISPERSIONS LB/IN			
DX	OX	DY	OZ
.0	.0	.0	.0
.0	.0	.0	.0
207.4	.4	.1	.1
207.4	.4	.1	.1
207.4	.4	.1	.1
232.8	.4	.1	.1
232.8	.4	.1	.1
157.8	.4	.2	.1
157.8	.4	.2	.1
157.8	.5	.2	.1

SNA-8-D-027(III)REV 2

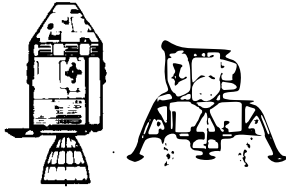

XA COORDINATES
CSM 109/LM-7 EXPECTED SEQUENTIAL MASS PROPERTIES

TABLE 3.3-2 (CONTINUED)

Amendment 79
3/30/70

DESCRIPTION	S	WEIGHT POUNDS	C. G. INCHES			INERTIAS SLUG-FT ²			PRODUCTS SLUG-FT ²		
			X	Y	Z	IXX	IYY	IZZ	PXY	PXZ	PYZ
2 CREW + EQUIPMENT	-	469.7	1038.1	11.1	-12.2	26	21	33	3	7	0
CM/LM UMBILICAL	+	1.1	1025.0	24.5	-10.0	0	0	0	0	0	0
CM EQUIP. RELOC. 2	-	58.0	1027.5	-3.7	-11.4	7	4	7	0	1	-1
CM EQUIP. RELOC. 2	+	58.0	1034.5	-12.8	-13.6	3	2	5	-1	0	0
LANDING GEAR UP	-	488.0	1306.5	1.1	-.7	740	444	451	-2	1	-6
LANDING GEAR DOWN	+	488.0	1303.1	1.6	-.9	1921	1027	1039	-3	2	-10
CM GASEOUS O ₂	+	6.7	1168.7	13.0	-7.5	0	0	0	0	0	0
2 CREW + EQUIPMENT	+	469.7	1172.0	37.3	-21.3	52	38	16	1	1	21
CM/LM UMBILICAL	-	1.1	1122.7	.0	-.0	0	0	0	0	0	0
LM EQUIP. RELOC. 1	-	25.9	1179.7	44.7	-25.6	1	5	4	0	0	0
LM EQUIP. RELOC. 1	+	25.9	1161.2	7.9	-8.7	1	0	0	0	0	0
EQUIP. XFER, CM-LM	-	17.0	1021.4	24.3	-19.9	0	0	1	0	0	0
EQUIP. XFER, CM-LM	+	17.0	1166.0	29.5	-16.3	1	0	0	0	0	0
CSM/LM AT SEPARATION		71220.8	1083.4	1.6	2.8	44519	409924	416806	-5563	-5550	492

DISPERSIONS LB/IN			
DW	DX	DY	DZ
.0	.0	.0	.0
.0	.0	.0	.0
.0	.0	.0	.0
.0	.0	.0	.0
.0	.0	.0	.0
.0	.0	.0	.0
.0	.0	.0	.0
.0	.0	.0	.0
.0	.0	.0	.0
.0	.0	.0	.0
.0	.0	.0	.0
.0	.0	.0	.0
.0	.0	.0	.0
.0	.0	.0	.0
.0	.0	.0	.0
157.8	.5	.2	.1

SN-A-8-D-027(III)REV 2

U
N
I
T
E
D
S
T
A
T
E
S
O
F
A
M
E
R
I
C
A

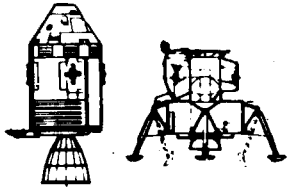

XA COORDINATES
CSM 109/LM-7 EXPECTED SEQUENTIAL MASS PROPERTIES

TABLE 3.3-2 (CONTINUED)

Amendment 79
3/30/70

DESCRIPTION	S	WEIGHT POUNDS	C. G. INCHES			INERTIAS SLUG-FT ²			PRODUCTS SLUG-FT ²		
			X	Y	Z	I _{XX}	I _{YY}	I _{ZZ}	P _{XY}	P _{XZ}	P _{YZ}
CSM PRE CIRC. BURN		37201.8	944.2	2.8	5.7	20447	56748	63060	-2069	899	292
CSM POST CIRC. BURN		36928.8	944.3	2.8	5.7	20309	56734	62915	-2060	895	277
CSM PRE PLANE CHANGE I		36828.4	944.3	2.8	5.7	20220	56668	62863	-2062	900	294
CSM PCST PLANE CHANGE I		36149.3	944.7	2.6	5.8	19877	56619	62488	-2037	887	255
CSM AT ASCT.STAGE DOCKING		35937.3	944.8	2.6	5.8	19682	56474	62370	-2034	899	292
ASCENT STAGE AT DOCKING		5685.7	1167.6	4.2	-1.9	3292	2299	2758	-129	11	-392
CSM/ASCENT STAGE MANNED		41623.0	975.2	2.8	4.7	23040	111444	117739	-1798	-901	-112

DISPERSIONS LB/IN			
OW	OX	OY	OZ
152.1	.4	.2	.2
152.1	.4	.2	.2
152.1	.4	.2	.2
152.1	.4	.2	.1
152.1	.4	.2	.2
27.0	.8	.1	.1
154.4	.4	.2	.1

SNA-8-D-027(III)REV 2

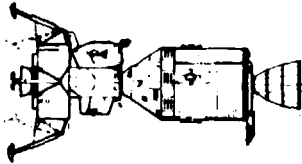

XA COORDINATES
 TABLE 3.3-2 (CONTINUED)
 CSM 109/LM-7 EXPECTED SEQUENTIAL MASS PROPERTIES

Amendment 79
 3/30/70

DESCRIPTION	S	WEIGHT POUNDS	C. G. INCHES			INERTIAS SLUG-FT ²			PRODUCTS SLUG-FT ²		
			X	Y	Z	IXX	IYY	IZZ	PXY	PXZ	PYZ
LM EQUIP.RELOC.4	-	20.0	1122.7	.0	-0.0	0	0	0	0	0	0
LM EQUIP.RELOC.4	+	20.0	1204.2	31.4	-40.8	0	0	0	0	0	0
ONLOAD AT LUN.SITE	-	203.0	1154.6	-12.9	-8.1	4	5	4	-1	-2	1
EQUIP. XFER, AS-CM	-	17.9	1162.7	21.0	-5.3	4	2	2	0	0	0
EQUIP. XFER, CM-AS	+	281.4	1150.9	3.6	-16.2	33	99	102	19	-34	-10
CM/LM UMBILICAL	+	1.1	1122.7	.0	-0.0	0	0	0	0	0	0
ONLOAD AT LUN.SITE	+	203.0	1024.2	2.3	22.0	33	31	15	-1	9	6
EQUIP. XFER, AS-CM	+	17.8	1021.8	12.2	-22.7	3	0	3	0	0	0
EQUIP. XFER, CM-AS	-	281.4	1085.3	1.1	11.3	23	104	86	-4	-36	0
CM/LM UMBILICAL	-	1.1	1025.0	24.5	-10.0	0	0	0	0	0	0
CSM/ASCENT STAGE UNMANNED		41610.6	973.5	2.6	4.8	22934	107679	113894	-2251	-638	-80

DISPERSIONS LB/IN			
DW	DX	DY	DZ
.0	.0	.0	.0
.0	.0	.0	.0
.0	.0	.0	.0
.0	.0	.0	.0
.0	.0	.0	.0
.0	.0	.0	.0
.0	.0	.0	.0
.0	.0	.0	.0
.0	.0	.0	.0
154.4	.4	.2	.1

SNA-8-D-027(III)REV 2

U
S
S
R
S
P
A
C
E
S
H
I
P
S
A
N
D
S
T
A
T
I
O
N
S

U
S
N
A
V
Y
A
I
R
F
O
R
C
E

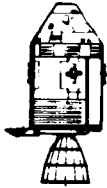

XA COORDINATES
CSM 109/LM-7 EXPECTED SEQUENTIAL MASS PROPERTIES

TABLE 3.3-2 (CONTINUED)

Amendment 79
3/30/70

DESCRIPTION	S	WEIGHT POUNDS	C. G. INCHES			INERTIAS SLUG-FT ²			PRODUCTS SLUG-FT ²		
			X	Y	Z	I _{XX}	I _{YY}	I _{ZZ}	P _{XY}	P _{XZ}	P _{YZ}
CSM PCST A/S JETTISON		36345.3	945.4	2.8	5.6	19780	56446	62321	-1934	780	282
CSM PRE PLANE CHANGE 2		36283.4	945.4	2.8	5.5	19727	56407	62291	-1936	786	291
CSM POST PLANE CHANGE 2		33417.4	949.1	2.0	5.9	18277	55794	60301	-1761	700	127
CM EQUIP. RELOC. 3	-	58.5	1033.3	-11.9	-13.9	4	2	6	-2	0	0
CM EQUIP. RELOC. 3	+	58.5	1027.9	14.1	-8.9	7	4	7	-1	0	-1
CSM PRE T.E.I.		33334.6	948.2	2.1	5.9	18206	55723	60240	-1730	713	132
CSM POST T.E.I.		24370.8	973.9	-1.2	7.5	13586	42372	42529	-56	-93	-346
CM EQUIP. RELOC. 4	-	42.1	1031.6	10.9	-2.9	14	6	10	0	0	-3
CM EQUIP. RELOC. 4	+	42.1	1042.8	5.4	-10.1	10	9	10	2	3	1
CSM PRE CM/SM SEPARATION		24030.8	974.5	-1.2	7.4	13306	42039	42230	-51	-47	-307
SM POST CM/SM SEPARATION		11453.5	903.2	-2.8	8.5	7334	12744	13523	-619	757	-262

DISPERSIONS LB/IN			
DW	DX	DY	DZ
152.1	.4	.2	.1
152.1	.4	.2	.1
152.1	.4	.2	.1
.0	.0	.0	.0
.0	.0	.0	.0
152.1	.4	.2	.1
152.1	.7	.3	.1
.0	.0	.0	.0
.0	.0	.0	.0
152.1	.7	.3	.1
143.6	.7	.6	.1

U
N
I
T
E
D
S
T
A
T
E
S
O
F
A
M
E
R
I
C
A

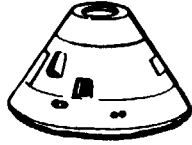

XA COORDINATES TABLE 3.3-2 (CONTINUED)
CSM 1G9/M-7 EXPECTED SEQUENTIAL MASS PROPERTIES

Amendment 79
3/30/70

DESCRIPTION	S	WEIGHT POUNDS	C. G. INCHES			INERTIAS SLUG-FT ²			PRODUCTS SLUG-FT ²		
			X	Y	Z	IXX	IYY	IZZ	PXY	PXZ	PYZ
CM PCST CM/SM SEPARATION		12577.3	1039.5	.2	6.3	5955	5277	4684	55	-422	-36
CM AT ENTRY		12565.3	1039.5	.1	6.3	5948	5269	4683	55	-420	-37
ABLATOR BURNOFF	-	150.0	1031.1	.0	7.4	103	81	78	0	0	0
ENTRY COOLING H ₂ O	-	2.0	1022.6	-19.7	62.5	0	0	0	0	0	0
FWD ₂ HEAT SHIELD	-	310.0	1094.3	-.5	.8	64	26	23	0	0	0
DROGUE+DISCONNECTS	-	80.3	1089.0	.0	-23.9	1	1	0	0	0	0
CM AT MAIN CHUTE DEPLOY		11990.8	1037.9	.1	6.5	5743	4870	4327	58	-367	-40
PILOT CHUTE+RISERS	-	45.5	1089.9	5.9	-5.8	2	2	1	0	0	0
MAIN CHUTE	-	401.4	1089.1	.4	8.5	62	22	43	0	0	0
CM RCS DUMP	-	201.4	1022.6	-7.3	57.0	0	0	0	0	0	0
CM AT IMPACT		11342.5	1036.1	.2	5.5	5561	4459	4009	58	-340	-55

DISPERSIONS LB/IN			
DW	DX	DY	DZ
50.0	.2	.1	.1
50.0	.2	.1	.1
.0	.0	.0	.0
.0	.0	.0	.0
.0	.0	.0	.0
.0	.0	.0	.0
50.0	.2	.1	.1
.0	.0	.0	.0
.0	.0	.0	.0
.0	.0	.0	.0
50.0	.2	.1	.1

SNA-8-D-027 (III) REV 2

U
S
S
P
A
C
E
S
H
I
P
S
C
R
I
P
T
I
O
N

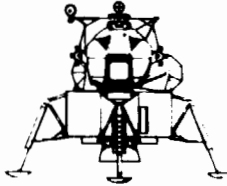

XE COORDINATES
 TABLE 3.3-3
 LM-7 EXPECTED SEQUENTIAL MASS PROPERTIES

Amendment 79
 3/30/70

DESCRIPTION	S	WEIGHT POUNDS	C. G. INCHES			INERTIAS SLUG-FT ²			PRODUCTS SLUG-FT ²		
			X	Y	Z	IXX	IYY	IZZ	PXY	PXZ	PYZ
LM AT EARTH LSO LCH		33492.5	195.3	-0.1	-0.2	22460	24944	24915	160	426	377
LANDING GEAR DOWN	+	486.0	119.7	.0	1.8	1921	1046	1021	0	4	0
LANDING GEAR UP	-	486.0	116.3	.0	1.3	740	455	441	0	3	0
LM CABLING	-	2.7	239.7	98.6	-29.0	0	0	0	0	0	0
CM GASEOUS O ₂	+	6.7	254.0	.0	15.0	0	0	0	0	0	0
C4/LM UMBILICAL	-	1.1	300.7	.0	.0	0	0	0	0	0	0
2 CREW + EQUIPMENT	+	469.7	250.8	.2	43.0	52	3	52	-2	-1	1
LM EQUIP. RELOC. 1	-	25.9	243.0	.2	51.5	1	4	6	0	0	0
LM EQUIP. RELOC. 1	+	25.9	241.5	-3.6	11.2	1	1	0	0	0	0
EQUIP. XFER, CM-LM	+	17.0	256.8	.0	33.7	1	0	1	0	0	0
LM AT SEPARATION		33959.5	196.3	-0.1	.4	23850	26007	25932	155	702	376
LM EQUIP. RELOC. 2	-	90.8	262.9	-19.6	-7.2	1	0	1	0	0	0
LM EQUIP. RELOC. 2	+	90.8	220.3	-0.2	44.4	0	0	0	0	0	0
LM PRE P.O.I.		33981.0	186.0	-0.0	.6	23834	25916	25676	179	740	366

DISPERSIONS LB/IN			
DX	DY	DZ	D2
42.3	.4	.2	.2
.0	.0	.0	.0
.0	.0	.0	.0
.0	.0	.0	.0
.0	.0	.0	.0
.0	.0	.0	.0
.0	.0	.0	.0
.0	.0	.0	.0
.0	.0	.0	.0
.0	.0	.0	.0
.0	.0	.0	.0
.0	.0	.0	.0
.0	.0	.0	.0
42.3	.4	.2	.2
.0	.0	.0	.0
.0	.0	.0	.0
42.3	.4	.2	.2

SNA-B-D-027(III)REV 2

U
N
I
T
E
D
S
T
A
T
E
S
O
F
A
M
E
R
I
C
A

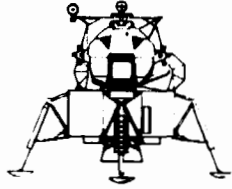

XE COORDINATES
LM-7 EXPECTED SEQUENTIAL MASS PROPERTIES

TABLE 2.3-3 (CONTINUED)

Amendment 79
3/30/70

DESCRIPTION	S	WEIGHT POUNDS	C. G. INCHES			INERTIAS SLUG-FT ²			PRODUCTS SLUG-FT ²		
			X	Y	Z	IXX	IYY	IZZ	PXY	PXZ	PYZ
DESCENT ABLATION	-	29.0	145.4	.0	.0	1	2	2	0	0	0
HELIUM TRANSFER	-	48.5	148.5	47.2	-47.0	0	0	0	0	0	0
HELIUM TRANSFER	+	48.5	158.6	3.1	-8.7	0	0	0	0	0	0
LM AT TOUCHDOWN		15659.7	210.0	-0.1	1.3	12948	14712	17016	205	614	393
ASCENT STAGE AT TOUCHDOWN		10826.9	243.2	.2	3.2	6805	3485	5936	66	177	-13
LEFT AT LUNAR SITE	-	252.7	245.4	-8.3	27.3	36	46	42	-9	-18	6
UNLOAD AT LUNAR SITE	+	253.0	253.2	-13.5	-7.1	4	4	8	3	0	0
LM EQUIP. RELOC. 3	-	7.8	255.5	-12.2	23.3	0	0	0	0	0	0
LM EQUIP. RELOC. 3	+	7.8	252.5	17.1	29.7	1	1	1	0	0	0
ASCENT STAGE AT LIFTOFF		10747.1	243.6	.2	2.4	6749	3442	5934	64	182	0
ASCT STG ABLATION	-	10.0	220.2	.0	.0	0	0	0	0	0	0
ASCENT STAGE IN ORBIT		5954.7	255.0	.4	4.4	3365	3022	2167	54	112	-2

DISPERSIONS LB/IN			
CW	DX	DY	DZ
.0	.0	.0	.0
.0	.0	.0	.0
.0	.0	.0	.0
42.3	.5	.1	.1
27.2	.6	.2	.2
.0	.0	.0	.0
.0	.0	.0	.0
.0	.0	.0	.0
.0	.0	.0	.0
27.2	.6	.2	.2
.0	.0	.0	.0
27.2	.8	.1	.1

SNA-B-D-027(III)REV 2

U
N
I
T
E
D
S
T
A
T
E
S
O
F
A
M
E
R
I
C
A

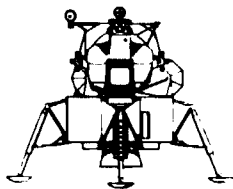

XE COORDINATES
LM-7 EXPECTED SEQUENTIAL MASS PROPERTIES

TABLE 3.3-3 (CONTINUED)

Amendment 79
3/30/70

DESCRIPTION	S	WEIGHT POUNDS	C. G. INCHES			INERTIAS SLUG-FT ²			PRODUCTS SLUG-FT ²		
			X	Y	Z	I _{XX}	I _{YY}	I _{ZZ}	P _{XY}	P _{XZ}	P _{YZ}
ASCENT STAGE AT C.S.I.		5820.8	255.7	.4	4.5	3353	3010	2148	54	116	-1
ASCENT STAGE AT DOCKING		5685.7	255.1	.4	4.6	3292	2983	2074	54	119	3
EQUIP. XFR. CM-AS	+	281.4	271.9	-12.2	11.2	33	111	91	20	-34	-4
CM/LM UMBILICAL	+	1.1	300.0	.0	.0	0	0	0	0	0	0
LM EQUIP. RELOC. 4	-	20.0	300.0	.0	.0	0	0	0	0	0	0
LM EQUIP. RELOC. 4	+	20.0	218.5	-19.6	47.6	0	0	0	0	0	0
ONLOAD AT LUN. SITE	-	203.0	268.2	-13.5	-7.1	4	4	8	3	0	0
EQUIP. XFER. AS-CM	-	17.8	260.1	5.9	20.9	4	3	3	0	-1	0
ASCENT STAGE AT JETTISON		5265.3	255.5	.2	2.1	3112	2930	2102	71	113	-18

DISPERSIONS LB/IN			
OX	OY	OZ	
27.2	.8	.1	.1
27.2	.8	.1	.1
.0	.0	.0	.0
.0	.0	.0	.0
.0	.0	.0	.0
.0	.0	.0	.0
.0	.0	.0	.0
.0	.0	.0	.0
27.2	.9	.1	.1

SNA-8-D-027(III)REV 2

Amendment 79
3/30/70

THIS PAGE INTENTIONALLY LEFT BLANK

3.3-10.4

SNA-8-D027(III)REV 2

M M E



NA COORDINATES TABLE 3.3-4
AS-509/CSM 109 LEV DETAIL (TILTEC) MASS PROPERTIES HIGH ALTITUDE ABORT

Amendment 74
1/14/70

DESCRIPTION	S	WEIGHT PCUNDS	C. G. INCHES			INERTIAS SLUG-FT ²			PRODUCTS SLUG-FT ²		
			X	Y	Z	IXX	IYY	IZZ	PXY	PXZ	PYZ
LEV AT ABORT/TIME=0.0 SEC		21422.9	1148.5	.0	3.7	5756	107801	107196	55	-1521	35
0.5		21183.7	1146.2	.0	3.8	6751	106039	105435	55	-1493	35
1.0		20743.9	1143.0	.0	3.8	6744	103713	103109	56	-1454	35
1.5		20323.9	1139.9	.0	3.9	6736	101406	100802	56	-1415	35
2.0		19913.9	1136.7	.0	3.9	6726	99065	98462	56	-1376	35
2.5		19503.6	1133.3	.0	4.0	6715	96630	96028	56	-1336	35
3.0		19159.9	1130.4	.0	4.0	5706	94509	93908	55	-1300	35
3.5		18888.9	1128.1	.0	4.1	6697	92797	92196	55	-1271	35
4.0		18723.9	1126.6	.0	4.1	6692	91727	91127	55	-1253	35
4.5		18578.9	1125.3	.0	4.1	6687	90773	90173	55	-1237	35
5.0		18488.9	1124.4	.0	4.1	6683	90173	89573	55	-1227	35
5.5		18453.9	1124.1	.0	4.2	6682	89938	89339	55	-1223	35
6.0		18418.9	1123.8	.0	4.2	6681	89703	89103	55	-1219	35
6.5		18373.9	1123.4	.0	4.2	6679	89399	88799	55	-1214	35
7.0		18358.9	1123.2	.0	4.2	6679	89297	88698	55	-1212	35
7.5		18343.9	1123.1	.0	4.2	6678	89195	88596	55	-1211	35

DISPERSIONS LB/IN			
DW	DX	DY	DZ
.0	.0	.0	.0
.0	.0	.0	.0
.0	.0	.0	.0
.0	.0	.0	.0
.0	.0	.0	.0
.0	.0	.0	.0
.0	.0	.0	.0
.0	.0	.0	.0
.0	.0	.0	.0
.0	.0	.0	.0
.0	.0	.0	.0
.0	.0	.0	.0
.0	.0	.0	.0
.0	.0	.0	.0
.0	.0	.0	.0
.0	.0	.0	.0
.0	.0	.0	.0
.0	.0	.0	.0
.0	.0	.0	.0

U U U E E E E E E E E E H H H A A A



XA COORDINATES
AS-508/CSM 109 LEV DETAIL (TILTED) MASS PROPERTIES HIGH ALTITUDE ABORT

TABLE 3.3-4 (CONTINUED)

Amendment 74
1/14/70

DESCRIPTION	S	WEIGHT POUNDS	C. G. INCHES			INERTIAS SLUG-FT ²			PRODUCTS SLUG-FT ²		
			X	Y	Z	IXX	IYY	IZZ	PXY	PXZ	PYZ
TIME=8.0 SEC		18374.9	1123.0	.0	4.2	6678	89134	89535	55	-1210	35
8.5		18330.4	1123.0	.0	4.2	6678	89104	88504	55	-1209	35
9.0		18325.9	1122.9	.0	4.2	6678	89073	88473	55	-1209	35
CM W/O DOCK. MECH.	+	12738.1	1040.1	.0	6.2	5888	5186	4646	50	-422	35
FWD. HEAT SHIELD	-	310.0	1054.3	-.5	.8	64	26	23	0	0	0
CM W/O DOCK. MECH. + HEAT SHLD		12028.1	1038.7	.0	6.3	5922	4957	4421	51	-402	35
DRUGUE + DISCONNECTS	-	80.8	1089.0	.0	-23.9	1	1	0	0	0	0
CM AT MAIN CHUTE DEPLOY		11947.3	1038.4	.0	6.5	5805	4895	4377	51	-375	35
PILCT CHUTE + RISERS	-	45.5	1089.9	5.9	-5.9	2	2	1	0	0	0
MAIN CHUTE PACKS	-	401.4	1089.1	.4	8.5	62	22	43	0	0	0
RCS OXID SYSTEM A	-	77.3	1022.6	26.6	59.8	1	0	1	0	0	0
RCS OXID SYSTEM B	-	77.3	1022.6	2.3	65.5	1	0	1	0	0	0
RCS FUEL SYSTEM A	-	43.7	1022.6	-38.7	52.8	0	0	0	0	0	0
RCS FUEL SYSTEM B	-	43.7	1022.6	-52.8	39.7	0	0	0	0	0	0
CM AT IMPACT		11258.4	1036.7	.1	5.4	5546	4462	4009	41	-341	43

DISPERSIONS LB/IN			
DW	DX	DY	DZ
.0	.0	.0	.0
.0	.0	.0	.0
.0	.0	.0	.0
.0	.0	.0	.0
.0	.0	.0	.0
.0	.0	.0	.0
.0	.0	.0	.0
.0	.0	.0	.0
.0	.0	.0	.0
.0	.0	.0	.0
.0	.0	.0	.0
.0	.0	.0	.0
.0	.0	.0	.0
.0	.0	.0	.0
.0	.0	.0	.0
.0	.0	.0	.0
.0	.0	.0	.0
.0	.0	.0	.0
.0	.0	.0	.0
.0	.0	.0	.0
.0	.0	.0	.0
.0	.0	.0	.0

XA CCORDINATES TABLE 3.3-5
AS-508/CSM 1C9 LEV DETAIL (TILTED) MASS PROPERTIES - PAD ABORT

Amendment 74
1/14/70

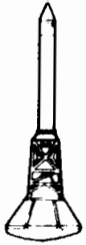

DESCRIPTION	S	WEIGHT POUNDS	C. G. INCHES			INERTIAS SLUG-FT ²			PRODUCTS SLUG-FT ²			DISPERSIONS LB/IN			
			X	Y	Z	IXX	IYY	IZZ	PXY	PXZ	PYZ	DW	DX	DY	DZ
LEV AT ABORT/TIME=0.0 SEC		21522.8	1148.5	.0	3.7	6756	107801	107196	56	-1521	35	.0	.0	.0	.0
0.5		21175.3	1146.2	.0	3.7	6744	106004	105405	60	-1479	34	.0	.0	.0	.0
1.0		20726.7	1143.1	.0	3.8	6729	103647	103054	62	-1428	32	.0	.0	.0	.0
1.5		20298.1	1140.0	.0	3.8	6714	101310	100723	65	-1377	31	.0	.0	.0	.0
2.0		19879.5	1136.9	.0	3.8	6697	98943	98363	68	-1327	29	.0	.0	.0	.0
2.5		19460.7	1133.6	.0	3.9	6680	96484	95911	70	-1275	28	.0	.0	.0	.0
3.0		19107.4	1130.7	.0	3.9	6663	94341	93774	73	-1230	26	.0	.0	.0	.0
3.5		18828.8	1128.4	-.1	3.9	6647	92607	92046	75	-1191	25	.0	.0	.0	.0
4.0		18655.2	1127.0	-.1	3.9	6634	91515	90960	77	-1163	23	.0	.0	.0	.0
4.5		18501.6	1125.7	-.1	3.9	6622	90539	89989	80	-1137	22	.0	.0	.0	.0
5.0		18403.0	1124.9	-.1	3.9	6612	89916	89372	82	-1116	20	.0	.0	.0	.0
5.5		18354.6	1124.7	-.1	3.8	6599	89644	89106	80	-1097	21	.0	.0	.0	.0
6.0		18306.1	1124.4	-.1	3.8	6587	89372	88839	78	-1078	21	.0	.0	.0	.0
6.5		18247.7	1124.1	-.1	3.8	6574	89031	88504	76	-1058	22	.0	.0	.0	.0
7.0		18219.2	1124.0	-.1	3.7	6562	88892	88370	73	-1041	22	.0	.0	.0	.0
7.5		18190.8	1123.9	.0	3.7	6550	88753	88236	71	-1024	22	.0	.0	.0	.0

U
S
N
A
V
Y
A
S
S
E
S
S
M
E
N
T
N
O
. 1
7
7
7

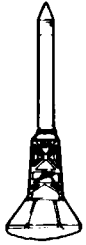

XA COORDINATES TABLE 3.3-5 (CONTINUED)
AS-508/CSM 109 LEV DETAIL (TILTED) MASS PROPERTIES - PAD ABORT

Amendment 74
1/14/70

DESCRIPTION	S	WEIGHT POUNDS	C. G. INCHES			INERTIAS SLUG-FT ²			PRODUCTS SLUG-FT ²		
			X	Y	Z	IXX	IYY	IZZ	PXY	PXZ	PYZ
TIME=8.0		18168.3	1123.9	.0	3.7	6538	88655	88143	69	-1007	23
8.5		18150.4	1124.0	.0	3.6	6527	88586	88090	67	-991	23
9.0		18132.5	1124.0	.0	3.6	6515	88518	88017	65	-975	24
9.5		18127.6	1124.0	.0	3.6	6511	88505	88004	60	-971	26
10.0		18122.7	1124.1	.0	3.6	6507	88492	87991	55	-966	28
10.5		18117.9	1124.1	.0	3.6	6503	88480	87978	50	-962	30
11.0		18113.0	1124.1	.0	3.5	6498	88467	87965	46	-957	32
11.5		18108.2	1124.1	.0	3.5	6494	88454	87952	41	-953	34
12.0		18103.3	1124.2	.0	3.5	6490	88441	87938	36	-948	36
12.5		18098.5	1124.2	.1	3.5	6486	88429	87925	31	-944	38
13.0		18093.6	1124.2	.1	3.5	6482	88416	87912	26	-939	40
13.5		18088.8	1124.2	.1	3.5	6477	88403	87899	21	-935	42
14.0		18083.9	1124.3	.1	3.5	6473	88390	87886	16	-930	44

DISPERSIONS LB/IN			
DW	DX	DY	DZ
.0	.0	.0	.0
.0	.0	.0	.0
.0	.0	.0	.0
.0	.0	.0	.0
.0	.0	.0	.0
.0	.0	.0	.0
.0	.0	.0	.0
.0	.0	.0	.0
.0	.0	.0	.0
.0	.0	.0	.0
.0	.0	.0	.0
.0	.0	.0	.0
.0	.0	.0	.0
.0	.0	.0	.0
.0	.0	.0	.0
.0	.0	.0	.0
.0	.0	.0	.0
.0	.0	.0	.0
.0	.0	.0	.0

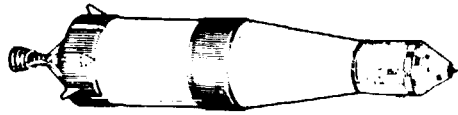

Amendment 74
1/14/70

LV COORDINATES TABLE 3.3-6
S-IVB EXPECTED SEQUENTIAL MASS PROPERTIES

DESCRIPTION	S	WEIGHT POUNDS	C. G. INCHES			INERTIAS SLUG-FT ²			PRODUCTS SLUG-FT ²		
			X	Y	Z	IXX	IYY	IZZ	PXV	PXZ	PYZ
S-IVB POST F.O.I.		221720.0	2834.1	1.1	-0.7	89835	965147	951907			
CSM	+	63754.6	3691.0	4.0	6.5	34794	76383	78979			
LM (IN SLA)	+	33408.4	3341.3	-0.1	-0.2	22445	24766	24898			
S-IVB+CSM+LM POST F.O.I.		288483.0	3173.0	1.5	0.9	147036	9320911	9339855			
S-IVB PRE T.L.I.		198559.0	2831.3	1.1	-0.8	89146	939314	926470			
CSM PRE T.L.I.		63748.9	3691.0	4.0	6.5	34794	76389	78989			
LM (IN SLA)	+	33408.4	3341.3	-0.1	-0.2	22445	24766	24898			
S-IVB+CSM+LM PRE T.L.I.		295716.3	3074.2	1.5	0.8	146358	9318293	9307729			
S-IVB POST T.L.I.		37052.0	2960.0	5.2	-3.7	88527	576448	563228			
CSM POST T.L.I.		63748.9	3691.0	4.0	6.5	34794	76389	78989			
LM (IN SLA)	+	33408.4	3341.3	-0.1	-0.2	22445	24766	24898			
S-IVB+CSM+LM POST T.L.I.		134209.3	3402.7	3.3	2.3	145757	3416090	3405149			
S-IVB(EXCL. SLA PANELS)		31815.0	2882.5	6.2	-4.1	76402	248302	246577			
LM (IN SLA)	+	33408.4	3341.3	-0.1	-0.2	22445	24766	24898			
S-IVB+LM PRE DOCKING		65223.4	3117.0	3.0	-2.1	99070	1013183	1011674			

NOTE: Products of inertia are not presently available for the S-IVB. This table will be updated to include products of inertia when data is available.

SNA-8-D-027(III)REV 2

TABLE 3.3-7

CSM 109 Consumables Weight Change Summary
(To be used in conjunction with the CSM sequential mass properties Table 3.3-2)

EVENT		Consumable	Weight Change (Pounds)	Amount Remaining (Pounds)	Total Usage (Pounds)
From	To				
Earth Launch	Pre Trans/Dock	SM-Hydrogen	-1.1	54.1	-1.1
		SM-Oxygen	-13.0	620.2	-13.0
		CM-Potable H ₂ O	+4.0	40.0	
		CM-Waste H ₂ O ²	+0.8	18.8	
Pre Trans/Dock	Post Trans/Dock	SM-RCS	-70.6	1,272.2	-70.6
Post Trans/Dock	Pre SPS Hybrid	SM-Hydrogen	-5.0	49.1	-6.1
		SM-Oxygen	-59.7	560.5	-72.7
		SM-RCS	-82.1	1,190.1	-152.7
		CM-Waste H ₂ O	+41.2	60.0	
		CM-LiOH	+6.8		
		CM-Food	-3.8		
Pre SPS Hybrid	Post SPS Hybrid	SM-SPS	-159.8	40,406.8	-159.8
Post SPS Hybrid	Pre M.C.C.3	SM-Hydrogen	-4.3	44.8	-10.4
		SM-Oxygen	-40.6	519.9	-113.3
		SM-RCS	-12.0	1,178.1	-164.7
Pre M.C.C.	Post M.C.C	SM-SPS	-344.9	40,061.9	-504.7
Post M.C.C	Pre L.O.I. 1	SM-Hydrogen	-4.4	40.4	-14.8
		SM-Oxygen	-45.9	474.0	-159.2
		SM-RCS	-30.1	1,148.0	-194.8
		CM-Food	-9.4		-13.2
		CM-LiOH	+6.8		
Pre L.O.I.	Post L.O.I.	SM-SPS	-23,510.5	16,551.4	24,015.2
Post L.O.I.	Pre D.O.I.	SM-Hydrogen	-0.8	39.6	-15.6
		SM-Oxygen	-7.8	466.2	-167.0
		SM-RCS	-52.3	1,095.7	-247.1
Pre D.O.I.	Post D.O.I.	SM-SPS	1,537.3	15,014.1	-25,552.5
Post D.O.I.	CSM/LM Separation	SM-Hydrogen	-3.3	36.3	-18.9
		SM-Oxygen	-32.8	433.4	-199.8
		SM-RCS	-73.7	1,022.0	320.8
		CM-LiOH	+5.0		
		CM-Food	-3.8		-17.0
CSM/LM Separation	Pre Circularization	Hydrogen	-0.3	36.0	-19.2
		Oxygen	-2.6	430.8	-202.4
		SM-RCS	-56.6	965.4	-377.4
Pre Circularization	Post Circularization	SM-SPS	-273.0	14,741.1	-25,825.5

M U E E E E E E E E E E E E E E E E

TABLE 3.3-7 (Continued)

CSM 109 Consumables Weight Change Summary
(To be used in conjunction with the CSM sequential mass properties Table 3.3-2)

From	EVENT	To	Consumable	Weight Change (Pounds)	Amount Remaining (Pounds)	Total Usage (Pounds)
Post Circularization	Pre Plane Change 1		SM-Hydrogen	-2.6	33.4	-21.8
			SM-Oxygen	-24.4	406.4	-226.8
			SM-RCS	-73.4	892.0	-450.8
Pre Plane Change 1	Post Plane Change 1	SM-SPS	-679.1	14,062.0	-26,504.6	
Post Plane Change 1	CSM/ASCT Docking		SM-Hydrogen	-5.4	28.0	-27.2
			SM-Oxygen	-51.4	355.0	-278.2
			SM-RCS	-158.9	733.1	-609.7
			CM-Food	-6.3		-23.3
			CM-LIOH	+7.8		
			CM-Fecal	+2.2		
CSM/ASCT Docking	Pre Plane Change 2		SM-Hydrogen	-2.3	25.7	-29.5
			SM-Oxygen	-22.2	332.8	-300.4
			SM-RCS	-39.8	693.3	-649.5
			CM-LIOH	+2.4		
Pre Plane Change 2	Post Plane Change 2	SM-SPS	-2,866.0	11,196.0	-29,370.6	
Post Plane Change 2	Pre T.E.I.		SM-Hydrogen	-2.7	23.0	-32.2
			SM-Oxygen	-25.0	307.8	-325.4
			SM-RCS	-55.0	638.3	-704.5
			CM-Fecal	+1.1		
			CM-Food	-3.8		-27.1
			CM-LIOH	+2.6		
Pre T.E.I.	Post T.E.I.	SM-SPS	8,963.8	2,232.2	-38,334.4	
Post T.E.I.	SM Jettison		SM-Hydrogen	-13.2	9.8	-45.4
			SM-Oxygen	-126.2	181.6	-451.6
			SM-RCS	-206.9	431.4	-911.4
			CM-LIOH	+13.4		
			CM-Food	-10.4		-37.5
			CM-Fecal	+3.3		
SM Jettison	CM @ Entry	CM-RCS	-12.0	233.1	-12.0	
CM @ Entry	CM @ M.C. Deploy	CM-RCS	-31.7	201.4	-43.7	
CM @ M.C. Deploy	CM @ Impact	CM-RCS	-201.4	0.0	-245.1	

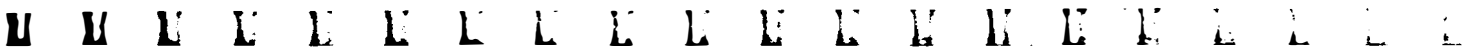

TABLE 3.3-8

LM-7 Consumables Change Summary

(To be used in conjunction with the LM sequential mass properties Table 3-3.2)

EVENT		Consumable	Weight	Amount	Total
From	To		Change (Pounds)	Remaining (Pounds)	Usage (Pounds)
Earth Orbit	CSM/LM Separation	D/S-Oxygen	-2.8	45.2	-2.8
		D/S-Water	-14.8	235.2	-14.8
		LM-RCS	-5.0	599.6	-5.0
CSM/LM Separation	Pre P.D.I.	D/S-Oxygen	-0.9	44.3	-3.7
		D/S-Water	-23.6	211.6	-38.4
		LM-RCS	-53.4	546.2	-58.4
Pre P.D.I.	LM @ Touchdown	D/S-Oxygen	-0.1	44.2	-3.8
		D/S-Water	-1.3	210.3	-39.7
		LM-RCS	-97.0	449.2	-155.4
		LM-DPS	-17,054.5	1,284.4	-17,054.5
LM @ Liftoff	A/S in Orbit	LM-APS	-4,902.4	326.6	-4,902.4
A/S in Orbit	A/S @ C.S.I.	A/S-Water	-15.6	69.4	-15.6
		A/S-Oxygen	-0.5	4.3	-0.5
		LM-RCS	-17.8	431.4	-173.2
A/S @ C.S.I.	A/S @ Docking	A/S Water	-12.9	56.5	-28.5
		A/S Oxygen	-0.6	3.7	-1.1
		LM-RCS	-121.6	309.8	-294.8
A/S @ Docking	A/S Jettison	A/S-Water	-12.4	44.1	-40.9



MISSION "H-2" TRANSFERABLE EQUIPMENT

The reference table used with this transferable equipment list is a directory of information sources from which data for each item were obtained. It is intended to define the exact source of each portion of the data used. This reference table is correlated to each item in the transferable equipment list by a reference code number for each item listed.

Abbreviations used in this reference table are as follows:

C. G.	Center of Gravity
N. R.	North American Rockwell
S. L.	Stowage List
A. O. H.	Apollo Operations Handbook

"DATA" refers to all information, including nomenclature, except that which is designated to separate sources.

"STOWAGE LIST" refers to the Apollo Stowage List for each mission prepared bi-weekly for NASA by the Boeing Company.

"FLIGHT PLAN" refers to the Apollo Flight Plan prepared for each mission by the Flight Planning Branch of NASA.

Data obtained from North American Rockwell and Boeing were obtained through data requests and telephone communication.

REFERENCE USED IN COMPILING TRANSFERRED EQUIPMENT LIST

- 1 Data from S.L./C.G. from N. R.
- 2 Data from S.L./C.G. from Boeing Company
- 3 Data from S.L./C.G. estimated
- 4 Data from S.L./Weight Estimated/C.G. from N. R.
- 5 Data from S.L./C.G. from Mock-up
- 6 Data from S.L./Location from A.O.H./C.G. from N. R.
- 7 Data from S.L./C.G. Calculated from Drawing
- 8 Data for EVA from LM Lunar Surface Checklist
- 9 Data by Telecom. with Responsible MSC Apollo Division/Contractor
- 10 Data from S.L./Weight and C.G. from Boeing Company
- 11 Data from Boeing Co./Location from Flight Plan
- 12 Data from S.L./Weight, Location and C.G. Estimated by TRW
- 13 Data from S.L./Location Estimated/C.G. from N. R.
- 14 Data from Flight Plan/C.G. from N. R.
- 15 Data from A. O. H/C.G. from N. R.
- 20 Data from LM Lunar Surface Checklist/S.L.

SNA-8-D-027(III)REV 2

TABLE 3.3-9
MISSION H COMMAND MODULE STOWAGE VOLUME CENTROIDS
S/C 109 - 111

<u>AREA</u>	<u>X</u>	<u>Y</u>	<u>Z</u>
A1	1012.0	-22.0	-26.0
3	1016.0	-24.0	28.0
4	1015.0	- 7.0	28.0
5	1015.0	9.0	28.0
6	1017.0	26.0	28.0
7 - Not on S/C 110	1012.0	31.0	7.0
8	1012.0	22.0	-23.0
10 - S/C 110 Only	1011.0	23.0	6.0
11 - Not on S/C 110	1011.0	19.0	7.0
12	1013.0	- 9.0	14.0
13	1010.0	-22.0	- 2.0
B1	1050.0	-27.0	39.0
2	1039.0	-38.0	37.0
3	1031.0	-28.0	40.0
4	1031.0	-20.0	40.0
5	1031.0	- 8.0	39.0
6	1031.0	13.0	39.0
7	1033.0	27.0	36.0
8	1024.0	-38.0	37.0
L2	1059.0	-44.0	14.0
3	1048.0	-47.0	12.0
R1	1072.0	26.0	21.0
2	1072.0	26.0	14.0
3	1072.0	26.0	9.0
4	1075.0	28.0	3.0
5	1059.0	44.0	15.0
6	1048.0	46.0	29.0
8	1052.0	46.0	12.0
10 - Forward	1053.0	47.0	5.0
10 - Aft	1047.0	48.0	5.0
11	1038.0	47.0	26.0
13	1024.0	45.0	-26.0
U1	1033.0	23.0	-50.0
3	1033.0	-36.0	-44.0
4	1038.0	39.0	-43.0

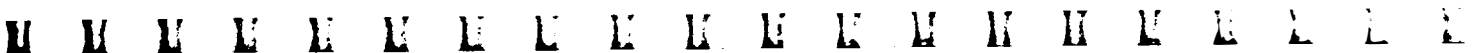

TABLE 3.3-9.1

The following stowage locations have unique volume centroids not associated with stowage volumes.

<u>NOMENCLATURE</u>	<u>LOCATION</u>	<u>X</u>	<u>Y</u>	<u>Z</u>
G&N Signal Cond. Panel	LEB	1069.0	25.0	29.0
Display Keyboard	LEB	1060.0	26.0	32.0
Sleep Restraint Assy - Right	Aft UEB	1018.0	25.0	-47.9
Sleep Restraint Assy - Left	Aft UEB	1018.0	-21.0	-49.9
Food Container	L3	1048.0	-47.0	12.0
Food Container	B1	1050.0	-27.0	39.0
Fecal Stowage Container	RHEB	1039.0	47.0	12.0
PGA Container	On Aft Bulkhead Under Center Couch	1015.0	0.0	-19.9
Forward Hatch Container	Under L.H. Couch	1018.0	-24.5	-15.0
Container, R12 (In-flight Location)	R.H. Girth Ring	1036.5	40.0	-25.0
Helmet Stowage and Accessory Bags (In-flight Location) - L.H.	L.H. Girth Ring	1036.5	-40.0	-25.0
Helmet Stowage and Accessory Bags (In-flight Location) - Ctr.	LEB	1050.0	-27.0	39.0
Helmet Stowage and Accessory Bags (In-flight Location) - R.H.	R.H. Girth Ring	1036.5	40.0	-25.0
Temporary Stowage Bag - L.H. (In-flight Location)	LHEB	1039.0	-47.0	12.0
Temporary Stowage Bag - Ctr. (In-flight Location)	LEB	1050.0	-27.0	39.0
Temporary Stowage Bag - R.H. (In-flight Location)	RHEB	1039.0	47.0	12.0
CO ₂ Absorbers (2)	In ECU	1031.0	-48.3	19.6
CO ₂ Absorbers (4)	A3	1016.5	-23.9	27.5
CO ₂ Absorbers (4)	A4	1015.0	- 8.0	27.5
CO ₂ Absorbers (2)	A6	1016.9	26.2	27.5
CO ₂ Absorbers (4)	B5	1031.0	- 8.0	39.0
CO ₂ Absorbers (4)	B6	1031.0	13.0	39.0
	Composite Location used in Sequential Mass Properties Tables For CO ₂ Absorbed.			
First 6.8 lb. CO ₂ Absorbed	B5	1031.0	- 8.0	39.0
Next 6.8 lb. CO ₂ Absorbed	B6	1031.0	13.0	39.0
Remainder CO ₂ Absorbed	Composite Location	1018.5	-14.3	26.1



Table 3.3-9.2

MISSION H-2 TRANSFERRED CREW AND EQUIPMENT LIST								
ITEMS REARRANGED IN CM PRIOR TO FIRST MID-COURSE CORRECTION (1)								
APOLLO COORDINATES								
DESCRIPTION	STCW. ITEM	REF	NO.	STOWAGE LOCATION	WEIGHT	X-C.G.	Y-C.G.	Z-C.G.
CONTAINER,TEMPCRARY STOW.-CDR.	00301.	1	1	AREA A1	1.7	1012.0	-22.0	-26.0
CONTAINER,TEMPORARY STOW.-CMP.	00301.	1	1	AREA A1	1.7	1012.0	-22.0	-26.0
CONTAINER,TEMPORARY STOW.-LMP.	00301.	1	1	AREA A1	1.7	1012.0	-22.0	-26.0
T-ADAPTER CWG ELECTRICAL-CDR.	80135.	1	1	AREA A8	.4	1012.0	22.0	-23.0
T-ADAPTER CWG ELECTRICAL-CMP.	80135.	1	1	AREA A8	.4	1012.0	22.0	-23.0
T-ADAPTER CWG ELECTRICAL-LMP.	80135.	1	1	AREA A8	.4	1012.0	22.0	-23.0
BAG,MOTION SICKNESS-CDR.	A0208.	1	1	ON CREW-CDR.	.1	1043.0	.0	-11.9
BAG,MOTION SICKNESS-CMP.	A0208.	1	1	ON CREW- CMP	.1	1043.0	-24.5	-11.9
BAG,MOTION SICKNESS-LMP.	A0208.	1	1	ON CREW- LMP	.1	1043.0	24.5	-11.9
PRESSURE GARMENT ASSY.EV.-CDR	80200.	4	1	ON CREW-CDR.	45.0	1043.0	.0	-11.9
PRESSURE GARMENT ASSY.EV.-CMP	80201.	4	1	ON CREW- CMP	35.7	1043.0	-24.5	-11.9
PRESSURE GARMENT ASSY.EV.-LMP	80200.	4	1	ON CREW- LMP	45.0	1043.0	24.5	-11.9
ACCESSORY BAG-CDR.	80105.1	1	1	AREA R6	.3	1048.0	46.0	29.0
ACCESSORY BAG-CMP.	80105.1	1	1	AREA R6	.3	1048.0	46.0	29.0
ACCESSORY BAG-LMP.	80105.1	1	1	AREA R6	.3	1048.0	46.0	29.0
BAG,HELMET STOWAGE-CDR.	80105.	2	1	AREA R6	.9	1048.0	46.0	29.0
BAG,HELMET STOWAGE-CMP.	80105.	2	1	AREA R6	.9	1048.0	46.0	29.0
BAG,HELMET STOWAGE-LMP.	80105.	2	1	AREA R6	.9	1048.0	46.0	29.0
VEST,DUAL LIFE-CDR.	80202.	1	1	ON CREW-CDR	2.4	1043.0	.0	-10.4
VEST,DUAL LIFE-CMP.	80202.	1	1	ON CREW- CMP	2.4	1043.0	-24.5	-10.4
VEST,DUAL LIFE-LMP.	80202.	1	1	ON CREW- LMP	2.4	1043.0	24.5	-10.4
U.C.T.A-CDR.	80205.	4	1	ON CREW-CDR	.5	1043.0	.0	-6.0
U.C.T.A.-CMP.	80205.	4	1	ON CREW- CMP	.5	1043.0	-24.5	-6.0
U.C.T.A-LMP.	80205.	4	1	ON CREW- LMP	.5	1043.0	24.5	-6.0
HEADSET,LIGHTWEIGHT-CDR.	E0104.	1	1	AREA A8	.4	1012.0	22.0	-23.0
HEADSET,LIGHTWEIGHT-CMP.	E0104.1	1	1	AREA A8	.4	1012.0	22.0	-23.0
HEADSET LIGHTWEIGHT-LMP.	E0104.	1	1	AREA A8	.4	1012.0	22.0	-23.0
SLEEP RESTRAINT ASSEMBLY,L.H.	00322.	1	1	AFT UPR EQUIP BAY-LH	3.7	1018.0	-21.9	-49.9
SLEEP RESTRAINT ASSEMBLY,R.H.	00323.	1	1	AFT UPR EQUIP BAY-RH	3.7	1018.0	25.0	-47.9
CONTAINER R12	00344.	1	1	AREA R3	2.7	1072.0	26.0	9.0
JACKET ASSEMBLY,ICG-CDR.	80112.1	1	1	PGA CONTAINER	1.8	1015.0	.0	-19.9
TROUSER ASSEMBLY,ICG-CDR.	80112.2	1	1	PGA CONTAINER	1.8	1015.0	.0	-19.9

NOTE: Further information relating to this table is given on pages 3.3-18, 3.3-19 and 3.3-20.

Table 3.3-9.2 (Continued)

MISSION H-2 TRANSFERRED CREW AND EQUIPMENT LIST								
ITEMS REARRANGED IN CM PRIOR TO FIRST MID-COURSE CORRECTION (1)								
APOLLO COORDINATES								
DESCRIPTION	STOW. ITEM	REF	NO.	STOWAGE LOCATION	WEIGHT	X-C.G.	Y-C.G.	Z-C.G.
BOOT ASSEMBLY RIGHT, ICG-CDR.	B0112.3	1	1	PGA CONTAINER	.4	1015.0	.0	-19.9
BOOT ASSEMBLY LEFT, ICG-CDR.	B0112.4	1	1	PGA CONTAINER	.4	1015.0	.0	-19.9
EARTUBE, UNIVERSAL-CDR.	E0105.1	1	1	ON ICG (PGA CONTAIN)	NEGL	1015.0	.0	-19.0
JACKET ASSEMBLY, ICG-CMP.	R0112.1	1	1	PGA CONTAINER	1.8	1015.0	.0	-19.9
TROUSER ASSEMBLY, ICG-CMP.	B0112.2	1	1	PGA CONTAINER	1.8	1015.0	.0	-19.9
BOOT ASSEMBLY, RIGHT, ICG-CMP.	B0112.3	1	1	PGA CONTAINER	.4	1015.0	.0	-19.9
BOOT ASSEMBLY, LEFT, ICG-CMP.	B0112.4	1	1	PGA CONTAINER	.4	1015.0	.0	-19.9
EARTUBE, UNIVERSAL-CMP.	E0105.	1	1	ON ICG (PGA CONTAIN)	NEGL	1015.0	.0	-19.0
JACKET ASSEMBLY, ICG-LMP.	B0112.1	1	1	PGA CONTAINER	1.8	1015.0	.0	-19.9
TROUSER ASSEMBLY, ICG-LMP.	B0112.2	1	1	PGA CONTAINER	1.8	1015.0	.0	-19.9
BOOT ASSEMBLY, RIGHT, ICG-LMP.	B0112.3	1	1	PGA CONTAINER	.4	1015.0	.0	-19.9
BOOT ASSEMBLY, LEFT, ICG-LMP.	B0112.4	1	1	PGA CONTAINER	.4	1015.0	.0	-19.9
EARTUBE, UNIVERSAL-LMP.	E0105.1	1	1	ON ICG (PGA CONTAIN)	NEGL	1015.0	.0	-19.0
EARPIECE, MOLDED (COM. CAR. I)-CMP	E0200.1	1	2	ON CREW- CMP	NEGL	1043.0	-24.5	-10.4
EARTUBE (COM. CARRIFR)-CMP	E0200.0	1	2	ON CREW- CMP	NEGL	1043.0	-24.5	-10.4
EARPLUGS-CDR.	B0210.	1	2	ON PGA - CDR	NEGL	1043.0	.0	-11.9
EARPLUGS-LMP.	B0210.	1	2	ON PGA - LMP	NEGL	1043.0	24.5	-11.9
PANEL INDICATOR, NOUN LIST	H0104.	1	1	GNIC PANEL	.2	1050.0	.0	22.0
CSM LUNAR LANDMARK MAP	A0114.5	4	1	CONT. R12 (AREA R3)	.6	1072.0	26.0	9.0
CSM SYSTEMS DATA	A0114.7	4	1	CONT. R12 (AREA R3)	.9	1072.0	26.0	9.0
CSM MALFUNCTION PROCEDURES	A0114.8	4	1	CONT. R12 (AREA R3)	.6	1072.0	26.0	9.0
FLIGHT PLAN	A0114.9	4	1	CONT. R12 (AREA R3)	3.0	1072.0	26.0	9.0
CMP SOLC BOOK	A0114.11	4	1	CONT. R12 (AREA R3)	.9	1072.0	26.0	9.0
RESCUE BOOK	A0114.15	4	1	CONT. R12 (AREA R3)	.9	1072.0	26.0	9.0
CM LAUNCH CHECKLIST	A0114.1	4	2	CONT. P12 (AREA R3)	1.0	1072.0	26.0	9.0
CM G AND C CHECKLIST	A0114.2	4	2	CONT. R12 (AREA R3)	1.0	1072.0	26.0	9.0
CM SYSTEMS CHECKLIST	A0114.3	4	2	CONT. R12 (AREA R3)	1.0	1072.0	26.0	9.0
TOTAL INITIAL LOCATION CM					179.20	1040.76	3.76	-12.13

NOTE: Further information relating to this table is given on pages 3.3-18, 3.3-19 and 3.3-20

Table 3.3-9.2 (Continued)

MISSION H-2 TRANSFERRED CREW AND EQUIPMENT LIST								
ITEMS REARRANGED IN CM PRIOR TO FIRST MID-COURSE CORRECTION (2)								
APOLLO COORDINATES								
DESCRIPTION	STOW. ITEM	REF	NO.	STOWAGE LOCATION	WEIGHT	X-C.G.	Y-C.G.	Z-C.G.
CONTAINER,TEMPORARY STOW.-COR.	00301.	1	1	LOWER EQUIP BAY	1.7	1050.0	-27.0	39.0
CONTAINER,TEMPORARY STOW.-CMP.	00301.	1	1	LH GIRTH RING	1.7	1036.5	-40.0	-25.0
CONTAINER,TEMPORARY STOW.-LMP.	00301.	1	1	RH GIRTH RING	1.7	1036.5	40.0	-25.0
T-ADAPTER CWG ELECTRICAL-COR.	80135.	1	1	ON CREW-COR	.4	1043.0	.0	-10.4
T-ADAPTER CWG ELECTRICAL-CMP.	80135.	1	1	ON CREW- CMP	.4	1043.0	-24.5	-10.4
T-ADAPTER CWG ELECTRICAL-LMP.	80135.	1	1	ON CREW- LMP	.4	1043.0	24.5	-10.4
BAG,MOTION SICKNESS-COR.	A0208.	1	1	PGA CONTAINER	.1	1015.0	.0	-19.9
BAG,MOTION SICKNESS-CMP.	A0208.	1	1	PGA CONTAINER	.1	1015.0	.0	-19.9
BAG,MOTION SICKNESS-LMP.	A0208.	1	1	PGA CONTAINER	.1	1015.0	.0	-19.9
ACCESSORY BAG-COR.	80105.1	1	1	LOWER EQUIP BAY	.3	1050.0	-27.0	39.0
ACCESSORY BAG-CMP.	80105.1	1	1	LH EQUIPMENT BAY	.3	1039.0	-47.0	12.0
ACCESSORY BAG-LMP.	80105.1	1	1	RH EQUIPMENT BAY	.3	1039.0	47.0	12.0
BAG,HELMET STOWAGE-COR.	80105.	2	1	LOWER EQUIP BAY	.9	1050.0	-27.0	39.0
BAG,HELMET STOWAGE-CMP.	80105.	2	1	LH EQUIPMENT BAY	.9	1039.0	-47.0	12.0
BAG,HELMET STOWAGE-LMP.	80105.	2	1	RH EQUIPMENT BAY	.9	1039.0	47.0	12.0
VEST,DUAL LIFE-COR.	80202.	1	1	PGA CONTAINER	2.4	1015.0	.0	-19.9
VEST,DUAL LIFE-CMP.	80202.	1	1	PGA CONTAINER	2.4	1015.0	.0	-19.9
VEST,DUAL LIFE-LMP.	80202.	1	1	PGA CONTAINER	2.4	1015.0	.0	-19.9
U.C.T.A-COR.	80205.	4	1	PGA CONTAINER	.5	1015.0	.0	-19.9
U.C.T.A.-CMP.	80205.	4	1	PGA CONTAINER	.5	1015.0	.0	-19.9
U.C.T.A-LMP.	80205.	4	1	PGA CONTAINER	.5	1015.0	.0	-19.9
HEADSET,LIGHTWEIGHT-COR.	E0104.	1	1	ON CREW-COR	.4	1043.0	.0	-10.4
HEADSET,LIGHTWEIGHT-CMP.	E0104.1	1	1	ON CREW- CMP	.4	1043.0	-24.5	-10.4
HEADSET,LIGHTWEIGHT-LMP.	E0104.	1	1	ON CREW- LMP	.4	1043.0	24.5	-10.4
SLEEP RESTRAINT ASSEMBLY,L.H.	00322.	1	1	UNDER LH COUCH	3.7	1018.0	-24.5	-15.0
SLEEP RESTRAINT ASSEMBLY,R.H.	00323.	1	1	UNDER RH COUCH	3.7	1018.0	24.5	-15.0
CONTAINER R12	00344.	1	1	RH GIRTH RING	2.7	1036.5	40.0	-25.0
JACKET ASSEMBLY,ICG-COR.	80112.1	1	1	ON CREW-COR	1.8	1043.0	.0	-10.4
TROUSER ASSEMBLY,ICG-COR.	80112.2	1	1	ON CREW-COR	1.8	1043.0	.0	-10.4
BOOT ASSEMBLY RIGHT,ICG-COR.	80112.3	1	1	ON CREW-COR	.4	1043.0	.0	-10.4
BOOT ASSEMBLY LEFT,ICG-COR.	80112.4	1	1	ON CREW-COR	.4	1043.0	.0	-10.4
EARTUBE,UNIVERSAL-COR.	E0105.1	1	1	ON ICG (ON CREW-COR)	NEGL	1043.0	.0	-10.4

NOTE: Further information relating to this table is given on pages 3.3-18, 3.3-19 and 3.3-20.

Table 3.3-9.2 (Continued)

MISSION H-2 TRANSFERRED CREW AND EQUIPMENT LIST								
ITEMS REARRANGED IN COW PRIOR TO FIRST MID-COURSE CORRECTION (2)								
APOLLO COORDINATES								
DESCRIPTION	STOW. ITEM	REF	NO.	STOWAGE LOCATION	WEIGHT	X-C.G.	Y-C.G.	Z-C.G.
JACKET ASSEMBLY, ICG-CMP.	P0112.1	1	1	ON CREW- CMP	1.8	1043.0	-24.5	-10.4
TROUSER ASSEMBLY, ICG-CMP.	B0112.2	1	1	ON CREW- CMP	1.8	1043.0	-24.5	-10.4
BOOT ASSEMBLY, RIGHT, ICG-CMP.	B0112.3	1	1	ON CREW- CMP	.4	1043.0	-24.5	-10.4
BOOT ASSEMBLY, LEFT, ICG-CMP.	B0112.4	1	1	ON CREW- CMP	.4	1043.0	-24.5	-10.4
EARTUBE, UNIVERSAL-CMP.	E0105.	1	1	ON ICG (ON CREW-CMP)	NEGL	1043.0	-24.5	-10.4
JACKET ASSEMBLY, ICG-LMP.	B0112.1	1	1	ON CREW- LMP	1.8	1043.0	24.5	-10.4
TROUSER ASSEMBLY, ICG-LMP.	B0112.2	1	1	ON CREW- LMP	1.8	1043.0	24.5	-10.4
BOOT ASSEMBLY, RIGHT, ICG-LMP.	B0112.3	1	1	ON CREW- LMP	.4	1043.0	24.5	-10.4
BOOT ASSEMBLY, LEFT, ICG-LMP.	B0112.4	1	1	ON CREW- LMP	.4	1043.0	24.5	-10.4
EARTUBE, UNIVERSAL-LMP.	E0105.1	1	1	ON ICG (ON CREW-LMP)	NEGL	1043.0	24.5	-10.4
TORSO AND LIMB SUIT, IV-CMP.	B0201.1	4	1	PGA CONTAINER	29.9	1015.0	.0	-19.9
PRESSURE HELMET ASSEMBLY-CMP.	B0201.2	12	1	HELMET STOW BAG-CMP	2.4	1039.0	-47.0	12.0
GLOVES, IV, PAIR-CMP.	B0201.3	12	1	ACCESSORY BAG-CMP	1.6	1039.0	-47.0	12.0
COMMUNICATION CARRIER-CMP.	B0201.4	12	1	ACCESSORY BAG-CMP	1.6	1039.0	-47.0	12.0
POCKETS, CHECKLIST+SCISSORS-CMP	B0201.5	4	2	ON ICG (ON CREW-CMP)	.2	1043.0	-24.5	-10.4
TORSO AND LIMB SUIT, EV-CDR	B0200.1	4	1	PGA CONTAINER	39.2	1015.0	.0	-19.9
PRESSURE HELMET ASSEMBLY-CDR.	B0200.2	12	1	HELMET STOW BAG-CDR	2.4	1050.0	-27.0	39.0
GLOVES, IV, PAIR-CDR.	B0200.3	12	1	ACCESSORY BAG-CDR.	1.6	1050.0	-27.0	39.0
COMMUNICATION CARRIER-CDR.	B0200.4	12	1	ACCESSORY BAG-CDR.	1.6	1050.0	-27.0	39.0
POCKETS, CHECKLIST+SCISSORS-CDR	B0200.5	1	2	ON ICG (ON CREW-CDR)	.2	1043.0	.0	-10.4
TORSO AND LIMB SUIT, EV-LMP.	B0200.1	4	1	PGA CONTAINER	39.2	1015.0	.0	-19.9
PRESSURE HELMET ASSEMBLY-LMP	B0200.2	12	1	HELMET STOW BAG-LMP	2.4	1039.0	47.0	12.0
GLOVES, IV, PAIR-LMP	B0200.3	12	1	ACCESSORY BAG-LMP.	1.6	1039.0	47.0	12.0
COMMUNICATION CARRIER-LMP.	B0200.4	12	1	ACCESSORY BAG-LMP.	1.6	1039.0	47.0	12.0
POCKETS, CHECKLIST+SCISSORS-LMP	B0200.5	1	2	ON ICG (ON CREW-LMP)	.2	1043.0	24.5	-10.4
EARPIECE, MOLDED (COM. CAR.)-CMP	E0200.1	1	2	ACCESSORY BAG-CMP	NEGL	1039.0	-47.0	12.0
EARTUBE (COM. CARRIER)-CMP	E0200.0	1	2	ACCESSORY BAG-CMP	NEGL	1039.0	-47.0	12.0
EARPLUGS-CDR.	R0210.	1	2	PGA CONTAINER	NEGL	1015.0	.0	-19.9
EARPLUGS-LMP.	B0210.	1	2	PGA CONTAINER	NEGL	1015.0	.0	-19.9
PANEL INDICATOR, NOUN LIST	H0104.	1	1	AREA R3	.2	1072.0	26.0	9.0
CSM LUNAR LANDMARK MAP	A0114.5	4	1	CONT. R12 (RH GRTH. RG)	.6	1036.5	40.0	-25.0
CSM SYSTEMS DATA	A0114.7	4	1	CONT. R12 (RH GRTH. RG)	.9	1036.5	40.0	-25.0

NOTE: Further information relating to this table is given on pages 3.3-18, 3.3-19 and 3.3-20.

Table 3.3-9.2 (Continued)

Amendment 79
3/30/70

MISSION H-2 TRANSFERRED CREW AND EQUIPMENT LIST								
ITEMS REARRANGED IN CM PRIOR TO FIRST MID-COURSE CORRECTION (2)								
APOLLO COORDINATES								
DESCRIPTION	STOW. ITEM	REF	NO.	STOWAGE LOCATION	WEIGHT	X-C.G.	Y-C.G.	Z-C.G.
CSM MALFUNCTION PROCEDURES	A0114.8	4	1	CONT.R12(RH GRTH.RG)	.6	1036.5	40.0	-25.0
FLIGHT PLAN	A0114.9	4	1	CONT.R12(RH GRTH.RG)	3.0	1036.5	40.0	-25.0
CMF SOLD BOOK	A0114.11	4	1	CONT.R12(RH GRTH.RG)	.9	1036.5	40.0	-25.0
RESCUE BOOK	A0114.15	4	1	CONT.R12(RH GRTH.RG)	.9	1036.5	40.0	-25.0
CM LAUNCH CHECKLIST	A0114.1	4	2	CONT.R12(RH GRTH.RG)	1.0	1036.5	40.0	-25.0
CM G AND C CHECKLIST	A0114.2	4	2	CONT.R12(RH GRTH.RG)	1.0	1036.5	40.0	-25.0
CM SYSTEMS CHECKLIST	A0114.3	4	2	CONT.R12(RH GRTH.RG)	1.0	1036.5	40.0	-25.0
TOTAL RELOCATED CM					179.20	1023.12	1.56	-14.05

NOTE: Further information relating to this table is given on pages 3.3-18, 3.3-19 and 3.3-20

Table 3.3-9.2 (Continued)

MISSION H-2 TRANSFERRED CREW AND EQUIPMENT LIST								
ITEMS REARRANGED IN CM PRIOR TO LM ACTIVATION (3)								
APOLLO COORDINATES								
DESCRIPTION	STOW. ITEM	REF	NO.	STOWAGE LOCATION	WEIGHT	X-C.G.	Y-C.G.	Z-C.G.
T-ADAPTER CWG ELECTRICAL-CDR.	RC135.	1	1	ON CREW-CDR	.4	1043.0	.0	-10.4
T-ADAPTER CWG ELECTRICAL-CMP.	B0135.	1	1	ON CREW- CMP	.4	1043.0	-24.5	-10.4
T-ADAPTER CWG ELECTRICAL-LMP.	B0135.	1	1	ON CREW- LMP	.4	1043.0	24.5	-10.4
U.C.T.A.-CDR.	B0205.	4	1	PGA CONTAINER	.5	1015.0	.0	-19.9
U.C.T.A.-CMP.	B0205.	4	1	PGA CONTAINER	.5	1015.0	.0	-19.9
U.C.T.A.-LMP.	B0205.	4	1	PGA CONTAINER	.5	1015.0	.0	-19.9
HEADSET,LIGHTWEIGHT-CDR.	F0104.	1	1	ON CREW-CDR	.4	1043.0	.0	-10.4
HEADSET,LIGHTWEIGHT-CMP.	E0104.1	1	1	ON CREW- CMP	.4	1043.0	-24.5	-10.4
HEADSET LIGHTWEIGHT-LMP.	E0104.	1	1	ON CREW- LMP	.4	1043.0	24.5	-10.4
JACKET ASSEMBLY,ICG-CDR.	B0112.1	1	1	ON CREW-CDR	1.8	1043.0	.0	-10.4
TROUSER ASSEMBLY,ICG-CDR.	B0112.2	1	1	ON CREW-CDR	1.8	1043.0	.0	-10.4
BOOT ASSEMBLY RIGHT,ICG-CDR.	B0112.3	1	1	ON CREW-CDR	.4	1043.0	.0	-10.4
BOOT ASSEMBLY LEFT,ICG-CDR.	B0112.4	1	1	ON CREW-CDR	.4	1043.0	.0	-10.4
EARTUBE,UNIVERSAL-CDR.	E0105.1	1	1	ON ICG (ON CREW-CDR)	NEGL	1043.0	.0	-10.4
JACKET ASSEMBLY,ICG-CMP.	B0112.1	1	1	ON CREW- CMP	1.8	1043.0	-24.5	-10.4
TROUSER ASSEMBLY,ICG-CMP.	B0112.2	1	1	ON CREW- CMP	1.8	1043.0	-24.5	-10.4
BOOT ASSEMBLY,RIGHT,ICG-CMP.	B0112.3	1	1	ON CREW- CMP	.4	1043.0	-24.5	-10.4
BOOT ASSEMBLY,LEFT,ICG-CMP.	B0112.4	1	1	ON CREW- CMP	.4	1043.0	-24.5	-10.4
EARTUBE,UNIVERSAL-CMP.	EC105.	1	1	ON ICG (ON CREW-CMP)	NEGL	1043.0	-24.5	-10.4
JACKET ASSEMBLY,ICG-LMP.	B0112.1	1	1	ON CREW- LMP	1.8	1043.0	24.5	-10.4
TROUSER ASSEMBLY,ICG-LMP.	B0112.2	1	1	ON CREW- LMP	1.8	1043.0	24.5	-10.4
BOOT ASSEMBLY,RIGHT,ICG-LMP.	B0112.3	1	1	ON CREW- LMP	.4	1043.0	24.5	-10.4
BOOT ASSEMBLY,LEFT,ICG-LMP.	B0112.4	1	1	ON CREW- LMP	.4	1043.0	24.5	-10.4
EARTUBE,UNIVERSAL-LMP.	E0105.1	1	1	ON ICG (ON CREW-LMP)	NEGL	1043.0	24.5	-10.4
TORSO AND LIMB SUIT,IV-CMP.	B0201.1	4	1	PGA CONTAINER	29.9	1015.0	.0	-19.9
PRESSURE HELMET ASSEMBLY-CMP.	B0201.2	12	1	HELMET STOW BAG-CMP	2.4	1039.0	-47.0	12.0
GLOVES,IV,PAIR-CMP.	B0201.3	12	1	ACCESSORY BAG-CMP	1.6	1039.0	-47.0	12.0
COMMUNICATION CARRIER-CMP.	B0201.4	12	1	ACCESSORY BAG-CMP	1.6	1039.0	-47.0	12.0
POCKETS,CHECKLIST+SCISSORS-CMP	B0201.5	4	2	ON ICG (ON CREW-CMP)	.2	1043.0	-24.5	-10.4
COMMUNICATION CARRIER-CDR.	B0200.4	12	1	ACCESSORY BAG-CDR.	1.6	1050.0	-27.0	39.0
POCKETS,CHECKLIST+SCISSORS-CDR	B0200.5	1	2	ON ICG (ON CREW-CDR)	.2	1043.0	.0	-10.4
COMMUNICATION CARRIER-LMP.	B0200.4	12	1	ACCESSORY BAG-LMP.	1.6	1039.0	47.0	12.0

NOTE: Further information relating to this table is given on pages 3.3-18, 3.3-19 and 3.3-20.

Table 3.3-9.2 (Continued)

MISSION H-2 TRANSFERRED CREW AND EQUIPMENT LIST								
ITEMS REARRANGED IN CM PRIOR TO LM ACTIVATION (3)							APOLLO COORDINATES	
DESCRIPTION	STOW. ITEM	REF	NO.	STOWAGE LOCATION	WEIGHT	X-C.G.	Y-C.G.	Z-C.G.
POCKETS,CHECKLIST+SCISSORS-LMP	80200.5	1	2	ON ICG (ON CREW-LMP)	.2	1043.0	24.5	-10.4
GARMENT,CONSTANT WEAR-CDR.	80208.	6	1	ON CREW-CDR	.8	1043.0	.0	-10.4
GARMENT,CONSTANT WEAR-LMP.	80208.	6	1	ON CREW- LMP	.8	1043.0	24.5	-10.4
EARPIECE,MOLDED(COM. CAR.)-CMP	E0200.1	1	2	ACCESSORY BAG-CMP	NEGL	1039.0	-47.0	12.0
EARTUBE (COM. CARRIER)-CMP	E0200.0	1	2	ACCESSORY BAG-CMP	NEGL	1039.0	-47.0	12.0
EARPLUGS-CDR.	80210.	1	2	PGA CONTAINER	NEGL	1015.0	.0	-19.9
EARPLUGS-LMP.	80210.	1	2	PGA CONTAINER	NEGL	1015.0	.0	-19.9
TOTAL INITIAL LOCATION CM					58.00	1027.54	-3.65	-11.40

NOTE: Further information relating to this table is given on pages 3.3-18, 3.3-19 and 3.3-20

Table 3.3-9.2 (Continued)

MISSION H-2 TRANSFERRED CREW AND EQUIPMENT LIST								
ITEMS REARRANGED IN CM PRIOR TO LM ACTIVATION (4)								
APOLLO COORDINATES								
DESCRIPTION	STOW. ITEM	REF	NO.	STOWAGE LOCATION	WEIGHT	X-C.G.	Y-C.G.	Z-C.G.
T-ADAPTER CWG ELECTRICAL-COR.	80135.	1	1	AREA A8	.4	1012.0	22.0	-23.0
T-ADAPTER CWG ELECTRICAL-CMP.	80135.	1	1	AREA A8	.4	1012.0	22.0	-23.0
T-ADAPTER CWG ELECTRICAL-LMP.	80135.	1	1	AREA A8	.4	1012.0	22.0	-23.0
U.C.T.A.-CDR.	80205.	4	1	ON CREW-COR	.5	1043.0	.0	-6.0
U.C.T.A.-CMP.	80205.	4	1	ON CREW- CMP	.5	1043.0	-24.5	-6.0
U.C.T.A.-LMP.	80205.	4	1	ON CREW- LMP	.5	1043.0	24.5	-6.0
HEADSET, LIGHTWEIGHT-COR.	E0104.	1	1	AREA A8	.4	1012.0	22.0	-23.0
HEADSET, LIGHTWEIGHT-CMP.	E0104.1	1	1	AREA A8	.4	1012.0	22.0	-23.0
HEADSET LIGHTWEIGHT-LMP.	E0104.	1	1	AREA A8	.4	1012.0	22.0	-23.0
JACKET ASSEMBLY, ICG-COR.	80112.1	1	1	PGA CONTAINER	1.8	1015.0	.0	-19.9
TROUSER ASSEMBLY, ICG-COR.	80112.2	1	1	PGA CONTAINER	1.8	1015.0	.0	-19.9
BOOT ASSEMBLY RIGHT, ICG-COR.	80112.3	1	1	PGA CONTAINER	.4	1015.0	.0	-19.9
BOOT ASSEMBLY LEFT, ICG-COR.	80112.4	1	1	PGA CONTAINER	.4	1015.0	.0	-19.9
EARTUBE, UNIVERSAL-COR.	E0105.1	1	1	ON ICG (PGA CONTAIN)	NEGL	1015.0	.0	-19.0
JACKET ASSEMBLY, ICG-CMP.	80112.1	1	1	PGA CONTAINER	1.8	1015.0	.0	-19.9
TROUSER ASSEMBLY, ICG-CMP.	80112.2	1	1	PGA CONTAINER	1.8	1015.0	.0	-19.9
BOOT ASSEMBLY, RIGHT, ICG-CMP.	80112.3	1	1	PGA CONTAINER	.4	1015.0	.0	-19.9
BOOT ASSEMBLY, LEFT, ICG-CMP.	80112.4	1	1	PGA CONTAINER	.4	1015.0	.0	-19.9
EARTUBE, UNIVERSAL-CMP.	E0105.	1	1	ON ICG (PGA CONTAIN)	NEGL	1015.0	.0	-19.0
JACKET ASSEMBLY, ICG-LMP.	80112.1	1	1	PGA CONTAINER	1.8	1015.0	.0	-19.9
TROUSER ASSEMBLY, ICG-LMP.	80112.2	1	1	PGA CONTAINER	1.8	1015.0	.0	-19.9
BOOT ASSEMBLY, RIGHT, ICG-LMP.	80112.3	1	1	PGA CONTAINER	.4	1015.0	.0	-19.9
BOOT ASSEMBLY, LEFT, ICG-LMP.	80112.4	1	1	PGA CONTAINER	.4	1015.0	.0	-19.9
EARTUBE, UNIVERSAL-LMP.	E0105.1	1	1	ON ICG (PGA CONTAIN)	NEGL	1015.0	.0	-19.0
TORSO AND LIMB SUIT, IV-CMP.	80201.1	4	1	ON CREW- CMP	29.9	1043.0	-24.5	-10.4
PRESSURE HELMET ASSEMBLY-CMP.	80201.2	12	1	ON CREW- CMP	2.4	1043.0	-24.5	-10.4
GLOVES, IV, PAIR-CMP.	80201.3	12	1	ON CREW- CMP	1.6	1043.0	-24.5	-10.4
COMMUNICATION CARRIER-CMP.	80201.4	12	1	ON CREW- CMP	1.6	1043.0	-24.5	-10.4
POCKETS, CHECKLIST+SCISSORS-CMP	80201.5	4	2	ON PGA - CMP	.2	1043.0	-24.5	-11.9
COMMUNICATION CARRIER-CDR.	80200.4	12	1	ON CREW-CDR	1.6	1043.0	.0	-10.4
POCKETS, CHECKLIST+SCISSORS-CDR	80200.5	1	2	ON PGA - CDR	.2	1042.8	.0	-20.8
COMMUNICATION CARRIER-LMP.	80200.4	12	1	ON CREW- LMP	1.6	1043.0	24.5	-10.4

NOTE: Further information relating to this table is given on pages 3.3-18, 3.3-19 and 3.3-20.

Table 3.3-9.2 (Continued)

Amendment 79
3/30/70

MISSION H-2 TRANSFERRED CREW AND EQUIPMENT LIST									
ITEMS REARRANGED IN CM PRIOR TO LM ACTIVATION (4)							APOLLO COORDINATES		
DESCRIPTION	STOW. ITEM	REF	NO.	STOWAGE LOCATION	WEIGHT	X-C.G.	Y-C.G.	Z-C.G.	
POCKETS,CHECKLIST+SCISSORS-LMP	R0200.5	1	2	ON PGA - LMP	.2	1051.6	24.5	-10.1	
GARMENT,CONSTANT WEAR-CDR.	B0208.	6	1	AREA AB	.8	1012.0	22.0	-23.0	
GARMENT,CONSTANT WEAR-LMP.	B0208.	6	1	AREA AB	.8	1012.0	22.0	-23.0	
EARPIECE,MOLDED(COM. CAR.)-CMP	E0200.1	1	2	ON CREW- CMP	NEGL	1043.0	-24.5	-10.4	
EARTUBE (COM. CARRIER)-CMP	E0200.0	1	2	ON CREW- CMP	NEGL	1043.0	-24.5	-10.4	
EARPLUGS-CDR.	B0210.	1	2	ON PGA - CDR	NEGL	1043.0	.0	-11.9	
EARPLUGS-LMP.	B0210.	1	2	ON PGA - LMP	NEGL	1043.0	24.5	-11.9	
TOTAL RELOCATED CM					58.00	1034.52	-12.80	-13.36	

NOTE: Further information relating to this table is given on pages 3.3-18, 3.3-19 and 3.3-20

Table 3.3-9.2 (Continued)

MISSION H-2 TRANSFERRED CREW AND EQUIPMENT LIST								
ITEMS INITIALLY IN CM TRANSFERRED TO LM AT LM ACTIVATION (28)								APOLLO COORDINATES
DESCRIPTION	STOW. ITEM	REF	NC.	STOWAGE LOCATION	WEIGHT	X-C.G.	Y-C.G.	Z-C.G.
MAG.,16MM DATA ACQUISITION	A0101.1	12	1	APEA AB	1.0	1012.0	22.0	-23.0
COMMUNICATION CARRIER-COR.	80200.4	12	1	ON CREW-COR	1.6	1043.0	.0	-10.4
COMMUNICATION CARRIER-LMP.	80200.4	12	1	ON CREW- LMP	1.6	1043.0	24.5	-10.4
MAGAZINE,LUNAR SURF.HASSELBLAD	A0108.1	1	2	IN 70MM MAG BAG(R13)	2.8	1022.0	45.0	-24.0
BAG,70MM MAG.(LM XFR)	06367	1	1	AREA R13	.2	1024.0	45.0	-26.0
EARPLUGS-COR.	80210.	1	2	ON PGA - COR	NEGL	1043.0	.0	-11.9
EARPLUGS-LMP.	80210.	1	2	ON PGA - LMP	NEGL	1043.0	24.5	-11.9
DISPENSER, TISSUE	80103.	1	1	APEA AB	1.4	1012.0	22.0	-23.0
LM SYS. ACTIVATION CHECKLIST	A0114.12	1	1	AREA R3	.5	1072.0	26.0	9.0
POWER PACK,16MM BAT.OPERAT.CAM	A0155.4	12	1	AREA AB	3.3	1012.0	22.0	-23.0
CAMERA,16MM BATTERY OPERATED	A0155.1	12	1	AREA AB	3.0	1012.0	22.0	-23.0
LENS 10MM,16MM BAT.OPERAT.CAM.	A0155.2	12	1	AREA AB	.5	1012.0	22.0	-23.0
HANDLE,16MM BAT.OPERATED CAMR.	A0155.3	12	1	AREA AB	.8	1012.0	22.0	-23.0
BKKT,RCU,16MM BAT.OPERAT.CAMR.	A0155.5	12	1	APEA AB	.3	1012.0	22.0	-23.0
TOTAL INITIAL LOCATION CM					17.00	1021.39	24.34	-19.89

NOTE: Further information relating to this table is given on pages 3.3-18, 3.3-19 and 3.3-20

Table 3.3-9.2 (continued)

MISSION H-2 TRANSFERRED CREW AND EQUIPMENT LIST								
ITEMS INITIALLY IN CM TRANSFERRED TO LM AT LM ACTIVATION (29)								
DESCRIPTION	STCW. ITEM	REF	NO.	STORAGE LOCATION	WEIGHT	LM COORDINATES		
						X-C.G.	Y-C.G.	Z-C.G.
MAG., 16MM DATA ACQUISITION	A0101.1	12	1	TBD-6 (ESTIMATED)	1.0	256.0	1.2	34.3
COMMUNICATION CARRIER-CDR.	RC200.4	12	1	ON CREW (LH CREW STA)	1.6	250.6	-22.0	43.4
COMMUNICATION CARRIER-LMP.	RC200.4	12	1	ON CREW (RH CREW STA)	1.6	250.6	22.0	43.4
MAGAZINE, LUNAR SURF. HASSELBLAD	A0108.1	1	2	ISA (LH MID-SEC. SHLF)	2.8	270.3	-15.0	19.0
BAG, 70MM MAG. (LM XFR)	O6367	1	1	ISA (LH MID-SEC. SHLF)	.2	270.3	-15.0	19.0
EARPLUGS-CDR.	B0210.	1	2	ON PGA-CDR (ON CREW)	NEGL	250.6	-22.0	43.4
EARPLUGS-LMP.	RC210.	1	2	ON PGA-LMP (ON CREW)	NEGL	250.6	22.0	43.4
DISPENSER, TISSUE	B0103.	1	1	RH SIDE STOW. COMPT.	1.4	238.4	38.6	46.0
LM SYS. ACTIVATION CHECKLIST	A0114.12	1	1	DATA CARD KIT (FDF)	.5	280.8	-20.0	14.0
POWER PACK, 16MM BAT. OPERAT. CAM	A0155.4	12	1	TBD-6 (ESTIMATED)	3.3	256.0	1.2	34.3
CAMERA, 16MM BATTERY OPERATED	A0155.1	12	1	TBD-6 (ESTIMATED)	3.0	256.0	1.2	34.3
LENS 10MM, 16MM BAT. OPERAT. CAM.	A0155.2	12	1	TBD-6 (ESTIMATED)	.5	256.0	1.2	34.3
HANDLE, 16MM BAT. OPERATED CAM.	A0155.3	12	1	TBD-6 (ESTIMATED)	.8	256.0	1.2	34.3
BRKT, RCU, 16MM BAT. OPERAT. CAM.	A0155.5	12	1	TBD-6 (ESTIMATED)	.3	256.0	1.2	34.3
TOTAL LOCATION LM					17.00	256.79	.57	33.68

NOTE: Further information relating to this table is given on pages 3.3-18, 3.3-19 and 3.3-20

Table 3.3-9.2 (Continued)

MISSION H-2 TRANSFERRED CREW AND EQUIPMENT LIST								
ITEMS INITIALLY IN CM TRANSFERRED TO LM AT LM ACTIVATION THEN BACK TO CM PRIOR TO A/S JETTISON (5) APOLLO COORDINATES								
DESCRIPTION	STOW. ITEM	REF	NO.	STORAGE LOCATION	WEIGHT	X-C.G.	Y-C.G.	Z-C.G.
BAG,MOTION SICKNESS-CCR.	A0208.	1	1	PGA CONTAINER	.1	1015.0	.0	-19.9
BAG,MOTION SICKNESS-LMP.	A0208.	1	1	PGA CONTAINER	.1	1015.0	.0	-19.9
U.C.T.A-CDR.	B0205.	4	1	ON CREW-CDR	.5	1043.0	.0	-6.0
U.C.T.A-LMP.	B0205.	4	1	ON CREW- LMP	.5	1043.0	24.5	-6.0
MAG.,16MM DATA ACQUISITION	A0101.1	12	1	AREA AB	1.0	1012.0	22.0	-23.0
TORSO AND LIMB SUIT,EV-CDR	B0200.1	4	1	PGA CONTAINER	39.2	1015.0	.0	-19.9
PRESSURE HELMET ASSEMBLY-CDR.	B0200.2	12	1	HELMET STOW BAG-CDR	2.4	1050.0	-27.0	39.0
GLOVES,IV,PAIR-CDR.	B0200.3	12	1	ACCESSORY BAG-CDR.	1.6	1050.0	-27.0	39.0
POCKETS,CHECKLIST+SCISSORS-CDR	B0200.5	1	2	ON PGA - CDR	.2	1042.8	.0	-20.8
TORSO AND LIMB SUIT,EV-LMP.	B0200.1	4	1	PGA CONTAINER	39.2	1015.0	.0	-19.9
PRESSURE HELMET ASSEMBLY-LMP	B0200.2	12	1	HELMET STOW BAG-LMP	2.4	1039.0	47.0	12.0
GLOVES,IV,PAIR-LMP	B0200.3	12	1	ACCESSORY BAG-LMP.	1.6	1039.0	47.0	12.0
POCKETS,CHECKLIST+SCISSORS-LMP	B0200.5	1	2	ON PGA - LMP	.2	1051.6	24.5	-10.1
MAG.,16MM DATA ACQUISITION	A0101.1	1	6	AREA R13	6.0	1024.0	45.0	-26.0
MAGAZINE,LUNAR SURF,HASSELBLAD	A0108.1	1	3	IN 70MM MAG BAG(R13)	4.2	1022.0	45.0	-24.0
DOSIMETER,PASSIVE RADIATION	00101.	4	1	IN 16MM MAG.BAG(R13)	NEGL	1024.0	45.0	-26.0
BAG,STOW.+XFR-16MM MAG.	00380.	1	1	AREA R13	.2	1024.0	45.0	-26.0
BAG, 70MM MAGAZINE	00381.	1	1	AREA R13	.3	1024.0	45.0	-26.0
SUNGLASSES-CDR.	A0200.	2	1	ON CREW-CDR	.1	1043.0	.0	-10.4
SUNGLASSES-LMP.	A0200.	2	1	ON CREW- LMP	.1	1043.0	24.5	-10.4
POUCH,SUNGLASSES-CDR.	A0201.	2	1	ON CREW-CDR	NEGL	1043.0	.0	-10.4
POUCH,SUNGLASSES-LMP.	A0201.	2	1	ON CREW- LMP	NEGL	1043.0	24.5	-10.4
CHRONOGRAPH-CDR.	A0202.	2	1	ON CREW-CDR	.1	1043.0	.0	-10.4
CHRONOGRAPH-LMP.	A0202.	2	1	ON CREW- LMP	.1	1043.0	24.5	-10.4
WATCHBAND-CDR.	A0203.	2	1	ON CREW-CDR	NEGL	1043.0	.0	-10.4
WATCHBAND-LMP.	A0203.	2	1	ON CREW- LMP	NEGL	1043.0	24.5	-10.4
PENS,DATA RECORDING-CDR.	A0204.	2	1	ON CREW-CDR	.1	1043.0	.0	-10.4
PENS,DATA RECORDING-LMP.	A0204.	2	1	ON CREW- LMP	.1	1043.0	24.5	-10.4
PENS,MARKER-CDR.	A0205.	2	1	ON CREW-CDR	NEGL	1043.0	.0	-10.4
PENS,MARKER-LMP.	A0205.	2	1	ON CREW- LMP	NEGL	1043.0	24.5	-10.4
PENCIL-CDR.	A0206.	2	1	ON CREW-CDR	.1	1043.0	.0	-10.4
PENCIL-LMP.	A0206.	2	1	ON CREW- LMP	.1	1043.0	24.5	-10.4

NOTE: Further information relating to this table is given on pages 3.3-18, 3.3-19 and 3.3-20.

Table 3.3-9.2 (Continued)

MISSION H-2 TRANSFERRED CREW AND EQUIPMENT LIST								
ITEMS INITIALLY IN CM TRANSFERRED TO LM AT LM ACTIVATION THEN BACK TO CM PRIOR TO A/S JETTISON (5) APOLLO COORDINATES								
DESCRIPTION	STOW. ITEM	REF	NO.	STOWAGE LOCATION	WEIGHT	X-C.G.	Y-C.G.	Z-C.G.
BIOINSTRUMENTATION ASSY-COR.	B0203.	2	1	ON CREW-CDR	1.1	1041.0	.0	-13.0
BIOINSTRUMENTATION ASSY-LMP.	B0203.	2	1	ON CREW- LMP	1.1	1041.0	24.5	-13.0
BIOBELT ASSEMBLY-COR.	B0207.	2	1	ON CREW-COR	.2	1041.0	.0	-13.0
BIOBELT ASSEMBLY-LMP.	B0207.	2	1	ON CREW- LMP	.2	1041.0	24.5	-13.0
SCISSORS	B0204.	2	1	ON CREW-CDR	.5	1043.0	.0	-10.4
BAG,STOW.+XFR-16MM MAG.	O6393.	4	1	AREA A8	.2	1012.0	22.0	-23.0
PENLIGHTS-CDR.	R0206.	2	1	ON CREW-CDR	.3	1043.0	.0	-10.4
PENLIGHTS-LMP.	B0206.	2	1	ON CREW- LMP	.3	1043.0	24.5	-10.4
DOSIMETER,PASSIVE-CDR.	D0201.	1	3	ON PGA - CDR	NEGL	1043.0	.0	-11.9
DOSIMETER,PASSIVE-LMP.	D0201.	1	3	ON PGA - LMP	NEGL	1043.0	24.5	-11.9
DOSIMETER,PERSONAL-COR.	D0200.	2	1	ON CREW-CDR	.4	1043.0	.0	-10.4
DOSIMETER,PERSONAL-LMP.	D0200.	2	1	ON CREW- LMP	.4	1043.0	24.5	-10.4
GARMENT,LIQUID COOLED-COR.	B0107.	1	1	AREA U1	4.2	1033.0	23.0	-50.0
GARMENT,LIQUID COOLED-LMP.	B0107.	1	1	AREA U1	4.2	1033.0	23.0	-50.0
FECAL CONTAINER SUBSYSTEM-CDR.	B0113.	1	1	AREA U1	.3	1033.0	23.0	-50.0
FECAL CONTAINER SUBSYSTEM-LMP.	B0113.	1	1	AREA U1	.3	1033.0	23.0	-50.0
CREW-COMMANDER	T8D	10	1	CENTER COUCH	178.0	1043.0	.0	-10.4
CREW-LM PILOT	T8D	10	1	RIGHT COUCH	170.0	1043.0	24.5	-10.4
LM LUNAR SURFACE CHECKLIST	A0114.10	1	1	AREA R3	1.0	1072.0	26.0	9.0
LM SYS. ACTIVATION CHECKLIST	A0114.12	1	1	AREA R3	.5	1072.0	26.0	9.0
LM LUNAR SURFACE MAPS	A0114.13	1	1	AREA R3	1.0	1072.0	26.0	9.0
LM TIMELINE BCGK	A0114.14	1	1	AREA R3	1.0	1072.0	26.0	9.0
LM XFR. DATA CARD KIT	A0114.18	1	1	AREA R3	1.0	1072.0	26.0	9.0
LM DATA CARD BCGK	A0114.19	1	1	AREA R3	1.0	1072.0	26.0	9.0
CHART C,ORBITAL SCIENCE	A0114.22	1	1	AREA R3	1.0	1072.0	26.0	9.0
CHART,LM ORBIT MONITOR	A0114.29	4	1	AREA R3	1.0	1072.0	26.0	9.0
TOTAL INITIAL LOCATION CM					469.70	1038.07	11.14	-12.21

NOTE: Further information relating to this table is given on pages 3.3-18, 3.3-19 and 3.3-20

Table 3.3-9.2 (Continued)

MISSION H-2 TRANSFERRED CREW AND EQUIPMENT LIST								
ITEMS INITIALLY IN CM TRANSFERRED TO LM AT LM ACTIVATION THEN BACK TO CM PRIOR TO A/S JETTISON (6) LM COORDINATES								
DESCRIPTION	STOW. ITEM	REF	NO.	STOWAGE LOCATION	WEIGHT	X-C.G.	Y-C.G.	Z-C.G.
BAG,MOTION SICKNESS-CDR.	A0208.	1	1	ON PGA-CDR (CM CREW)	.1	250.6	-22.0	43.4
BAG,MOTION SICKNESS-LMP.	A0209.	1	1	ON PGA-LMP (ON CREW)	.1	250.6	22.0	43.4
U.C.T.A-CDR.	80205.	4	1	ON CREW(LH CREW STA)	.5	250.6	-22.0	43.4
U.C.T.A-LMP.	80205.	4	1	ON CREW(RH CREW STA)	.5	250.6	22.0	43.4
MAG.,16MM DATA ACQUISITION	A0101.1	12	1	TBD-6 (ESTIMATED)	1.0	256.0	1.2	34.3
TORSO AND LIMB SUIT,EV-CDR	80200.1	4	1	ON CREW(LH CREW STA)	39.2	250.6	-22.0	43.4
PRESSURE HELMET ASSEMBLY-CDR.	80200.2	12	1	ON CREW(LH CREW STA)	2.4	250.6	-22.0	43.4
GLOVES,IV,PAIR-CDR.	80200.3	12	1	ON CREW(LH CREW STA)	1.6	250.6	-22.0	43.4
POCKETS,CHECKLIST+SCISSORS-CDR	80200.5	1	2	ON CREW(LH CREW STA)	.2	250.6	-22.0	43.4
TORSO AND LIMB SUIT,EV-LMP.	80200.1	4	1	ON CREW(RH CREW STA)	39.2	250.6	22.0	43.4
PRESSURE HELMET ASSEMBLY-LMP	80200.2	12	1	ON CREW(RH CREW STA)	2.4	250.6	22.0	43.4
GLDVES,IV,PAIR-LMP	80200.3	12	1	ON CREW(RH CREW STA)	1.6	250.6	22.0	43.4
POCKETS,CHECKLIST+SCISSORS-LMP	80200.5	1	2	ON CREW(RH CREW STA)	.2	250.6	22.0	43.4
MAG.,16MM DATA ACQUISITION	A0101.1	1	6	16MM MAG.BAG(RHSSC)	6.0	238.4	38.6	46.0
MAGAZINE,LUNAR SURF.HASSELBLAD	A0108.1	1	3	70MM MAG.BAG(RHSSC)	4.2	238.4	38.6	46.0
DOSIMETER,PASSIVE RADIATION	D0101.	4	1	16MM MAG.BAG(RHSSC)	NEGL	238.4	38.6	46.0
BAG,STOW.+XFR-16MM MAG.	00380.	1	1	RH SIDE STOW.COMPT.	.2	238.4	38.6	46.0
BAG, 70MM MAGAZINE	00381.	1	1	RH SIDE STOW.COMPT.	.3	238.4	38.6	46.0
SUNGLASSES-CDR.	A0200.	2	1	ON CREW(LH CREW STA)	.1	250.6	-22.0	43.4
SUNGLASSES-LMP.	A0200.	2	1	ON CREW(RH CREW STA)	.1	250.6	22.0	43.4
POUCH,SUNGLASSES-CDR.	A0201.	2	1	ON CREW(LH CREW STA)	NEGL	250.6	-22.0	43.4
POUCH,SUNGLASSES-LMP.	A0201.	2	1	ON CREW(RH CREW STA)	NEGL	250.6	22.0	43.4
CHRONOGRAPH-CDR.	A0202.	2	1	ON CREW(LH CREW STA)	.1	250.6	-22.0	43.4
CHRONOGRAPH-LMP.	A0202.	2	1	ON CREW(RH CREW STA)	.1	250.6	22.0	43.4
WATCHBAND-CDR.	A0203.	2	1	ON CREW(LH CREW STA)	NEGL	250.6	-22.0	43.4
WATCHBAND-LMP.	A0203.	2	1	ON CREW(RH CREW STA)	NEGL	250.6	22.0	43.4
PENS,DATA RECORDING-CDR.	A0204.	2	1	ON CREW(LH CREW STA)	.1	250.6	-22.0	43.4
PENS,DATA RECORDING-LMP.	A0204.	2	1	ON CREW(RH CREW STA)	.1	250.6	22.0	43.4
PENS,MARKER-CDR.	A0205.	2	1	ON CREW(LH CREW STA)	NEGL	250.6	-22.0	43.4
PENS,MARKER-LMP.	A0205.	2	1	ON CREW(RH CREW STA)	NEGL	250.6	22.0	43.4
PENCIL-CDR.	A0206.	2	1	ON CREW(LH CREW STA)	.1	250.6	-22.0	43.4
PENCIL-LMP.	A0206.	2	1	ON CREW(RH CREW STA)	.1	250.6	22.0	43.4

NOTE: Further information relating to this table is given on pages 3.3-18, 3.3-19 and 3.3-20.

Table 3.3-9.2 (Continued)

MISSION H-2 TRANSFERRED CREW AND EQUIPMENT LIST								
ITEMS INITIALLY IN CM TRANSFERRED TO LM AT LM ACTIVATION THEN BACK TO CM PRIOR TO A/S JETTISON (6)								
LM COORDINATES								
DESCRIPTION	STOW. ITEM	REF	NO.	STOWAGE LOCATION	WEIGHT	X-C.G.	Y-C.G.	Z-C.G.
BIOINSTRUMENTATION ASSY-COR.	80203.	2	1	ON CREW(LH CREW STA)	1.1	250.6	-22.0	43.4
BIOINSTRUMENTATION ASSY-LMP.	80203.	2	1	ON CREW(RH CREW STA)	1.1	250.6	22.0	43.4
BIOBELT ASSEMBLY-COR.	80207.	2	1	ON CREW(LH CREW STA)	.2	250.6	-22.0	43.4
BIOBELT ASSEMBLY-LMP.	80207.	2	1	ON CREW(RH CREW STA)	.2	250.6	22.0	43.4
SCISSORS	80204.	2	1	ON CREW(LH CREW STA)	.5	250.6	-22.0	43.4
BAG,STOW.+XFR-16MM MAG.	06393.	4	1	TBD-2(ESTIMATED)	.2	250.0	3.0	43.5
PENLIGHTS-COR.	80206.	2	1	ON CREW(LH CREW STA)	.3	250.6	-22.0	43.4
PENLIGHTS-LMP.	80206.	2	1	ON CREW(RH CREW STA)	.3	250.6	22.0	43.4
DOSIMETER,PASSIVE-COR.	D0201.	1	3	ON CREW(LH CREW STA)	NEGL	250.6	-22.0	43.4
DOSIMETER,PASSIVE-LMP.	D0201.	1	3	ON CREW(RH CREW STA)	NEGL	250.6	22.0	43.4
DOSIMETER,PERSONAL-COR.	D0200.	2	1	ON CREW(LH CREW STA)	.4	250.6	-22.0	43.4
DOSIMETER,PERSONAL-LMP.	D0200.	2	1	ON CREW(RH CREW STA)	.4	250.6	22.0	43.4
GARMENT,LIQUID COOLED-COR.	80107.	1	1	ON CREW(LH CREW STA)	4.2	250.6	-22.0	43.4
GARMENT,LIQUID COOLED-LMP.	80107.	1	1	ON CREW(RH CREW STA)	4.2	250.6	22.0	43.4
FECAL CONTAINER SUBSYSTEM-COR.	80113.	1	1	ON CREW(LH CREW STA)	.3	250.6	-22.0	43.4
FECAL CONTAINER SUBSYSTEM-LMP.	80113.	1	1	ON CREW(RH CREW STA)	.3	250.6	22.0	43.4
CREW-COMMANDER	T80	10	1	LEFT CREW STATION	178.0	250.6	-22.0	43.4
CREW-LM PILOT	T80	10	1	RIGHT CREW STATION	170.0	250.6	22.0	43.4
LM LUNAR SURFACE CHECKLIST	A0114.10	1	1	DATA CARD KIT (FDF)	1.0	280.8	-20.0	14.0
LM SYS. ACTIVATION CHECKLIST	A0114.12	1	1	DATA CARD KIT (FDF)	.5	280.8	-20.0	14.0
LM LUNAR SURFACE MAPS	A0114.13	1	1	DATA CARD KIT (FDF)	1.0	280.8	-20.0	14.0
LM TIMELINE BOOK	A0114.14	1	1	DATA CARD KIT (FDF)	1.0	280.8	-20.0	14.0
LM XFR. DATA CARD KIT	A0114.18	1	1	LM FOF CONTR. (RHSSC)	1.0	280.8	-20.0	14.0
LM DATA CARD BOOK	A0114.19	1	1	DATA CARD KIT (FDF)	1.0	280.8	-20.0	14.0
CHART C,ORBITAL SCIENCE	A0114.22	1	1	DATA CARD KIT (FDF)	1.0	280.8	-20.0	14.0
CHART,LM ORBIT MONITOR	A0114.29	4	1	DATA CARD KIT (FDF)	1.0	280.8	-20.0	14.0
TOTAL LOCATION LM					469.70	250.82	.17	42.97

NOTE: Further information relating to this table is given on pages 3.3-18, 3.3-19 and 3.3-20

Table 3.3-9.2 (Continued)

MISSION H-2 TRANSFERRED CREW AND EQUIPMENT LIST								
ITEMS INITIALLY IN CM TRANSFERRED TO LM AT LM ACTIVATION THEN BACK TO CM PRIOR TO A/S JETTISON (7) APOLLO COORDINATES								
DESCRIPTION	STOW. ITEM	REF	NO.	STOWAGE LOCATION	WEIGHT	X-C.G.	Y-C.G.	Z-C.G.
BAG,MOTION SICKNESS-CDR.	A0208.	1	1	PGA CONTAINER	.1	1015.0	.0	-19.9
BAG,MOTION SICKNESS-LMP.	A0208.	1	1	PGA CONTAINER	.1	1015.0	.0	-19.9
U.C.T.A-CDR.	B0205.	4	1	ON CREW-CDR	.5	1043.0	.0	-6.0
U.C.T.A-LMP.	B0205.	4	1	ON CREW- LMP	.5	1043.0	24.5	-6.0
MAG.,16MM DATA ACQUISITION	A0101.1	12	1	AREA A8	1.0	1012.0	22.0	-23.0
TORSO AND LIMB SUIT,EV-CDR	B0200.1	4	1	PGA CONTAINER	39.2	1015.0	.0	-19.9
PRESSURE HELMET ASSEMBLY-CDR.	B0200.2	12	1	HELMET STOW BAG-CDR	2.4	1050.0	-27.0	39.0
GLOVES,IV,PAIR-CDR.	B0200.3	12	1	ACCESSORY BAG-CDR.	1.6	1050.0	-27.0	39.0
POCKETS,CHECKLIST+SCISSORS-CDR	B0200.5	1	2	ON ICG (ON CREW-CDR)	.2	1043.0	.0	-10.4
TORSO AND LIMB SUIT,EV-LMP.	B0200.1	4	1	PGA CONTAINER	39.2	1015.0	.0	-19.9
PRESSURE HELMET ASSEMBLY-LMP	B0200.2	12	1	HELMET STOW BAG-LMP	2.4	1039.0	47.0	12.0
GLOVES,IV,PAIR-LMP	B0200.3	12	1	ACCESSORY BAG-LMP.	1.6	1039.0	47.0	12.0
POCKETS,CHECKLIST+SCISSORS-LMP	B0200.5	1	2	ON ICG (ON CREW-LMP)	.2	1043.0	24.5	-10.4
MAG.,16MM DATA ACQUISITION	A0101.1	1	6	AREA R13	6.0	1024.0	45.0	-26.0
MAGAZINE,LUNAR SURF.HASSELBLAD	A0108.1	1	3	IN 70MM MAG BAG(R13)	4.2	1022.0	45.0	-24.0
DOSIMETER,PASSIVE RADIATION	D0101.	4	1	IN 16MM MAG.BAG(R13)	NEGL	1024.0	45.0	-26.0
BAG,STOW.+XFR-16MM MAG.	00380.	1	1	AREA R13	.2	1024.0	45.0	-26.0
BAG, 70MM MAGAZINE	00381.	1	1	AREA R13	.3	1024.0	45.0	-26.0
SUNGLASSES-CDR.	A0200.	2	1	ON CREW-CDR	.1	1043.0	.0	-10.4
SUNGLASSES-LMP.	A0200.	2	1	ON CREW- LMP	.1	1043.0	24.5	-10.4
POUCH,SUNGLASSES-CDR.	A0201.	2	1	ON CREW-CDR	NEGL	1043.0	.0	-10.4
POUCH,SUNGLASSES-LMP.	A0201.	2	1	ON CREW- LMP	NEGL	1043.0	24.5	-10.4
CHRONOGRAPH-CDR.	A0202.	2	1	ON CREW-CDR	.1	1043.0	.0	-10.4
CHRONOGRAPH-LMP.	A0202.	2	1	ON CREW- LMP	.1	1043.0	24.5	-10.4
WATCHBAND-CDR.	A0203.	2	1	ON CREW-CDR	NEGL	1043.0	.0	-10.4
WATCHBAND-LMP.	A0203.	2	1	ON CREW- LMP	NEGL	1043.0	24.5	-10.4
PENS,DATA RECORDING-CDR.	A0204.	2	1	ON CREW-CDR	.1	1043.0	.0	-10.4
PENS,DATA RECORDING-LMP.	A0204.	2	1	ON CREW- LMP	.1	1043.0	24.5	-10.4
PENS,MARKER-CDR.	A0205.	2	1	ON CREW-CDR	NEGL	1043.0	.0	-10.4
PENS,MARKER-LMP.	A0205.	2	1	ON CREW- LMP	NEGL	1043.0	24.5	-10.4
PENCIL-CDR.	A0206.	2	1	ON CREW-CDR	.1	1043.0	.0	-10.4
PENCIL-LMP.	A0206.	2	1	ON CREW- LMP	.1	1043.0	24.5	-10.4

NOTE: Further information relating to this table is given on pages 3.3-18, 3.3-19 and 3.3-20.

Table 3.3-9.2 (Continued)

MISSION H-2 TRANSFERRED CREW AND EQUIPMENT LIST								
ITEMS INITIALLY IN CM TRANSFERRED TO LM AT LM ACTIVATION THEN BACK TO CM PRIOR TO A/S JETTISON (7) APOLLO COORDINATES								
DESCRIPTION	STOW. ITEM	REF	NO.	STORAGE LOCATION	WEIGHT	X-C.G.	Y-C.G.	Z-C.G.
BIOINSTRUMENTATION ASSY-CDR.	B0203.	2	1	ON CREW-CDR	1.1	1041.0	.0	-13.0
BIOINSTRUMENTATION ASSY-LMP.	B0203.	2	1	ON CREW- LMP	1.1	1041.0	24.5	-13.0
BIOBELT ASSEMBLY-CDR.	B0207.	2	1	ON CREW-CDR	.2	1041.0	.0	-13.0
BIOBELT ASSEMBLY-LMP.	B0207.	2	1	ON CREW- LMP	.2	1041.0	24.5	-13.0
SCISSORS	B0204.	2	1	ON CREW-CDR	.5	1043.0	.0	-10.4
BAG,STOW.+XFR-16MM MAG.	O6393.	4	1	AREA A8	.2	1012.0	22.0	-23.0
PENLIGHTS-CDR.	B0206.	2	1	ON CREW-CDR	.3	1043.0	.0	-10.4
PENLIGHTS-LMP.	B0206.	2	1	ON CREW- LMP	.3	1043.0	24.5	-10.4
DOSIMETER,PASSIVE-CDR.	D0201.	1	3	ON PGA - CDR	NEGL	1043.0	.0	-11.9
DOSIMETER,PASSIVE-LMP.	D0201.	1	3	ON PGA - LMP	NEGL	1043.0	24.5	-11.9
DOSIMETER,PERSONAL-CDR.	D0200.	2	1	ON CREW-CDR	.4	1043.0	.0	-10.4
DOSIMETER,PERSONAL-LMP.	D0200.	2	1	ON CREW- LMP	.4	1043.0	24.5	-10.4
GARMENT,LIQUID COOLED-CDR.	B0107.	1	1	AREA U1	4.2	1033.0	23.0	-50.0
GARMENT,LIQUID COOLED-LMP.	B0107.	1	1	AREA U1	4.2	1033.0	23.0	-50.0
FECAL CONTAINER SUBSYSTEM-CDR.	B0113.	1	1	AREA U1	.3	1033.0	23.0	-50.0
FECAL CONTAINER SUBSYSTEM-LMP.	B0113.	1	1	AREA U1	.3	1033.0	23.0	-50.0
CREW-COMMANDER	T8D	10	1	CENTER COUCH	178.0	1043.0	.0	-10.4
CREW-LM PILOT	T8D	10	1	RIGHT COUCH	170.0	1043.0	24.5	-10.4
LM LUNAR SURFACE CHECKLIST	A0114.10	1	1	AREA R3	1.0	1072.0	26.0	9.0
LM SYS. ACTIVATION CHECKLIST	A0114.12	1	1	AREA R3	.5	1072.0	26.0	9.0
LM LUNAR SURFACE MAPS	A0114.13	1	1	AREA R3	1.0	1072.0	26.0	9.0
LM TIMELINE BOOK	A0114.14	1	1	AREA R3	1.0	1072.0	26.0	9.0
LM XFR. DATA CARD KIT	A0114.18	1	1	AREA R3	1.0	1072.0	26.0	9.0
LM DATA CARD BOOK	A0114.19	1	1	AREA R3	1.0	1072.0	26.0	9.0
CHART C,ORBITAL SCIENCE	A0114.22	1	1	AREA R3	1.0	1072.0	26.0	9.0
CHART,LM ORBIT MONITOR	A0114.29	4	1	AREA R3	1.0	1072.0	26.0	9.0
TOTAL FINAL LOCATION CM					469.70	1038.07	11.14	-12.20

NOTE: Further information relating to this table is given on pages 3.3-18, 3.3-19 and 3.3-20

Table 3.3-9.2 (Continued)

MISSION H-2 TRANSFERRED CREW AND EQUIPMENT LIST								
ITEMS INITIALLY IN LM REARRANGED IN LM PRIOR TO LM ACTIVATION (8)								
LM COORDINATES								
DESCRIPTION	STOW. ITEM	REF	NO.	STOWAGE LOCATION	WEIGHT	X-C.G.	Y-C.G.	Z-C.G.
CHECKLIST,EVA CUFF-CDR.	A1040.	4	1	ON EV GLOVE IN HSB	.3	221.0	-22.0	51.0
CHECKLIST,EVA CUFF-LMP.	A1040.	4	1	ON EV GLOVE IN HSB	.3	221.0	22.0	51.0
GLOVES,EV,PAIR-CDR.	81015.	2	1	HSB-CDR.(ON FLOOR)	2.2	221.0	-22.0	51.0
GLOVES,EV,PAIR-LMP.	81015.	2	1	HSB-LMP.(ON FLOOR)	2.2	221.0	22.0	51.0
VISOR,LUNAR EXTRAVEHICULAR-CDR	81014.	2	1	HSB-CDR.(ON FLOOR)	4.1	221.0	-22.0	51.0
VISOR,LUNAR EXTRAVEHICULAR-LMP	81014.	2	1	HSB-LMP.(ON FLOOR)	4.1	221.0	22.0	51.0
INTERIM STOWAGE ASSY	03007.	1	1	FRONT/CTR INST PANEL	4.0	284.0	.0	52.8
KIT,EMU MAINTENANCE	81016.	2	1	HSB-(ON CABIN FLOOR)	.5	221.0	-28.0	51.0
ELECTRICAL ASSY.(ACA PLUG)	03019.	12	1	ISA(FRONT OF CTR.PNL)	.1	284.0	.0	52.8
UTILITY LIGHTS WITH CORD-L.H.	03006.	3	1	ISA(FRONT OF CTR.PNL)	1.4	284.0	.0	52.8
UTILITY LIGHTS WITH CORD-R.H.	03006.	3	1	ISA(FRONT OF CTR.PNL)	1.4	284.0	.0	52.8
BAG,TEMPORARY STOWAGE	03031.	1	1	ISA(FRONT OF CTR.PNL)	.7	284.0	.0	52.8
BAG,XFR.-16MM L.S.CAMERA SYST.	03053.	12	1	RH SIDE STOW.COMPT.	.5	238.4	38.6	46.0
BUNGEE CORD	A1032.	1	1	ISA(FRONT OF CTR.PNL)	.1	284.0	.0	52.8
CAP,DUST	03020.	1	1	ISA(FRONT OF CTR.PNL)	NEGL	284.0	.0	52.8
CAP,DUST	G3021.	1	1	ISA(FRONT OF CTR.PNL)	NEGL	284.0	.0	52.8
SCALE, SAMPLE	G4031.	1	1	FRONT/CTR INST PANEL	.8	284.0	.0	52.8
BAG,DRINKING (IN SUIT)	81048.	1	2	ISA(FRONT OF CTR.PNL)	.4	284.0	.0	52.8
BAG,HELMET STOWAGE-CDR.	81013.	3	1	ON CABIN FLOOR	1.4	221.0	-22.0	51.0
BAG,HELMET STOWAGE-LMP.	81013.	3	1	ON CABIN FLOOR	1.4	221.0	22.0	51.0
TOTAL INITIAL LOCATION LM					25.90	242.98	.20	51.52

NOTE: Further information relating to this table is given on pages 3.3-18, 3.3-19 and 3.3-20

Table 3.3-9.2 (Continued)

MISSION H-2 TRANSFERRED CREW AND EQUIPMENT LIST								
ITEMS INITIALLY IN LM REARRANGED IN LM PRIOR TO LM ACTIVATION (9)								
LM COORDINATES								
DESCRIPTION	STOW. ITEM	REF	NO.	STOWAGE LOCATION	WEIGHT	X-C.G.	Y-C.G.	Z-C.G.
CHECKLIST,EVA CUFF-CDR.	A1040.	4	1	ON EV GLOVE IN HSB	.3	260.0	-5.5	-1.5
CHECKLIST,EVA CUFF-LMP.	A1040.	4	1	ON EV GLOVE IN HSB	.3	260.0	5.5	6.0
GLOVES,EV,PAIR-CDR.	B1015.	2	1	HSB (ASC.ENG.COVER)	2.2	260.0	-5.5	-1.5
GLOVES,EV,PAIR-LMP.	B1015.	2	1	HSB (ASC.ENG.COVER)	2.2	260.0	5.5	6.0
VISOR,LUNAR EXTRAVEHICULAR-CDR	B1014.	2	1	HSB (ASC.ENG.COVER)	4.1	260.0	-5.5	-1.5
VISOR,LUNAR EXTRAVEHICULAR-LMP	B1014.	2	1	HSB (ASC.ENG.COVER)	4.1	260.0	5.5	6.0
INTERIM STOWAGE ASSY	O3007.	1	1	LH MID-SECTION SHELF	4.0	270.3	-15.0	19.0
KIT,EMU MAINTENANCE	B1016.	2	1	HSB (ASC.ENG.COVER)	.5	260.0	-5.5	-1.5
ELECTRICAL ASSY.(ACA PLUG)	O3019.	12	1	ISA(LH MID-SEC.SHLF)	.1	270.3	-15.0	19.0
UTILITY LIGHTS WITH CORD-L.H.	O3006.	3	1	LEFT CREW STATION	1.4	252.0	-22.0	43.4
UTILITY LIGHTS WITH CORD-R.H.	O3006.	3	1	RIGHT CREW STATION	1.4	252.0	22.0	43.4
BAG,TEMPORARY STOWAGE	O3031.	1	1	ISA(LH MID-SEC.SHLF)	.7	270.3	-15.0	19.0
BAG,XFR.-16MM L.S.CAMERA SYST.	O3053.	12	1	TBD-6 (ESTIMATED)	.5	256.0	1.2	34.3
BUNGEE CORD	A1032.	1	1	ISA(LH MID-SEC.SHLF)	.1	270.3	-15.0	19.0
CAP,DUST	O3020.	1	1	ISA(LH MID-SEC.SHLF)	NEGL	270.3	-15.0	19.0
CAP,DUST	O3021.	1	1	ISA(LH MID-SEC.SHLF)	NEGL	270.3	-15.0	19.0
SCALE, SAMPLE	G4031.	1	1	ISA(LH MID-SEC.SHLF)	.8	270.3	-15.0	19.0
BAG,DRINKING (IN SUIT)	B1048.	1	2	ISA(LH MID-SEC.SHLF)	.4	270.3	-15.0	19.0
BAG,HELMET STOWAGE-CDR.	B1013.	3	1	ASC ENGINE COVER	1.4	260.0	-5.5	-1.5
BAG,HELMET STOWAGE-LMP.	B1013.	3	1	ASC ENGINE COVER	1.4	260.0	5.5	6.0
TOTAL RELOCATED IN LM					25.90	261.48	-3.62	11.19

NOTE: Further information relating to this table is given on pages 3.3-18, 3.3-19 and 3.3-20

Table 3.3-9.2 (Continued)

MISSION H-2 TRANSFERRED CREW AND EQUIPMENT LIST								
ITEMS REARRANGED IN LM PRIOR TO PCI (30)								
LM COORDINATES								
DESCRIPTION	STOW. ITEM	REF	NO.	STOWAGE LOCATION	WEIGHT	X-C.G.	Y-C.G.	Z-C.G.
REMOTE CONTRL UNIT, PLSS	B1001.	5	2	ON MINUS 227 BLKHD	9.0	272.0	.0	-18.0
OXYGEN PURGE SYSTEM	B1012.	12	1	IN SRC RACK NO.1-LWR	40.4	257.4	-20.7	-6.0
OXYGEN PURGE SYSTEM	B1012.	12	1	IN SRC RACK NO.2-UPR	40.4	265.9	-20.7	-6.0
PURGE VALVE ASSEMBLY	B1017.	1	1	LUNAR OVERSHOES(LHMS	.5	277.3	-20.0	-9.5
PURGE VALVE ASSEMBLY	B1017.	1	1	LUNAR DVERSHOES(LHMS	.5	277.3	-20.0	-9.5
TOTAL INITIAL LOCATION LM					90.80	262.85	-18.64	-7.23
MISSION H-2 TRANSFERRED CREW AND EQUIPMENT LIST								
ITEMS REARRANGED IN LM PRIOR TO PDI (31)								
LM COORDINATES								
DESCRIPTION	STOW. ITEM	REF	NO.	STOWAGE LOCATION	WEIGHT	X-C.G.	Y-C.G.	Z-C.G.
REMOTE CONTROL UNIT, PLSS	B1001.	5	2	ON FLOOR (HATCHWAY)	9.0	219.7	.0	44.7
OXYGEN PURGE SYSTEM	B1012.	12	1	ON FLOOR (HATCHWAY)	40.4	219.7	.0	44.7
OXYGEN PURGE SYSTEM	B1012.	12	1	ON FLOOR (HATCHWAY)	40.4	219.7	.0	44.7
PURGE VALVE ASSEMBLY	B1017.	1	1	TEMP.ST.8G(ISA/LHMS)	.5	270.3	-15.0	19.0
PURGE VALVE ASSEMBLY	B1017.	1	1	TEMP.ST.9G(ISA/LHMS)	.5	270.3	-15.0	19.0
TOTAL RELOCATED IN LM					90.80	220.26	-.17	44.42

NOTE: Further information relating to this table is given on pages 3.3-18, 3.3-19 and 3.3-20

Table 3.3-9.2 (Continued)

MISSION H-2 TRANSFERRED CREW AND EQUIPMENT LIST								
ITEMS OFFLOADED FROM A/S TO LUNAR SURFACE PRIOR TO LUNAR LIFTOFF (10)								
LM COORDINATES								
DESCRIPTION	STGW. ITEM	REF	NO.	STOWAGE LOCATION	WEIGHT	X-C.G.	Y-C.G.	Z-C.G.
ARM RESTS	TBC	8	4	CREW STA.-CDR/LMP.	4.4	260.0	.0	45.0
CHECKLIST,EVA CUFF-CDR.	A1040.	4	1	ON EV GLOVE IN HSB	.3	260.0	-5.5	-1.5
CHECKLIST,EVA CUFF-LMP.	A1040.	4	1	ON EV GLOVE IN HSB	.3	260.0	5.5	6.0
CLSRC (WITHOUT SAMPLES)	G4016.	3	1	LH SIDE STOW COMPT.	.7	235.0	-34.0	45.0
TRIGGER, CAMERA	A1027.	2	2	RH SIDE STOW.COMPT.	.4	238.4	38.6	46.0
HANDLE, CAMERA	A1029.	2	2	RH SIDE STOW.COMPT.	1.0	238.4	38.6	46.0
FILTER, POLARIZING	A1005.	1	1	ON 60MM LENS(RHSSC)	.2	238.4	38.6	46.0
CAMERA,LUNAR SUPP.HASSELBLAD	A1015.	1	2	RH SIDE STOW.COMPT.	5.4	238.4	38.6	46.0
LENS, 60MM	A1016.	1	2	ON CAMERA (RHSSC)	3.6	238.4	38.6	46.0
BAG,XFR.-16MM L.S.CAMERA SYST.	OJ053.	12	1	TBC-6(ESTIMATED)	.5	256.0	1.2	34.3
ADAPTER BRACKET,RIGHT ANGLE	A1021.	12	1	LH SIDE STOW COMPT.	.2	235.0	-34.0	45.0
PROTECTIVE COVEP,RESEAU	A1023.	2	2	ON CAMERA (RHSSC)	.4	238.4	38.6	46.0
DEFECATION COLLECTION DEVICE	B1009.	2	4	RH SIDE STOW.COMPT.	.8	238.4	38.6	46.0
REMOTE CONTROL UNIT,PLSS	B1001.	5	2	ON FLOOR (HATCHWAY)	9.0	219.7	.0	44.7
LUNAR OVERSHOES-PAIP	B1019.	1	2	LH MID-SECTION SHELF	9.0	279.6	-20.5	8.5
EARPLUGS-CDR.	B0210.	1	2	ON PGA-CDR (ON CREW)	NEGL	250.6	-22.0	43.4
EARPLUGS-LMP.	B0210.	1	2	ON PGA-LMP (CN CREW)	NEGL	250.6	22.0	43.4
PLSS/EVCS ASSEMBLY	B1024.	1	1	RECHARGE STATION	79.7	262.8	-20.8	15.4
PLSS/EVCS ASSEMBLY	B1025.	1	1	ON FLOOR (HATCHWAY)	79.4	219.7	.0	44.7
BRACKET,CAMERA MOUNT	B1001.1	3	2	LH MID-SECTION SHELF	1.2	270.3	-15.0	19.0
ADAPTER, SRC/OPS	O3004.	3	1	ON OPS(SRC RK.NO.1)	2.2	257.4	-20.7	-6.0
CANNISTER, ECS LICH	O3008.	3	1	AFT OF ASC.ENG.COVER	9.2	250.0	8.8	-11.8
STRAP, ECS LICH CANNISTER	O3024.	1	1	ON LICH CRT(ENG.CVR)	.1	250.0	8.8	-11.8
URINE COLLECTION ASSY.,SMALL	O3009.	10	6	RH SIDE STOW.COMPT.	1.8	238.4	38.6	46.0
BAG,CAMERA MOUNT BRACKET	O3034.	2	1	ISA(LH MID-SEC.SHLF)	.3	270.3	-15.0	19.0
BAG, EMESIS	O3011.	1	4	RH SIDE STOW.COMPT.	.8	238.4	38.6	46.0
CONTAINER ASSEMBLY,DISPOSAL	O3012.	1	1	LH SIDE STOW COMPT.	2.8	235.0	-34.0	45.0
ADAPTER, SRC/OPS	O3004.	3	1	ON OPS(SRC RK.NO.2)	2.2	265.9	-20.7	-6.0
CONTAINER ASSEMBLY,DISPOSAL	O3012.1	1	1	LH SIDE STOW COMPT.	2.4	235.0	-34.0	45.0
SCALE, SAMPLE	G4031.	1	1	ISA(LH MID-SEC.SHLF)	.8	270.3	-15.0	19.0
BAG,DRINKING (IN SUIT)	B1049.	1	2	ISA(LH MID-SEC.SHLF)	.4	270.3	-15.0	19.0
TOWELS, UTILITY (RED)	B1043.	1	2	HAMMOCK(UNDER LHSSC)	.2	226.1	-34.3	41.9

NOTE: Further information relating to this table is given on pages 3.3-18, 3.3-19 and 3.3-20.

Table 3.3-9.2 (Continued)

MISSION H-2 TRANSFERRED CREW AND EQUIPMENT LIST								
ITEMS DELOADED FROM A/S TO LUNAR SURFACE PRIOR TO LUNAR LIFTOFF (10)								
LM COORDINATES								
DESCRIPTION	STOW. ITEM	PEF	NO.	STORAGE LOCATION	WEIGHT	X-C.G.	Y-C.G.	Z-C.G.
TOWELS, UTILITY (BLUE)	R1044.	1	2	HAMMOCK (UNDER LHSSCI)	.2	226.1	-34.3	41.9
HAMMOCK ASSEMBLY-LMP.	R3050.	1	1	UNDER LHSSC	4.1	226.1	-34.3	41.9
CABLE, REMOTE CONTROL, 16MM CAM.	A1022.	1	1	LH SIDE STOW COMPT.	.7	235.0	-34.0	45.0
LM FOOD ASSY (2-2/3 MAN DAYS)	C1000.	1	1	LM MID-SECTION SHELF	7.0	279.6	-20.5	8.5
CONTAINER, PLSS CONDENSATE	O3014.	9	1	LH MID-SECTION SHELF	4.8	279.6	-20.5	8.5
HAMMOCK ASSY-CDR.	O3049.	1	1	UNDER LHSSC	4.1	226.1	-34.3	41.9
BAG ASSY, LEC + W.T.	R1020.1	1	1	LHMS (BELOW PLSS)	.2	236.0	-16.5	16.2
CONVEYOR ASSY., LUNAR EQUIPMENT	B1020.2	1	1	BAG ASSY, LEC+WT (LHMS)	1.4	236.0	-16.5	16.2
BAG, LUNAR EQUIPMENT CONVEYOR	B1020.3	1	1	BAG ASSY, LEC+WT (LHMS)	.1	236.0	-16.5	16.2
LM SYS. ACTIVATION CHECKLIST	A0114.12	1	1	DATA CARD KIT (FDF)	.5	290.8	-20.0	14.0
BAG, JETTISON STOWAGE	R1027.	1	3	LH SIDE STOW COMPT.	2.7	235.0	-34.0	45.0
POWER PACK, 16MM RAT. OPERAT. CAM	A0155.4	12	1	TRD-6 (ESTIMATED)	3.3	256.0	1.2	34.3
CAMERA, 16MM BATTERY OPERATED	A0155.1	12	1	TRD-6 (ESTIMATED)	3.0	256.0	1.2	34.3
LENS 10MM, 16MM RAT. OPERAT. CAM.	A0155.2	12	1	TBC-6 (ESTIMATED)	.5	256.0	1.2	34.3
HANDLE, 16MM RAT. OPERATED CAM.	A0155.3	12	1	TRD-6 (ESTIMATED)	.8	256.0	1.2	34.3
BRKT, ACU, 16MM RAT. OPERAT. CAM.	A0155.5	12	1	TRD-6 (ESTIMATED)	.3	256.0	1.2	34.3
COLLECT. BAG, CAL. PLSS FEEDWATER	R1026.	1	1	RH SIDE STOW. COMPT.	.8	238.4	38.6	46.0
COLL. BAG, CAL. PLSS H2O W/O SCAL	R1026.1	1	1	RH SIDE STOW. COMPT.	.5	238.4	38.6	46.0
STRAP, INTERIM STOWAGE	A1013.	1	2	BAG ASSY, LEC+WT (LHMS)	NEGL	236.0	-16.5	16.2
TV SUBSYSTEM, LUNAR	E1000.	1	1	MINUS 2 27 BULKHEAD	8.0	272.0	.0	-18.0
TOTAL LOCATION LM					262.79	245.43	-8.27	27.25

NOTE: Further information relating to this table is given on pages 3.3-18, 3.3-19 and 3.3-20

Table 3.3-9.2 (Continued)

MISSION H-2 TRANSFERRED CREW AND EQUIPMENT LIST								
ITEMS REARRANGED IN A/S PRIOR TO LUNAR LIFTOFF (11)								
						LM COORDINATES		
DESCRIPTION	STOW. ITEM	REF	NO.	STORAGE LOCATION	WEIGHT	X-C.G.	Y-C.G.	Z-C.G.
MAG., 16MM DATA ACQUISITION	A0101.1	12	1	TBD-2 (ESTIMATED)	1.0	250.0	3.0	43.5
MAGAZINE, LUNAR SURF. HASSELBLAD	A0108.1	1	2	ISA (LH MID-SEC. SHLF)	2.8	270.3	-15.0	19.0
BAG, 70MM MAG. (LM XFR)	06367	1	1	ISA (LH MID-SEC. SHLF)	.2	270.3	-15.0	19.0
ATTACHMENT STRAP, OPS/PGA	B1021.	3	2	DN PLSS (RECHARG STA)	.4	262.8	-20.8	15.4
ATTACHMENT STRAP, OPS/PGA	B1022.	3	2	DN PLSS (CABIN FLOOR)	.6	219.7	.0	44.7
PURGE VALVE ASSEMBLY	B1017.	1	1	TEMP. ST. BG (ISA/LHMS)	.5	270.3	-15.0	19.0
PURGE VALVE ASSEMBLY	B1017.	1	1	TEMP. ST. BG (ISA/LHMS)	.5	270.3	-15.0	19.0
LIFE LINE, LIGHT WEIGHT	B1020.4	1	1	BAG ASSY, LEC+WT (LHMS)	.5	236.0	-16.5	16.2
DEPLOYMENT BAG, LIFE LINE	B1020.5	1	1	BAG ASSY, LEC+WT (LHMS)	.1	236.0	-16.5	16.2
TETHER, EVA WAIST	B1020.6	1	1	BAG ASSY, LEC+WT (LHMS)	.6	236.0	-16.5	16.2
TETHER, EVA WAIST	B1020.7	1	1	BAG ASSY, LEC+WT (LHMS)	.6	236.0	-16.5	16.2
TOTAL INITIAL LOCATION LM					7.80	255.51	-12.18	23.29
MISSION H-2 TRANSFERRED CREW AND EQUIPMENT LIST								
ITEMS REARRANGED IN A/S PRIOR TO LUNAR LIFTOFF (12)								
						LM COORDINATES		
DESCRIPTION	STOW. ITEM	REF	NO.	STORAGE LOCATION	WEIGHT	X-C.G.	Y-C.G.	Z-C.G.
MAG., 16MM DATA ACQUISITION	A0101.1	12	1	TBD-5 (ESTIMATED)	1.0	252.5	16.0	30.0
MAGAZINE, LUNAR SURF. HASSELBLAD	A0108.1	1	2	70MM MAG. BAG (RHSSC)	2.8	238.4	38.6	46.0
BAG, 70MM MAG. (LM XFR)	06367	1	1	RH SIDE STOW. COMPT.	.2	238.4	38.6	46.0
ATTACHMENT STRAP, OPS/PGA	B1021.	3	2	RH SIDE STOW. COMPT.	.4	238.4	38.6	46.0
ATTACHMENT STRAP, OPS/PGA	B1022.	3	2	RH SIDE STOW. COMPT.	.6	238.4	38.6	46.0
PURGE VALVE ASSEMBLY	B1017.	1	1	HSB (ASC. ENG. COVER)	.5	260.0	-5.5	-1.5
PURGE VALVE ASSEMBLY	B1017.	1	1	HSB (ASC. ENG. COVER)	.5	260.0	5.5	6.0
LIFE LINE, LIGHT WEIGHT	B1020.4	1	1	LH MID-SECTION SHELF	.5	279.6	-20.5	8.5
DEPLOYMENT BAG, LIFE LINE	B1020.5	1	1	LH MID-SECTION SHELF	.1	279.6	-20.5	8.5
TETHER, EVA WAIST	B1020.6	1	1	LH MID-SECTION SHELF	.6	279.6	-20.5	8.5
TETHER, EVA WAIST	B1020.7	1	1	LH MID-SECTION SHELF	.6	279.6	-20.5	8.5
TOTAL RELOCATED LM					7.80	252.48	17.12	29.69

NOTE: Further information relating to this table is given on pages 3.3-18, 3.3-19 and 3.3-20

3/30/70

Table 3.3-9.2 (Continued)

MISSION H-2 TRANSFERRED CREW AND EQUIPMENT LIST								
ITEMS LOADED ONTO A/S PRIOR TO LUNAR LIFTOFF THEN TRANSFERRED TO CM PRIOR TO A/S JETTISON (13)								
LM COORDINATES								
DESCRIPTION	STOW. ITEM	REF	NO.	STOWAGE LOCATION	WEIGHT	X-C.G.	Y-C.G.	Z-C.G.
CLSRC AND SAMPLES	G4016.	12	1	LH MID-SECTION SHELF	2.6	279.6	-20.5	8.5
SRC NO.1 (LOADED)	G4003.	2	1	IN SRC RACK NO.1-LWR	65.0	257.4	-20.7	-6.0
SRC NO.2 (LOADED)	G4004.	2	1	IN SRC RACK NO.2-UPR	65.0	265.9	-20.7	-6.0
CASSETTE, CSC	J4001.	10	1	ISA (LH MID-SEC.SHLF)	.4	270.3	-15.0	19.0
WEIGH BAG(WT.INCL.IN TOTE BAG)	G4018.	1	1	ISA (MODIFIED)	NEGL	280.0	.0	-10.0
WEIGH BAG(WT.INCL.IN TOTE BAG)	G4018.	1	1	ISA (MODIFIED)	NEGL	280.0	.0	-10.0
SOLAR WIND EXP.(INCL.IN SRC 2)	G4011.	1	1	SRC NO.2(RACK NO.2)	NEGL	257.4	-20.7	-6.0
TOTE BAG,APOLLO L.S. (LOADED)	03051.	9	1	ISA (MODIFIED)	35.0	280.0	.0	-10.0
TOTE BAG,APOLLO L.S.(LOADED)	03051.	9	1	ISA (MODIFIED)	35.0	280.0	.0	-10.0
TOTAL INITIAL LOCATION LM					203.00	268.22	-13.55	-7.14
MISSION H-2 TRANSFERRED CREW AND EQUIPMENT LIST								
ITEMS LOADED ONTO A/S PRIOR TO LUNAR LIFTOFF THEN TRANSFERRED TO CM PRIOR TO A/S JETTISON (14)								
APOLLO COORDINATES								
DESCRIPTION	STOW. ITEM	REF	NO.	STOWAGE LOCATION	WEIGHT	X-C.G.	Y-C.G.	Z-C.G.
CLSRC AND SAMPLES	G4016.	12	1	AREA A5	2.6	1015.0	9.0	28.0
SRC NO.1 (LOADED)	G4003.	2	1	AREA B5	65.0	1031.0	-8.0	39.0
SRC NO.2 (LOADED)	G4004.	2	1	AREA B6	65.0	1031.0	13.0	39.0
CASSETTE, CSC	J4001.	10	1	TEMP. STOW. BAG-LMP	.4	1036.5	40.0	-25.0
WEIGH BAG(WT.INCL.IN TOTE BAG)	G4018.	1	1	IN DECONT.BAG(ON A1)	NEGL	1012.0	-22.0	-26.0
WEIGH BAG(WT.INCL.IN TOTE BAG)	G4018.	1	1	ON A7 + A11	NEGL	1011.5	25.0	7.0
SOLAR WIND EXP.(INCL.IN SRC 2)	G4011.	1	1	IN SRC NO.2 (86)	NEGL	1031.0	13.0	39.0
TOTE BAG,APOLLO L.S. (LOADED)	03051.	9	1	IN DECONT.BAG(ON A1)	35.0	1012.0	-22.0	-26.0
TOTE BAG,APOLLO L.S.(LOADED)	03051.	9	1	ON A7 + A11	35.0	1011.5	25.0	7.0
TOTAL LOCATION CM					203.00	1024.17	2.31	22.01

NOTE: Further information relating to this table is given on pages 3.3-18, 3.3-19 and 3.3-20.

Table 3.3-9.1 (Continued)

MISSION H-2 TRANSFERRED CREW AND EQUIPMENT LIST								
ITEMS INITIALLY IN LM TRANSFERRED TO CM PRIOR TO A/S JETTISON (15)								
LM COORDINATES								
DESCRIPTION	STOW. ITEM	REF	NO.	STOWAGE LOCATION	WEIGHT	X-C.G.	Y-C.G.	Z-C.G.
MAG., 16MM DATA ACQUISITION	A0101.1	12	1	TBC-5 (ESTIMATED)	1.0	252.5	16.0	30.0
COMMUNICATION CARRIER-CDR.	80200.4	12	1	ON CREW (LM CREW STA)	1.6	250.6	-22.0	43.4
COMMUNICATION CARRIER-LMP.	80200.4	12	1	ON CREW (RH CREW STA)	1.6	250.6	22.0	43.4
MAGAZINE, LUNAR SURF. HASSELBLAD	A0108.1	1	2	70MM MAG. BAG (RHSSC)	2.8	238.4	38.6	46.0
BAG, 70MM MAG. (LM XFR)	06367	1	1	RH SIDE STOW. COMPT.	.2	238.4	38.6	46.0
D.S.E.A.	03005.	10	1	ON PLUS Z27 BULKHEAD	2.3	260.0	-37.0	28.0
KIT, PILOT PREFERENCE	A1007.	1	3	RH SIDE STOW. COMPT.	1.5	238.4	38.6	46.0
ISA (MODIFIED)	T8D	9	1	TRO-4 (FOR ISA)	6.8	280.0	.0	-10.0
TOTAL INITIAL LOCATION LM					17.80	260.07	5.88	20.91
MISSION H-2 TRANSFERRED CREW AND EQUIPMENT LIST								
ITEMS INITIALLY IN LM TRANSFERRED TO CM PRIOR TO A/S JETTISON (16)								
APOLLO COORDINATES								
DESCRIPTION	STOW. ITEM	REF	NO.	STOWAGE LOCATION	WEIGHT	X-C.G.	Y-C.G.	Z-C.G.
MAG., 16MM DATA ACQUISITION	A0101.1	12	1	AREA AB	1.0	1012.0	22.0	-23.0
COMMUNICATION CARRIER-CDR.	80200.4	12	1	ON CREW-CDR	1.6	1043.0	.0	-10.4
COMMUNICATION CARRIER-LMP.	80200.4	12	1	ON CREW- LMP	1.6	1043.0	24.5	-10.4
MAGAZINE, LUNAR SURF. HASSELBLAD	A0108.1	1	2	IN 70MM MAG BAG (R13)	2.8	1022.0	45.0	-24.0
BAG, 70MM MAG. (LM XFR)	06367	1	1	AREA R13	.2	1024.0	45.0	-26.0
D.S.E.A.	03005.	10	1	AREA R13	2.3	1024.0	45.0	-26.0
KIT, PILOT PREFERENCE	A1007.	1	3	AREA R13	1.5	1024.0	45.0	-26.0
ISA (MODIFIED)	T8D	9	1	IN DECONT. BAG (ON A1)	6.8	1012.0	-22.0	-26.0
TOTAL LOCATION CM					17.80	1021.84	12.22	-22.71

NOTE: Further information relating to this table is given on pages 3.3-18, 3.3-19 and 3.3-20

Table 3.3-9.2 (Continued)

MISSION H-2 TRANSFERRED CREW AND EQUIPMENT STOWAGE LIST ITEMS INITIALLY IN L4 TRANSFERRED TO CM AT LM ACTIVATION THEN BACK TO LM PRIOR TO A/S JETTISON LM COORDINATES								
DESCRIPTION	STOW. ITEM	REF	NO.	STOWAGE LOCATION	WEIGHT	X-C.G.	Y-C.G.	Z-C.G.
CSM/LM UMBILICAL	TBD	10	1	IN LM TUNNEL	1.1	300.0	.0	.0
TOTAL INITIAL LOCATION LM					1.10	300.00	.00	.00
MISSION H-2 TRANSFERRED CREW AND EQUIPMENT STOWAGE LIST ITEMS INITIALLY IN L4 TRANSFERRED TO CM AT LM ACTIVATION THEN BACK TO LM PRIOR TO A/S JETTISON APOLLO COORDINATES								
DESCRIPTION	STOW. ITEM	REF	NO.	STOWAGE LOCATION	WEIGHT	X-C.G.	Y-C.G.	Z-C.G.
CSM/LM UMBILICAL	TBD	10	1	UNDER RH COUCH	1.1	1025.0	24.5	-10.0
TOTAL LOCATION CM					1.10	1025.00	24.50	-10.00
MISSION H-2 TRANSFERRED CREW AND EQUIPMENT STOWAGE LIST ITEMS INITIALLY IN LM TRANSFERRED TO CM AT LM ACTIVATION THEN BACK TO LM PRIOR TO A/S JETTISON LM COORDINATES								
DESCRIPTION	STOW. ITEM	REF	NO.	STOWAGE LOCATION	WEIGHT	X-C.G.	Y-C.G.	Z-C.G.
CSM/LM UMBILICAL	TBD	10	1	IN LM TUNNEL	1.1	300.0	.0	.0
TOTAL FINAL LOCATION LM					1.10	300.00	.00	.00

Table 3.3-9.2 (Continued)

MISSION H-2 TRANSFERRED CREW AND EQUIPMENT LIST								
ITEMS INITIALLY IN CM TRANSFERRED TO A/S PRIOR TO A/S JETTISON (20)								
APOLLO COORDINATES								
DESCRIPTION	STOW. ITEM	REF	NO.	STOWAGE LOCATION	WEIGHT	X-C.G.	Y-C.G.	Z-C.G.
DOCKING MECHANISM AND PROBE	00349.	10	1	IN CM TUNNEL	193.5	1110.3	.0	.0
CO2 ABSORBERS (USED)	00327.	11	4	AREA B5	26.8	1031.0	-8.0	39.0
CO2 ABSORBERS (USED)	00327.	11	4	AREA B6	26.8	1031.0	13.0	39.0
SHIMS, CO2 ABSORBERS	00328.	1	4	AREA B5	.8	1031.0	-8.0	39.0
SHIMS, CO2 ABSORBERS	00328.	1	4	AREA B6	.8	1031.0	13.0	39.0
CONTAINER B5	00342.	1	1	AREA B5	14.2	1031.0	-8.0	39.0
CONTAINER B6	00343.	1	1	AREA B6	14.5	1031.0	13.0	39.0
BRUSH, VACUUM	80139.	1	1	AREA A8	.4	1012.0	22.0	-23.0
HOSE, VACUUM	06332.	1	1	AREA A8	2.3	1012.0	22.0	-23.0
COUPL.ASY,PGA O2 UMB.INTERCON.	00351.	1	1	AREA A8	.4	1012.0	22.0	-23.0
BAG, JETTISON STOWAGE	80147.	13	1	AREA R13	.9	1024.0	45.0	-26.0
TOTAL INITIAL LOCATION CM					281.40	1085.30	1.14	11.29
MISSION H-2 TRANSFERRED CREW AND EQUIPMENT LIST								
ITEMS INITIALLY IN CM TRANSFERRED TO A/S PRIOR TO A/S JETTISON (21)								
LM COORDINATES								
DESCRIPTION	STOW. ITEM	REF	NO.	STOWAGE LOCATION	WEIGHT	X-C.G.	Y-C.G.	Z-C.G.
CO2 ABSORBERS (USED)	00327.	11	4	IN SRC RACK NO.1-LWR	26.8	257.4	-20.7	-6.0
CO2 ABSORBERS (USED)	00327.	11	4	IN SRC RACK NO.2-UPR	26.8	265.9	-20.7	-6.0
SHIMS, CO2 ABSORBERS	00328.	1	4	IN SRC RACK NO.1-LWR	.8	257.4	-20.7	-6.0
SHIMS, CO2 ABSORBERS	00328.	1	4	IN SRC RACK NO.2-UPR	.8	265.9	-20.7	-6.0
CONTAINER B5	00342.	1	1	IN SRC RACK NO.1-LWR	14.2	257.4	-20.7	-6.0
CONTAINER B6	00343.	1	1	IN SRC RACK NO.2-UPR	14.5	265.9	-20.7	-6.0
BRUSH, VACUUM	80139.	1	1	LM FWD.HATCH CONTNR.	.4	233.0	-3.0	63.0
HOSE, VACUUM	06332.	1	1	LM FWD.HATCH CONTNR.	2.3	233.0	-3.0	63.0
DOCKING PROBE	00349.	10	1	ON CABIN FLOOR	81.8	226.0	-20.4	41.8
DOCKING STRUCTURE	T80	10	1	IN LM TUNNEL	111.7	314.7	.0	.0
COUPL.ASY,PGA O2 UMB.INTERCON.	00351.	1	1	LM FWD.HATCH CONTNR.	.4	233.0	-3.0	63.0
BAG, JETTISON STOWAGE	80147.	13	1	ON CABIN FLOOR	.9	226.0	-20.4	41.8
TOTAL LOCATION LM					281.40	271.92	-12.20	11.19

NOTE: Further information relating to this table is given on pages 3.3-18, 3.3-19 and 3.3-20

Table 3.3-9.2 (Continued)

MISSION H-2 TRANSFERRED CREW AND EQUIPMENT LIST								
ITEMS INITIALLY IN LM REARRANGED IN LM PRIOR TO A/S JETTISON (22)								
LM COORDINATES								
DESCRIPTION	STCW. ITEM	REF	NO.	STOWAGE LOCATION	WEIGHT	X-C.G.	Y-C.G.	Z-C.G.
DOCKING DROGUE	F1000.	11	1	IN LM TUNNEL	20.0	300.0	.0	.0
TOTAL INITIAL LOCATION LM					20.00	300.00	.00	.00
MISSION H-2 TRANSFERRED CREW AND EQUIPMENT LIST								
ITEMS INITIALLY IN LM REARRANGED IN LM PRIOR TO A/S JETTISON (23)								
LM COORDINATES								
DESCRIPTION	STCW. ITEM	REF	NO.	STOWAGE LOCATION	WEIGHT	X-C.G.	Y-C.G.	Z-C.G.
DOCKING DROGUE	F1000.	11	1	ON CABIN FLOOR	20.0	218.5	-19.6	47.6
TOTAL RELOCATED LM					20.00	218.50	-19.60	47.60

NOTE: Further information relating to this table is given on pages 3.3-18, 3.3-19 and 3.3-20

Table 3.3-9.2 (Continued)

MISSION H-2 TRANSFERRED CREW AND EQUIPMENT LIST								
ITEMS LOCATED IN CM REARRANGED PRIOR TO T.E.I. (24)							APOLLO COORDINATES	
DESCRIPTION	STOW. ITEM	REF	NO.	STORAGE LOCATION	WEIGHT	X-C.G.	Y-C.G.	Z-C.G.
T-ADAPTER CWG ELECTRICAL-CDR.	80135.	1	1	APEA A8	.4	1012.0	22.0	-23.0
T-ADAPTER CWG ELECTRICAL-CMP.	80135.	1	1	AREA A8	.4	1012.0	22.0	-23.0
T-ADAPTER CWG ELECTRICAL-LMP.	80135.	1	1	APEA A8	.4	1012.0	22.0	-23.0
HEADSET, LIGHTWEIGHT-CDR.	E0104.	1	1	AREA A8	.4	1012.0	22.0	-23.0
HEADSET, LIGHTWEIGHT-CMP.	E0104.1	1	1	APEA A8	.4	1012.0	22.0	-23.0
HEADSET LIGHTWEIGHT-LMP.	E0104.	1	1	AREA A8	.4	1012.0	22.0	-23.0
JACKET ASSEMBLY, ICG-CDR.	80112.1	1	1	PGA CONTAINER	1.8	1015.0	.0	-19.9
TROUSEP ASSEMBLY, ICG-CDR.	80112.2	1	1	PGA CONTAINER	1.8	1015.0	.0	-19.9
BOOT ASSEMBLY RIGHT, ICG-CDR.	80112.3	1	1	PGA CONTAINER	.4	1015.0	.0	-19.9
BOOT ASSEMBLY LEFT, ICG-CDR.	80112.4	1	1	PGA CONTAINER	.4	1015.0	.0	-19.9
EARTUBE, UNIVERSAL-CDR.	E0105.1	1	1	ON ICG (PGA CONTAIN)	NEGL	1015.0	.0	-19.0
JACKET ASSEMBLY, ICG-CMP.	80112.1	1	1	PGA CONTAINER	1.8	1015.0	.0	-19.9
TROUSER ASSEMBLY, ICG-CMP.	80112.2	1	1	PGA CONTAINER	1.8	1015.0	.0	-19.9
BOOT ASSEMBLY, RIGHT, ICG-CMP.	80112.3	1	1	PGA CONTAINER	.4	1015.0	.0	-19.9
BOOT ASSEMBLY, LEFT, ICG-CMP.	80112.4	1	1	PGA CONTAINER	.4	1015.0	.0	-19.9
EARTUBE, UNIVERSAL-CMP.	E0105.	1	1	ON ICG (PGA CONTAIN)	NEGL	1015.0	.0	-19.0
JACKET ASSEMBLY, ICG-LMP.	80112.1	1	1	PGA CONTAINER	1.8	1015.0	.0	-19.9
TROUSER ASSEMBLY, ICG-LMP.	80112.2	1	1	PGA CONTAINER	1.8	1015.0	.0	-19.9
BOOT ASSEMBLY, RIGHT, ICG-LMP.	80112.3	1	1	PGA CONTAINER	.4	1015.0	.0	-19.9
BOOT ASSEMBLY, LEFT, ICG-LMP.	80112.4	1	1	PGA CONTAINER	.4	1015.0	.0	-19.9
EARTUBE, UNIVERSAL-LMP.	E0105.1	1	1	ON ICG (PGA CONTAIN)	NEGL	1015.0	.0	-19.0
TORSO AND LIMB SUIT, IV-CMP.	80201.1	4	1	ON CREW- CMP	29.9	1043.0	-24.5	-10.4
PRESSURE HELMET ASSEMBLY-CMP.	80201.2	12	1	ON CREW- CMP	2.4	1043.0	-24.5	-10.4
GLOVES, IV, PAIR-CMP.	80201.3	12	1	ON CREW- CMP	1.6	1043.0	-24.5	-10.4
COMMUNICATION CARRIER-CMP.	80201.4	12	1	ON CREW- CMP	1.6	1043.0	-24.5	-10.4
POCKETS, CHECKLIST+SCISSORS-CMP	80201.5	4	2	ON PGA - CMP	.2	1043.0	-24.5	-11.9
COMMUNICATION CARRIER-CDR.	80200.4	12	1	ON CREW-CDR	1.6	1043.0	.0	-10.4
COMMUNICATION CARRIER-LMP.	80200.4	12	1	ON CREW- LMP	1.6	1043.0	24.5	-10.4
GARMENT, CONSTANT WEAR-CDR.	80208.	6	1	AREA A8	.8	1012.0	22.0	-23.0
GARMENT, CONSTANT WEAR-LMP.	80208.	6	1	AREA A8	.8	1012.0	22.0	-23.0
DECONTAMINATION BAG, ISA	06385.	1	1	APEA A8	T8D	1012.0	22.0	-23.0
BAG, DECONTAM. (TOTE BAG)	06406.	1	1	AREA U1	T8D	1033.0	23.0	-50.0

NOTE: Further information relating to this table is given on pages 3.3-18, 3.3-19 and 3.3-20.

Table 3.3-9.2 (Continued)

MISSION H-2 TRANSFERRED CREW AND EQUIPMENT LIST								
ITEMS LOCATED IN CM REARRANGED PRIOR TO T.E.I. (24)						APOLLO COORDINATES		
DESCRIPTION	STOW. ITEM	REF	NO.	STOWAGE LOCATION	WEIGHT	X-C.G.	Y-C.G.	Z-C.G.
EARPIECE, MOLDED (COM. CAR.)-CMP	E0200.1	1	2	CM CREW- CMP	NEGL	1043.0	-24.5	-10.4
EARTUBE (COM. CARRIER)-CMP	E0200.0	1	2	CM CREW- CMP	NEGL	1043.0	-24.5	-10.4
PROTECTIVE COV. PGA ELECT. CONN.	80138.	1	1	PGA CONTAINER	NEGL	1015.0	.0	-19.9
DECONTAMINATION BAG, CSC CASS.	06328.	4	1	IN SRC BAG NO1	.1	1012.0	22.0	-23.0
DECONTAMINATION BAG, CONTIN, SRC	06329.	4	1	IN SRC BAG NO1	.1	1012.0	22.0	-23.0
DECONTAMINATION BAG, 70MM MAG.	06330.	4	1	IN SRC BAG NO1	.2	1012.0	22.0	-23.0
DECONTAMINATION BAG, SRC NO.1	06331.1	4	1	AREA A8	.9	1012.0	22.0	-23.0
DECONTAMINATION BAG, SRC NO.2	06331.	4	1	IN SRC BAG NO1	.9	1012.0	22.0	-23.0
BAG, DECONTAM, LS HASSELBLAD MAG	06369.	4	1	IN SRC BAG NO1	.2	1012.0	22.0	-23.0
BAG, RETURN EQUIPMENT	06394.	1	1	AREA A8	TBD	1012.0	22.0	-23.0
TOTAL INITIAL LOCATICN CM					58.53	1033.28	-11.86	-13.94

NOTE: Further information relating to this table is given on pages 3.3-18, 3.3-19 and 3.3-20

Table 3.3-9.2 (Continued)

MISSION H-2 TRANSFERRED CREW AND EQUIPMENT LIST								
ITEMS LOCATED IN CM REARRANGED PRIOR TO T.E.I. (25)								
APOLLO COORDINATES								
DESCRIPTION	STCW. ITEM	REF	NO.	STORAGE LOCATION	WEIGHT	X-C.G.	Y-C.G.	Z-C.G.
T-ADAPTER CWG ELECTRICAL-CDR.	B0135.	1	1	ON CREW-CDR	.4	1043.0	.0	-10.4
T-ADAPTER CWG ELECTRICAL-CMP.	BC135.	1	1	ON CREW- CMP	.4	1043.0	-24.5	-10.4
T-ADAPTER CWG ELECTRICAL-LMP.	B0135.	1	1	ON CREW- LMP	.4	1043.0	24.5	-10.4
HEADSET, LIGHTWEIGHT-CDR.	E0104.	1	1	ON CREW-CDR	.4	1043.0	.0	-10.4
HEADSET, LIGHTWEIGHT-CMP.	E0104.1	1	1	ON CREW- CMP	.4	1043.0	-24.5	-10.4
HEADSET LIGHTWEIGHT-LMP.	E0104.	1	1	ON CREW- LMP	.4	1043.0	24.5	-10.4
JACKET ASSEMBLY, ICG-CDR.	B0112.1	1	1	ON CREW-CDR	1.8	1043.0	.0	-10.4
TROUSER ASSEMBLY, ICG-CDR.	B0112.2	1	1	ON CREW-CDR	1.8	1043.0	.0	-10.4
BOOT ASSEMBLY RIGHT, ICG-CDR.	B0112.3	1	1	ON CREW-CDR	.4	1043.0	.0	-10.4
BOOT ASSEMBLY LEFT, ICG-CDR.	B0112.4	1	1	ON CREW-CDR	.4	1043.0	.0	-10.4
EARTUBE, UNIVERSAL-CDR.	E0105.1	1	1	ON ICG (ON CREW-CDR)	NEGL	1043.0	.0	-10.4
JACKET ASSEMBLY, ICG-CMP.	B0112.1	1	1	ON CREW- CMP	1.8	1043.0	-24.5	-10.4
TROUSER ASSEMBLY, ICG-CMP.	B0112.2	1	1	ON CREW- CMP	1.8	1043.0	-24.5	-10.4
BOOT ASSEMBLY, RIGHT, ICG-CMP.	B0112.3	1	1	ON CREW- CMP	.4	1043.0	-24.5	-10.4
BOOT ASSEMBLY, LEFT, ICG-CMP.	B0112.4	1	1	ON CREW- CMP	.4	1043.0	-24.5	-10.4
EARTUBE, UNIVERSAL-CMP.	E0105.	1	1	ON ICG (ON CREW-CMP)	NEGL	1043.0	-24.5	-10.4
JACKET ASSEMBLY, ICG-LMP.	B0112.1	1	1	ON CREW- LMP	1.8	1043.0	24.5	-10.4
TROUSER ASSEMBLY, ICG-LMP.	B0112.2	1	1	ON CREW- LMP	1.8	1043.0	24.5	-10.4
BOOT ASSEMBLY, RIGHT, ICG-LMP.	B0112.3	1	1	ON CREW- LMP	.4	1043.0	24.5	-10.4
BOOT ASSEMBLY, LEFT, ICG-LMP.	B0112.4	1	1	ON CREW- LMP	.4	1043.0	24.5	-10.4
EARTUBE, UNIVERSAL-LMP.	E0105.1	1	1	ON ICG (ON CREW-LMP)	NEGL	1043.0	24.5	-10.4
TORSO AND LIMB SUIT, IV-CMP.	B0201.1	4	1	SLEEP RESTRAINT-RH	29.9	1018.0	24.5	-15.0
PRESSURE HELMET ASSEMBLY-CMP.	B0201.2	12	1	SLEEP RESTRAINT-RH	2.4	1018.0	24.5	-15.0
GLOVES, IV, PAIR-CMP.	B0201.3	12	1	SLEEP RESTRAINT-RH	1.6	1018.0	24.5	-15.0
COMMUNICATION CARRIER-CMP.	B0201.4	12	1	ACCESSORY BAG-CMP	1.6	1039.0	-47.0	12.0
POCKETS, CHECKLIST+SCISSORS-CMP	B0201.5	4	2	ON ICG (ON CREW-CMP)	.2	1043.0	-24.5	-10.4
COMMUNICATION CARRIER-CDR.	B0200.4	12	1	ACCESSORY BAG-CDR.	1.6	1050.0	-27.0	39.0
COMMUNICATION CARRIER-LMP.	B0200.4	12	1	ACCESSORY BAG-LMP.	1.6	1039.0	47.0	12.0
GARMENT, CONSTANT WEAR-CDR.	B0208.	6	1	ON CREW-CDR	.8	1043.0	.0	-10.4
GARMENT, CONSTANT WEAR-LMP.	B0208.	6	1	ON CREW- LMP	.8	1043.0	24.5	-10.4
DECONTAMINATION BAG, ISA	O6385.	1	1	AREA A1	T80	1012.0	-22.0	-26.0
BAG, DECONTAM. (TOTE BAG)	O6406.	1	1	ON A7 + A11	T80	1011.5	25.0	7.0

NOTE: Further information relating to this table is given on pages 3.3-18, 3.3-19 and 3.3-20.

Table 3.3-9.2 (Continued)

MISSION H-2 TRANSFERRED CREW AND EQUIPMENT LIST								
ITEMS LOCATED IN CM REARRANGED PRIOR TO T.E.I. (25)								
APOLLO COORDINATES								
DESCRIPTION	STOW. ITEM	REF	NO.	STOWAGE LOCATION	WEIGHT	X-C.G.	Y-C.G.	Z-C.G.
EARPIECE, MOLDED (COM. CAR.)-CMP	E0200.1	1	2	ACCESSORY BAG-CMP	NEGL	1039.0	-47.0	12.0
EARTUBE (COM. CARRIER)-CMP	E0200.0	1	2	ACCESSORY BAG-CMP	NEGL	1039.0	-47.0	12.0
PROTECTIVE COV. PGA ELECT. CONN.	B0138.	1	1	SLEEP RESTRAINT-RH	NEGL	1018.0	24.5	-15.0
DECONTAMINATION BAG, CSC CASS.	06328.	4	1	AREA A5	.1	1015.0	9.0	28.0
DECONTAMINATION BAG, CONTIN, SRC	06329.	4	1	AREA A5	.1	1015.0	9.0	28.0
DECONTAMINATION BAG, 70MM MAG.	06330.	4	1	AREA R13	.2	1024.0	45.0	-26.0
DECONTAMINATION BAG, SFC NO.1	06331.1	4	1	AREA B6	.9	1031.0	13.0	39.0
DECONTAMINATION BAG, SRC NO.2	06331.	4	1	AREA B5	.9	1031.0	-8.0	39.0
BAG, DECONTAM, LS HASSELBLAD MAG	06369.	4	1	AREA R13	.2	1024.0	45.0	-26.0
BAG, RETURN EQUIPMENT	06394.	1	1	AREA B1	TBD	1050.0	-27.0	39.0
TOTAL RELOCATED CM					58.53	1027.89	14.11	-8.94

NOTE: Further information relating to this table is given on pages 3.3-18, 3.3-19 and 3.3-20

Table 3.3-9.2 (continued)

MISSION H-2 TRANSFERRED CREW AND EQUIPMENT LIST								
ITEMS LOCATED IN CM REARRANGED PRIOR TO ENTRY (26)								
APOLLO COORDINATES								
DESCRIPTION	STOW. ITEM	REF	NO.	STOWAGE LOCATION	WEIGHT	X-C.G.	Y-C.G.	Z-C.G.
CONTAINER, TEMPORARY STOW.-CDR.	00301.	1	1	LOWER EQUIP BAY	1.7	1050.0	-27.0	39.0
CONTAINER, TEMPORARY STOW.-CMP.	00301.	1	1	LH GIRTH RING	1.7	1036.5	-40.0	-25.0
CONTAINER, TEMPORARY STOW.-LMP.	00301.	1	1	RH GIRTH RING	1.7	1036.5	40.0	-25.0
BAG, MOTION SICKNESS-CMP.	A0208.	1	1	PGA CONTAINER	.1	1015.0	.0	-19.9
ACCESSORY BAG-CDR.	B0105.1	1	1	LOWER EQUIP BAY	.3	1050.0	-27.0	39.0
ACCESSORY BAG-CMP.	B0105.1	1	1	LH GIRTH RING	.3	1036.5	-40.0	-25.0
ACCESSORY BAG-LMP.	B0105.1	1	1	RH GIRTH RING	.3	1036.5	40.0	-25.0
BAG, HELMET STOWAGE-CDR.	B0105.	2	1	LOWER EQUIP BAY	.9	1050.0	-27.0	39.0
BAG, HELMET STOWAGE-CMP.	B0105.	2	1	LH EQUIPMENT BAY	.9	1039.0	-47.0	12.0
BAG, HELMET STOWAGE-LMP.	B0105.	2	1	RH EQUIPMENT BAY	.9	1039.0	47.0	12.0
HEADSET, LIGHTWEIGHT-CDR.	E0104.	1	1	ON CREW-CDR	.4	1043.0	.0	-10.4
HEADSET, LIGHTWEIGHT-CMP.	E0104.1	1	1	ON CREW- CMP	.4	1043.0	-24.5	-10.4
HEADSET LIGHTWEIGHT-LMP.	E0104.	1	1	ON CREW- LMP	.4	1043.0	24.5	-10.4
SLEEP RESTRAINT ASSEMBLY, L.H.	00322.	1	1	UNDER LH COUCH	3.7	1018.0	-24.5	-15.0
SLEEP RESTRAINT ASSEMBLY, R.H.	00323.	1	1	UNDER RH COUCH	3.7	1018.0	24.5	-15.0
CONTAINER R12	00344.	1	1	RH GIRTH RING	2.7	1036.5	40.0	-25.0
COMMUNICATION CARRIER-CMP.	B0201.4	12	1	ACCESSORY BAG-CMP	1.6	1039.0	-47.0	12.0
COMMUNICATION CARRIER-CDR.	B0200.4	12	1	ACCESSORY BAG-CDR.	1.6	1050.0	-27.0	39.0
COMMUNICATION CARRIER-LMP.	B0200.4	12	1	ACCESSORY BAG-LMP.	1.6	1039.0	47.0	12.0
EARPIECE, MOLDED (COM. CAR.)-CMP	E0200.1	1	2	ACCESSORY BAG-CMP	NEGL	1039.0	-47.0	12.0
EAF TUBE (COM. CARRIER)-CMP	E0200.0	1	2	ACCESSORY BAG-CMP	NEGL	1039.0	-47.0	12.0
CASSETTE, CSC	J4001.	10	1	TEMP. STOW. BAG-LMP	.4	1036.5	40.0	-25.0
HEADREST-CDR.	B0130.	1	1	AREA A5	1.1	1015.0	9.0	28.0
HEADREST-CMP.	B0130.	1	1	AREA A5	1.1	1015.0	9.0	28.0
HEADREST-LMP.	B0130.	1	1	AREA A5	1.1	1015.0	9.0	28.0
HEEL RESTRAINT-CDR.	B0132.	1	1	AREA A5	1.2	1015.0	9.0	28.0
HEEL RESTRAINT-CMP.	B0132.	1	1	AREA A5	1.2	1015.0	9.0	28.0
HEEL RESTRAINT-LMP.	B0132.	1	1	AREA A5	1.2	1015.0	9.0	28.0
CSM LUNAR LANDMARK MAP	A0114.5	4	1	CONT. R12 (RH GRTH. RG)	.6	1036.5	40.0	-25.0
CSM SYSTEMS DATA	A0114.7	4	1	CONT. R12 (RH GRTH. RG)	.9	1036.5	40.0	-25.0
CSM MALFUNCTION PROCEDURES	A0114.8	4	1	CONT. R12 (RH GRTH. RG)	.6	1036.5	40.0	-25.0

NOTE: Further information relating to this table is given on pages 3.3-18, 3.3-19 and 3.3-20.

Table 3.3-9.2 (Continued)

MISSION H-2 TRANSFERRED CREW AND EQUIPMENT LIST								
ITEMS LOCATED IN CM REARRANGED PRIOR TO ENTRY (27)								
APOLLO COORDINATES								
DESCRIPTION	STOW. ITEM	REF	NO.	STORAGE LOCATION	WEIGHT	X-C.G.	Y-C.G.	Z-C.G.
CONTAINER,TEMPORARY STOW.-CDR.	00301.	1	1	AREA A1	1.7	1012.0	-22.0	-26.0
CONTAINER,TEMPORARY STOW.-CMP.	00301.	1	1	AREA A1	1.7	1012.0	-22.0	-26.0
CONTAINER,TEMPORARY STOW.-LMP.	00301.	1	1	AREA A1	1.7	1012.0	-22.0	-26.0
BAG,MOTION SICKNESS-CMP.	A0208.	1	1	SLEEP RESTRAINT-RH	.1	1018.0	24.5	-15.0
ACCESSORY BAG-CDR.	80105.1	1	1	AREA B1	.3	1050.0	-27.0	39.0
ACCESSORY BAG-CMP.	80105.1	1	1	AREA R6	.3	1048.0	46.0	29.0
ACCESSORY BAG-LMP.	80105.1	1	1	AREA L3	.3	1048.0	-47.0	12.0
BAG,HELMET STOWAGE-CDR.	80105.	2	1	AREA R6	.9	1048.0	46.0	29.0
BAG,HELMET STOWAGE-CMP.	80105.	2	1	AREA B1	.9	1050.0	-27.0	39.0
BAG,HELMET STOWAGE-LMP.	80105.	2	1	AREA L3	.9	1048.0	-47.0	12.0
HEADSET,LIGHTWEIGHT-CDR.	E0104.	1	1	AREA AB	.4	1012.0	22.0	-23.0
HEADSET,LIGHTWEIGHT-CMP.	E0104.1	1	1	AREA AB	.4	1012.0	22.0	-23.0
HEADSET,LIGHTWEIGHT-LMP.	E0104.	1	1	AREA AB	.4	1012.0	22.0	-23.0
SLEEP RESTRAINT ASSEMBLY,L.H.	00322.	1	1	AFT UPR EQUIP BAY-LH	3.7	1018.0	-21.9	-49.9
SLEEP RESTRAINT ASSEMBLY,R.H.	00323.	1	1	AFT UPR EQUIP BAY-RH	3.7	1018.0	25.0	-47.9
CONTAINER R12	00344.	1	1	AREA R3	2.7	1072.0	26.0	9.0
COMMUNICATION CARRIER-CMP.	80201.4	12	1	ON CREW- CMP	1.6	1043.0	-24.5	-10.4
COMMUNICATION CARRIER-CDR.	80200.4	12	1	ON CREW-CDR	1.6	1043.0	.0	-10.4
COMMUNICATION CARRIER-LMP.	80200.4	12	1	ON CREW- LMP	1.6	1043.0	24.5	-10.4
EARPIECE,MOLDED(COM. CAR.)-CMP	E0200.1	1	2	ON CREW- CMP	NEGL	1043.0	-24.5	-10.4
EARTUBE (COM. CARRIER)-CMP	E0200.0	1	2	ON CREW- CMP	NEGL	1043.0	-24.5	-10.4
CASSETTE, CSC	J4001.	10	1	AREA A5	.4	1015.0	9.0	28.0
HEADREST-CDR.	80130.	1	1	CENTER COUCH	1.1	1043.0	.0	-10.4
HEADREST-CMP.	80130.	1	1	RIGHT COUCH	1.1	1043.0	24.5	-10.4
HEADREST-LMP.	80130.	1	1	LEFT COUCH	1.1	1043.0	-24.5	-10.4
HEEL RESTRAINT-CDR.	80132.	1	1	ON CREW-CDR	1.2	1043.0	.0	-10.4
HEEL RESTRAINT-CMP.	80132.	1	1	ON CREW- CMP	1.2	1043.0	-24.5	-10.4
HEEL RESTRAINT-LMP.	80132.	1	1	ON CREW- LMP	1.2	1043.0	24.5	-10.4
CSM LUNAR LANDMARK MAP	A0114.5	4	1	CONT.R12(AREA R3)	.6	1072.0	26.0	9.0
CSM SYSTEMS DATA	A0114.7	4	1	CONT.R12(AREA R3)	.9	1072.0	26.0	9.0
CSM MALFUNCTION PROCEDURES	A0114.8	4	1	CONT.R12(AREA R3)	.6	1072.0	26.0	9.0

NOTE: Further information relating to this table is given on pages 3.3-18, 3.3-19 and 3.3-20.

Table 3.3-9.2 (Continued)

MISSION H-2 TRANSFERRED CREW AND EQUIPMENT LIST								
ITEMS LOCATED IN CM REARRANGED PRIOR TO ENTRY (27)							APOLLO COORDINATES	
DESCRIPTION	STOW. ITEM	REF	NO.	STORAGE LOCATION	WEIGHT	X-C.G.	Y-C.G.	Z-C.G.
REENTRY PLAN	A0114.0	4	1	CONT. R12 (AREA R3)	1.0	1072.0	26.0	9.0
CM EGRESS BOOK	A0114.11	4	1	CONT. R12 (AREA R3)	.9	1072.0	26.0	9.0
RESCUE BOOK	A0114.15	4	1	CONT. R12 (AREA R3)	.9	1072.0	26.0	9.0
CM LAUNCH CHECKLIST	A0114.1	4	2	CONT. R12 (AREA R3)	1.0	1072.0	26.0	9.0
CM G AND C CHECKLIST	A0114.2	4	2	CONT. R12 (AREA R3)	1.0	1072.0	26.0	9.0
CM SYSTEMS CHECKLIST	A0114.3	4	2	CONT. R12 (AREA R3)	1.0	1072.0	26.0	9.0
TOTAL RELOCATED CM					42.10	1042.81	5.36	-10.09

NOTE: Further information relating to this table is given on pages 3.3-18, 3.3-19 and 3.3-20

TABLE 3.3-9.2 (Continued)

MISSION 4-2 TRANSFERRED CREW AND EQUIPMENT STOWAGE LIST								
ITEMS LOCATED IN CM REARRANGED PRIOR TO ENTRY								
APOLLO COORDINATES								
DESCRIPTION	STOW. ITEM	REF	NO.	STOWAGE LOCATION	WEIGHT	X-C.G.	Y-C.G.	Z-C.G.
CONTAINER, TEMPORARY STOW.-CDR.	00301.	1	1	AREA A1	1.7	1012.0	-22.0	-26.0
CONTAINER, TEMPORARY STOW.-CMP.	00301.	1	1	AREA A1	1.7	1012.0	-22.0	-26.0
CONTAINER, TEMPORARY STOW.-LMP.	00301.	1	1	AREA A1	1.7	1012.0	-22.0	-26.0
BAG, MOTION SICKNESS-CMP.	A0208.	1	1	SLEEP RESTRAINT-RH	.1	1018.0	24.5	-15.0
ACCESSORY BAG-CDR.	B0105.1	1	1	AREA B1	.3	1050.0	-27.0	39.0
ACCESSORY BAG-CMP.	B0105.1	1	1	AREA R6	.3	1048.0	45.0	29.0
ACCESSORY BAG-LMP.	B0105.1	1	1	AREA L3	.3	1048.0	-47.0	12.0
BAG, HELMET STOWAGE-CDR.	B0105.	2	1	AREA R6	.9	1048.0	46.0	29.0
BAG, HELMET STOWAGE-CMP.	B0105.	2	1	AREA B1	.9	1050.0	-27.0	39.0
BAG, HELMET STOWAGE-LMP.	B0105.	2	1	AREA L3	.9	1048.0	-47.0	12.0
HEADSET, LIGHTWEIGHT-CDR.	E0104.	1	1	AREA A8	.4	1012.0	22.0	-23.0
HEADSET, LIGHTWEIGHT-CMP.	E0104.1	1	1	AREA A8	.4	1012.0	22.0	-23.0
HEADSET LIGHTWEIGHT-LMP.	E0104.	1	1	AREA A8	.4	1012.0	22.0	-23.0
SLEEP RESTRAINT ASSEMBLY, L.H.	C0322.	1	1	AFT UPR EQUIP BAY-LH	3.7	1018.0	-21.9	-49.9
SLEEP RESTRAINT ASSEMBLY, R.H.	C0323.	1	1	AFT UPR EQUIP BAY-RH	3.7	1018.0	25.0	-47.9
CONTAINER R12	D0344.	1	1	AREA R3	2.7	1072.0	27.0	9.0
COMMUNICATION CARRIER-CMP.	B0200.4	12	1	ON CREW- CMP	1.6	1043.0	-24.5	-10.4
COMMUNICATION CARRIER-CDR.	B0200.4	12	1	ON CREW-CDR	1.6	1043.0	.0	-10.4
COMMUNICATION CARRIER-LMP.	B0200.4	12	1	ON CREW- LMP	1.6	1043.0	24.5	-10.4
CASSETTE, CSC	J4001.	3	1	AREA A5	.5	1015.0	8.0	27.5
HEADREST-CDR.	B0130.	1	1	CENTER COUCH	1.1	1043.0	.0	-10.4
HEADREST-CMP.	B0130.	1	1	RIGHT COUCH	1.1	1043.0	24.5	-10.4
HEADREST-LMP.	B0130.	1	1	LEFT COUCH	1.1	1043.0	-24.5	-10.4
HEEL RESTRAINT-CDR.	B0132.	1	1	ON CREW-CDR	.6	1043.0	.0	-10.4
HEEL RESTRAINT-CMP.	B0132.	1	1	ON CREW- CMP	.6	1043.0	-24.5	-10.4
HEEL RESTRAINT-LMP.	B0132.	1	1	ON CREW- LMP	.6	1043.0	24.5	-10.4
CSM LUNAR LANDMARK MAP	A0114.5	4	1	CONT. R12 (AREA R3)	.6	1072.0	27.0	9.0
CSM SYSTEMS DATA	A0114.7	4	1	CONT. R12 (AREA R3)	.9	1072.0	27.0	9.0
CSM MALFUNCTION PROCEDURES	A0114.8	4	1	CONT. R12 (AREA R3)	.6	1072.0	27.0	9.0
FLIGHT PLAN	A0114.9	4	1	CONT. R12 (AREA R3)	3.0	1072.0	27.0	9.0

NOTE: Further information relating to this table is given on pages 3.3-18, 3.3-19 and 3.3-20

TABLE 3.3-9.2 (Continued)

MISSION H-2 TRANSFERRED CREW AND EQUIPMENT STOWAGE LIST									
ITEMS LOCATED IN CM REARRANGED PRIOR TO ENTRY									
APOLLO COORDINATES									
DESCRIPTION	STOW. ITEM	REF	NO.	STOWAGE LOCATION	WEIGHT	X-C.G.	Y-C.G.	Z-C.G.	
CMP SOLE BOOK	A0114.11	4	1	CCNT. R12 (AREA R3)	.9	1072.0	27.0	9.0	
RESCUE BOOK	A0114.15	4	1	CCNT. R12 (AREA R3)	.9	1072.0	27.0	9.0	
ALTERNATE+CONTINGENCY CHKLIST	A0114.1	4	1	CCNT. R12 (AREA R3)	.5	1072.0	27.0	9.0	
LAUNCH OPERATIONS CHECKLIST	A0114.2	4	1	CCNT. R12 (AREA R3)	.5	1072.0	27.0	9.0	
LAUNCH OPERATIONS CHECKLIST	A0114.2	4	1	CCNT. R12 (AREA R3)	.5	1072.0	27.0	9.0	
OPERATIONS CHECKLIST	A0114.3	4	1	CCNT. R12 (AREA R3)	.5	1072.0	27.0	9.0	
TOTAL RELOCATED CM					39.40	1041.98	5.37	-10.47	

NOTE: Further information relating to this table is given on pages 3.3-18, 3.3-19 and 3.3-20

TABLE 3.3-10 (Continued)
Command Module Water and GOX

	Pressure (PSIA)	Loading Requirement Weight (lb)	Earth Launch Weight (lb)	Actual
Waste Water ⁶			18.0	*11 lbs
Potable Water ⁷			36.0	*30 lbs
CM/GOX	900±50	3.7	6.7 (Entry)	

*As serviced, predicted at lift-off; Waste Water 38.0 lbs, Potable Water 31.4 lbs.

⁸Service Module Hydrogen and Oxygen

	Loading Req. Per Tank (pounds)	Earth Launch Weight Per Tank (lb)
Hydrogen	29.3	27.6
Oxygen	330.1	316.6

NOTES:

¹Indicated propellant load is based on nominal pressure and temperature prior to actual loading. This number will be updated after loading is accomplished.

²See Section 4.1 for explanation of trapped SPS propellant.

³See Table 3.3-13 for loading uncertainties.

⁴See Section 4.2 for SM/RCS loads and uncertainties to be used in Mission Planning. Actual SM/RCS loads and uncertainties will be published in Table 3.3-15.

⁵See Section 4.2 for CM/RCS loads and uncertainties to be used in Mission Planning. Actual CM/RCS loads and uncertainties will be published in Table 3.3-14.

⁶Launch Rule Redlines determine lift-off values.

⁷Launch Rule Redlines determine lift-off values.

⁸Launch Mission Rules will determine minimum lift-off quantities for H₂ and O₂.

⁹CSM helium and nitrogen should be loaded in accordance with loading windows contained in CSM/LM Spacecraft Operational Data Book, Volume I, Part 2, SNA-8-D-027(1) P2.



TABLE 3.3-11

SPS Propellant Load Calculation

	<u>FUEL</u>	<u>OXIDIZER</u>
1. Enter SPS Quantity Readout at 110 PSIA (Table 3.3-12 item C - Percent)	<u>100.8</u>	<u>100.9</u>
2. Use Figures 4.1-3 and 4.1-4 to obtain propellant load for above quantity readout.	<u>15588.0</u>	<u>25092.0</u>
3. Nominal propellant density at loading temperature (use temperature - density graph below) (lb/ft ³)	<u>56.35</u>	<u>90.44</u>
4. Cubic feet of propellant (item 2 divided by item 3)	<u>278.403</u>	<u>277.443</u>
5. Calculated density from Table 3.3-12 item f (lb/ft ³)	<u>56.34</u>	<u>90.41</u>
6. Adjustment due to PUGS zero adjust (pounds)	<u>0.0</u>	<u>0.0</u>
7. Resulting actual propellant load (item 4 times item 5, less item 6) (pounds)	<u>15685.2</u>	<u>25083.7</u>

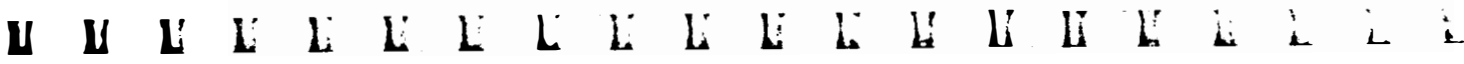
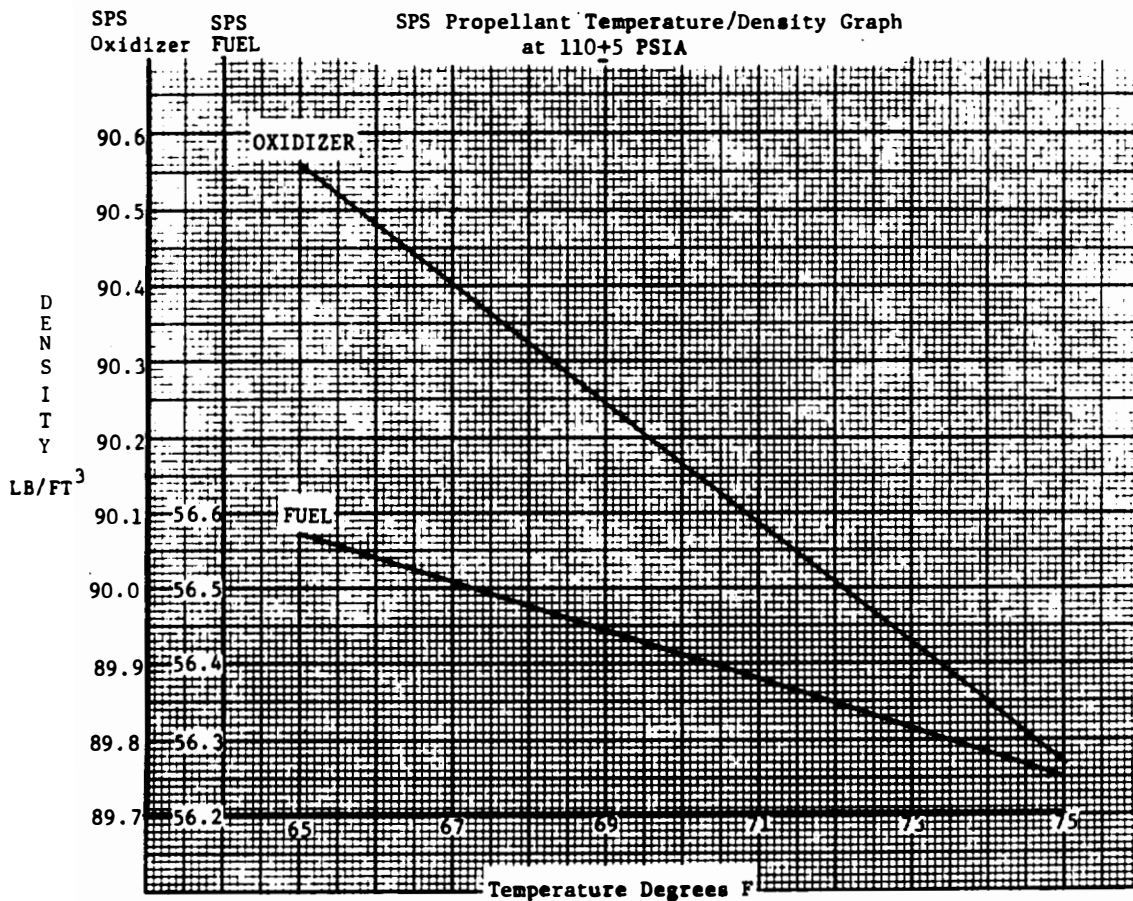

TABLE 3.3-12

Mission H-2 SPS Propellant Load Parameters
(To be provided by KSC following loading)

Enter the following information at zero adjust - time			
<u>Fuel</u>		<u>Oxidizer</u>	
Adjusted quantity fuel readout - Percent	<u>0.0</u>	Adjusted quantity oxidizer readout - Percent	<u>0.0</u>
Fuel storage voltage reading taken from ACE to three significant digits - volts	<u>0.0</u>	Oxidizer storage voltage reading taken from ACE to three significant digits - volts	<u>0.0</u>
Fuel sump voltage reading taken from ACE to three significant digits - volts	<u>0.0</u>	Oxidizer sump voltage reading taken from ACE to three significant digits - volts	<u>0.0</u>

Enter the following information at Sump Tank Full Adjust (Propellant at top of standpipe)			
<u>Fuel</u>		<u>Oxidizer</u>	
Fuel sump tank pressure - PSIA	<u>27.0</u>	Oxidizer sump tank pressure - PSIA	<u>31</u>
Fuel temperature - °F	<u>72.0</u>	Oxidizer temperature - °F	<u>67.0</u>
Adjusted quantity fuel readout - Percent	<u>55.08</u>	Adjusted quantity oxidizer readout - %	<u>55.3</u>
Fuel sump voltage reading taken from ACE to three significant digits - volts	<u>4.58</u>	Oxidizer sump voltage reading taken from ACE to three significant digits - volts	<u>4.61</u>

Enter the following information at Storage Tank Full Adjust (Propellant at Point Sensor #1)			
<u>Fuel</u>		<u>Oxidizer</u>	
Fuel storage tank pressure - PSIA	<u>108.0</u>	Oxidizer storage tank pressure - PSIA	<u>105.0</u>
Fuel temperature - °F	<u>72.0</u>	Oxidizer temperature - °F	<u>66.6</u>
Adjusted quantity fuel readout - %	<u>96.06</u>	Adjusted quantity oxidizer readout - %	<u>96.00</u>
Fuel storage voltage reading taken from ACE to three significant digits - volts	<u>4.08</u>	Oxidizer storage voltage reading taken from ACE to three significant digits - volts	<u>4.07</u>
Fuel sump voltage reading taken from ACE to three significant digits - volts	<u>4.63</u>	Oxidizer sump voltage reading taken from ACE to three significant digits - volts	<u>4.63</u>

TABLE 3.3-12 (Continued)

Enter the following information when tanking is complete (110±5 PSIA) Time			
<u>Fuel</u>		<u>Oxidizer</u>	
a. System pressure - PSIA	<u>111.0</u>	a. System pressure - PSIA	<u>110.0</u>
b. Fuel temperature - °F	<u>72.0</u>	b. Oxidizer temperature - °F	<u>66.6</u>
c. Quantity fuel readout - %	<u>100.8</u>	c. Quantity oxidizer readout - %	<u>100.9</u>
d. Fuel measured specific gravity @25°C - 14.7 PSIA	<u>0.8992</u>	d. Oxidizer measured specific gravity @4°C - 14.7 PSIA	<u>1.4817</u>
e. Fuel measured density ^{25°C} - 14.7 PSIA (Item d times 62.428) - lb/ft ³	<u>56.135</u>	e. Oxidizer measured density @4°C - 14.7 PSIA (Item d times 62.428) - lb/ft ³	<u>92.5</u>
f. Calculated density - lb/ft ³ - at system pressure and temperature Items a and b above. Use density equation outlined in Section 4.1.	<u>56.34</u>	f. Calculated density - lb/ft ³ - at system pressure and temperature, Item a and b above. Use density equation outlined in Section 4.1.	<u>90.41</u>
g. Fuel storage voltage reading from ACE	<u>4.57</u>	g. Oxidizer storage voltage reading from ACE	<u>4.55</u>
h. Fuel sump voltage reading from ACE	<u>4.62</u>	h. Oxidizer sump voltage reading from ACE	<u>4.65</u>

Enter the following information at leak check pressure			
<u>Fuel</u>		<u>Oxidizer</u>	
System pressure - PSIA	<u>190.0</u>	System pressure - PSIA	<u>190.0</u>
Quantity fuel readout - %	<u>100.58</u>	Quantity oxidizer readout - %	<u>100.54</u>
Fuel storage voltage reading from ACE	<u>4.41</u>	Oxidizer storage voltage readout from ACE	<u>4.37</u>
Fuel sump voltage reading from ACE	<u>4.73</u>	Oxidizer sump voltage readout from ACE	<u>4.77</u>

TABLE 3.3-13
SPS PROPELLANT UNCERTAINTIES

Amendment 79
 3/30/70

ITEM	FUEL (lb)	OXIDIZER (lb)
<u>LOADING UNCERTAINTIES</u>		
Tank Volume	±24	±39
Temperature Gauge (±2.0°F)	±18	±46
Standpipe Height	± 6	±10
Propellant Gauge (±0.35% of Gaugeable)	±54	±86
Density Measurement (1)	± 5	± 5
Batch Density (1)	± 0	± 0
Loading Pressure (1)	± 8	±14
RSS	± 63	±107
TOTAL RSS	±124	
Loading Specification (1) (2)	± 0	± 0
Tolerance on Propellant Temperature of Flight Load	± 0	± 0
TOTAL LOADING UNCERTAINTY	±124	
<u>MISSION UNCERTAINTIES</u>		
Mixture Ratio Variation	+ 65.5	-512.7
ΔV , I_{sp} , Vehicle Weight Variation	+422.2	-419.0
Propellant usage uncertainty due to total loading uncertainty	+ 75.9	-132.4
TOTAL PROPELLANT UNCERTAINTY FOR MISSION ΔV	+434.0	-675.3

NOTES: (1) Data will be known after loading is accomplished.

(2) Loading specification is an allowable tolerance about nominal, this number is added to the loading uncertainty variables.

M U E E E E E E E E E E E E E E E E

TABLE 3.3-14

Command Module RCS Loading Parameters and Calculations

This table will be completed when loading is accomplished. For Mission Planning, reference should be made to Section 4.2 for nominal load, loading tolerances, trapped and deliverable propellants.

	<u>FUEL</u>		<u>OXIDIZER</u>	
	<u>Tank A</u>	<u>Tank B</u>	<u>Tank A</u>	<u>Tank B</u>
A. Tank Volume @ 0.0 PSIA (in ³)	<u>1472.8</u>	<u>1474.7</u>	<u>1789.2</u>	<u>1787.0</u>
B. Liquid Line Volume (in ³)	<u>21.0</u>	<u>17.4</u>	<u>17.1</u>	<u>16.4</u>
C. Total A + B (in ³)	<u>1493.8</u>	<u>1492.1</u>	<u>1806.3</u>	<u>1803.4</u>
D. Initial Weight in Bleed Unit Prior to Loading (lb)	<u>148.6</u>	<u>103.3</u>	<u>196.6</u>	<u>116.7</u>
E. Final Weight in Bleed Unit After Loading (lb)	<u>104.4</u>	<u>59.1</u>	<u>118.3</u>	<u>38.4</u>
F. Propellant Load (item D less than E Weigh Tank)	<u>44.2</u>	<u>44.2</u>	<u>78.3</u>	<u>78.3</u>
G. Propellant Load by P.V.	<u>44.2</u>	<u>44.6</u>	<u>77.8</u>	<u>78.5</u>
H. Loading Temperature (°F)	<u>70.0</u>	<u>70.0</u>	<u>69.0</u>	<u>69.0</u>
I. Specification Propellant Load @ 70±5°F (lb)	<u>44.2</u>	<u>44.2</u>	<u>78.3</u>	<u>78.3</u>
J. Total CM/RCS Propellant Load from Item G above (lb)	<u>88.8</u>		<u>156.3</u>	
K. Maximum Trapped Propellant (lb)	<u>13.3</u>		<u>23.1</u>	
L. Nominal Deliverable (lb)	<u>75.5</u>		<u>133.2</u>	

U U

TABLE 3.3-15

SERVICE MODULE RCS LOADING SUMMATION

This table will be completed when loading is accomplished. For Mission Planning, reference should be made to Section 4.2, for nominal load, loading tolerances, and nominal deliverable propellants.

<u>Quad A (lb)</u>		<u>Quad B (lb)</u>	
Secondary fuel*	<u>40.2</u>	Secondary fuel *	<u>39.8</u>
Primary fuel	<u>70.2</u>	Primary Fuel	<u>69.7</u>
Total fuel	<u>110.4</u> ±0.7	Total fuel	<u>109.5</u> ±0.7
Maximum Trapped	<u>2.1</u>	Maximum Trapped	<u>2.1</u>
Nominal Deliverable	<u>108.3</u>	Nominal Deliverable	<u>107.4</u>
Total Oxidizer	<u>225.6</u> ±2.3	Total Oxidizer	<u>225.5</u> ±2.3
Maximum Trapped	<u>4.5</u>	Maximum Trapped	<u>4.5</u>
Nominal Deliverable	<u>221.1</u>	Nominal Deliverable	<u>221.0</u>
<u>Quad C (lb)</u>		<u>Quad D (lb)</u>	
Secondary fuel*	<u>40.0</u>	Secondary fuel* =	<u>39.8</u>
Primary fuel	<u>70.1</u>	Primary fuel	<u>70.1</u>
Total fuel	<u>110.1</u> ±0.7	Total fuel	<u>110.1</u> ±0.7
Maximum Trapped	<u>2.1</u>	Maximum Trapped	<u>2.1</u>
Nominal Deliverable	<u>108.0</u>	Nominal Deliverable	<u>108.0</u>
Total Oxidizer	<u>225.4</u> ±2.3	Total Oxidizer	<u>226.2</u> ±2.3
Maximum Trapped	<u>4.5</u>	Maximum Trapped	<u>4.5</u>
Nominal Deliverable	<u>220.9</u>	Nominal Deliverable	<u>221.7</u>
<u>Total SM/RCS Propellant Load (lb)</u>			
Total fuel	<u>440.1</u> ±1.4	Total Oxidizer	<u>902.7</u> ±4.6
Maximum Trapped	<u>8.4</u>	Maximum Trapped	<u>18.0</u>
Nominal Deliverable	<u>431.7</u>	Nominal Deliverable	<u>884.7</u>

*Secondary fuel load for all quads determined by P. V. calculations.



TABLE 3.3-16

LM-7 Consumable Loading Requirements

LM-7 APS Propellant

	<u>Fuel (lb)</u>	<u>Oxidizer (lb)</u>
Propellant Load	2014.2	3228.2
Trapped Outside Tanks	5.6	7.8
Tanked	2008.6	3220.4
Trapped Inside Tanks	9.1	26.4
Nominal Deliverable	1999.5	3194.1
Outage	TBD	TBD
Total APS Propellant	TBD	

The following table should be used to determine the amount of propellant to be off-loaded from a full condition to arrive at the indicated load. The allowable tolerance for the calculated off-load is ± 0.5 pounds per weigh tank.

A. Final tank pressure at overfill (PSIG)	49.3	51.9
B. Propellant loading temperature ($^{\circ}$ F)	69.2	67.4
C. Nominal overfill quantity (lb)	2074.1	3317.7
D. Correction for tank pressure (lb)	0.8	1.8
Δ Fuel = 0.09 (Item A-40)		
Δ Oxidizer = 0.15 (Item A-40)		
¹ E. Correction for loading temperature (lb)		
Δ Fuel = -1.16 (Item B-65)	-4.9	-6.8
Δ Oxidizer = -2.84 (Item B-65)		
² F. Measured density (GM/CC)	0.8992	1.4817
² G. Nominal density (GM/CC)	0.8994	1.4824
H. Delta density (GM/CC) (Item F-G)	-0.0002	-0.0007
³ I. Correction for measured density		
Δ Fuel = 2300 (Item H)	-0.5	-1.6
Δ Oxidizer = 2300 (Item H)		
J. Propellant in GSE	1.6	4.8
K. Overfill quantity (C+D+E+I+J)	2071.1	3315.9
L. Target loading	2014.4	3228.2
M. Quantity required to fill RCS manifolds	7.9	12.7
N. Quantity to be off-loaded (Items K-L-M)	48.8	75.0

NOTES:

¹Loading temperature correction will always be negative.

²To calculate the nominal density solve the following equation where T-temperature in $^{\circ}$ C of the measured density (usually 4° C for oxidizer and 25° C for fuel). This equation is valid for 14.7 PSIA. Therefore, the measured density must also be at 14.7 PSIA.

Nominal fuel density = $0.922904 - 0.0009377 (^{\circ}$ C)

Nominal oxidizer density = $1.491539 - 0.0022832 (^{\circ}$ C)

³Correction for measured density may be either positive or negative.

M M M E E E L L L E E E L L L H H H A A A

TABLE 3.3-16 (Continued)
LM-7 Consumable Loading Requirements
LM-7 DPS Propellant

	<u>Fuel (lb)</u>	<u>Oxidizer (lb)</u>
Propellant Load	<u>7083.6</u>	<u>11350.9</u>
Trapped Outside Tanks	<u>35.1</u>	<u>60.5</u>
Tanked	<u>7048.5</u>	<u>11290.4</u>
Trapped Inside Tanks	<u>21.7</u>	<u>62.7</u>
Nominal Deliverable	<u>7026.8</u>	<u>11227.7</u>
Outage	<u>TBD</u>	<u>TBD</u>
Total DPS Propellant Available	<u>TBD</u>	<u>TBD</u>

The following table should be used to determine the amount of propellant to be off-loaded from a full condition to arrive at the indicated load. The allowable tolerance for the calculated off-load is ± 0.5 pounds per weigh tank.

A1. Final tank pressure at overfill (PSIG)	<u>41.8</u>	<u>53.6</u>
B1. Propellant loading temperature ($^{\circ}$ F)	<u>69.96</u>	<u>67.7</u>
C1. Nominal overfill quantity (lb)	<u>7159.1</u>	<u>11462.3</u>
D1. Correction for tank pressure (lb)	<u>0.6</u>	<u>6.9</u>
Δ Fuel = 0.31 (Item A1-40)		
Δ Oxidizer = 0.51 (Item A1-40)		
¹ E1. Correction for loading temperature (lb)	<u>-19.8</u>	<u>-26.6</u>
Δ Fuel = -4.0 (Item B1-65)		
Δ Oxidizer = -9.85 (Item B1-65)		
² F1. Measured density (GM/CC)	<u>0.8992</u>	<u>1.4817</u>
² G1. Nominal density (GM/CC)	<u>0.8994</u>	<u>1.4824</u>
H1. Delta density (GM/CC) (Item F1-Item G1)	<u>-0.0002</u>	<u>-0.0007</u>
³ I1. Correction for measured density	<u>-1.6</u>	<u>-5.5</u>
Δ Fuel = 7900 (Item H1)		
Δ Oxidizer = 7900 (Item H1)		
J1. Propellant in GSE	<u>2.3</u>	<u>3.8</u>
K1. Overfill quantity (C1+D1+E1+I1+J1)	<u>7140.6</u>	<u>11440.9</u>
L1. Target loading	<u>7083.7</u>	<u>11351.1</u>
M1. Quantity required to fill RCS manifolds (APS only)	<u>XXXXXX</u>	<u>XXXXXX</u>
N1. Quantity to be off-loaded (Items K1-L1-M1)	<u>56.8</u>	<u>89.8</u>

NOTES:

¹Loading temperature correction will always be negative.

²To calculate the nominal density solve the following equation where T=temperature in $^{\circ}$ C of the measured density (usually 4° C for oxidizer and 25° C for fuel). This equation is valid for 14.7 PSIA. Therefore, the measured density must also be at 14.7 PSIA.

$$\text{Nominal fuel density} = 0.922904 - 0.0009377 (^{\circ}\text{C})$$

$$\text{Nominal oxidizer density} = 1.491539 - 0.0022832 (^{\circ}\text{C})$$

³Correction for measured density may be either positive or negative

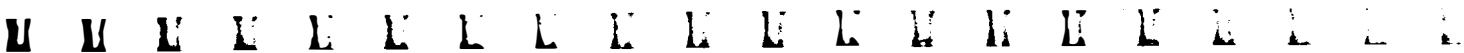

TABLE 3.3-16 (Continued)
LM-7 - RCS Propellant ⁽²⁾ ⁽³⁾

	Required	Ullage Requirement (in ³)		¹ Actual ⁵	¹ Actual ⁶
	Load (lb) ⁵	Minimum ⁴	Maximum ⁴	Load (lb)	Ullage (in ³)
System A Fuel	107.7±0.9	111.0	123.0	107.7	132.0
System A Oxidizer	208.8±1.9	225.5	237.5	208.8	205.7
System B Fuel	107.7±0.9	111.0	123.0	107.7	134.0
System B Oxidizer	208.8±1.9	225.5	237.5	208.8	219.0

	FUEL	OXIDIZER
Propellant Load	215.4	417.6
Trapped Outside Tanks	10.8	17.6
Tanked	204.6	400.0
Trapped in Tanks	4.2	8.0
Nominal Deliverable	200.4	392.0

LM-7 - Helium & Nitrogen

Consumable	Nominal Loading Requirement			Actual		
	Pressure (PSIA)	Temp (°F)	Weight (lb)	Pressure (PSIA)	Temp (°F)	Weight (lb)
Helium - APS tank #1 (6)	3050	70°	6.6	3115	75.0	
- APS tank #2 (6)	3050	70°	6.6	3203	76.4	
- RCS tank #1 (6)	3050	70°	1.05	3126	82.3	
- RCS tank #2 (6)	3050	70°	1.05	3099	81.1	
- DPS (SHe)	80±2	N/A	48.5	-	-	
- DPS (Ambient)(6)	1600	70°	1.1	1653	78.3	
Nitrogen - Ascent			0.1	N/A	N/A	
- Descent			0.6	N/A	N/A	

LM-7-Water & GOX

Consumable	Nominal Loading Requirement		Actual	
	Pressure (PSIA)	Weight (lb)	Pressure (PSIA)	Weight (lb)
Ascent Water - tank #1	N/A	42.5	N/A (99.6%)	42.3
- tank #2	N/A	42.5	N/A (99.2)	42.1
Descent Water	N/A	(7)	N/A (99.6)	264*
Ascent GOX - tank #1 (6)	830	2.4	841 (72°F)	-
- tank #2 (6)	830	2.4	838 (72°F)	-
Descent GOX (6)	2700	48.0	2776 (80°F)	-

*As serviced, predicted at lift-off is 254 lb.

NOTES:

- ¹ See Table 3.3-17 for actual propellant load calculation.
- ² See Section 5.6 for explanation of trapped propellants.
- ³ See Table 3.3-18 for loading uncertainties.
- ⁴ PV ullage calculation should be 125±50 cubic inches for LM/RCS fuel and 238.5±50 cubic inches for LM/RCS oxidizer per tank.
- ⁵ LM/RCS required load includes propellant required to fill RCS manifolds to isolation valves. See Table 3.3-16. See Section 5.6 for trapped propellants.
- ⁶ The indicated items should be loaded in accordance with loading windows contained in the CSM/LM Spacecraft Operational Data Book, Volume II, Part 2, SNA-8-D-027PT2.
- ⁷ LM-7 Descent Water load at Earth Launch shall be 250 -0, +10 pounds. The initial load will be determined by sampling requirements.

U U U E E E L E E E E U U U E E L L L

TABLE 3.3-17

LOAD CALCULATION

<u>APS PROPELLANT</u>		<u>Fuel</u>	<u>Oxidizer</u>
1.	Full tank - Item K, Table 3.3-16 (1b)	<u>2071.1</u>	<u>3315.9</u>
¹ 2.	Density of off-load tables at loading temperature and pressure (lb/ft ³)	<u>N/A</u>	<u>N/A</u>
¹ 3.	Propellant volume (divide item 1 by item 2. (ft ³))	<u>N/A</u>	<u>N/A</u>
¹ 4.	Measured density (from Table 3.3-19) (lb/ft ³)	<u>N/A</u>	<u>N/A</u>
5.	Resulting full tank load (lb)	<u>2071.1</u>	<u>3315.9</u>
6.	Off-load amount (lb)	<u>49.0</u>	<u>75.0</u>
7.	Propellant required to fill RCS manifolds (lb)	<u>7.9</u>	<u>12.7</u>
8.	Propellant load (lb)	<u>2014.2</u>	<u>3228.2</u>
<u>DPS PROPELLANT</u>			
9.	Full tank - Item K1 Table 3.3-16 (1b)	<u>7140.6</u>	<u>11441.9</u>
¹ 10.	Density of off-load tables at loading temperature and pressure (lb/ft ³)	<u>N/A</u>	<u>N/A</u>
¹ 11.	Propellant volume (divide Item 9 by Item 10)(ft ³)	<u>N/A</u>	<u>N/A</u>
¹ 12.	Measured density (from Table 3.3-19) (lb/ft ³)	<u>N/A</u>	<u>N/A</u>
13.	Resulting full tank load (lb)	<u>7140.6</u>	<u>11440.9</u>
14.	Off-load amount (lb)	<u>57.0</u>	<u>90.0</u>
15.	Propellant load (lb)	<u>7083.6</u>	<u>11350.9</u>

RCS PROPELLANT

P. V. Calculations

	<u>Fuel</u>		<u>Oxidizer</u>	
	<u>Tank A</u>	<u>Tank B</u>	<u>Tank A</u>	<u>Tank B</u>
A. GSE Volume (in ³)	<u>18.45</u>	<u>37.4</u>	<u>17.94</u>	<u>30.25</u>
B. Initial Ullage Pressure (PSIG)	<u>33.7</u>	<u>33.4</u>	<u>34.9</u>	<u>34.6</u>
C. Initial GSE Pressure (PSIG)	<u>1.0</u>	<u>0.5</u>	<u>0.0</u>	<u>0.0</u>
D. Final GSE - S/C Pressure (PSIG)	<u>29.7</u>	<u>26.2</u>	<u>32.1</u>	<u>30.4</u>
E. Ullage Volume (in ³) - Solve the following equation by substituting the values in the indicated steps.	<u>132</u>	<u>134</u>	<u>205.7</u>	<u>219.01</u>
Ullage Volume = $\frac{(D-C)(A)}{B-D}$				

NOTE: ¹These items will be completed only if a density sample is not made prior to loading. If a density sample is made prior to loading, then the items will be left blank.



TABLE 3.3-18
LM-7 Propellant Loading Uncertainties

	<u>Fuel (lb)</u>	<u>Oxidizer (lb)</u>
Vent line Volume	<u>±0.2</u>	<u>±0.3</u>
Tank Volume	<u>±0.8</u>	<u>±1.3</u>
Pressure Measurement (±5 PSIA)	<u>±0.5</u>	<u>±0.8</u>
Temperature Measurement (±1.5°F)	<u>±1.7</u>	<u>±4.3</u>
Measured Density	<u>±0.7</u>	<u>±0.5</u>
² Weight Measurement	<u>±0.5</u>	<u>±0.5</u>
¹ Loading Tolerance	<u>±0.0</u>	<u>±0.0</u>
Total Loading Uncertainty	<u>±4.4</u>	<u>±7.7</u>

APS Mission Uncertainties	
Mixture Ratio Variation	-34.6
$\Delta V, I_{sp}$, Vehicle Weight Variation	-54.0
Propellant Usage Uncertainty Due To Total Loading Uncertainty	-9.7
Total Propellant Uncertainty For Mission ΔV	-64.9

LM-7 DPS PROPELLANT		
Vent Line Volume	<u>±0.2</u>	<u>±0.3</u>
Tank Volume	<u>±3.4</u>	<u>±5.6</u>
Pressure Measurement (±5 PSIA)	<u>±1.6</u>	<u>±2.6</u>
Temperature Measurement (1.5°F)	<u>±6.1</u>	<u>±14.8</u>
Measured Density	<u>±2.4</u>	<u>±1.6</u>
² Weight Measurement	<u>±0.5</u>	<u>±0.5</u>
¹ Loading Tolerance	<u>±0.0</u>	<u>±0.0</u>
Total Loading Uncertainty	<u>±14.2</u>	<u>±25.4</u>

DPS Mission Uncertainties	
Mixture Ratio Variation	-115.7
$\Delta V, I_{sp}$, Vehicle Weight Variation	-341.2
Propellant Usage Uncertainty Due to Total Loading Uncertainty	-29.3
Total Propellant Uncertainty For Mission ΔV	-361.5

LM-7 RCS PROPELLANT		
Loading Temperature	<u>±0.6</u>	<u>±1.8</u>
Ullage Calculation	<u>±0.4</u>	<u>±0.6</u>
Tank and Manifold Volume	<u>±0.8</u>	<u>±1.4</u>
Total	<u>±1.8</u>	<u>±3.8</u>

¹These will be known quantities after loading is accomplished.
²If weigh tank is used for off-loading, then weight measurement uncertainty is ±0.5 pounds per weigh tank. If flow meter is used for off-loading, then weight measurement uncertainty is ±4.0% of amount off-loaded.



TABLE 3.3-19

LM-7 APS Propellant Loading Parameters
(To Be Completed by KSC at Loading)

	<u>Fuel</u>	<u>Oxidizer</u>
Loading Pressure - PSIA	<u>64.0</u>	<u>66.6</u>
Loading Temperature - Fill Line - Degrees F $\left\{ \begin{array}{l} \text{TT 58 Fuel} \\ \text{TT258 Oxidizer} \end{array} \right.$	<u>69.1</u>	<u>66.8</u>
Loading Temperature - Return Line - Degrees F $\left\{ \begin{array}{l} \text{TT 59 Fuel} \\ \text{TT259 Oxidizer} \end{array} \right.$	<u>69.3</u>	<u>68.0</u>
Loading Temperature - Tank - Degrees F $\left\{ \begin{array}{l} \text{GP0718 Fuel} \\ \text{GP1218 Oxidizer} \end{array} \right.$	<u>68.2</u>	<u>67.7</u>
Number of Times Weigh Tank Used (Flow Meter Not Used)	<u>1</u>	<u>1</u>
Total Pounds Off-Loaded Using Weigh Tank (Flow Meter Not Used)	<u>49.0</u>	<u>75.0</u>
Pounds Off-Loaded Using Flow Meter (Weigh Tank Not Used)	<u>N/A</u>	<u>N/A</u>
Measured Fuel Density @2°C; @ 14.7 PSIA GM/CC	<u>0.8992</u>	<u>-</u>
Measured Oxidizer Density @4°C; @ 14.7 PSIA GM/CC	<u>-</u>	<u>1.4817</u>



TABLE 3.3-19 (Continued)

LM-7 DPS Propellant Loading Parameters

	<u>Fuel</u>	<u>Oxidizer</u>
Loading Pressure - PSIA	<u>56.5</u>	<u>68.3</u>
Loading Temperature - Fill Line - Degrees F	<u>69.6</u>	<u>67.7</u>
	TT 58 Fuel	TT258 Oxidizer
Loading Temperature - Return Line - Degrees F	<u>70.3</u>	<u>67.7</u>
	TT 59 Fuel	TT259 Oxidizer
Loading Temperature - Tank One - Degrees F	<u>69.3</u>	<u>67.8</u>
	GQ3718 Fuel	GQ4218 Oxidizer
Loading Temperature - Tank Two - Degrees F	<u>69.7</u>	<u>67.4</u>
	GQ3719 Fuel	GQ4219 Oxidizer
Number of Times Weigh Tank Used (Flow Meter Not Used)	<u>1</u>	<u>1</u>
Total Pounds Off-Loaded Using Weigh Tank (Flow Meter Not Used)	<u>57.0</u>	<u>90.0</u>
Pounds Off-Loaded Using Flow Meter (Weigh Tank Not Used)	<u>N/A</u>	<u>N/A</u>
Measured Fuel Density @ 25°C; 14.7 PSIA GM/CC	<u>0.8992</u>	<u>-</u>
Measured Oxidizer Density @ 4°C; 14.7 PSIA GM/CC	<u>-</u>	<u>1.4817</u>

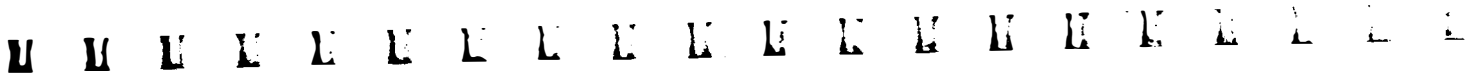

MISSION H-2 MASS PROPERTY DATA TABLES

Unless otherwise stated, the controlling vehicle propellants are in the low end of their tanks and the passive vehicle propellants are in the high end of their tanks.

- Table 3.3-20 presents CSM-109/LM-7 (docked) mass properties, in Apollo coordinates, as a function of spacecraft weight for the Hybrid SM/SPS burn.
- Table 3.3-21 presents the CSM-109/LM-7 (docked) mass properties, in Apollo coordinates, as a function of spacecraft weight for L.O.I. SM/SPS burn.
- Table 3.3-22 presents the CSM-109/LM-7 (docked) mass properties, in Apollo coordinates as a function of spacecraft weight for the D.O.I. SM/SPS burn.
- Table 3.3-23 presents the CSM-109 mass properties, in Apollo coordinates, as a function of CSM weight for the Circularization I SM/SPS burn.
- Table 3.3-24 presents the CSM-109 mass properties, in Apollo coordinates, as a function of CSM weight for the Plane Change I SM/SPS burn.
- Table 3.3-25 presents the CSM-109 mass properties, in Apollo coordinates, as a function of CSM weight for the Plane Change II SM/SPS burn.
- Table 3.3-26 presents the CSM-109 mass properties, in Apollo coordinates, as a function of CSM weight for the T.E.I. SM/SPS burn.
- Table 3.3-27 presents the LM-7 mass properties, in LM coordinates, as a function of LM weight for the P.D.I. DPS burn.
- Table 3.3-28 presents the LM-7 ascent stage mass properties, in LM coordinates as a function of weight for the lunar liftoff APS burn.
- Table 3.3-29 presents the LM-7 mass properties, in LM coordinates, as a function of LM weight for the C.S.I. to docking LM/RCS burn.



X(A) COORDINATES

TABLE 3.3-20

CSM-109/LM-7 HYBRID BURN

WEIGHT LBS.	X-BAR	Y-BAR INCHES	Z-BAR	IXX	IYY	IZZ SLUG-FT SQ	PXY	PXZ	PYZ	PITCH DEGREES	YAW DEGREES	AVERAGE MOMENT	INERTIA/THRUST RATIO
97098.6	1038.93	2.57	4.33	56661	535515	538631	-8357	-9242	3526	.945	-.235	537073	1.482
97078.6	1038.94	2.57	4.32	56651	535484	538610	-8357	-9240	3523	.946	-.235	537047	1.482
97058.6	1038.96	2.57	4.32	56640	535454	538588	-8357	-9238	3520	.946	-.235	537021	1.482
97038.6	1038.97	2.57	4.32	56630	535424	538566	-8356	-9236	3517	.947	-.235	536995	1.482
97018.6	1038.99	2.57	4.32	56619	535393	538544	-8356	-9234	3514	.947	-.235	536969	1.482
96998.6	1039.00	2.57	4.32	56609	535362	538522	-8356	-9232	3511	.948	-.236	536942	1.481
96978.6	1039.01	2.57	4.32	56598	535332	538500	-8356	-9230	3509	.948	-.236	536916	1.481
96958.6	1039.03	2.57	4.32	56588	535301	538478	-8355	-9228	3506	.949	-.236	536889	1.481
96938.6	1039.04	2.57	4.32	56578	535270	538456	-8355	-9226	3503	.949	-.236	536863	1.481
96918.6	1039.06	2.57	4.31	56567	535239	538433	-8355	-9223	3500	.950	-.236	536836	1.481
96898.6	1039.07	2.57	4.31	56557	535207	538411	-8355	-9221	3497	.950	-.236	536809	1.481
96878.6	1039.09	2.57	4.31	56546	535176	538388	-8354	-9219	3494	.951	-.236	536782	1.480
96858.6	1039.10	2.57	4.31	56536	535145	538365	-8354	-9217	3491	.951	-.236	536755	1.480
96838.6	1039.12	2.57	4.31	56525	535113	538342	-8354	-9215	3488	.951	-.236	536728	1.480
96818.6	1039.13	2.56	4.31	56515	535082	538319	-8354	-9213	3485	.952	-.236	536700	1.480
96798.6	1039.15	2.56	4.31	56505	535050	538296	-8353	-9211	3482	.952	-.237	536673	1.480
96778.6	1039.16	2.56	4.30	56494	535018	538273	-8353	-9209	3479	.953	-.237	536646	1.479
96758.6	1039.18	2.56	4.30	56484	534986	538250	-8353	-9207	3476	.953	-.237	536618	1.479
96738.6	1039.19	2.56	4.30	56473	534954	538226	-8353	-9205	3474	.954	-.237	536590	1.479
96718.6	1039.21	2.56	4.30	56463	534922	538203	-8352	-9203	3471	.954	-.237	536562	1.479
96698.6	1039.22	2.56	4.30	56452	534890	538179	-8352	-9201	3468	.955	-.237	536534	1.479
96678.6	1039.24	2.56	4.30	56442	534857	538155	-8352	-9198	3465	.955	-.237	536506	1.479
96658.6	1039.25	2.56	4.30	56432	534825	538132	-8351	-9196	3462	.956	-.237	536478	1.478
96638.6	1039.27	2.56	4.29	56421	534792	538108	-8351	-9194	3459	.956	-.237	536450	1.478
96618.6	1039.28	2.56	4.29	56411	534759	538084	-8351	-9192	3456	.957	-.237	536421	1.478
96598.6	1039.30	2.56	4.29	56400	534727	538059	-8351	-9190	3453	.957	-.238	536393	1.478
96578.6	1039.32	2.56	4.29	56390	534694	538035	-8350	-9188	3450	.958	-.238	536364	1.478
96558.6	1039.33	2.56	4.29	56379	534661	538011	-8350	-9186	3447	.958	-.238	536336	1.477
96538.6	1039.35	2.56	4.29	56369	534627	537986	-8350	-9184	3444	.959	-.238	536307	1.477
96518.6	1039.36	2.56	4.29	56358	534594	537962	-8350	-9181	3442	.959	-.238	536278	1.477
96498.6	1039.38	2.56	4.28	56348	534561	537937	-8349	-9179	3439	.960	-.238	536249	1.477
96478.6	1039.39	2.56	4.28	56338	534527	537912	-8349	-9177	3436	.960	-.238	536220	1.477
96458.6	1039.41	2.56	4.28	56327	534494	537887	-8349	-9175	3433	.960	-.238	536190	1.476
96438.6	1039.42	2.56	4.28	56317	534460	537862	-8349	-9173	3430	.961	-.238	536161	1.476
96418.6	1039.44	2.55	4.28	56306	534426	537837	-8348	-9171	3427	.961	-.238	536131	1.476
96398.6	1039.46	2.56	4.28	56296	534392	537811	-8348	-9169	3424	.962	-.239	536102	1.476
96378.6	1039.47	2.56	4.28	56285	534358	537786	-8348	-9166	3421	.962	-.239	536072	1.476

SNA-8-D-027(III)REV 2

(A) COORDINATES

TABLE 3.3-21

CSM-109/LM-7 L.O.I. BUPN

HEIGHT LBS.	X-BAF	Y-BAF INCHES	Z-BAF	IXX	IYY	IZZ SLUG-FT SQ	PXY	PXZ	PYZ	PITCH DEGREES	YAW	AVERAGE MOMENT	INERTIA/THRUST RATIO
97041.0	1039.02	2.57	4.28	56615	535137	539240	-8485	-9207	3575	.960	-.234	536689	1.481
96641.0	1039.31	2.57	4.25	56406	534519	537795	-8480	-9166	3516	.970	-.236	536157	1.477
96241.0	1039.62	2.57	4.22	56197	533957	537306	-8475	-9122	3458	.979	-.238	535592	1.473
95941.0	1039.95	2.56	4.19	55988	533151	536772	-8469	-9077	3400	.989	-.240	534961	1.469
95441.0	1040.29	2.56	4.16	55780	532397	536191	-8463	-9029	3341	.999	-.242	534294	1.465
95041.0	1040.65	2.55	4.13	55571	531595	535561	-8457	-8979	3283	1.009	-.244	533578	1.460
94641.0	1041.02	2.55	4.10	55362	530742	534881	-8451	-8927	3225	1.019	-.246	532812	1.456
94241.0	1041.40	2.55	4.07	55153	529936	534149	-8444	-8873	3166	1.029	-.249	531993	1.451
93841.0	1041.81	2.54	4.04	54944	528877	533362	-8437	-8816	3108	1.039	-.251	531120	1.446
93441.0	1042.23	2.54	4.01	54735	527861	532519	-8430	-8758	3050	1.050	-.253	530190	1.440
93041.0	1042.66	2.54	3.98	54526	526797	531618	-8422	-8696	2991	1.060	-.256	529202	1.435
92641.0	1043.12	2.53	3.95	54317	525652	530657	-8415	-8633	2933	1.071	-.259	528154	1.429
92241.0	1043.58	2.53	3.92	54108	524455	529633	-8406	-8567	2874	1.082	-.261	527044	1.422
91841.0	1044.07	2.53	3.89	53899	523193	528544	-8398	-8498	2816	1.092	-.264	525869	1.416
91441.0	1044.57	2.52	3.86	53690	521864	527389	-8389	-8428	2758	1.103	-.266	524627	1.409
91041.0	1045.09	2.52	3.83	53481	520466	526164	-8380	-8354	2699	1.115	-.269	523315	1.402
90641.0	1045.63	2.51	3.80	53272	518997	524868	-8371	-8278	2641	1.126	-.272	521932	1.395
90241.0	1046.19	2.51	3.77	53062	517454	523498	-8361	-8200	2583	1.137	-.275	520476	1.388
89841.0	1046.76	2.51	3.73	52853	515834	522051	-8351	-8119	2524	1.148	-.278	518943	1.380
89441.0	1047.35	2.50	3.70	52644	514135	520526	-8341	-8036	2466	1.160	-.281	517331	1.372
89041.0	1047.95	2.50	3.67	52434	512355	518919	-8330	-7950	2407	1.171	-.284	515637	1.363
88641.0	1048.59	2.49	3.63	52225	510491	517229	-8319	-7861	2349	1.183	-.287	513860	1.355
88241.0	1049.24	2.49	3.60	52015	508540	515451	-8308	-7769	2291	1.195	-.290	511995	1.346
87841.0	1049.91	2.49	3.57	51806	506499	513584	-8296	-7675	2232	1.207	-.293	510041	1.336
87441.0	1050.59	2.48	3.53	51596	504365	511624	-8284	-7578	2174	1.219	-.296	507995	1.327
87041.0	1051.30	2.48	3.50	51387	502137	509569	-8271	-7478	2115	1.231	-.299	505853	1.317
86641.0	1052.03	2.47	3.46	51177	499909	507415	-8259	-7376	2057	1.243	-.303	503612	1.307
86241.0	1052.77	2.47	3.43	50967	497381	505161	-8245	-7270	1998	1.255	-.306	501271	1.296
85841.0	1053.54	2.46	3.39	50758	494848	502801	-8232	-7161	1940	1.268	-.309	498824	1.285
85441.0	1054.33	2.46	3.36	50548	492207	500324	-8218	-7050	1881	1.280	-.313	496270	1.274
85041.0	1055.14	2.45	3.32	50338	489455	497756	-8204	-6935	1823	1.293	-.316	493605	1.263
84641.0	1055.97	2.45	3.29	50128	486588	495063	-8189	-6819	1765	1.305	-.320	490826	1.251
84241.0	1056.82	2.45	3.25	49918	483604	492253	-8174	-6697	1706	1.318	-.323	487929	1.239
83841.0	1057.70	2.44	3.21	49708	480498	489321	-8159	-6573	1648	1.330	-.327	484910	1.226
83441.0	1058.60	2.44	3.17	49498	477268	486265	-8143	-6446	1589	1.343	-.331	481766	1.214
83041.0	1059.52	2.43	3.14	49288	473908	483080	-8126	-6315	1531	1.356	-.334	478494	1.200
82641.0	1060.45	2.43	3.10	49078	470417	479762	-8110	-6181	1472	1.369	-.338	475089	1.187

U
R
I
T
A
N
T
I
E
S

Amendment 79
3/30/70

X(A) COORDINATES

TABLE 3.3-21 (CONTINUED)

CSM-109/LM-7 L.O.I. BURN

WEIGHT LBS.	X-BAR	Y-BAR INCHES	Z-BAR	IXX	IYY	IZZ SLUG-FY SQ	PXY	PXZ	PLY	PITCH DEGREES	YAW DEGREES	AVERAGE MOMENT	INERTIA/THRUST RATIO
82241.0	1061.43	2.42	3.06	48868	466813	476333	-8093	-6047	1414	1.382	-.342	471573	1.173
81841.0	1062.43	2.42	3.02	48557	463013	472707	-8075	-5904	1355	1.395	-.346	467860	1.159
81441.0	1063.44	2.41	2.98	48447	459134	469002	-8057	-5761	1297	1.408	-.350	464068	1.144
81041.0	1064.44	2.41	2.94	48237	455096	465139	-8039	-5613	1238	1.421	-.354	460118	1.130
80641.0	1065.54	2.40	2.90	48026	450881	461098	-8020	-5462	1180	1.435	-.358	455990	1.114
80241.0	1066.54	2.40	2.86	47816	446506	456898	-8001	-5307	1121	1.448	-.362	451702	1.099
79841.0	1067.76	2.39	2.82	47605	441967	452533	-7981	-5148	1062	1.461	-.366	447250	1.083
79441.0	1068.88	2.38	2.78	47395	437374	448097	-7956	-5009	1005	1.473	-.371	442735	1.067
79041.0	1069.36	2.34	2.79	47134	436639	447169	-7886	-5020	980	1.473	-.383	441904	1.062
78641.0	1069.86	2.29	2.80	46993	435836	446173	-7813	-5030	955	1.473	-.395	441004	1.058
78241.0	1070.37	2.25	2.80	46792	434567	445109	-7737	-5042	930	1.473	-.407	440038	1.053
77841.0	1070.91	2.20	2.81	46590	434031	443980	-7657	-5054	905	1.473	-.419	439005	1.049
77441.0	1071.47	2.16	2.82	46399	433031	442785	-7574	-5066	880	1.473	-.432	437908	1.044
77041.0	1072.04	2.11	2.82	46198	431966	441527	-7488	-5078	855	1.473	-.444	436746	1.038
76641.0	1072.64	2.06	2.83	45996	430837	440204	-7399	-5091	830	1.473	-.457	435520	1.033
76241.0	1073.25	2.01	2.84	45794	429644	438817	-7308	-5105	805	1.473	-.469	434231	1.027
75841.0	1073.80	1.97	2.84	45593	428388	437366	-7213	-5119	780	1.473	-.482	432877	1.021
75441.0	1074.54	1.92	2.85	45391	427067	435851	-7115	-5133	755	1.473	-.495	431459	1.015
75041.0	1075.22	1.87	2.86	45179	425682	434272	-7014	-5147	730	1.473	-.508	429977	1.009
74641.0	1075.91	1.82	2.87	44977	424231	432627	-6911	-5162	705	1.474	-.521	428429	1.002
74241.0	1076.62	1.77	2.87	44776	422715	430915	-6804	-5178	680	1.474	-.534	426815	.996
73841.0	1077.35	1.72	2.88	44573	421131	429137	-6695	-5194	655	1.474	-.547	425134	.989
73441.0	1078.10	1.67	2.89	44371	419478	427290	-6582	-5210	630	1.474	-.560	423384	.982
73041.0	1078.88	1.61	2.89	44169	417755	425372	-6467	-5227	605	1.475	-.574	421564	.974
72641.0	1079.67	1.56	2.90	43967	415961	423383	-6348	-5244	580	1.475	-.587	419672	.967
72241.0	1080.48	1.51	2.91	43764	414093	421320	-6226	-5262	555	1.476	-.600	417706	.959
71841.0	1081.32	1.45	2.92	43562	412148	419180	-6101	-5280	530	1.476	-.614	415664	.951
71441.0	1082.17	1.40	2.93	43359	410126	416963	-5973	-5298	506	1.477	-.628	413544	.943
71041.0	1083.05	1.35	2.93	43157	408023	414665	-5842	-5317	481	1.477	-.641	411344	.935
70641.0	1083.95	1.29	2.94	42954	405837	412283	-5707	-5337	456	1.478	-.655	409060	.926
70241.0	1084.89	1.23	2.95	42751	403564	409815	-5569	-5357	431	1.479	-.669	406690	.918
69841.0	1085.82	1.19	2.96	42548	401203	407258	-5427	-5378	406	1.479	-.683	404231	.909
69441.0	1086.79	1.12	2.97	42345	398749	404609	-5282	-5399	381	1.480	-.697	401679	.899
69041.0	1087.79	1.06	2.97	42142	396201	401865	-5133	-5420	357	1.481	-.711	399033	.890
68641.0	1088.81	1.00	2.98	41939	393553	399022	-4980	-5442	332	1.481	-.725	396287	.880
68241.0	1089.85	.94	2.99	41735	390803	396076	-4824	-5465	307	1.482	-.739	393440	.870
67841.0	1090.92	.88	3.00	41532	387948	393025	-4663	-5488	282	1.483	-.754	390486	.860

SNA-B-D-027(III)REV 2

X(A) COORDINATES

TABLE 3.3-22

CSM-109/LM7 D.O.I. BURN

WEIGHT LBS.	X-BAR	Y-BAR INCHES	Z-BAR	IXX	IYY	IZZ SLUG-FT SQ	PXY	PXZ	PYZ	PITCH DEGREES	YAW	AVERAGE MOMENT	INERTIA/THRUST RATIO
74360.0	1076.40	1.79	2.87	44907	423082	431378	-6864	-5162	705	1.474	-.528	427230	.997
74260.0	1076.58	1.78	2.97	44757	422699	430947	-6838	-5166	699	1.474	-.531	426823	.996
74160.0	1076.76	1.77	2.87	44706	422312	430511	-6811	-5170	693	1.474	-.534	426412	.994
74060.0	1076.94	1.76	2.87	44656	421921	430072	-6784	-5174	687	1.474	-.537	425996	.992
73960.0	1077.13	1.74	2.88	44605	421525	429628	-6756	-5178	680	1.474	-.541	425577	.991
73860.0	1077.31	1.73	2.88	44555	421126	429179	-6729	-5182	674	1.474	-.544	425153	.989
73760.0	1077.49	1.72	2.88	44504	420723	428727	-6701	-5186	668	1.475	-.547	424725	.987
73660.0	1077.68	1.70	2.88	44454	420314	428270	-6673	-5190	662	1.475	-.551	424292	.985
73560.0	1077.87	1.69	2.89	44403	419902	427809	-6645	-5194	655	1.475	-.554	423855	.984
73460.0	1078.06	1.68	2.89	44353	419485	427343	-6617	-5198	649	1.475	-.557	423414	.982
73360.0	1078.25	1.67	2.89	44302	419064	426874	-6588	-5202	643	1.475	-.561	422969	.980
73260.0	1078.44	1.65	2.89	44252	418638	426399	-6560	-5206	637	1.475	-.564	422519	.978
73160.0	1078.63	1.64	2.89	44201	418208	425921	-6531	-5210	630	1.475	-.567	422065	.976
73060.0	1078.83	1.63	2.89	44150	417774	425438	-6502	-5215	624	1.475	-.571	421606	.975
72960.0	1079.02	1.61	2.90	44100	417335	424950	-6472	-5219	618	1.475	-.574	421142	.973
72860.0	1079.22	1.60	2.90	44049	416892	424458	-6443	-5223	612	1.475	-.577	420675	.971
72760.0	1079.42	1.59	2.90	43999	416444	423961	-6413	-5227	605	1.475	-.581	420202	.969
72660.0	1079.62	1.57	2.90	43948	415991	423460	-6384	-5232	599	1.476	-.584	419726	.967
72560.0	1079.82	1.56	2.90	43898	415534	422954	-6354	-5236	593	1.476	-.587	419244	.965
72460.0	1080.02	1.55	2.90	43847	415072	422444	-6323	-5241	587	1.476	-.591	418758	.963
72360.0	1080.22	1.53	2.91	43796	414606	421929	-6293	-5245	581	1.476	-.594	418267	.961
72260.0	1080.43	1.52	2.91	43746	414135	421409	-6262	-5249	574	1.476	-.597	417772	.959
72160.0	1080.63	1.51	2.91	43695	413659	420884	-6232	-5254	568	1.476	-.601	417272	.958
72060.0	1080.84	1.49	2.91	43645	413179	420355	-6201	-5258	562	1.476	-.604	416767	.956
71960.0	1081.05	1.48	2.91	43594	412693	419821	-6169	-5263	556	1.476	-.608	416257	.954
71860.0	1081.25	1.47	2.92	43543	412203	419282	-6138	-5267	549	1.477	-.611	415743	.952
71760.0	1081.47	1.45	2.92	43493	411708	418738	-6106	-5272	543	1.477	-.614	415223	.950
71660.0	1081.68	1.44	2.92	43442	411208	418190	-6075	-5277	537	1.477	-.618	414699	.948
71560.0	1081.90	1.43	2.92	43391	410704	417636	-6043	-5281	531	1.477	-.621	414170	.946
71460.0	1082.11	1.41	2.92	43341	410194	417078	-6010	-5286	525	1.477	-.625	413636	.944
71360.0	1082.33	1.40	2.93	43290	409679	416514	-5978	-5291	518	1.477	-.628	413096	.942
71260.0	1082.55	1.39	2.93	43239	409159	415945	-5945	-5295	512	1.477	-.631	412552	.939
71160.0	1082.77	1.37	2.93	43189	408634	415371	-5913	-5300	506	1.477	-.635	412003	.937
71060.0	1082.99	1.36	2.93	43138	408104	414793	-5880	-5305	500	1.478	-.638	411448	.935
70960.0	1083.21	1.35	2.93	43087	407569	414208	-5846	-5310	493	1.478	-.642	410889	.933
70860.0	1083.43	1.33	2.94	43037	407028	413619	-5813	-5315	487	1.478	-.645	410324	.931
70760.0	1083.66	1.32	2.94	42986	406483	413025	-5779	-5319	481	1.478	-.649	409754	.929

X(A) COORDINATES

TABLE 3.3-23

CSM-109 CIRCULARIZATION BURN

WEIGHT LBS.	X-RAJ INCHES	Y-RAJ INCHES	Z-RAJ	IXX	IYY	IZZ SLUG-FT SQ	PXY	PXZ	PYZ	PITCH DEGREES	YAW	AVERAGE MOMENT	INERTIA/THRUST RATIO
37587.7	943.93	3.00	5.60	20842	56757	63446	-2089	907	338	-.747	.604	60101	.308
37937.7	943.84	2.95	5.60	20816	56756	63421	-2087	906	335	-.749	.598	60088	.308
37887.7	943.86	2.98	5.61	20791	56755	63396	-2086	906	332	-.752	.592	60075	.308
37837.7	943.88	2.97	5.61	20766	56753	63371	-2085	905	329	-.754	.586	60062	.309
37787.7	943.90	2.96	5.62	20741	56752	63346	-2084	904	326	-.756	.580	60049	.308
37737.7	943.91	2.95	5.63	20716	56751	63320	-2083	904	323	-.759	.575	60036	.308
37687.7	943.93	2.94	5.63	20691	56749	63295	-2082	903	321	-.761	.569	60022	.308
37637.7	943.95	2.92	5.64	20665	56748	63269	-2081	903	318	-.763	.563	60009	.308
37587.7	943.97	2.91	5.64	20640	56746	63244	-2079	902	315	-.766	.557	59995	.308
37537.7	943.99	2.90	5.65	20615	56745	63218	-2078	901	312	-.768	.551	59982	.307
37497.7	944.01	2.89	5.65	20590	56743	63193	-2077	901	309	-.770	.545	59968	.307
37437.7	944.03	2.89	5.66	20565	56741	63167	-2076	900	306	-.772	.539	59954	.307
37387.7	944.05	2.87	5.66	20539	56739	63141	-2074	899	303	-.775	.533	59940	.307
37337.7	944.07	2.86	5.67	20514	56737	63115	-2073	898	300	-.777	.527	59926	.307
37287.7	944.10	2.85	5.67	20489	56735	63089	-2071	898	297	-.779	.521	59912	.307
37237.7	944.12	2.84	5.68	20464	56733	63063	-2070	897	295	-.782	.515	59898	.307
37187.7	944.14	2.83	5.69	20438	56731	63037	-2069	896	292	-.784	.509	59884	.306
37137.7	944.16	2.81	5.69	20413	56729	63011	-2067	895	289	-.786	.503	59870	.306
37087.7	944.19	2.80	5.70	20388	56726	62984	-2066	895	286	-.788	.497	59855	.306
37037.7	944.21	2.79	5.70	20363	56724	62958	-2064	894	283	-.791	.491	59841	.306
36987.7	944.24	2.78	5.71	20338	56721	62931	-2062	893	280	-.793	.484	59826	.306
36937.7	944.26	2.77	5.71	20312	56718	62904	-2061	892	277	-.795	.478	59811	.306
36887.7	944.29	2.76	5.72	20287	56715	62878	-2059	891	274	-.797	.472	59797	.306
36837.7	944.31	2.75	5.73	20262	56713	62851	-2058	890	272	-.800	.466	59782	.305
36787.7	944.34	2.73	5.73	20237	56710	62824	-2056	890	269	-.802	.460	59767	.305
36737.7	944.37	2.72	5.74	20211	56706	62797	-2054	889	266	-.804	.453	59751	.305
36687.7	944.39	2.71	5.74	20186	56703	62769	-2052	888	263	-.806	.447	59736	.305
36637.7	944.42	2.70	5.75	20161	56700	62742	-2051	887	260	-.809	.441	59721	.305
35587.7	944.45	2.69	5.75	20136	55695	62715	-2049	886	257	-.811	.435	59705	.305
36537.7	944.48	2.68	5.76	20110	56692	62687	-2047	885	254	-.813	.428	59690	.305
36487.7	944.51	2.67	5.77	20085	56689	62659	-2045	884	251	-.815	.422	59674	.304
36437.7	944.54	2.65	5.77	20059	56685	62631	-2043	883	249	-.817	.416	59658	.304
36387.7	944.56	2.64	5.78	20035	56681	62603	-2041	882	246	-.820	.409	59642	.304

X-Y-Z COORDINATES

TABLE 3.3-24

CSM-109 PLANE CHANGE I

WEIGHT LBS.	X-PAF	Y-RAR INCHES	Z-PAR	IXY	IYY	IZZ SLUG-FT SQ	PXY	PXZ	PYZ	PITCH DEGREES	YAW	AVERAGE MOMENT	INERTIA/THRUST RATIO
37597.3	944.00	2.95	5.62	20601	56706	63263	-2083	911	338	-.755	.576	59984	.307
37547.3	944.01	2.94	5.63	20530	56704	63243	-2082	910	336	-.757	.571	59974	.307
37507.3	944.03	2.93	5.63	20540	56703	63223	-2081	910	333	-.759	.566	59963	.307
37467.3	944.05	2.92	5.64	20540	56702	63202	-2080	909	331	-.761	.561	59952	.307
37427.3	944.06	2.92	5.64	20520	56700	63182	-2079	909	329	-.763	.557	59941	.307
37387.3	944.08	2.91	5.64	20500	56699	63161	-2078	908	326	-.764	.552	59930	.307
37347.3	944.09	2.90	5.65	20480	56698	63141	-2077	908	324	-.766	.547	59919	.307
37307.3	944.11	2.89	5.65	20460	56696	63120	-2076	907	322	-.768	.542	59908	.307
37267.3	944.13	2.88	5.66	20439	56695	63099	-2075	906	319	-.770	.538	59897	.307
37227.3	944.15	2.87	5.66	20419	56693	63078	-2074	906	317	-.772	.533	59886	.306
37187.3	944.16	2.86	5.67	20399	56691	63058	-2073	905	315	-.774	.528	59874	.306
37147.3	944.18	2.85	5.67	20379	56690	63037	-2071	905	312	-.775	.523	59863	.306
37107.3	944.20	2.85	5.68	20359	56688	63016	-2070	904	310	-.777	.518	59852	.306
37067.3	944.22	2.84	5.68	20339	56686	62995	-2069	903	308	-.779	.513	59840	.306
37027.3	944.24	2.83	5.68	20318	56684	62974	-2068	903	306	-.781	.508	59829	.306
36987.3	944.26	2.82	5.69	20298	56682	62953	-2067	902	303	-.783	.504	59817	.306
36947.3	944.28	2.81	5.69	20278	56680	62931	-2065	901	301	-.785	.499	59806	.306
36907.3	944.30	2.80	5.70	20258	56678	62910	-2064	901	299	-.786	.494	59794	.306
36867.3	944.31	2.79	5.70	20238	56676	62889	-2063	900	296	-.788	.489	59782	.305
36827.3	944.34	2.78	5.71	20218	56674	62867	-2062	899	294	-.790	.484	59770	.305
36787.3	944.36	2.77	5.71	20197	56671	62846	-2060	899	292	-.792	.479	59759	.305
36747.3	944.38	2.76	5.72	20177	56669	62824	-2059	898	289	-.794	.474	59747	.305
36707.3	944.40	2.75	5.72	20157	56666	62803	-2058	897	287	-.795	.469	59735	.305
36667.3	944.42	2.75	5.73	20137	56664	62781	-2056	897	285	-.797	.464	59723	.305
36627.3	944.44	2.74	5.73	20117	56661	62759	-2055	896	283	-.799	.459	59710	.305
36587.3	944.46	2.73	5.73	20096	56659	62738	-2053	895	280	-.801	.454	59698	.305
36547.3	944.48	2.72	5.74	20076	56656	62716	-2052	894	278	-.802	.449	59686	.305
36507.3	944.51	2.71	5.74	20056	56653	62694	-2051	894	276	-.804	.444	59673	.304
36467.3	944.53	2.70	5.75	20036	56650	62672	-2049	893	273	-.806	.439	59661	.304
36427.3	944.55	2.69	5.75	20016	56647	62649	-2048	892	271	-.808	.434	59648	.304
36387.3	944.58	2.68	5.76	19995	56644	62627	-2046	891	269	-.810	.429	59636	.304
36347.3	944.60	2.67	5.76	19975	56641	62605	-2045	891	266	-.811	.424	59623	.304
36307.3	944.62	2.66	5.77	19955	56638	62582	-2043	890	264	-.813	.419	59610	.304
36267.3	944.65	2.65	5.77	19935	56635	62560	-2042	889	262	-.815	.414	59597	.304
36227.3	944.67	2.64	5.78	19915	56631	62537	-2040	888	260	-.817	.408	59584	.304
36187.3	944.70	2.63	5.78	19894	56628	62515	-2038	887	257	-.818	.403	59571	.303
36147.3	944.72	2.62	5.79	19874	56624	62492	-2037	886	255	-.820	.398	59558	.303

Amendment 79
3/30/70

X(A) COORDINATES

TABLE 3.3-24 (CONTINUED)

CSM-109 PLANE CHANGE 1

WEIGHT LBS.	X-BAF	Y-BAF INCHES	Z-BAR	IXX	IYY	IZZ SLUG-FT. SQ	PXY	PXZ	PYZ	PITCH DEGREES	YAW	AVERAGE MOMENT	INERTIA/THRUST RATIO
36107.3	944.75	2.62	5.79	19854	56620	62469	-2035	886	253	-.822	.393	59545	.303
36067.3	944.77	2.61	5.80	19834	56617	62446	-2033	885	250	-.824	.398	59532	.303
36027.3	944.80	2.60	5.80	19814	56613	62423	-2032	884	249	-.825	.383	59518	.303
35987.3	944.83	2.59	5.81	19793	56609	62400	-2030	883	246	-.827	.377	59505	.303
35947.3	944.85	2.58	5.81	19773	56605	62377	-2028	882	244	-.829	.372	59491	.303
35907.3	944.88	2.57	5.81	19753	56601	62354	-2027	881	241	-.830	.367	59477	.302
35867.3	944.91	2.56	5.82	19733	56597	62330	-2025	880	239	-.832	.362	59463	.302

SNA-8-D-027(III)REV 2

X(1) COORDINATES

TABLE 3.3-25

CSM-109 PLANE CHANGE 2

WFLIGHT LBS.	Y-924	Y-PAI INCHES	Z-HCP	IXX	IYY	IZZ SLUG-FT SQ	PXY	PXZ	PLY	PITCH DEGREES	YAW	AVERAGE MOMENT	INERTIA/THRUST RATIO
37221.4	944.89	3.00	5.45	20195	56470	62802	-1965	804	345	-.643	.588	59636	.303
37181.4	944.91	2.99	5.45	20176	56468	62781	-1964	803	343	-.645	.583	59624	.303
37141.4	944.93	2.98	5.45	20156	56466	62759	-1963	803	340	-.647	.579	59613	.303
37101.4	944.95	2.97	5.46	20136	56464	62738	-1961	802	338	-.648	.574	59601	.303
37051.4	944.97	2.96	5.47	20116	56462	62717	-1960	801	336	-.650	.569	59589	.303
37021.4	944.99	2.96	5.47	20096	56459	62695	-1959	801	334	-.652	.564	59577	.303
36981.4	945.01	2.95	5.48	20075	56457	62674	-1958	800	331	-.653	.559	59565	.302
36941.4	945.04	2.94	5.48	20055	56454	62652	-1956	799	329	-.655	.555	59553	.302
36901.4	945.06	2.93	5.48	20035	56452	62630	-1955	799	327	-.657	.550	59541	.302
36861.4	945.08	2.92	5.49	20015	56449	62608	-1954	798	324	-.658	.545	59529	.302
36821.4	945.10	2.91	5.49	19995	56447	62587	-1952	797	322	-.660	.540	59517	.302
36781.4	945.12	2.90	5.50	19975	56444	62565	-1951	797	320	-.662	.535	59504	.302
36741.4	945.14	2.89	5.50	19955	56441	62543	-1949	796	317	-.663	.530	59492	.302
36701.4	945.17	2.88	5.51	19934	56438	62521	-1948	795	315	-.665	.525	59479	.302
36661.4	945.19	2.87	5.51	19914	56435	62498	-1947	795	313	-.666	.521	59467	.302
36621.4	945.21	2.87	5.51	19894	56432	62476	-1945	794	310	-.668	.516	59454	.301
36581.4	945.24	2.86	5.52	19874	56429	62454	-1944	793	308	-.670	.511	59441	.301
36541.4	945.26	2.85	5.52	19854	56426	62431	-1942	792	306	-.671	.506	59428	.301
36501.4	945.29	2.84	5.53	19834	56422	62409	-1941	791	303	-.673	.501	59416	.301
36461.4	945.31	2.83	5.53	19814	56419	62386	-1939	791	301	-.675	.496	59403	.301
36421.4	945.33	2.82	5.54	19793	56415	62364	-1937	790	299	-.676	.491	59389	.301
36381.4	945.36	2.81	5.54	19773	56412	62341	-1936	789	296	-.678	.486	59376	.301
36341.4	945.38	2.80	5.54	19753	56408	62318	-1934	788	294	-.679	.481	59363	.300
36301.4	945.41	2.79	5.55	19733	56404	62295	-1933	788	292	-.681	.476	59350	.300
36261.4	945.44	2.78	5.55	19713	56400	62272	-1931	787	289	-.683	.471	59336	.300
36221.4	945.46	2.77	5.56	19693	56396	62249	-1929	786	287	-.684	.466	59323	.300
36181.4	945.49	2.77	5.56	19672	56392	62226	-1928	785	285	-.686	.461	59309	.300
36141.4	945.52	2.76	5.57	19652	56388	62202	-1926	784	282	-.688	.456	59295	.300
36101.4	945.54	2.75	5.57	19632	56384	62179	-1924	783	280	-.689	.450	59281	.300
36061.4	945.57	2.74	5.58	19612	56380	62155	-1922	782	278	-.691	.445	59267	.299
36021.4	945.60	2.73	5.58	19592	56375	62132	-1921	782	276	-.692	.440	59253	.299
35981.4	945.63	2.72	5.58	19571	56370	62108	-1919	781	273	-.694	.435	59239	.299
35941.4	945.66	2.71	5.59	19551	56366	62084	-1917	780	271	-.695	.430	59225	.299
35901.4	945.68	2.70	5.59	19531	56361	62060	-1915	779	269	-.697	.425	59211	.299
35861.4	945.71	2.69	5.60	19511	56356	62036	-1913	778	266	-.699	.420	59196	.299
35821.4	945.74	2.68	5.60	19491	56351	62012	-1912	777	264	-.700	.415	59181	.299
35781.4	945.77	2.67	5.61	19471	56346	61987	-1910	776	262	-.702	.409	59167	.298

X-Y-Z COORDINATES

TABLE 3.3-25 (CONTINUED)

CSM-109 PLANE CHANGE 2

WEIGHT LBS.	X-BAR	Y-BAR INCHES	Z-BAR	IXX	IYY	IZZ SLUG-FT SQ	PXY	PXZ	PYZ	PITCH DEGREES	YAW DEGREES	AVERAGE MOMENT	INERTIA/THRUST RATIO
35741.4	945.80	2.66	5.61	19450	56341	61963	-1908	775	259	-.703	.404	59152	.298
35701.4	945.83	2.65	5.62	19430	56336	61939	-1906	774	257	-.705	.399	59137	.298
35661.4	945.86	2.64	5.62	19410	56330	61914	-1904	773	255	-.706	.394	59122	.298
35621.4	945.87	2.63	5.63	19390	56325	61899	-1902	772	252	-.708	.389	59107	.298
35581.4	945.93	2.62	5.63	19370	56319	61864	-1900	771	250	-.709	.383	59092	.298
35541.4	945.96	2.61	5.64	19349	56313	61839	-1898	770	248	-.711	.378	59076	.297
35501.4	945.99	2.60	5.64	19329	56307	61814	-1896	769	246	-.713	.373	59061	.297
35461.4	946.02	2.59	5.64	19309	56301	61789	-1894	768	243	-.714	.368	59045	.297
35421.4	946.05	2.59	5.65	19299	56295	61764	-1892	767	241	-.716	.362	59029	.297
35381.4	946.09	2.58	5.65	19279	56289	61738	-1890	766	239	-.717	.357	59013	.297
35341.4	946.12	2.57	5.66	19249	56282	61712	-1888	765	236	-.719	.352	58997	.297
35301.4	946.15	2.56	5.66	19228	56276	61687	-1885	764	234	-.720	.346	58981	.296
35261.4	946.19	2.55	5.67	19208	56269	61661	-1883	763	232	-.722	.341	58965	.296
35221.4	946.22	2.54	5.67	19188	56262	61635	-1881	762	229	-.723	.336	58948	.296
35181.4	946.26	2.53	5.68	19168	56255	61609	-1879	761	227	-.725	.330	58932	.296
35141.4	946.29	2.52	5.68	19147	56248	61582	-1877	760	225	-.726	.325	58915	.296
35101.4	946.33	2.51	5.69	19127	56241	61556	-1874	758	223	-.728	.320	58899	.296
35061.4	946.36	2.50	5.69	19107	56234	61529	-1872	757	220	-.729	.314	58881	.295
35021.4	946.40	2.49	5.70	19097	56226	61503	-1870	756	218	-.731	.309	58864	.295
34981.4	946.43	2.48	5.70	19066	56218	61476	-1867	755	216	-.732	.303	58847	.295
34941.4	946.47	2.47	5.71	19046	56211	61449	-1865	754	213	-.734	.298	58830	.295
34901.4	946.51	2.46	5.71	19026	56203	61422	-1863	753	211	-.735	.293	58812	.295
34861.4	946.54	2.45	5.72	19006	56195	61394	-1860	751	209	-.737	.287	58795	.295
34821.4	946.58	2.44	5.72	18996	56186	61367	-1858	750	207	-.738	.282	58777	.294
34781.4	946.62	2.43	5.72	18965	56178	61339	-1856	749	204	-.740	.276	58759	.294
34741.4	946.66	2.42	5.73	18945	56170	61312	-1853	748	202	-.741	.271	58741	.294
34701.4	946.70	2.41	5.73	18925	56161	61284	-1851	747	200	-.743	.265	58722	.294
34661.4	946.74	2.40	5.74	18905	56152	61256	-1848	745	197	-.744	.260	58704	.294
34621.4	946.78	2.39	5.74	18894	56143	61228	-1846	744	195	-.745	.254	58685	.293
34581.4	946.82	2.38	5.75	18864	56134	61199	-1843	743	193	-.747	.249	58667	.293
34541.4	946.86	2.37	5.75	18844	56125	61171	-1841	742	191	-.748	.243	58648	.293
34501.4	946.90	2.36	5.76	18824	56115	61142	-1838	740	188	-.750	.238	58629	.293
34461.4	946.94	2.35	5.76	18803	56105	61113	-1835	739	186	-.751	.232	58609	.293
34421.4	946.99	2.34	5.77	18773	56096	61084	-1833	738	184	-.753	.226	58590	.292
34381.4	947.02	2.33	5.77	18753	56086	61055	-1830	736	181	-.754	.221	58570	.292
34341.4	947.05	2.32	5.78	18743	56076	61026	-1827	735	179	-.755	.215	58551	.292
34301.4	947.10	2.31	5.78	18722	56065	60996	-1825	734	177	-.757	.210	58531	.292

(IA) COORDINATES

TABLE 3.3-25 (CONTINUED)

CSM-109 PLANE CHANGE 2

WEIGHT LBS.	X-RAF	Y-RAF INCHES	Z-RAF	IXX	IYY	IZZ SLUG-FT SQ	PXY	PXZ	PYZ	PITCH DEGREES	YAW	AVERAGE MOMENT	INERTIA/THRUST RATIO
34251.4	947.15	2.30	5.79	18702	56055	60966	-1822	732	175	-.758	.204	58511	.292
34221.4	947.19	2.29	5.79	18682	56044	60936	-1819	731	172	-.760	.198	58490	.291
34181.4	947.23	2.27	5.80	18662	56033	60906	-1816	730	170	-.761	.193	58470	.291
34141.4	947.28	2.25	5.80	18641	56022	60876	-1813	728	168	-.762	.197	58449	.291
34101.4	947.32	2.25	5.81	18621	56011	60846	-1811	727	165	-.764	.181	58428	.291
34061.4	947.37	2.24	5.81	18601	56000	60815	-1808	725	163	-.765	.176	58407	.290
34021.4	947.41	2.23	5.82	18581	55988	60784	-1805	724	161	-.767	.170	58386	.290
33981.4	947.46	2.22	5.82	18560	55976	60753	-1802	723	159	-.768	.164	58365	.290
33941.4	947.50	2.21	5.83	18540	55965	60722	-1799	721	156	-.769	.159	58343	.290
33901.4	947.55	2.20	5.83	18520	55952	60691	-1796	720	154	-.771	.153	58322	.290
33861.4	947.59	2.19	5.84	18499	55940	60659	-1793	718	152	-.772	.147	58300	.289
33821.4	947.64	2.18	5.84	18479	55928	60627	-1790	717	149	-.773	.141	58277	.289
33781.4	947.69	2.17	5.85	18459	55915	60595	-1787	715	147	-.775	.136	58255	.289
33741.4	947.74	2.16	5.85	18439	55902	60563	-1784	714	145	-.776	.130	58233	.289
33701.4	947.78	2.15	5.86	18418	55889	60531	-1781	712	143	-.777	.124	58210	.288
33661.4	947.83	2.14	5.86	18398	55876	60498	-1778	711	140	-.779	.118	58187	.288
33621.4	947.88	2.13	5.87	18378	55862	60466	-1775	709	138	-.780	.113	58164	.288
33581.4	947.93	2.12	5.88	18357	55848	60433	-1772	707	136	-.781	.107	58141	.288
33541.4	947.98	2.11	5.88	18337	55834	60400	-1768	706	134	-.783	.101	58117	.288
33501.4	948.03	2.09	5.89	18317	55820	60366	-1765	704	131	-.784	.095	58093	.287
33461.4	948.08	2.08	5.89	18297	55806	60333	-1762	703	129	-.785	.089	58069	.287
33421.4	948.13	2.07	5.90	18276	55791	60299	-1759	701	127	-.787	.083	58045	.287
33381.4	948.18	2.06	5.90	18256	55777	60265	-1755	699	125	-.788	.077	58021	.287
33341.4	948.23	2.05	5.91	18236	55762	60230	-1752	698	122	-.789	.072	57996	.286
33301.4	948.29	2.04	5.91	18215	55746	60196	-1749	696	120	-.791	.066	57971	.286
33261.4	948.34	2.03	5.92	18195	55731	60161	-1745	695	118	-.792	.060	57946	.286
33221.4	948.39	2.02	5.92	18175	55715	60126	-1742	693	116	-.793	.054	57921	.286
33181.4	948.45	2.01	5.93	18154	55700	60091	-1738	691	113	-.794	.048	57895	.285
33141.4	948.50	2.00	5.93	18134	55683	60056	-1735	689	111	-.796	.042	57870	.285
33101.4	948.55	1.99	5.94	18114	55667	60020	-1731	688	109	-.797	.036	57844	.285
33061.4	948.61	1.97	5.94	18093	55651	59985	-1728	686	106	-.798	.030	57818	.284
33021.4	948.66	1.96	5.95	18073	55634	59948	-1724	684	104	-.799	.024	57791	.284
32981.4	948.72	1.95	5.95	18053	55617	59912	-1721	683	102	-.801	.018	57764	.284
32941.4	948.77	1.94	5.96	18032	55600	59876	-1717	681	100	-.802	.012	57738	.284
32901.4	948.82	1.93	5.97	18012	55582	59839	-1714	679	97	-.803	.006	57710	.283
32861.4	948.89	1.92	5.97	17992	55564	59802	-1710	677	95	-.804	.000	57683	.283
32821.4	948.94	1.91	5.98	17972	55546	59765	-1706	675	93	-.806	-.006	57655	.283

X(1) COORDINATES

TABLE 3.3-26

CSM-109 T.E.I. BURN

WEIGHT LBS.	X-RAC	Y-RAC INCHES	Z-RAC	IXX	IYY	IZZ SLUG-FT SQ	PXY	PXZ	PYZ	PITCH DEGREES	YAW	AVERAGE MOMENT	INERTIA/THRUST RATIO
35319.9	946.10	2.59	5.65	19212	56226	51697 -1873	780	245	-0.713	.366	58962	.297	
35119.9	946.27	2.54	5.67	19111	56193	61568 -1862	775	234	-0.720	.339	58881	.296	
34919.9	946.45	2.49	5.69	19010	56156	61436 -1851	769	222	-0.728	.312	58796	.295	
34719.9	946.63	2.44	5.72	18909	56116	61303 -1839	763	211	-0.735	.285	58709	.294	
34519.9	946.83	2.39	5.74	18807	56072	61160 -1827	757	199	-0.742	.257	58616	.293	
34319.9	947.03	2.34	5.77	18706	56025	61016 -1814	751	188	-0.750	.229	58520	.292	
34119.9	947.25	2.29	5.79	18605	55973	60867 -1800	744	176	-0.757	.201	58420	.291	
33919.9	947.47	2.24	5.82	18504	55916	60715 -1786	737	165	-0.764	.173	58315	.290	
33719.9	947.70	2.19	5.84	18402	55855	60557 -1771	730	154	-0.770	.144	58206	.289	
33519.9	947.94	2.13	5.87	18301	55799	60395 -1755	722	142	-0.777	.115	58092	.287	
33319.9	948.19	2.08	5.89	18199	55718	60228 -1739	714	131	-0.784	.086	57973	.286	
33119.9	948.46	2.02	5.92	18098	55641	60055 -1722	706	120	-0.790	.056	57848	.285	
32919.9	948.73	1.97	5.95	17995	55559	59876 -1705	697	108	-0.796	.026	57717	.284	
32719.9	949.01	1.91	5.97	17893	55470	59691 -1687	688	97	-0.802	-.004	57581	.282	
32519.9	949.31	1.86	6.00	17793	55376	59500 -1668	679	86	-0.808	-.034	57438	.281	
32319.9	949.61	1.80	6.03	17691	55275	59303 -1648	669	75	-0.814	-.065	57289	.279	
32119.9	949.93	1.74	6.06	17589	55167	59099 -1628	659	63	-0.820	-.096	57133	.278	
31919.9	950.25	1.68	6.08	17487	55053	58898 -1607	649	52	-0.826	-.127	56970	.276	
31719.9	950.59	1.62	6.11	17386	54931	58670 -1585	638	41	-0.831	-.158	56800	.275	
31519.9	950.95	1.56	6.14	17284	54802	58444 -1562	627	30	-0.836	-.190	56623	.273	
31319.9	951.31	1.50	6.17	17182	54664	58210 -1538	616	19	-0.841	-.222	56437	.271	
31119.9	951.69	1.44	6.20	17079	54519	57967 -1514	604	8	-0.846	-.255	56243	.270	
30919.9	952.08	1.38	6.23	16977	54365	57717 -1489	592	-2	-0.851	-.287	56041	.268	
30719.9	952.48	1.31	6.26	16875	54202	57457 -1463	579	-13	-0.856	-.320	55830	.266	
30519.9	952.89	1.25	6.29	16773	54030	57189 -1436	566	-24	-0.860	-.353	55609	.264	
30319.9	953.32	1.19	6.33	16670	53849	56911 -1408	552	-35	-0.864	-.386	55380	.262	
30119.9	953.77	1.12	6.36	16568	53658	56623 -1379	538	-46	-0.868	-.420	55140	.260	
29919.9	954.22	1.05	6.39	16465	53457	56325 -1350	524	-57	-0.872	-.453	54891	.258	
29719.9	954.70	.99	6.42	16363	53245	56016 -1319	509	-68	-0.876	-.487	54631	.255	
29519.9	955.18	.91	6.46	16260	53023	55697 -1287	494	-79	-0.879	-.522	54360	.253	
29319.9	955.69	.84	6.49	16157	52790	55367 -1255	478	-90	-0.883	-.556	54079	.251	
29119.9	956.20	.77	6.52	16055	52546	55025 -1221	462	-101	-0.886	-.591	53786	.248	
28919.9	956.74	.70	6.56	15952	52289	54672 -1186	445	-111	-0.889	-.625	53481	.246	
28719.9	957.29	.63	6.59	15849	52021	54306 -1151	429	-122	-0.891	-.660	53164	.243	
28519.9	957.85	.55	6.63	15746	51740	53928 -1114	410	-133	-0.894	-.696	52834	.241	
28319.9	958.43	.48	6.66	15643	51447	53538 -1076	392	-143	-0.896	-.731	52492	.238	
28119.9	959.03	.40	6.70	15539	51140	53134 -1037	373	-154	-0.898	-.767	52137	.235	

X(14) COORDINATES

TABLE 3.3-26 (CONTINUED)

CSM-109 T.E.I. BURN

WEIGHT LBS.	X-BAR	Y-BAR INCHES	Z-BAR	IXX	IYY	IZZ SLUG-FT SQ	PXY	PIX	PYZ	PITCH DEGREES	YAW DEGREES	AVERAGE MOMENT	INERTIA/THRUST RATIO
27919.9	959.65	.33	6.74	15436	50220	52716	-997	354	-165	-.900	-.802	51768	.232
27719.9	960.29	.25	6.78	15333	50487	52285	-955	334	-175	-.902	-.838	51386	.230
27519.9	960.33	.17	6.91	15229	50139	51940	-913	313	-186	-.904	-.874	50989	.227
27319.9	961.60	.09	6.85	15126	49776	51380	-869	292	-196	-.905	-.911	50578	.224
27119.9	962.29	.01	6.89	15022	49390	50905	-824	270	-207	-.906	-.947	50152	.221
26919.9	962.99	-.03	6.93	14918	49006	50414	-778	248	-217	-.907	-.984	49710	.217
26719.9	963.72	-.16	6.97	14814	48598	49909	-731	225	-228	-.908	-1.020	49253	.214
26519.9	964.46	-.25	7.01	14710	48174	49387	-682	202	-238	-.908	-1.057	48780	.211
26319.9	965.23	-.33	7.06	14606	47734	48849	-632	178	-248	-.909	-1.094	48291	.208
26119.9	966.02	-.42	7.10	14502	47277	48294	-581	153	-259	-.909	-1.131	47786	.204
25919.9	966.82	-.51	7.14	14398	46804	47722	-529	128	-259	-.909	-1.168	47263	.201
25719.9	967.66	-.60	7.19	14293	46292	47113	-479	101	-279	-.908	-1.206	46703	.197
25519.9	968.51	-.69	7.23	14189	45785	46507	-416	75	-289	-.908	-1.243	46146	.194
25319.9	969.37	-.75	7.27	14084	45275	45899	-364	48	-299	-.908	-1.280	45587	.190
25119.9	970.27	-.89	7.32	13979	44708	45234	-306	19	-309	-.907	-1.318	44971	.186
24919.9	971.21	-.98	7.37	13875	44107	44534	-245	-9	-319	-.905	-1.356	44321	.182
24719.9	972.18	-1.03	7.41	13770	43487	43916	-182	-40	-329	-.903	-1.393	43651	.178
24519.9	973.15	-1.17	7.46	13664	42853	43084	-117	-70	-339	-.902	-1.431	42968	.174
24319.9	974.16	-1.28	7.51	13559	42205	42337	-51	-102	-349	-.900	-1.469	42271	.170
24119.9	975.18	-1.38	7.56	13454	41537	41570	15	-134	-359	-.898	-1.506	41554	.166
23919.9	976.23	-1.48	7.61	13349	40842	40776	83	-167	-368	-.896	-1.544	40809	.162
23719.9	977.32	-1.59	7.66	13243	40111	39945	154	-201	-378	-.893	-1.582	40028	.158
23519.9	978.45	-1.70	7.71	13137	39330	39075	227	-237	-398	-.890	-1.620	39207	.153
23319.9	979.63	-1.81	7.77	13031	38527	38164	303	-274	-397	-.886	-1.658	38346	.149
23119.9	980.83	-1.92	7.82	12925	37684	37222	382	-312	-407	-.882	-1.695	37453	.144
22919.9	982.06	-2.03	7.88	12818	36831	36270	462	-350	-416	-.879	-1.733	36550	.139

X(1) COORDINATES

TABLE 3.3-27

LM-7 PRE P.D.I. TO TOUCHDOWN

WEIGHT LBS.	X-RAK INCHES	Y-RAK INCHES	Z-RAK INCHES	IXX	IYY	IZZ SLUG-FT SQ	PXY	PXZ	PYZ	PILOT ROLL DEGREES	PILOT PITCH DEGREES
33881.6	186.05	-0.05	.64	23787	25777	25643	197	727	388	-0.082	-1.148
33631.6	186.03	-0.05	.65	23529	25716	25618	197	727	388	-0.083	-1.157
33391.6	186.02	-0.05	.65	23471	25653	25592	197	727	388	-0.083	-1.166
33131.6	186.01	-0.05	.66	23314	25590	25565	197	727	388	-0.084	-1.175
32891.6	186.01	-0.05	.66	23156	25525	25536	197	727	388	-0.085	-1.184
32631.6	186.02	-0.05	.67	22998	25458	25506	197	727	388	-0.085	-1.193
32381.6	186.04	-0.05	.67	22840	25391	25475	197	727	388	-0.086	-1.202
32131.6	186.06	-0.05	.68	22682	25322	25442	197	727	388	-0.086	-1.210
31881.6	186.09	-0.05	.68	22524	25251	25407	197	727	388	-0.087	-1.218
31631.6	186.13	-0.05	.69	22366	25179	25371	197	727	388	-0.088	-1.227
31381.6	186.17	-0.05	.69	22208	25105	25334	197	726	388	-0.088	-1.235
31131.6	186.23	-0.05	.70	22049	25029	25294	197	726	388	-0.089	-1.243
30881.6	186.29	-0.05	.70	21891	24952	25253	197	726	388	-0.089	-1.250
30631.6	186.35	-0.05	.71	21733	24872	25211	197	725	388	-0.090	-1.258
30381.6	186.43	-0.05	.72	21575	24791	25166	197	725	388	-0.090	-1.265
30131.6	186.51	-0.05	.72	21417	24709	25119	197	725	388	-0.091	-1.272
29881.6	186.61	-0.05	.73	21259	24624	25071	197	724	388	-0.091	-1.279
29631.6	186.71	-0.05	.73	21100	24537	25021	197	724	388	-0.092	-1.286
29381.6	186.81	-0.05	.74	20942	24448	24968	197	723	388	-0.092	-1.293
29131.6	186.93	-0.05	.75	20784	24357	24913	197	723	388	-0.093	-1.299
28881.6	187.06	-0.05	.75	20626	24264	24857	198	722	388	-0.093	-1.306
28631.6	187.19	-0.05	.76	20467	24169	24798	198	722	388	-0.094	-1.312
28381.6	187.33	-0.05	.77	20309	24071	24737	198	721	388	-0.094	-1.318
28131.6	187.48	-0.06	.77	20151	23971	24673	198	720	388	-0.095	-1.323
27881.6	187.64	-0.06	.78	19993	23869	24607	198	719	388	-0.095	-1.329
27631.6	187.81	-0.06	.79	19834	23764	24539	198	719	388	-0.095	-1.334
27381.6	187.99	-0.06	.79	19676	23657	24468	198	718	388	-0.096	-1.339
27131.6	188.18	-0.06	.80	19519	23547	24394	198	717	388	-0.096	-1.344
26881.6	188.38	-0.06	.81	19360	23435	24318	198	716	388	-0.096	-1.349
26631.6	188.60	-0.06	.82	19201	23320	24239	198	715	388	-0.097	-1.353
26381.6	188.82	-0.06	.82	19043	23202	24158	198	714	388	-0.097	-1.357
26131.6	189.05	-0.06	.83	18885	23081	24073	198	713	388	-0.097	-1.361
25881.6	189.29	-0.06	.84	18726	22957	23995	198	712	388	-0.097	-1.365
25631.6	189.55	-0.06	.85	18568	22829	23894	198	710	388	-0.098	-1.368
25381.6	189.92	-0.06	.86	18410	22699	23800	198	709	388	-0.098	-1.371
25131.6	190.10	-0.06	.87	18252	22565	23703	199	708	388	-0.098	-1.374
24881.6	190.39	-0.06	.87	18093	22428	23602	199	707	388	-0.098	-1.377

(X) COORDINATES

TABLE 3.3-27(CONTINUED)

LM-7 PRE P.D.I. TO TOUCHDOWN

WEIGHT LBS.	X-RAE	Y-RAE INCHES	Z-RAE	IXX	IYY	IZZ SLUG-FT SQ	PXY	PXZ	PYZ	PILOT ROLL DEGREES	PILOT PITCH DEGREES
24431.6	150.69	-0.05	.38	17035	22198	23498	199	705	388	-0.099	-1.379
24381.6	151.01	-0.06	.39	17777	22143	23390	199	704	388	-0.099	-1.381
24131.6	151.35	-0.06	.90	17515	21995	23273	199	702	388	-0.099	-1.383
23881.6	151.69	-0.07	.31	17460	21843	23163	199	700	388	-0.099	-1.385
23631.6	152.04	-0.07	.92	17312	21697	23043	199	699	388	-0.099	-1.386
23381.6	152.44	-0.07	.77	17144	21526	22918	199	697	388	-0.099	-1.387
23131.6	152.83	-0.07	.94	16986	21351	22790	199	695	388	-0.099	-1.388
22881.6	153.24	-0.07	.95	16827	21192	22657	200	693	388	-0.099	-1.388
22631.6	153.67	-0.07	.96	16669	21017	22519	200	691	388	-0.099	-1.388
22381.6	154.12	-0.07	.97	16511	20838	22375	200	689	388	-0.099	-1.388
22131.6	154.58	-0.07	.99	16352	20653	22227	200	687	388	-0.099	-1.388
21881.6	155.05	-0.07	.99	16194	20463	22073	200	685	388	-0.099	-1.387
21631.6	155.57	-0.07	1.01	16036	20267	21914	200	682	388	-0.099	-1.386
21381.6	156.09	-0.07	1.02	15878	20065	21749	201	680	388	-0.099	-1.385
21131.6	156.64	-0.07	1.03	15719	19856	21576	201	677	388	-0.099	-1.384
20881.6	157.20	-0.07	1.04	15561	19642	21398	201	675	388	-0.099	-1.382
20631.6	157.78	-0.06	1.05	15403	19420	21213	201	672	388	-0.099	-1.380
20381.6	158.40	-0.06	1.07	15244	19190	21018	201	669	388	-0.098	-1.378
20131.6	159.04	-0.06	1.08	15086	18951	20816	202	666	388	-0.098	-1.375
19881.6	159.70	-0.06	1.09	14928	18704	20606	202	663	388	-0.098	-1.372
19631.6	200.39	-0.05	1.11	14770	18450	20398	202	660	388	-0.098	-1.369
19381.6	201.10	-0.05	1.12	14611	18199	20162	202	656	388	-0.098	-1.365
19131.6	201.84	-0.05	1.14	14453	17917	19927	202	653	388	-0.097	-1.362
18881.6	202.62	-0.05	1.15	14295	17636	19683	203	649	388	-0.097	-1.358
18631.6	203.42	-0.05	1.17	14137	17345	19428	203	645	388	-0.097	-1.354
18381.6	204.26	-0.05	1.18	13979	17043	19162	203	641	388	-0.096	-1.349
18131.6	205.13	-0.05	1.20	13820	16729	18884	204	637	388	-0.096	-1.345
17881.6	206.04	-0.05	1.22	13662	16400	18593	204	633	388	-0.096	-1.340
17631.6	206.99	-0.05	1.23	13504	16059	18288	204	629	388	-0.095	-1.334
17381.6	207.98	-0.05	1.25	13345	15704	17969	205	624	388	-0.095	-1.329
17131.6	209.01	-0.05	1.27	13188	15334	17635	205	619	388	-0.094	-1.323
16881.6	210.09	-0.05	1.29	13030	14948	17286	205	614	388	-0.094	-1.317
16631.6	211.21	-0.05	1.31	12872	14545	16920	206	609	388	-0.094	-1.310
16381.6	212.38	-0.05	1.33	12714	14124	16535	206	603	388	-0.093	-1.303
16131.6	213.62	-0.10	1.35	12555	13691	16128	206	597	388	-0.093	-1.296
15881.6	214.91	-0.10	1.37	12398	13211	15695	207	591	388	-0.092	-1.289
15631.6	216.29	-0.10	1.39	12240	12709	15229	207	585	388	-0.091	-1.280

LM-7 Ascent Stage Lunar Lift-off Contingencies Mass Properties

Table 3.3-30 presents the LM-7 Ascent Stage Mass Properties for the three contingency cases. The detail equipment mass properties for this table are presented in Table 3.3-32.

Table 3.3-31 presents the CM re-entry mass properties associated with each of the LM-7 Ascent Stage contingencies in Table 3.3-30. Table 3.3-33 presents the detail equipment mass properties.

M M M E E E L E E E L M M M E E L E

Amendment 79
3/30/70

WE COORDINATES
L4-7 ASCENT STAGE OFF NOMINAL LUNAR LIFTOFF MASS PROPERTIES

TABLE 3.3-30

DESCRIPTION	S	WEIGHT POUNDS	C. G. INCHES			INERTIAS SLUG-FT ²			PRODUCTS SLUG-FT ²		
			X	Y	Z	IXX	IYY	IZZ	PXY	PXZ	PYZ
ASCENT STAGE AT TD	+	10026.0	243.2	.2	3.2	6005	3405	5936	66	177	-13
EQUIP. RELOC.	-	74.4	249.7	-.7	19.1	12	16	9	0	0	0
EQUIP. RELOC.	+	74.4	267.7	-.8	2.2	15	23	10	0	0	0
A/S AT LIFTOFF PRE EVA 1		10026.0	243.3	.2	3.1	6003	3496	5945	65	174	-13
ASCENT STAGE AT TD	+	10026.0	243.2	.2	3.2	6005	3405	5936	66	177	-13
EQUIP. RELOC.	-	261.7	245.0	-7.0	26.4	32	45	40	0	0	0
EQUIP. RELOC.	+	261.7	241.3	-5.6	30.1	30	44	37	0	0	0
OFF LOAD	-	10.7	250.3	-15.6	20.6	1	1	0	0	0	0
ON LOAD	+	126.9	257.6	-11.0	-11.8	4	13	15	0	0	0
A/S AT LIFTOFF PRE EVA 2		10943.0	243.2	.1	3.1	6024	3516	5954	63	164	-7
ASCENT STAGE AT TD	+	10026.0	243.2	.2	3.2	6005	3405	5936	66	177	-13
EQUIP. RELOC.	-	243.7	246.7	-6.9	26.9	28	43	40	0	0	0
EQUIP. RELOC.	+	243.7	239.0	-5.3	32.3	24	35	32	0	0	0
OFF LOAD	-	59.5	236.6	-8.6	4.0	12	14	8	0	0	0
ON LOAD	+	227.4	263.8	-12.1	-11.2	7	18	21	0	0	0
A/S AT LIFTOFF PRE DEPRES		10994.7	243.5	.0	3.0	6026	3526	5966	55	153	-3

SMA-8-D-027(III)REV 2

Amendment 79
3/30/70

YZ COORDINATES TABLE 3.3-31
CM AT ENTRY MASS PROPERTIES DEPENDING ON A/S ABORT

DESCRIPTION	S	WEIGHT POUNDS	C. G. INCHES			INERTIAS SLUG-FT ²			PRODUCTS SLUG-FT ²		
			X	Y	Z	I _{XX}	I _{YY}	I _{ZZ}	P _{XY}	P _{XZ}	P _{YZ}
CM AT ENTRY (NOM)	+	12565.3	1039.5	.1	6.3	5948	5269	4683	55	-422	-36
LM TO CM NOM. TP.	-	203.0	1024.2	2.3	22.0	39	31	15	0	0	0
CM AT ENTRY PRE EVA 1		12362.3	1039.8	.1	6.0	5897	5216	4657	56	-411	-37
CM AT ENTRY (NOM)	+	12565.3	1039.5	.1	6.3	5948	5269	4683	55	-422	-36
LM TO CM NOM. TP.	-	203.0	1024.2	2.3	22.0	39	31	15	0	0	0
LM TO CM EVA1 TP	+	102.6	1024.1	-12.4	16.6	22	22	3	0	0	0
CM AT ENTRY PRE EVA 2		12464.9	1039.6	-0	6.1	5925	5246	4669	60	-414	-40
CM AT ENTRY DE- DEFERS.		12565.3	1039.5	.1	6.3	5948	5269	4683	55	-421	-36

SMA-B-D-027(III)REV 2

U
S
S
R
S
P
A
C
E
S
H
I
P
S
S
E
C
I
A
L
I
S
S
U
E

Table 3.3-32

American 79
3/30/70

EMERGENCY LAUNCH STOWAGE LM 7								
BEFORE EVA 1								
ITEMS REARRANGED								
LM COORDINATES								
DESCRIPTION	STOW. ITEM	REF	NO.	STOWAGE LOCATION	WEIGHT	X-C.G.	Y-C.G.	Z-C.G.
JETTISON BAG NO.1	B1027.	20	1	LH SIDE STOW.COMB	.9	235.0	-34.0	45.0
ADAPTER, SFC/OPS	B3004.	20	1	SFC RACK NO.1-LH	2.2	257.4	-20.7	-6.0
ADAPTER, SFC/OPS	B3004.	20	1	SFC RACK NO.2-DR	2.2	265.0	-20.7	-6.0
ARM REST, LH-CDR.	T30	20	1	CREW STATION-CDR	1.1	260.0	.0	45.0
ARM RESTS, RH + LH-LMP.	T30	20	2	CREW STATION-CDR	2.2	260.0	.0	45.0
CAMERAS, 70MM	A1015.	20	2	RH SIDE STOW.COMB	5.4	238.4	38.6	46.0
RCU-PLSS	B1001.	20	2	ON FLOOR (HATCHWAY)	9.0	219.7	.0	44.7
CHECKLIST, EVA CUFF-CDR.	A1040.	20	1	ON EV GLOVE(CDR.HSB)	.3	260.0	-5.5	-1.5
CHECKLIST, EVA CUFF-CDR.	A1040.	20	1	ON EV GLOVE(LMP.HSB)	.3	260.0	5.5	6.0
ISA (MODIFIED)	T9D	20	1	TBD (ISA MOD.)	6.8	280.0	.0	-10.0
PLSS/EVC-LMP.	B1025.	20	1	ON FLOOR (HATCHWAY)	9.4	219.7	.0	44.7
STRAPS, ATTACH, OPS/PGA-LMP	B1022.	20	2	ATTACH PLSS(CABN.FLR	.6	219.7	.0	44.7
CONVEYR ASSY, LUNAR EQUIP(LEC)	B1020.2	20	1	BAG ASSY, LEC+WT(LHMS	1.4	236.0	-16.5	16.2
SUP.SFO.CAMERA ASSY + BAG	A0155.	20	1	TBD(EST.GR./BAT.CAM)	8.4	256.0	1.2	34.3
BAG, HELMET STOWAGE-CDR.	B1013.	20	1	ON ASC.ENGINE COVER	1.4	260.0	5.5	6.0
BAG, HELMET STOWAGE-LMP.	B1013.	20	1	ON ASC.ENGINE COVER	1.4	260.0	-5.5	-1.5
TETHER, EVA WAIST	B1020.6	20	1	BAG ASSY, LEC+WT(LHMS	.6	236.0	-16.5	16.2
TETHER, EVA WAIST	B1020.7	20	1	BAG ASSY, LEC+WT(LHMS	.6	236.0	-16.5	16.2
TV CAMERA ASSY.	B1000.	20	1	ON MINUS 227 BRD	7.6	272.0	.0	-18.0
GLOVES, EV-PAIR	B1015.	20	1	IN HSB (ASC ENG.CDR)	2.2	260.0	5.5	6.0
GLOVES, EV-PAIR	B1015.	20	1	IN HSB (ASC ENG.CDR)	2.2	260.0	-5.5	-1.5
VISOR, EV	B1014.	20	1	IN HSB (ASC ENG.CDR)	4.1	260.0	5.5	6.0
VISOR, EV	B1014.	20	1	IN HSB (ASC ENG.CDR)	4.1	260.0	-5.5	-1.5
TOTAL INITIAL LOCATION A/S					74.40	249.70	.72	19.11

NOTE: Further information relating to this table is given on pages 3.3-18, 3.3-19 and 3.3-20

SNA-8-D-0. III)REV 2

U
S
N
A
S
P
A
C
E
S
H
I
P
C
O
R
P
O
R
A
T
I
O
N

Amendment 79
3/30/70

Table 3.3-32 (Continued)

EMERGENCY LAUNCH STOWAGE LM 7								
BEFORE EVA 1 ITEMS REARRANGED					LM COORDINATES			
DESCRIPTION	STOW. ITEM	REF	NO.	STOWAGE LOCATION	WEIGHT	X-C.G.	Y-C.G.	Z-C.G.
JETTISON BAG NO. 1	81027.	20	1	IN ISA (HUNG AFT)	.9	281.8	.0	-19.0
ADAPTER, SRC/OPS	03004.	20	1	ISA (JETT.BAG)	2.2	281.8	.0	-19.0
ADAPTER, SRC/OPS	03004.	20	1	ISA (JETT.BAG)	2.2	281.8	.0	-19.0
ARM REST, LH-CDR.	T80	20	1	ISA (JETT.BAG)	1.1	281.8	.0	-19.0
ARM RESTS, RH + LH-LMP.	T80	20	2	ISA (JETT.BAG)	2.2	281.8	.0	-19.0
CAMERAS, 70MM	A1015.	20	2	ISA (JETT.BAG)	5.4	281.8	.0	-19.0
RCU-PLSS	81001.	20	2	ISA (JETT.BAG)	9.0	281.8	.0	-19.0
CHECKLIST, EVA CUFF-CDR.	A1040.	20	1	IN HSB (ON FLOOR)	.3	221.0	-18.3	53.0
CHECKLIST, EVA CUFF-CDR.	A1040.	20	1	IN HSB (ON FLOOR)	.3	221.0	18.3	53.0
ISA (MODIFIED)	T80	20	1	ATTACHED AFT	6.8	281.8	.0	-19.0
PLSS/EVC-LMP.	81025.	20	1	DONNING STATION	9.4	275.0	-5.0	19.2
STRAPS, ATTACH, OPS/PGA-LMP	81022.	20	2	ATTACH PLSS (DON.STA)	.6	275.0	-5.0	19.2
CONVEYOR ASSY, LUNAR EQUIP (LFC)	81020.2	20	1	ISA (JETT.BAG)	1.4	281.8	.0	-19.0
SUR. SEQ. CAMERA ASSY + BAG	A0155.	20	1	ISA (JETT.BAG)	8.4	281.8	.0	-19.0
BAG, HELMET STOWAGE-CDR.	81013.	20	1	ON CABIN FLOOR/HSB	1.4	221.0	-18.3	53.0
BAG, HELMET STOWAGE-LMP.	81013.	20	1	ON CABIN FLOOR/HSB	1.4	221.0	18.3	53.0
TETHER, EVA WAIST	81020.6	20	1	ATTACH PLSS (DON.STA)	.6	275.0	-5.0	19.2
TETHER, EVA WAIST	81020.7	20	1	ATTACH PLSS (DON.STA)	.6	275.0	-5.0	19.2
TV CAMERA ASSY.	E1000.	20	1	ISA (JETT.BAG)	7.6	281.8	.0	-19.0
GLOVES, EV-PAIR	81015.	20	1	IN HSB (ON FLOOR)	2.2	221.0	-18.3	53.0
GLOVES, EV-PAIR	81015.	20	1	IN HSB (ON FLOOR)	2.2	221.0	18.3	53.0
VISOR, EV	81014.	20	1	IN HSB (ON FLOOR)	4.1	221.0	-18.3	53.0
VISOR, EV	81014.	20	1	IN HSB (ON FLOOR)	4.1	221.0	18.3	53.0
TOTAL RELOCATED IN A/S					74.40	267.70	-5.75	2.23

NOTE: Further information relating to this table is given on pages 3.3-18, 3.3-19 and 3.3-20

SNA-8-D-027(III)REV 2

Table 3.3-3: (Continued)

EMERGENCY LAUNCH STOWAGE LM 7								
BEFORE EVA 2 ITEMS REARRANGED					LM COORDINATES			
DESCRIPTION	STOW. ITEM	REF	NO.	STOWAGE LOCATION	WEIGHT	Y-C.G.	Y-C.G.	Z-C.G.
JETTISON BAG NO.2	81027.	20	1	LH SIDE STOW.COMPT.	.7	235.0	-34.0	45.0
HAMMOCK-COR.	03049.	20	1	UNDER LHSSC	4.1	226.1	-34.3	41.9
HAMMOCK-LMP.	03050.	20	1	UNDER LHSSC	4.1	226.1	-34.3	41.9
TOWELS,LM UTILITY (RED)	81043.	20	2	HAMMOCK(UNDER LHSSC)	.2	226.1	-34.3	41.9
TOWELS,LM UTILITY (BLUE)	81044.	20	2	HAMMOCK(UNDER LHSSC)	.2	226.1	-34.3	41.9
CANNISTER,ECS LIQH	03008.	20	1	AFT OF A/S ENG.CVR.	9.2	250.0	8.8	-11.8
STRAP,ECS LIQH CANNISTER	03024.	20	1	ON CRT(A/S ENG.CVR.	.1	250.0	8.8	-11.8
LUNAR OVERSHOES-PAIR	81018.	20	2	BOOT COMPART.(LHMS)	9.0	279.6	-20.5	8.5
CAMERAS, 70MM	41015.	20	2	RH SIDE STOW.COMPT.	5.4	238.4	38.6	46.0
BAG,PLSS FEEDWTR COLLECTION	81026.	20	1	RH SIDE STOW.COMPT.	.8	238.4	38.6	46.0
BAG,PLSS FEEDWTR.COL.W/O SCALE	81026.1	20	1	RH SIDE STOW.COMPT.	.5	238.4	38.6	46.0
CONTAINER ASSY.DISP.(FWD LHSSC)	03012.	20	1	LH SIDE STOW.COMPT.	2.8	235.0	-34.0	45.0
FOOD WASTE NO.1	C1000.	20	1	LH MID-SECTION SHELF	3.5	279.6	-20.5	8.5
URINE BAGS	03009.	20	3	RH SIDE STOW.COMPT.	1.0	238.4	38.6	46.0
RCU-PLSS	81001.	20	2	ON FLOOR (HATCHWAY)	9.0	219.7	.0	44.7
CHECKLIST,EVA CUFF-COR.	41040.	20	1	IN HSB (ASC ENG.CVR)	.3	260.0	5.5	6.0
CHECKLIST,EVA CUFF-COR.	41040.	20	1	IN HSB (ASC ENG.CVR)	.3	260.0	-5.5	-1.5
ISA (MODIFIED)	TBD	20	1	ISA(MODIFIED)	6.8	280.0	.0	-10.0
BAG, TEMPORARY STOWAGE	03031.	20	1	ISA(LH MID-SEC.SHLF)	.7	270.3	-15.0	19.0
OXYGEN PURGE SYSTEM	81012.	20	1	ON FLOOR (HATCHWAY)	40.4	219.7	.0	44.7
OXYGEN PURGE SYSTEM	81012.	20	1	ON FLOOR (HATCHWAY)	40.4	219.7	.0	44.7
BRKT,RCU,16MM BAT.OPERAT.CAMR.	A0155.5	20	1	TBD(EST.GR./BAT.CAM)	.3	256.0	1.2	34.3
VALVE ASSY, PURGE	81017.	20	1	TEMP.ST.BG(ISA/LHMS)	.5	270.3	-15.0	19.0
VALVE ASSY, PURGE	81017.	20	1	TEMP.ST.BG(ISA/LHMS)	.5	270.3	-15.0	19.0
PLSS/FVC-LMP.	81025.	20	1	CONNING STATION	9.4	275.0	-5.0	19.2
PLSS/FVC-CMP.	81024.	20	1	RECHARGE STATION	7.7	262.8	-20.8	15.4
STRAPS,ATTACH,OPS/PGA-LMP	81022.	20	2	ATCH TO PLSS/HATCHWY	.5	219.7	.0	44.7
STRAPS,ATCH,OPS/PGA(UNATTACHED)	81021.	20	2	RECHARGE STATION	.4	262.8	-20.8	15.4
TRIGGER, CAMERA	41027.	20	2	RH SIDE STOW.COMPT.	.4	238.4	38.6	46.0
HANDLE,CAMERA	41028.	20	2	RH SIDE STOW.COMPT.	1.0	238.4	38.6	46.0
FILTER, POLARIZING	41005.	20	2	ON 60 MM LENS(RHSSC)	.2	238.4	38.6	46.0
LENS, 60 MM	41016.	20	2	ON 70MM CAMERA(RHSSC)	3.6	238.4	38.6	46.0

NOTE: Further information relating to this table is given on pages 3.3-18, 3.3-19 and 3.3-20.

Table 3.3-32 (Continued)

Amendment 79
3/30/70

EMERGENCY LAUNCH STOWAGE LM 7								
BEFORE EVA 2 ITEMS REARRANGED					LM COORDINATES			
DESCRIPTION	STOW. ITEM	REF	NO.	STOWAGE LOCATION	WEIGHT	X-C.G.	Y-C.G.	Z-C.G.
PROTECTIVE COVER, RESEAU	A1023.	20	2	ON 70MM CAMERA (RHSSC	.4	238.4	38.6	46.0
SUR. SEQ. CAMERA ASSY + BAG	40155.	20	1	TBD (EST. GR./BAT. CAM)	8.4	256.0	1.2	34.3
BAG, HELMET STOWAGE-CDR.	R1013.	20	1	ON ASC. ENGINE COVER	1.4	260.0	5.5	6.0
BAG, HELMET STOWAGE-LMP.	B1013.	20	1	ON ASC. ENGINE COVER	1.4	260.0	-5.5	-1.5
TETHER, EVA WAIST	R1020.6	20	1	BAG ASSY, LEC+WT (LHMS	.6	236.0	-16.5	16.2
TETHER, EVA WAIST	B1020.7	20	1	BAG ASSY, LEC+WT (LHMS	.6	236.0	-16.5	16.2
GLOVES, FV-PAIR	B1015.	20	1	IN HSB (ASC ENG. CVR)	2.2	260.0	5.5	6.0
GLOVES, EV-PAIR	B1015.	20	1	IN HSB (ASC ENG. CVR)	2.2	260.0	-5.5	-1.5
VISOR, EV	B1014.	20	1	IN HSB (ASC ENG. CVR)	4.1	260.0	5.5	6.0
VISOR, EV	B1014.	20	1	IN HSB (ASC ENG. CVR)	4.1	260.0	-5.5	-1.5
GAS CONNECTOR PLUGS	TBD	20	2	TBD (GAS PLUGS)	TBD	.0	.0	.0
TOTAL INITIAL LOCATION A/S					261.71	245.82	-6.99	26.40

NOTE: Further information relating to this table is given on pages 3.3-18, 3.3-19 and 3.3-20

SNA-8-D-027(III)REV 2

Table 3.3-32 (Continued)

EMERGENCY LAUNCH STOWAGE LM 7								
BEFORE EVA 2								
ITEMS REARRANGED								
LM COORDINATES								
DESCRIPTION	STOW. ITEM	REF	NO.	STOWAGE LOCATION	WEIGHT	X-C.G.	Y-C.G.	Z-C.G.
JETTISON BAG NO.2	81027.	20	1	TIED TO CABIN FLOOR	.9	238.0	.0	35.0
HAMMOCK-CDR.	03049.	20	1	IN JETT.BAG/ON FLOOR	4.1	238.0	.0	35.0
HAMMOCK-LMP.	03050.	20	1	IN JETT.BAG/ON FLOOR	4.1	238.0	.0	35.0
TOWELS,LM UTILITY (RED)	81043.	20	2	IN JETT.BAG/ON FLOOR	.2	238.0	.0	35.0
TOWELS,LM UTILITY (BLUE)	81044.	20	2	IN JETT.BAG/ON FLOOR	.2	238.0	.0	35.0
CANNISTER,FCS LIOM	03008.	20	1	IN JETT.BAG/ON FLOOR	9.2	238.0	.0	35.0
STRAP,ECS LIOM CANNISTER	03024.	20	1	IN JETT.BAG/ON FLOOR	.1	238.0	.0	35.0
LUNAR OVERSHOES-PAIR	81018.	20	2	IN JETT.BAG/ON FLOOR	9.0	238.0	.0	35.0
CAMFRAS, 70MM	41015.	20	2	RH SIDE STOW.COMPT.	5.4	238.4	38.6	46.0
BAG,PLSS FEEDWATER COLLECTION	81026.	20	1	IN JETT.BAG/ON FLOOR	.8	238.0	.0	35.0
BAG,PLSS FEEDWTR.COL.W/O SCALE	81026.1	20	1	IN JETT.BAG/ON FLOOR	.5	238.0	.0	35.0
CONTAINER ASY.DISP.(FWD LHSSC)	03012.	20	1	ATTACHED AFT	2.8	281.8	.0	-19.0
FOOD WASTE NO.1	C1000.	20	1	LHSSC-FWD(HUNG AFT)	3.5	218.8	.0	-19.0
URINE BAGS	03009.	20	3	LHSSC-FWD(HUNG AFT)	1.0	218.8	.0	-19.0
RCU-PLSS	81001.	20	2	BOOT COMPART.(LHMS)	9.0	279.6	-20.5	8.5
CHECKLIST,EVA CUFF-CDR.	A1040.	20	1	IN HSB (ON FLOOR)	.3	221.0	-18.3	53.0
CHECKLIST,EVA CUFF-CDR.	A1040.	20	1	IN HSB (ON FLOOR)	.3	221.0	18.3	53.0
ISA (MODIFIED)	T80	20	1	ATTACHED AFT	6.8	281.8	.0	-19.0
BAG, TEMPORARY STOWAGE	03031.	20	1	PANEL 5	.7	245.0	-22.0	53.0
OXYGEN PURGE SYSTEM	81012.	20	1	ON FLOOR (HATCHWAY)	40.4	219.7	.0	44.7
OXYGEN PURGE SYSTEM	81012.	20	1	ON FLOOR (HATCHWAY)	40.4	219.7	.0	44.7
BRKT,PCU,16MM BAT.OPERAT.CAMR.	A0155.5	20	1	IN JETT.BAG/ON FLOOR	.3	238.0	.0	35.0
VALVE ASSY, PURGE	81017.	20	1	TEMP.STOW.BAG(PNL.5)	.5	245.0	-22.0	53.0
VALVE ASSY, PURGE	81017.	20	1	TEMP.STOW.BAG(PNL.5)	.5	245.0	-22.0	53.0
PLSS/EVC-LMP.	81025.	20	1	ON FLOOR (HATCHWAY)	9.4	219.7	.0	44.7
PLSS/EVC-CMP.	81024.	20	1	RECHARGE STATION	79.7	262.8	-20.8	15.4
STRAPS,ATTACH,OPS/PGA-LMP	81022.	20	2	ATCH PLSS/DONN.STA.	.6	275.0	-5.0	19.2
STRAPS,ATCH,OPS/PGA(UNATTACHED)	81021.	20	2	RECHARGE STATION	.4	262.8	-20.8	15.4
TRIGGER, CAMERA	A1027.	20	2	RH SIDE STOW.COMPT.	.4	238.4	38.6	46.0
HANDLE,CAMERA	A1028.	20	2	RH SIDE STOW.COMPT.	1.0	238.4	38.6	46.0
FILTER, POLARIZING	A1005.	20	2	ON 60 MM LENS(RHSSC)	.2	238.4	38.6	46.0
LENS, 60 MM	A1016.	20	2	ON 70MM CAMERA(RHSSC)	3.6	238.4	38.6	46.0

NOTE: Further information relating to this table is given on pages 3.3-18, 3.3-19 and 3.3-20.

SNA-8-D-027(III)REV 2

Table 3.3-32 (Continued)

Amendment 79
3/30/70

EMERGENCY LAUNCH STOWAGE LM 7								
BEFORE EVA 2								
ITEMS REARRANGED								
LM COORDINATES								
DESCRIPTION	STOW. ITEM	REF	NO.	STOWAGE LOCATION	WEIGHT	X-C.G.	Y-C.G.	Z-C.G.
PROTECTIVE COVER, FESEAU	A1023.	20	2	ON 70MM CAMERA (RHSSC	.4	238.4	38.6	46.0
SUP. SEQ. CAMERA ASSY + BAG	A0155.	20	1	IN JETT. BAG/ON FLOOR	8.4	238.0	.0	35.0
BAG, HELMET STOWAGE-COR.	B1013.	20	1	ON CABIN FLOOR/HSB	1.4	221.0	-18.3	53.0
BAG, HELMET STOWAGE-LMP.	B1013.	20	1	ON CABIN FLOOR/HSB	1.4	221.0	18.3	53.0
TETHER, EVA WAIST	B1020.6	20	1	ATCH PLSS/DONN. STA.	.6	275.0	-5.0	19.2
TETHER, EVA WAIST	B1020.7	20	1	ATCH PLSS/DONN. STA.	.6	275.0	-5.0	19.2
GLOVES, EV-PAIR	B1015.	20	1	IN HSB (ON FLOOR)	2.2	221.0	-18.3	53.0
GLOVES, EV-PAIR	B1015.	20	1	IN HSB (ON FLOOR)	2.2	221.0	18.3	53.0
VISOR, EV	B1014.	20	1	IN HSB (ON FLOOR)	4.1	221.0	-18.3	53.0
VISOR, EV	B1014.	20	1	IN HSB (ON FLOOR)	4.1	221.0	18.3	53.0
GAS CONNECTOR PLUGS	TBD	20	2	TEMP. STOW. BAG (PNL. 5)	TBD	245.0	-22.0	53.0
TOTAL RELOCATED IN A/S					261.71	241.27	-5.63	30.10

NOTE: Further information relating to this table is given on pages 3.3-18, 3.3-19 and 3.3-20

Table 3.3-32 (Continued)

EMERGENCY LAUNCH STOWAGE LM 7								
BEFORE EVA 2								
ITEMS OFF-LOADED								
LM COORDINATES								
DESCRIPTION	STOW. ITEM	REF	NO.	STOWAGE LOCATION	WEIGHT	X-C.G.	Y-C.G.	Z-C.G.
JETTISON BAG NO.1	B1027.	20	1	LH SIDE STOW.COMPT.	.9	235.0	-34.0	45.0
ADAPTER,SRC/OPS	03004.	20	1	SPC RACK NO.1-LWR.	2.2	257.4	-20.7	-6.0
ADAPTER,SRC/OPS	03004.	20	1	SRC RACK NO.2-UPR.	2.2	265.9	-20.7	-6.0
ARM REST,LH-CDP.	TBD	20	1	CREW STATION-CDR/LMP	1.1	260.0	.0	45.0
ARM REST,PH + LH-LMP.	TBD	20	2	CREW STATION-CDR/LMP	2.2	260.0	.0	45.0
CLSRC (WITHOUT SAMPLE)	G4016.	20	1	LH SIDE STOW.COMPT.	.7	235.0	-34.0	45.0
CONVEYOR ASSY,LUNAR EQUIP(LFC)	B1020.2	20	1	BAG ASSY,LEC+WT(LHMS)	1.4	270.3	-15.0	19.0
TOTAL OFF-LOADED FROM A/S					10.70	258.29	-15.56	20.63
EMERGENCY LAUNCH STOWAGE LM 7								
BEFORE EVA 2								
ITEMS UNLOADED								
LM COORDINATES								
DESCRIPTION	STOW. ITEM	REF	NO.	STOWAGE LOCATION	WEIGHT	X-C.G.	Y-C.G.	Z-C.G.
BAG,LUNAR EQUIP.TRANS. (ETB)	03018.	20	1	ISA/HUNG AFT	.9	281.8	.0	-19.0
PLSS BATTERIES (REPLACEMENT)	R1004.	20	2	LHSSC-FWD(HUNG AFT)	11.0	218.8	.0	-19.0
CRT./CAN,PLSS LIOH(REPLACEMENT)	B1003.	20	2	LHSSC-FWD(HUNG AFT)	12.4	218.8	.0	-19.0
CLSRC (WITHOUT SAMPLE)	G4016.	20	1	BOOT COMPART.(LHMS)	.7	279.6	-20.5	8.5
CONTINGENCY SAMPLE	TBD	20	1	CLSRC(BOOT COMP.LHMS)	1.9	279.6	-20.5	8.5
SRC NO.1 (LOADED)	G4003.	20	1	SRC RACK NO.1-LWR.	65.0	257.4	-20.7	-6.0
JETTISON BAG NO.1 (LOADED)	03051	20	1	ISA (JETT.BAG)	35.0	281.8	.0	-19.0
TOTAL ON-LOADED TO A/S					126.90	257.64	-11.02	-11.78

NOTE: Further information relating to this table is given on pages 3.3-18, 3.3-19 and 3.3-20

Table 3.3-32 (Continued)

EMERGENCY LAUNCH STOWAGE LM 7								
POST EVA 2 TO DEPRESS. (BEFORE EQUIPMENT JETTISON)								
ITEMS REARRANGED								
LM COORDINATES								
DESCRIPTION	STOW. ITEM	REF	NO.	STOWAGE LOCATION	WEIGHT	X-C.G.	Y-C.G.	Z-C.G.
PLSS CONDENSATE CONTAINER	03014.	20	1	LH MID-SECTION SHELF	4.8	279.6	-20.5	8.5
JETTISON BAG NO.3	81027.	20	1	LH SIDE STOW.COMPT.	.9	235.0	-34.0	45.0
LUNAR OVERSHOES-PAIR	81018.	20	2	BOOT COMPART.(LHMS)	9.0	279.6	-20.5	8.5
CAMEPAS, 70MM	A1015.	20	2	RH SIDE STOW.COMPT.	5.4	238.4	38.6	46.0
BAG,PLSS FEEDWATER COLLECTION	81026.	20	1	RH SIDE STOW.COMPT.	.8	238.4	38.6	46.0
BAG,PLSS FEEDWTR.COL.W/D SCALE	81026.1	20	1	RH SIDE STOW.COMPT.	.5	238.4	38.6	46.0
ARM REST,FH-CDR.	T8D	20	1	CREW STATION-CDR/LMP	1.1	260.0	.0	45.0
CONTAIN.ASSY,DISPOS(AFT LHSSC)	03012.1	20	1	LH SIDE STOW.COMPT.	2.4	235.0	-34.0	45.0
TETHER,EVA RETRACTABLE(YO-YO)	A1029.	20	2	TEMP-ST.BG(ISA/LHMS)	.4	270.3	-15.0	19.0
RCU-PLSS	81001.	20	2	ON FLOOR (HATCHWAY)	9.0	219.7	.0	44.7
BRACKET, RT. ANGLE	A1021.	20	1	LH SIDE STOW.COMPT.	.2	235.0	-34.0	45.0
CABLE, REMOTE CONTROL	A1022.	20	1	LH SIDE STOW.COMPT.	.7	235.0	-34.0	45.0
BAG, EMESIS-UNUSED	03011.	20	4	RH SIDE STOW.COMPT.	.8	238.4	38.6	46.0
CHECKLIST,EVA CUFF-CDP.	A1040.	20	1	IN HSB (ASC ENG.CVR)	.3	260.0	5.5	6.0
CHECKLIST,EVA CUFF-CDR.	A1040.	20	1	IN HSB (ASC ENG.CVR)	.3	260.0	-5.5	-1.5
FOOD WASTE NO.2	C1000.	20	1	LH MID-SECTION SHELF	3.5	279.6	-20.5	8.5
URINE BAGS	03009.	20	3	RH SIDE STOW.COMPT.	.9	238.4	38.6	46.0
ISA (MODIFIED)	T8D	20	1	ISA (MODIFIED)	6.8	280.0	.0	-10.0
BAG, TEMPORARY STOWAGE	03031.	20	1	ISA(LH MID-SEC.SHLF)	.7	270.3	-15.0	19.0
OXYGEN PURGE SYSTEM	81012.	20	1	ON FLOOR (HATCHWAY)	40.4	219.7	.0	44.7
OXYGEN PURGE SYSTEM	81012.	20	1	ON FLOOR (HATCHWAY)	40.4	219.7	.0	44.7
BRKT,PCU,16MM BAT.OPERAT.CAMR.	A0155.5	20	1	TBD(EST.GR./BAT.CAM)	.3	256.0	1.2	34.3
VALVE ASSY, PURGE	81017.	20	1	TEMP-ST.BG(ISA/LHMS)	.5	270.3	-15.0	19.0
VALVE ASSY, PURGE	81017.	20	1	TEMP-ST.BG(ISA/LHMS)	.5	270.3	-15.0	19.0
PLSS/EVC-LMP.	81025.	20	1	DONNING STATION	9.4	275.0	-5.0	19.2
PLSS/EVC-CMP.	81024.	20	1	RECHARGE STATION	79.7	262.8	-20.8	15.4
STRAPS,ATTACH,OPS/PGA-LMP	81022.	20	2	ATCH TO PLSS/HATCHWY	.6	219.7	.0	44.7
STRAPS,ATCH,OPS/PGA(UNATTACHED)	81021.	20	2	RECHARGE STATION	.4	262.8	-20.8	15.4
TRIGGER, CAMERA	A1027.	20	2	RH SIDE STOW.COMPT.	.4	238.4	38.6	46.0
HANDLE, CAMERA	A1028.	20	2	RH SIDE STOW.COMPT.	1.0	238.4	38.6	46.0
FILTER, POLARIZING	A1005.	20	2	ON 60 MM LENS(RHSSC)	.2	238.4	38.6	46.0
LENS, 60 MM	A1016.	20	2	ON 70MM CAMERA(RHSSC)	3.6	238.4	38.6	46.0

NOTE: Further information relating to this table is given on pages 3.3-18, 3.3-19 and 3.3-20.

Table 3.3-32 (Continued)

Amendment 79
3/30/70

EMERGENCY LAUNCH STOWAGE LM 7								
POST EVA 2 TO DEPRESS. (BEFORE EQUIPMENT JETTISON)								
ITEMS REARRANGED								
LM CORDINI 1655								
DESCRIPTION	STOW. ITEM	REF	NO.	STOWAGE LOCATION	WEIGHT	X-C.G.	Y-C.G.	Z-C.G.
PROTECTIVE COVER, RESFAU	A1023.	20	2	ON 70MM CAMERA (RHSSC	.4	238.4	38.6	46.0
DEFECATION COLLECTION DEVICE	B1009.	20	4	RH SIDE STOW. COMPT.	.8	238.4	38.6	46.0
BAG, HELMET STOWAGE-CDR.	B1013.	20	1	ON ASC. ENGINE COVER	1.4	260.0	5.5	6.0
BAG, HELMET STOWAGE-LMP.	B1013.	20	1	ON ASC. ENGINE COVER	1.4	260.0	-5.5	-1.5
TETHER, EVA WAIST	B1020.6	20	1	BAG ASSY, LEC+WT (LHMS	.6	236.0	-16.5	16.2
TETHER, EVA WAIST	B1020.7	20	1	BAG ASSY, LEC+WT (LHMS	.6	236.0	-16.5	16.2
GLOVES, EV-PAIR	B1015.	20	1	IN HSB (ASC ENG. CVR)	2.2	260.0	5.5	6.0
GLOVES, EV-PAIR	B1015.	20	1	IN HSB (ASC ENG. CVR)	2.2	260.0	-5.5	-1.5
VISOR, EV	B1014.	20	1	IN HSB (ASC ENG. CVR)	4.1	260.0	5.5	6.0
VISOR, EV	B1014.	20	1	IN HSB (ASC ENG. CVR)	4.1	260.0	-5.5	-1.5
GAS CONNECTOR PLUGS	TBD	20	2	TBD (GAS PLUGS)	TBD	.0	.0	.0
TOTAL INITIAL LOCATION A/S					243.71	246.71	-6.94	26.91

NOTE: Further information relating to this table is given on pages 3.3-18, 3.3-19 and 3.3-20

Table 3.3-32 (Continued)

EMERGENCY LAUNCH STOWAGE LM 7								
POST EVA 2 TO DEPRESS. (BEFORE EQUIPMENT JETTISON)								
ITEMS REARRANGED								
LM COORDINATES								
DESCRIPTION	STOW. ITEM	REF	NO.	STOWAGE LOCATION	WEIGHT	X-C.G.	Y-C.G.	Z-C.G.
PLSS CONDENSATE CONTAINER	03014.	20	1	IN JETT.BAG/ON FLOOR	4.8	238.0	.0	35.0
JETTISON BAG NO.3	01027.	20	1	TIED TO CABIN FLOOR	.9	238.0	.0	35.0
LUNAR OVERSHOES-PAIR	01018.	20	2	IN JETT.BAG/ON FLOOR	9.0	238.0	.0	35.0
CAMERAS, 70MM	A1015.	20	2	RH SIDE STOW.COMPT.	5.4	238.4	38.6	46.0
BAG,PLSS FEEDWATER COLLECTION	01026.	20	1	LHSSC(JET.BG/ON FLR)	.8	238.0	.0	35.0
BAG,PLSS FEEDWTR.COL.W/O SCALF	01026.1	20	1	LHSSC(JET.BG/ON FLR)	.5	238.0	.0	35.0
ARM REST,PH-CDR.	T8D	20	1	IN JETT.BAG/ON FLOOR	1.1	238.0	.0	35.0
CONTAIN.ASSY.DISPOS(AFT LHSSC)	03012.1	20	1	IN JETT.BAG/ON FLOOR	2.4	238.0	.0	35.0
TETHER,EVA RETRACTABLE(YO-YO)	A1029.	20	2	LHSSC(JET.BG/ON FLR)	.4	238.0	.0	35.0
RCU-PLSS	01001.	20	2	LHSSC(JET.BG/ON FLR)	9.0	238.0	.0	35.0
BRACKET, RT. ANGLE	A1021.	20	1	LHSSC(JET.BG/ON FLR)	.2	238.0	.0	35.0
CABLE, REMOTE CONTROL	A1022.	20	1	LHSSC(JET.BG/ON FLR)	.7	238.0	.0	35.0
BAG, EMESIS-UNUSED	03011.	20	4	LHSSC(JET.BG/ON FLR)	.8	238.0	.0	35.0
CHECKLIST,EVA CUFF-CDR.	A1040.	20	1	IN HSB (ON FLOOR)	.3	221.0	-18.3	53.0
CHECKLIST,EVA CUFF-CDR.	A1040.	20	1	IN HSB (ON FLOOR)	.3	221.0	18.3	53.0
FOOD WASTE NO.2	C1000.	20	1	LHSSC(JET.BG/ON FLR)	3.5	238.0	.0	35.0
URINE BAGS	03009.	20	3	LHSSC(JET.BG/ON FLR)	.9	238.0	.0	35.0
ISA (MODIFIED)	T8D	20	1	ATTACHED AFT	6.8	281.8	.0	-19.0
BAG, TEMPORARY STOWAGE	03031.	20	1	PANEL 5	.7	245.0	-22.0	53.0
OXYGEN PURGE SYSTEM	01012.	20	1	ON FLOOR (HATCHWAY)	40.4	219.7	.0	44.7
OXYGEN PURGE SYSTEM	01012.	20	1	ON FLOOR (HATCHWAY)	40.4	219.7	.0	44.7
BRKT,RCU,16MM BAT.OPERAT.CAMR.	A0155.5	20	1	IN JETT.BAG/ON FLOOR	.3	238.0	.0	35.0
VALVE ASSY, PURGE	01017.	20	1	TEMP.STOW.BAG(PNL.5)	.5	245.0	-22.0	53.0
VALVE ASSY, PURGE	01017.	20	1	TEMP.STOW.BAG(PNL.5)	.5	245.0	-22.0	53.0
PLSS/EVC-LMP.	01025.	20	1	ON FLOOR (HATCHWAY)	9.4	219.7	.0	44.7
PLSS/EVC-CMP.	01024.	20	1	RECHARGE STATION	79.7	262.8	-20.8	15.4
STRAPS,ATTACH,OPS/PGA-LMP	01022.	20	2	ATCH PLSS/DONN.STA.	.6	275.0	-5.0	19.2
STRAPS,ATCH,OPS/PGA(UNATTACHED)	01021.	20	2	RECHARGE STATION	.4	262.8	-20.8	15.4
TRIGGER, CAMERA	A1027.	20	2	RH SIDE STOW.COMPT.	.4	238.4	38.6	46.0
HANDLE,CAMERA	A1028.	20	2	RH SIDE STOW.COMPT.	1.0	238.4	38.6	46.0
FILTER, POLARIZING	A1005.	20	2	ON 60 MM LENS(RHSSC)	.2	238.4	38.6	46.0
LENS, 60 MM	A1016.	20	2	ON 70MM CAMERA(RHSSC)	3.6	238.4	38.6	46.0

NOTE: Further information relating to this table is given on pages 3.3-18, 3.3-19 and 3.3-20.

Table 3.3-32 (Continued)

Amendment 79
3/30/70

EMERGENCY LAUNCH STOWAGE LM 7								
POST EVA 2 TO DEPRESS. (BEFORE EQUIPMENT JETTISON)								
ITEMS REARRANGED								
DESCRIPTION	STOW. ITEM	REF NO.		STOWAGE LOCATION	WEIGHT	LM COORDINATES		
		REF	NO.			X-C.G.	Y-C.G.	Z-C.G.
PROTECTIVE COVER, RESFAU	A1023.	20	2	ON 70MM CAMERA (RHSSC)	.4	238.4	38.6	46.0
DEFECATION COLLECTION DEVICE	R1009.	20	4	LHSSC (JET. BG/ON FLR)	.9	238.0	.0	35.0
BAG, HELMET STOWAGE-CDR.	01013.	20	1	ON CABIN FLOOR/HSB	1.4	221.0	-18.3	53.0
BAG, HELMET STOWAGE-LMP.	01013.	20	1	ON CABIN FLOOR/HSB	1.4	221.0	18.3	53.0
TETHER, EVA WAIST	01020.6	20	1	ATCH PLSS/DONN. STA.	.6	275.0	-5.0	19.2
TETHER, EVA WAIST	01020.7	20	1	ATCH PLSS/DONN. STA.	.6	275.0	-5.0	19.2
GLOVES, EV-PAIR	01015.	20	1	IN HSB (ON FLOOR)	2.2	221.0	-18.3	53.0
GLOVES, EV-PAIR	01015.	20	1	IN HSB (ON FLOOR)	2.2	221.0	18.3	53.0
VISOR, EV	01014.	20	1	IN HSB (ON FLOOR)	4.1	221.0	-18.3	53.0
VISOR, EV	01014.	20	1	IN HSB (ON FLOOR)	4.1	221.0	18.3	53.0
GAS CONNECTOR PLUGS	T8D	20	2	TEMP. STOW. BAG (PNL. 5)	T8D	245.0	-22.0	53.0
TOTAL RELOCATED IN A/S					243.71	239.82	-5.29	32.33

NOTE: Further information relating to this table is given on pages 3.3-18, 3.3-19 and 3.3-20

Table 3.3-32 (Continued)

EMERGENCY LAUNCH STOWAGE LM 7								
POST EVA 2 TO DEPRESS. (BEFORE EQUIPMENT JETTISON) A-2								
ITEMS OFF-LOADED								
LM COORDINATES								
DESCRIPTION	STOW. ITEM	RFF	NO.	STOWAGE LOCATION	WFIGHT	X-C.G.	Y-C.G.	Z-C.G.
JETTISON BAG NO.1	B1027.	20	1	LH SIDE STOW.COMPT.	.9	235.0	-34.0	45.0
ADAPTER, SRC/OPS	03004.	20	1	SPC RACK NO.1-LWR.	2.2	257.4	-20.7	-6.0
ADAPTER, SPC/OPS	03004.	20	1	SPC RACK NO.2-UPR.	2.2	265.9	-20.7	-6.7
ARM REST, LH-CDP.	TBD	20	1	CREW STATION-CDR/LMP	1.1	260.0	.0	45.0
ARM REST, RH + LH-LMP.	TBD	20	2	CREW STATION-CDR/LMP	2.2	260.0	.0	45.0
JETTISON BAG NO.2	B1027.	20	1	LH SIDE STOW.COMPT.	.9	235.0	-34.0	45.0
HAMMOCK-CDP.	03049.	20	1	UNDER LHSSC	4.1	226.1	-34.3	41.9
HAMMOCK-LMP.	03050.	20	1	UNDER LHSSC	4.1	226.1	-34.3	41.9
TOWELS, LM UTILITY (RED)	B1043.	20	2	HAMMOCK(UNDER LHSSC)	.2	226.1	-34.3	41.9
TOWELS, LM UTILITY (BLUE)	B1044.	20	2	HAMMOCK(UNDER LHSSC)	.2	226.1	-34.3	41.9
CANNISTER, ECS LIQH	03008.	20	1	AFT OF A/S ENG.CVR.	9.2	250.0	8.8	-11.8
STRAP, ECS LIQH CANNISTER	03024.	20	1	ON CRT(A/S ENG.CVR.	.1	250.0	8.8	-11.8
CONTAINER ASY.DISP.(FWD LHSSC)	03012.	20	1	LH SIDE STOW.COMPT.	2.8	235.0	-34.0	45.0
PLSS BATTERIES (REPLACEMENT)	B1004.	20	2	LHSSC-FWD(HUNG AFT)	11.0	218.8	.0	-19.0
CRT./CAN, PLSS LIQH(REPLACEMENT)	91003.	20	2	LHSSC-FWD(HUNG AFT)	12.4	218.8	.0	-19.0
FOOD WASTE NO.1	C1000.	20	1	LH MID-SECTION SHELF	3.5	279.6	-20.5	8.5
URINE BAGS	03009.	20	3	RH SIDE STOW.COMPT.	1.0	238.4	38.6	46.0
CONVEYR ASSY, LUNAR EQUIP(LEC)	B1020.2	20	1	BAG ASSY, LEC+MT(LHMS)	1.4	270.3	-15.0	19.0
TOTAL OFF-LOADED FROM A/S					59.50	236.56	-8.65	3.99

NOTE: Further information relating to this table is given on pages 3.3-18, 3.3-19 and 3.3-20

Amendment 79
3/30/70

Table 3.3-33

EMERGENCY LAUNCH STOWAGE LM 7								
BEFORE EVA 2								
TRANS. TO CM PRIOR TO ASC. JETT.								
APOLLO COORDINATES								
DESCRIPTION	STOW. ITEM	REF	NO.	STOWAGE LOCATION	WEIGHT	X-C.G.	Y-C.G.	Z-C.G.
CLSPC (WITHOUT SAMPLE)	G4016.	20	1	AREA A5	.7	1015.0	9.0	28.0
CONTINGENCY SAMPLE	T8D	20	1	AREA A5	1.9	1015.0	9.0	28.0
S ⁹ C NO.1 (LOADED)	G4003.	20	1	AREA B5	65.0	1031.0	-8.0	39.0
TOTE BAG NO.1 (LOADED)	C3051	20	1	DECONTAM.BAG (ON A1)	35.0	1012.0	-22.0	-26.0
TOTAL TRANS. TO CM					102.60	1024.11	-12.35	16.55

NOTE: Further information relating to this table is given on pages 3.3-18, 3.3-19 and 3.3-20.

Table 3.3-33 (Continued)

EMERGENCY LAUNCH STOWAGE LM 7								
POST EVA 2 TO DEPRESS. (BEFORE EQUIPMENT JETTISON) TRANS. TO CM PRIOR TO ASC. JETT.						APOLLO COORDINATES		
DESCRIPTION	STOW. ITEM	REF	NO.	STOWAGE LOCATION	WEIGHT	X-C.G.	Y-C.G.	Z-C.G.
CLSRC (WITHOUT SAMPLE)	G4016.	20	1	AREA A5	.7	1015.0	9.0	28.0
CONTINGENCY SAMPLE	Y80	20	1	AREA A5	1.9	1015.0	9.0	28.0
SRC NO.1 (LOADED)	G4003.	20	1	AREA B5	65.0	1031.0	-8.0	39.0
SRC NO.2 (LOADED)	G4004.	20	1	AREA B6	65.0	1031.0	13.0	39.0
CASSETTE, CLOSE-UP CAMERA	J4001.	20	1	TEMP.STOW.BAG-LMP.	.5	1036.5	40.0	-25.0
TOTE BAG NO.1 (LOADED)	03051	20	1	DECONTAM.BAG (ON A1)	35.0	1012.0	-22.0	-26.0
TOTE BAG NO.2 (LOADED)	03051.	20	1	ON A7 + A11	35.0	1011.5	25.0	7.0
TOTAL TRANS. TO CM					203.10	1024.17	2.33	21.99

NOTE: Further information relating to this table is given on pages 3.3-18, 3.3-19 and 3.3-20.

Handwritten scribble

3.4 MISSION H3
(CSM 110/LM-8)

U U U U U U U U U U

U U U U U U U U U U

U U U U U U U U U U

U U U U U U U U U U

SUPPLEMENTARY DATA APPLICABLE TO SEQUENTIAL MASS PROPERTIES TABLES

General Comments to be applied to Tables 3.4-1 through 3.4-8:

Inertia data dispersions are +10%.

Dispersions shall be used as 3 σ deviation values.

All initial propellant weights are total tanked.

The (+) or (-) sign following the name of an item indicates that the item is added to or subtracted from the preceding total.

• Table 3.4-1

SM/SPS gimbal angles for SPS abort sequence are: Pitch = -1.417 deg.
Yaw = 1.315 deg.

Tables 3.4-7 and 3.4-8

CSM and LM consumables changes are presented in Tables 3.4-7 and 3.4-8, respectively.

Tables 3.4-4 and 3.4-5

Delta Z	=	0.85 in.
LES motor tilted angles	Delta	= 2.260 deg.
(Delta includes 0.3 deg. for down range dispersions)	Sigma	= 273.810 deg.
LES motor tilted confluence point	X	=1222.300 in.
	Y	= 0.043 in.
	Z	= 0.280 in.
PCM motor tilted angles	Delta	= 89.160 deg.
	Sigma	= 270.000 deg.
PCM motor tilted confluence point	X	=1429.000 in.
	Y	= 0.517 in.
	Z	= 3.320 in.

The docking probe and ring are jettisoned at t=14.0 seconds in Table 3.4-4 and Table 3.4-5.

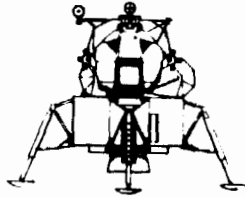

XF COORDINATES
 TABLE 3.4-1
 LM-R EXPECTED SEQUENTIAL MASS PROPERTIES

Amendment 98
 1/22/71

DESCRIPTION	S	WEIGHT POUNDS	C.G. INCHES			INERTIAS SLUG-FT ²			PRODUCTS SLUG-FT ²		
			X	Y	Z	I _{XX}	I _{YY}	I _{ZZ}	P _{XY}	P _{XZ}	P _{YZ}
ASCENT STAGE	+	4732.2	257.7	-4	2.7	2794	2664	1581	66	117	0
LM RCS FUEL	+	102.5	279.1	44.6	14.5	0	0	0	0	0	0
LM RCS FUEL	+	102.4	279.1	-44.6	-14.5	0	0	0	0	0	0
LM RCS OXY	+	200.3	275.4	-44.6	14.5	0	1	1	0	0	0
LM RCS OXY	+	200.4	275.4	44.6	-14.5	0	1	1	0	0	0
LM APS FUEL	+	2001.1	228.0	-71.3	.0	0	0	0	0	0	0
LM APS OXY	+	3209.9	228.0	44.5	.0	0	0	0	0	0	0
ASCENT STAGE		10548.8	244.1	-1	1.2	6653	3323	6032	60	154	-21
DESCENT STAGE	+	4814.5	153.2	-1.8	-2.5	4354	2841	2931	71	30	384
LM DPS FUEL	+	3516.9	159.3	54.0	.0	0	6	6	0	0	0
LM DPS FUEL	+	3516.8	159.3	-54.0	.0	0	6	6	0	0	0
LM DPS OXY	+	5641.9	159.3	.0	54.0	0	9	9	0	0	0
LM DPS OXY	+	5642.0	159.3	.0	-54.0	0	9	9	0	0	0
DESCENT STAGE		23136.5	158.0	-4	-5	15803	10010	7425	74	42	387
LM AT EARTH LAUNCH		33685.3	185.0	-3	.0	22551	24934	25052	169	430	366

DISPERSIONS LB/IN			
DW	DX	DY	DZ
25.0	1.0	.1	.1
1.0	1.0	.1	.1
1.0	1.0	.1	.1
2.0	1.0	.1	.1
2.0	1.0	.1	.1
5.4	1.0	.5	.5
8.7	1.0	.5	.5
27.2	.6	.2	.2
25.0	1.0	.1	.1
7.1	1.0	.5	.5
7.1	1.0	.5	.5
12.7	1.0	.5	.5
12.7	1.0	.5	.5
32.4	.5	.2	.2
42.3	.4	.2	.2

3.4-2

NOTE:

Tanked LM RCS Propellant should be reduced by 0.3 lb fuel and 0.7 lb oxidizer.

SNA-8-D-027(III)REV 2

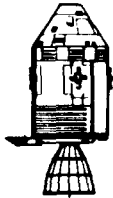

XA COORDINATES TABLE 3.4-2
CSM 110/LMH EXPECTED SEQUENTIAL MASS PROPERTIES

Amendment 98
1/22/71

DESCRIPTION	S	WEIGHT POUNDS	C. G. INCHES			INERTIAS SLUG-FT ²			PRODUCTS SLUG-FT ²		
			X	Y	Z	I _{XX}	I _{YY}	I _{ZZ}	P _{XY}	P _{XZ}	P _{YZ}
SLA PING	+	98.0	835.7	2.0	-6.6	120	65	56	0	0	0
SERVICE MODULE	+	11107.5	918.8	-5.1	10.2	7440	12061	11405	-33	231	-717
COMMAND MODULE	+	12686.7	1040.9	-3.3	5.5	5852	5424	4918	44	-407	-28
COMB LESS SPS PROPELLANT		23894.2	983.3	-2.5	7.7	13494	37057	25524	755	-858	-775
SM SPS F-STOKE	+	6747.9	903.9	-14.8	-47.8	0	1907	1507	0	0	0
SM SPS D-STOKE	+	10737.9	903.7	14.8	47.8	0	3020	3020	0	0	0
SM SPS F-SUMP	+	8868.7	906.8	-48.3	-6.6	0	260P	2608	0	0	0
SM SPS D-SUMP	+	14199.4	907.0	48.3	6.6	0	4210	4210	0	0	0
SM WITH SPS PROPELLANT		51759.4	904.3	5.0	6.5	28415	32946	35891	-270	294	3047
COM AT EARTH LAUNCH		64448.1	934.4	4.0	6.3	34331	77039	79437	-1765	-404	3111

DISPERSIONS LB/IN			
DX	DY	DZ	D ₄
.0	.0	.0	.0
50.0	.4	.1	.1
50.0	.4	.1	.1
70.7	.2	.1	.1
59.0	1.0	.5	.5
121.0	1.0	.5	.5
59.0	1.0	.5	.5
121.0	1.0	.5	.5
196.8	.4	.2	.2
203.1	.4	.2	.2

U
N
I
T
E
D
S
T
A
T
E
S
O
F
A
M
E
R
I
C
A

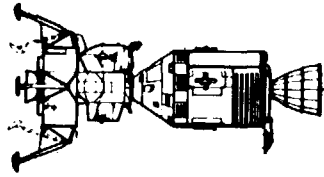

Amendment 98
1/22/71

XA COORDINATES TABLE 3.4-2 (CONTINUED)
CSM 110/LMA EXPECTED SEQUENTIAL MASS PROPERTIES

DESCRIPTION	S	WEIGHT POUNDS	C. G. INCHES			INERTIAS SLUG-FT ²			PRODUCTS SLUG-FT ²		
			X	Y	Z	IXX	IYY	IZZ	PXY	PXZ	PYZ
CSM AT EARTH LAUNCH		64448.1	934.4	4.0	6.3	34331	77039	79537	-1765	-404	3031
LM AT EARTH LAUNCH		23685.3	524.5	-3	.0	22551	24934	25052	165	430	166
SLA (EXCLUDING RING)		3961.7	634.4	1.6	-1.6	9966	12679	12450	-162	195	32
LES		9036.7	1298.1	.4	.8	832	27825	27790	63	797	1
CSM+LM+SLA+LES AT LAUNCH		111131.8	847.4	2.3	3.7	66013	1183798	1186005	3765	9618	3576
CSM+LM+SLA AT E.C.I.		102095.1	807.5	2.5	3.9	67155	724651	726908	5529	11623	3563
CSM+LM+SLA PRE TRANS/DUCK		102098.0	807.5	2.5	3.9	67155	724648	726910	5523	11612	3565
CSM AT TRANS/DUCK		64370.4	934.4	4.0	6.3	34255	76993	79505	-1772	-404	3032
LM AT TRANS/DUCK		23682.6	1236.7	-1	-3	22546	24372	24552	-458	67	233
CSM/LM (CHECKED)		98053.0	1038.2	2.6	4.1	57092	537763	540727	-8183	-9886	3416
CM EQUIP. RELOC. 1	-	510.5	1042.1	-7.3	-10.6	37	12	40	1	4	2
CM EQUIP. RELOC. 1	+	510.5	1035.4	-7.1	-12.5	39	31	46	-7	2	-4
LM-LM O2 XFR.	+	6.7	1168.7	13.0	-7.5	0	0	0	0	0	0
PRE SPS HYBRID XFR MIGN		97974.4	1038.4	2.6	4.1	57035	537452	540383	-8201	-9876	3428
POST SPS HYBRID XFR MIGN		97250.1	1038.9	2.6	4.0	56657	536299	539543	-8191	-9796	3322
CSM/LM PRE L.O.I.		97078.7	1039.1	2.6	4.0	56542	535756	539056	-8202	-9898	3358

DISPERSIONS LB/IN			
DW	DX	DY	DZ
203.1	.4	.2	.2
42.3	.4	.2	.2
50.0	.2	.1	.1
25.0	1.0	.1	.1
214.8	.3	.1	.1
213.4	.3	.1	.1
213.4	.3	.1	.1
203.1	.4	.2	.2
42.3	.4	.2	.1
207.4	.4	.1	.1
.0	.0	.0	.0
.0	.0	.0	.0
.0	.0	.0	.0
207.4	.4	.1	.1
207.4	.4	.1	.1
207.4	.4	.1	.1

U
N
I
T
E
D
S
T
A
T
E
S
O
F
A
M
E
R
I
C
A

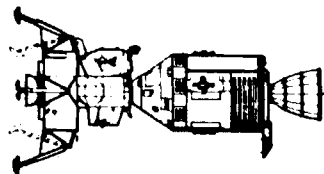

Amendment 98
1/22/71

XA COORDINATES TABLE 3.4-2 (CONTINUED)
CSM 110/LM EXPECTED SEQUENTIAL MASS PROPERTIES

DESCRIPTION	S	WEIGHT POUNDS	C. G. INCHES			INERTIAS SLUG-FT ²			PRODUCTS SLUG-FT ²		
			X	Y	Z	I _{XX}	I _{YY}	I _{ZZ}	P _{XY}	P _{XZ}	P _{YZ}
CSM/LM POST L.O.I.		72300.9	1080.9	1.4	2.7	43706	413421	420076	-5684	-5896	405
CSM/LM PRE D.O.I.		72261.5	1081.0	1.4	2.7	43671	413219	419878	-5686	-5897	414
CSM/LM POST D.O.I.		70790.7	1084.3	1.2	2.8	42925	405194	411135	-5188	-5959	322
2 CREW+EQUIP,CM-LM	-	484.0	1042.5	13.8	-10.8	19	3	20	-1	1	-1
EQUIP.XFR,LM-CM 1	+	1.1	1018.0	24.5	-15.0	0	0	0	0	0	0
CM EQUIP.RELOC.2	-	164.8	1019.3	.6	-17.2	14	16	11	0	-1	-3
CM EQUIP.RELOC.2	+	164.8	1038.3	2.3	-10.3	11	4	15	0	0	0
LANDING GEAR UP	-	488.0	1306.5	1.1	-.7	740	444	451	-2	1	-6
LANDING GEAR	+	498.0	1303.1	1.6	-.9	1921	1027	1039	-3	2	-10
2 CREW+EQUIP,CM-LM	+	484.0	1163.2	39.7	-20.9	54	41	16	1	2	23
LM EQUIP.RELOC.1	-	16.5	1154.7	45.0	-26.0	0	0	0	0	0	0
LM EQUIP.RELOC.1	+	16.5	1154.3	19.6	-22.3	1	0	1	0	0	0
EQUIP.XFR,LM-CM 1	-	1.1	1122.7	.0	-.0	0	0	0	0	0	0
CSM/LM AT SEPARATION		70604.2	1085.4	1.4	2.7	44130	405040	411076	-4808	-6222	306

DISPERSIONS LB/IN			
DW	DX	DY	DZ
207.4	.6	.2	.1
207.4	.6	.2	.1
207.4	.7	.2	.1
.0	.0	.0	.0
.0	.0	.0	.0
.0	.0	.0	.0
.0	.0	.0	.0
.0	.0	.0	.0
.0	.0	.0	.0
.0	.0	.0	.0
.0	.0	.0	.0
.0	.0	.0	.0
.0	.0	.0	.0
207.4	.7	.2	.1

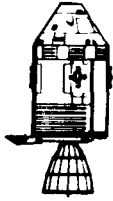

XA COORDINATES
CSM 110/LM8 EXPECTED SEQUENTIAL MASS PROPERTIES

TABLE 3.4-2 (CONTINUED)

Amendment 98
1/22/71

DESCRIPTION	S	WEIGHT POUNDS	C. G. INCHES			INERTIAS SLUG-FT ²			PRODUCTS SLUG-FT ²		
			X	Y	Z	IXX	IYY	IZZ	PXY	PXZ	PYZ
CSM PRE CIRC. RURN		36422.5	944.7	2.3	5.6	19465	57256	62766	-2007	560	102
CSM POST CIRC. RURN		36145.6	944.9	2.2	5.8	19827	57221	62600	-1993	554	86
CSM PRE PLANE CHANGE		36046.3	944.9	2.3	5.8	19735	57154	62547	-1997	557	111
CSM POST PLANE CHANGE		34777.1	946.1	1.9	6.0	19091	56915	61657	-1916	519	39
CSM AT ASCENT STAGE DOCKING		34593.3	946.2	2.0	6.0	18924	56789	61596	-1921	524	84
ASCENT STAGE AT DOCKING		5713.3	1164.2	4.8	-2.6	3291	2219	2707	-134	6	-399
CSM/ASCENT STAGE MANNED		40306.6	977.1	2.4	4.7	22302	10427	114653	-1405	-1448	-340
2 CREW+EQUIP, LM-CM	-	750.6	1164.4	24.7	-18.4	153	79	121	13	-6	7
EQUIP, XFP, CM-LM	+	283.3	1152.2	11.9	-8.1	54	96	144	47	-12	-1
LM EQUIP, RELOC.3	-	21.4	1122.7	.0	-.0	0	0	0	0	0	0
LM EQUIP, RELOC.3	+	21.4	1204.2	31.4	-40.8	0	0	0	0	0	0
2 CREW+EQUIP, LM-CM	+	750.6	1035.2	7.5	-1.9	114	91	72	14	-3	-4
EQUIP, XFP, CM-LM	-	283.3	1064.9	1.2	11.7	23	106	88	-4	-36	0
CSM/ASCENT STAGE UNMANNED		40298.0	975.1	2.1	4.9	22163	105458	110683	-1841	-1004	-289
CSM POST ASCENT STAGE JETT.		35060.6	946.9	2.1	5.7	19028	56885	61688	-1817	400	73

DISPERSIONS LB/IN			
DW	DX	DY	DZ
203.1	.6	.2	.2
203.1	.6	.2	.2
203.1	.6	.2	.2
203.1	.6	.2	.2
203.1	.6	.2	.2
27.2	.8	.1	.1
204.9	.7	.2	.2
.0	.0	.0	.0
.0	.0	.0	.0
.0	.0	.0	.0
.0	.0	.0	.0
.0	.0	.0	.0
.0	.0	.0	.0
204.9	.7	.2	.2
203.1	.6	.2	.2

U
 N
 I
 T
 E
 D
 S
 T
 A
 T
 E
 S
 O
 F
 T
 H
 E
 N
 A
 T
 I
 O
 N
 A
 L
 A
 E
 R
 O
 N
 A
 U
 T
 O
 M
 A
 T
 I
 C
 S
 Y
 S
 T
 E
 M

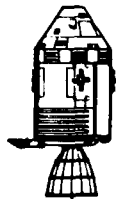

XA COORDINATES TABLE 3.4-2(Continued)
 CSM 110/LM8 EXPECTED SEQUENTIAL MASS PROPERTIES

Amendment 98
 1/22/71

DESCRIPTION	S	WEIGHT POUNDS	C. G. INCHES			INERTIAS SLUG-FT ²			PRODUCTS SLUG-FT ²		
			X	Y	Z	I _{XX}	I _{YY}	I _{ZZ}	P _{XY}	P _{XZ}	P _{YZ}
CM EQUIP. RELUC.3	-	173.1	1037.8	4.5	-13.8	16	8	17	-1	1	-2
CM EQUIP. RELUC.3	+	173.1	1020.5	5.6	-16.2	21	17	16	0	0	-5
CSM PRE T.F.I.		35008.2	946.9	2.1	5.7	18998	56752	61548	-1813	404	81
CSM POST T.F.I.		24946.8	973.8	-1.5	7.4	13800	42560	42455	45	-450	-457
CM EQUIP. RELUC.4	-	44.4	1029.7	10.1	-11.4	15	9	8	0	0	-1
CM EQUIP. RELUC.4	+	44.4	1042.7	4.8	-8.9	10	9	11	2	3	2
CSM PRE CM/SM SEPARATION		24636.1	974.4	-1.5	7.4	13546	42261	42206	30	-432	-383
SM POST CM/SM SEPARATION		11905.5	905.2	-2.8	9.2	7601	13099	13501	-462	555	-347

DISPERSIONS LB/IN			
DW	DX	DY	DZ
.0	.0	.0	.0
.0	.0	.0	.0
203.1	.6	.2	.2
203.1	1.0	.3	.2
.0	.0	.0	.0
.0	.0	.0	.0
203.1	1.1	.3	.3
196.8	1.0	.6	.5

U
S
N
A
V
Y
A
I
R
F
O
R
C
E
S
P
A
C
E
S
H
I
P
D
E
V
E
L
O
P
M
E
N
T
A
C
T
I
V
I
T
Y
R
E
P
O
R
T
N
O

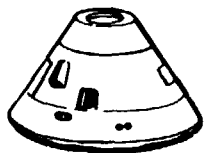

XA COORDINATES
 TABLE 3.4-2 (CONTINUED)
 CSM 110/LMR EXPECTED SEQUENTIAL MASS PROPERTIES

Amendment 98
 1/22/71

DESCRIPTION	S	WEIGHT POUNDS	C. G. INCHES			INERTIAS SLUG-FT ²			PRODUCTS SLUG-FT ²		
			X	Y	Z	I _{XX}	I _{YY}	I _{ZZ}	P _{XY}	P _{XZ}	P _{YZ}
CM POST CM/SM SEPARATION		12730.6	1039.1	-0.3	5.8	5921	5317	4767	56	-382	-24
CM AT ENTRY		12715.0	1039.1	-0.3	5.7	5914	5310	4761	56	-380	-23
ABLATOR PUFFOFF	-	150.0	1031.1	.0	7.4	103	81	76	0	0	0
ENTRY COLLING	-	2.0	1022.6	-19.7	62.5	0	0	0	0	0	0
FWD HEAT SHIELD	-	310.0	1094.3	-0.5	.8	64	26	23	0	0	0
DRGUE+DISCONNECTS	-	80.0	1089.0	.0	-23.9	1	1	0	0	0	0
CM AT MAIN CHUTE DEPLOY		12146.3	1037.5	-0.3	5.9	5710	4909	4407	56	-329	-20
PILOT CHUTE+RISERS	-	45.5	1089.9	5.9	-5.8	2	2	1	0	0	0
MAIN CHUTE	-	401.4	1089.1	.4	8.5	62	22	43	0	0	0
CM RCS DUMP	-	202.7	1022.6	-5.8	57.0	0	0	0	0	0	0
CM AT IMPACT		11496.7	1035.8	-0.2	5.0	5525	4492	4067	46	-305	-7

3.4-8

DISPERSIONS LB/IN			
DX	DR	DY	DZ
50.0	.2	.1	.1
50.0	.2	.1	.1
.0	.0	.0	.0
.0	.0	.0	.0
.0	.0	.0	.0
.0	.0	.0	.0
50.0	.2	.1	.1
.0	.0	.0	.0
.0	.0	.0	.0
.0	.0	.0	.0
50.0	.2	.1	.1

SNA-8-D-027(III)REV 2

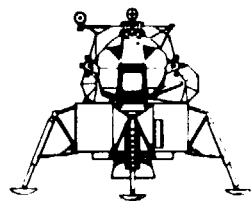

XE COORDINATES
 TABLE 3.4-3 (CONTINUED)
 LM-8 EXPECTED SEQUENTIAL MASS PROPERTIES

Amendment 98
 1/22/71

DESCRIPTION	S	WEIGHT POUNDS	C. G. INCHES			INERTIAS SLUG-FT ²			PRODUCTS SLUG-FT ²		
			X	Y	Z	IXX	IYY	IZZ	PXY	PXZ	PYZ
DESCENT ABLATION	-	29.0	145.4	.0	.0	0	0	0	0	0	0
HELIUM TRANSFER	-	48.5	144.5	47.2	-47.2	0	0	0	0	0	0
HELIUM TRANSFER	+	48.5	158.6	9.1	-8.7	0	0	0	0	0	0
LM AT TOUCHDOWN		16615.6	212.7	-0.4	1.1	12922	13980	16394	237	677	394
ASCENT STAGE AT TOUCHDOWN		10878.2	244.2	-0.1	3.1	6813	3466	5579	61	223	-4
LEFT AT LUNAR SITE	-	281.3	244.7	-11.9	24.3	44	57	44	-6	-23	1
UNLOAD AT LUNAR SITE	+	246.3	256.5	-14.6	4.1	27	39	27	0	-17	-1
LM EQUIP. RELOC. 2	-	107.1	255.4	-17.6	9.0	15	15	9	0	-6	2
LM EQUIP. RELOC. 2	+	107.1	235.0	.1	34.7	15	26	13	0	-13	0
ASCENT STAGE AT LIFTOFF		10838.2	244.2	.0	2.9	6784	3455	5965	64	215	7
A/S ABLATION	-	10.0	220.2	.0	.0	0	0	0	0	0	0
ASCENT STAGE IN ORBIT		5897.1	257.8	.1	5.3	3389	2922	2069	61	124	6

DISPERSIONS LM/IN			
DX	DY	DZ	
.0	.0	.0	.0
.0	.0	.0	.0
.0	.0	.0	.0
42.3	.5	.1	.1
27.2	.6	.2	.2
.0	.0	.0	.0
.0	.0	.0	.0
.0	.0	.0	.0
27.2	.6	.2	.2
.0	.0	.0	.0
27.2	.8	.1	.1

U
N
I
T
E
D
S
T
A
T
E
S
A
S
T
R
O
N
A
U
T
I
C
A
L
A
D
M
I
N
I
S
T
R
A
T
I
O
N

U
N
I
T
E
D
S
T
A
T
E
S
O
F
A
M
E
R
I
C
A

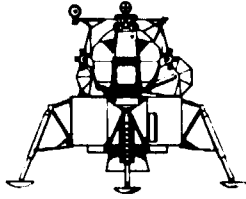

XE COORDINATES
LM-R EXPECTED SEQUENTIAL MASS PROPERTIES

TABLE 3.4-3 (CONTINUED)

Amendment 98
1/22/71

DESCRIPTION	S	WEIGHT POUNDS	C. G. INCHES			INERTIAS SLUG-FT ²			PRODUCTS SLUG-FT ²		
			X	Y	Z	IXX	IYY	IZZ	PXY	PXZ	PYZ
ASCENT STAGE PRE T.P.I.		5844.4	257.6	.1	5.3	3365	2911	2041	61	125	8
ASCENT STAGE POST T.P.I.		5787.5	257.9	.1	5.4	3326	2900	1991	61	123	8
ASCENT STAGE AT DROCKING		5713.3	257.6	.1	5.5	3291	2888	1952	61	125	11
? CREW+EQUIP, LM-CM	-	750.6	258.3	-3.6	30.6	153	104	96	-1	-14	22
EQUIP.XFER. CM-LM	+	283.3	270.6	-1.0	14.4	54	134	107	-12	-47	16
LM EQUIP. RFLOC.3	-	21.4	300.0	.0	.0	0	0	0	0	0	0
LM EQUIP. RFLOC.3	+	21.4	218.5	-19.6	47.6	0	0	0	0	0	0
ASCENT STAGE AT JETTISON		5237.4	257.8	.5	2.5	3001	2824	1967	53	91	20

DISPERSIONS LB/IN			
DW	DX	DY	DZ
27.2	.8	.1	.1
27.2	.8	.1	.1
27.2	.8	.1	.1
.0	.0	.0	.0
.0	.0	.0	.0
.0	.0	.0	.0
.0	.0	.0	.0
27.2	.9	.1	.1

N
 U
 M
 E
 R
 I
 C
 I
 D
 E
 N
 T
 I
 F
 I
 C
 A
 T
 I
 O
 N

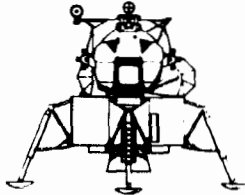

XE COORDINATES

TABLE 3.4-3 (CONTINUED)
 LM-8 EMERGENCY LUNAR LIFTOFF MASS PROPERTIES

Amendment 98
 1/22/71

DESCRIPTION	S	WEIGHT POUNDS	C. G. INCHES			INERTIAS SLUG-FT ²			PRODUCTS SLUG-FT ²		
			X	Y	Z	IXX	IYY	IZZ	PXY	PXZ	PYZ
ASCENT STAGE AT TD	+	10878.2	244.2	-0.1	3.1	6813	3466	5979	61	223	-5
PRE EVA 1 REANG.	-	214.5	243.4	-7.4	18.9	38	54	32	-7	-24	0
PRE EVA 1 REANG.	+	214.5	249.2	-1.9	21.7	27	52	26	0	-26	0
PRE EVA LNF LIFTOFF		10878.2	244.3	0.0	3.2	6803	3469	5971	67	226	-10
ASCENT STAGE AT TD	+	10878.2	244.2	-0.1	3.1	6813	3466	5979	61	223	-5
EVA 1 OFFLOAD	-	53.7	249.8	-1.9	26.4	17	12	15	0	-5	1
EVA 1 ONLOAD	+	147.1	252.7	-15.1	13.3	27	31	20	-1	-12	2
PRE EVA 2 REANG.	-	252.1	241.7	-9.0	22.6	46	59	39	-9	-25	8
PRE EVA 2 REANG.	+	252.1	246.4	-2.5	21.9	29	59	32	-1	-28	1
PRE EVA TND LIFTOFF		10971.6	244.4	-0.1	3.1	6804	3482	5981	62	218	-7

DISPERSIONS LB/IN			
DX	DY	DZ	
0.0	0.0	0.0	0.0
0.0	0.0	0.0	0.0
0.0	0.0	0.0	0.0
0.0	0.0	0.0	0.0
0.0	0.0	0.0	0.0
0.0	0.0	0.0	0.0
0.0	0.0	0.0	0.0
0.0	0.0	0.0	0.0
0.0	0.0	0.0	0.0

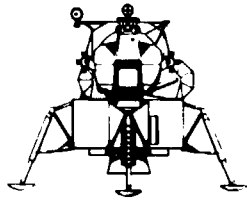

XE COORDINATES

TABLE 3.4-3 (CONTINUED)
LM-R EMERGENCY LUNAR LIFTOFF MASS PROPERTIES

Amendment 98
1/22/71

DESCRIPTION	S	WEIGHT POUNDS	C. G. INCHES			INERTIAS SLUG-FT ²			PRODUCTS SLUG-FT ²		
			X	Y	Z	I _{XX}	I _{YY}	I _{ZZ}	P _{XY}	P _{XZ}	P _{YZ}
ASCENT STAGE AT TD	+	10878.2	244.2	-0.1	3.1	6813	3466	5979	61	223	-5
EVA 1 OFFLOAD	-	53.7	249.8	-1.9	26.4	17	12	15	0	-5	1
EVA 1 ONLOAD	+	147.1	252.7	-15.1	13.3	27	31	20	-1	-12	2
EVA 2 OFFLOAD	-	94.7	241.5	-8.2	29.5	17	17	18	-3	-6	0
EVA 2 ONLOAD	+	145.6	257.2	-5.9	5.0	19	27	24	-4	-12	6
PPL DEPRESSURE ARG	-	198.3	244.4	-8.7	17.0	36	50	29	-7	-23	10
PWE DEPRESSURE ARG	+	198.3	238.7	-2.1	24.7	15	31	17	-1	-14	0
PAL DEPRESS LIFTOFF		11036.5*	244.4	-0.2	3.2	6812	2439	5985	56	214	-4

DISPERSIONS LB/IN			
DW	DX	DY	DZ
.0	.0	.0	.0
.0	.0	.0	.0
.0	.0	.0	.0
.0	.0	.0	.0
.0	.0	.0	.0
.0	.0	.0	.0
.0	.0	.0	.0
.0	.0	.0	.0
.0	.0	.0	.0
.0	.0	.0	.0
.0	.0	.0	.0
.0	.0	.0	.0
.0	.0	.0	.0
.0	.0	.0	.0
.0	.0	.0	.0
.0	.0	.0	.0
.0	.0	.0	.0
.0	.0	.0	.0
.0	.0	.0	.0
.0	.0	.0	.0
.0	.0	.0	.0

* Does not reflect 5.0 pounds of LM-RCS usage at liftoff.

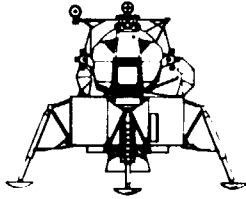

XE COORDINATES

TABLE 3.4-3 (CONTINUED)
LM-8 EMERGENCY LUNAR LIFTOFF MASS PROPERTIES

Amendment 98
1/22/71

DESCRIPTION	S	WEIGHT POUNDS	C. G. INCHES			INERTIAS SLUG-FT ²			PRODUCTS SLUG-FT ²		
			X	Y	Z	IXX	IYY	IZZ	PXY	PXZ	PYZ
ASCENT STAGE AT TD	+	10878.2	244.2	-0.1	3.1	6913	2466	5979	61	223	-5
LM EQUIP. RELIC. 2	-	107.1	255.4	-17.6	9.0	15	19	9	0	-6	2
LM EQUIP. RELIC. 2	+	107.1	235.0	.1	34.7	15	26	13	0	-13	0
EVA 1 UNFLCAD	-	53.7	249.8	-1.9	26.4	17	12	15	0	-5	1
EVA 1 UNLCAD	+	147.1	252.7	-15.1	13.3	27	31	20	-1	-12	2
EVA 2 OFFLOAD	-	84.7	241.5	-8.2	25.5	17	17	18	-3	-6	0
EVA 2 UNLCAD	+	145.6	257.2	-5.9	5.0	19	27	24	-4	-12	6
FINAL UNFLCAD	-	193.3	244.9	-10.6	24.8	21	38	25	-8	-17	5
MINIMAL LIFTOFF		10843.2*	244.2	0.0	2.9	6785	3456	5969	64	214	6

DISPERSIONS LB/IN			
DW	DX	DY	DZ
.0	.0	.0	.0
.0	.0	.0	.0
.0	.0	.0	.0
.0	.0	.0	.0
.0	.0	.0	.0
.0	.0	.0	.0
.0	.0	.0	.0
.0	.0	.0	.0
.0	.0	.0	.0
.0	.0	.0	.0
.0	.0	.0	.0
.0	.0	.0	.0
.0	.0	.0	.0
.0	.0	.0	.0
.0	.0	.0	.0

3.4-14

* Does not reflect 5.0 pounds of LM-RCS usage at liftoff.

U
N
I
T
E
D
S
T
A
T
E
S



Amendment 97
1/05/71

XA COORDINATES
TABLE 3.4-4
CSM 110 LEV DETAIL (TILTED) MASS PROPERTIES HIGH ALTITUDE ABORT

DESCRIPTION	S	WEIGHT POUNDS	C. G. INCHES			INERTIAS SLUG-FT2			PRODUCTS SLUG-FT2			DISPERSIONS LB/IN			
			X	Y	Z	Ixx	Iyy	Izz	Pxy	Pxz	Pyz	Dx	Dy	Dz	
TIME = 0.0		21670.0	1144.2	-.0	3.6	6697	108440	107875	329	-1050	-24	.0	.0	.0	.0
0.5		21311.2	1145.7	-.0	3.7	6692	106501	105936	324	-1026	-24	.0	.0	.0	.0
1.0		20886.2	1142.7	-.1	3.7	6685	104254	103689	319	-997	-23	.0	.0	.0	.0
1.5		20436.2	1139.3	-.1	3.8	6676	101780	101215	313	-965	-23	.0	.0	.0	.0
2.0		20051.2	1136.3	-.1	3.8	6668	99580	99016	307	-936	-23	.0	.0	.0	.0
2.5		19666.2	1133.2	-.1	3.8	6658	97300	96736	302	-908	-23	.0	.0	.0	.0
3.0		19301.2	1130.2	-.1	3.9	6647	95059	94496	297	-876	-23	.0	.0	.0	.0
3.5		19021.2	1127.8	-.1	3.9	6639	93285	92723	292	-853	-23	.0	.0	.0	.0
4.0		18841.2	1126.2	-.1	4.0	6633	92118	91556	289	-837	-23	.0	.0	.0	.0
4.5		18721.2	1125.1	-.1	4.0	6629	91329	90767	288	-826	-23	.0	.0	.0	.0
5.0		18651.2	1124.4	-.1	4.0	6626	90864	90302	286	-820	-23	.0	.0	.0	.0
5.5		18581.2	1123.8	-.1	4.0	6624	90395	89834	285	-814	-23	.0	.0	.0	.0
6.0		18546.2	1123.5	-.1	4.0	6623	90160	89599	285	-811	-23	.0	.0	.0	.0
6.5		18520.2	1123.3	-.1	4.0	6622	90039	89477	285	-809	-23	.0	.0	.0	.0
7.0		18511.2	1123.2	-.1	4.0	6621	89924	89362	284	-808	-23	.0	.0	.0	.0
7.5		18493.2	1123.0	-.1	4.0	6621	89802	89241	284	-806	-23	.0	.0	.0	.0

U
 N
 I
 T
 E
 D
 S
 T
 A
 T
 E
 S
 A
 R
 M
 Y
 A
 I
 R
 F
 O
 R
 C
 E
 S
 S
 E
 S
 S
 I
 O
 N
 S



Amendment 97
1/05/71

KA COORDINATES
 TABLE 3.4-4 (CONTINUED)
 CS4 110 LEV DETAIL (TILTED) MASS PROPERTIES HIGH ALTITUDE ABORT

DESCRIPTION	S	WEIGHT POUNDS	C. G. INCHES			INERTIAS SLUG-FT ²			PRODUCTS SLUG-FT ²			DISPERSIONS -9/IN			
			X	Y	Z	I _{XX}	I _{YY}	I _{ZZ}	P _{XY}	P _{XZ}	P _{YZ}	GM	GM	GM	GM
TIME = 8.0		18475.2	1122.8	-0.1	4.0	6620	99680	89119	284	-804	-23	.0	.0	.0	.0
9.0		18465.2	1122.7	-0.1	4.0	6620	89612	89051	283	-803	-23	.0	.0	.0	.0
CM W/O DRK.MECH.	+	12434.8	1039.9	-0.4	5.7	5833	5194	4691	49	-397	-21	.0	.0	.0	.0
FWD. HEAT SHIELD	-	310.0	1094.3	-0.5	.8	64	26	23	0	0	0	.0	.0	.0	.0
CM W/O DRK.MECH.HEAT SHLD		12124.8	1038.5	-0.4	5.9	5768	4963	4465	50	-374	-21	.0	.0	.0	.0
DRUGUE+DISCONNECTS	-	80.0	1049.0	.0	-23.9	1	1	0	0	0	0	.0	.0	.0	.0
CM AT MAIN CHUTE DEPLOY		12044.8	1038.2	-0.4	6.1	5751	4902	4420	50	-353	-20	.0	.0	.0	.0
PILOT CHUTE+RISERS	-	45.5	1089.9	5.9	-5.8	2	2	1	0	0	0	.0	.0	.0	.0
MAIN CHUTE PACKS	-	401.4	1089.1	.4	8.5	62	22	43	0	0	0	.0	.0	.0	.0
RCS OXID SYSTEM A	-	77.3	1022.6	26.6	59.8	1	0	1	0	0	0	.0	.0	.0	.0
RCS OXID SYSTEM B	-	77.3	1022.6	2.3	65.5	1	0	1	0	0	0	.0	.0	.0	.0
RCS FUEL SYSTEM A	-	43.7	1022.6	-38.7	52.8	0	0	0	0	0	0	.0	.0	.0	.0
RCS FUEL SYSTEM B	-	43.7	1022.6	-52.8	38.7	0	0	0	0	0	0	.0	.0	.0	.0
CM AT IMPACT		11355.9	1036.5	-0.3	5.8	5490	4465	4051	38	-321	-13	.0	.0	.0	.0

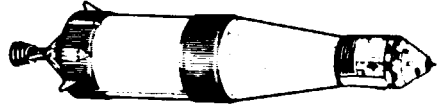

LV COORDINATES
S-IVB EXPECTED SEQUENTIAL MASS PROPERTIES

Amendment 98
1/22/71

DESCRIPTION	S	WEIGHT POUNDS	C. G. INCHES			INERTIAS SLUG-FT ²					
			X	Y	Z	IXX	IYY	IZZ			
S-IVB POST F.O.I.		202283.0	2834.3	1.0	-0.8	89930	956807	953391			
CSM		64448.1	3691.0	4.0	6.3	34331	77039	79537			
LM (IN SLA)		33685.3	3341.0	-0.3	.0	22551	24934	25052			
S-IVB+CSM+LM POST F.O.I.		300416.4	3074.9	1.5	.8	147472	9381697	9380475			
S-IVB PRE T.L.I.		199952.0	2831.8	1.0	-0.8	89289	932724	929535			
CSM PRE T.L.I.		64441.0	3691.0	4.0	6.3	34331	77039	79537			
LM (IN SLA)		33685.3	3341.0	-0.3	.0	22551	24934	25052			
S-IVB+CSM+LM PRE T.L.I.		298078.3	3075.1	1.5	.8	146828	9380290	9379302			
S-IVB POST T.L.I.		42238.0	2932.6	4.4	-3.7	88693	617383	613869			
CSM POST T.L.I.		64441.0	3691.0	4.0	6.3	34331	77039	79537			
LM (IN SLA)		33685.3	3341.0	-0.3	.0	22551	24934	25052			
S-IVB+CSM+LM POST T.L.I.		140364.3	3378.8	3.1	1.8	146266	3900537	3900165			
S-IVB (EXCL. SLA PANELS)		39298.0	2901.0	4.7	-3.7	82403	456287	453154			
LM (IN SLA)		33685.3	3341.0	-0.3	.0	22551	24934	25052			
S-IVB+LM PRE DICKING		72983.3	3104.1	2.4	-2.0	105106	1239399	1236431			

NOTE: Products of inertia are not presently available for the S-IVB. This table will be updated to include products of inertia when data is available.

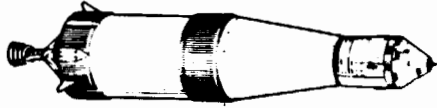

XA COORDINATES

TABLE 3.4-6 (CONTINUED)

Amendment 98
1/22/71

SIVB EXPECTED SEQUENTIAL MASS PROPERTIES

DESCRIPTION	S	WEIGHT POUNDS	C. G. INCHES			INERTIAS SLUG-FT ²					
			X	Y	Z	I _{XX}	I _{YY}	I _{ZZ}			
SIVB (EXCL. SLA PANELS)		39298.0	1677.9	-0.8	5.9	82403	453877	455566			
CSM AT TRANS/DOCK		64370.4	934.4	4.0	6.3	34255	76992	76505			
LA AT TRANS/DOCK		33682.6	1236.7	-0.1	-0.3	22546	24372	24952			
CSM/LM/SIVB DOCKED		137351.0	1221.2	1.6	4.6	139583	3468868	3473569			
CSM/LM DOCKED		98053.0	1038.2	2.6	4.0	57089	527726	540691			

NOTE: Products of inertia are not presently available for the S-IVB. This table will be updated to include products of inertia when data is available.

TABLE 3.4-7

CSM 110 Consumables Weight Change Summary
(To be used in conjunction with the CSM sequential mass properties Table 3.4-2)

From	EVENT To	Consumable	Weight Change (Pounds)	Amount Remaining (Pounds)	Total Usage (Pounds)
Earth Launch	Pre Trans/Dock	SM-Hydrogen	-0.5	54.7	-0.5
		SM-Oxygen	-11.4	819.9	-11.4
		CM-Potable	+4.0	40.0	
		CM-Waste	+0.8	18.8	
Pre Trans/Dock	Post Trans/Dock	SM-RCS	-70.6	1270.0	-70.6
Post Trans/Dock	Pre SPS Hybrid	SM-Hydrogen	-4.9	49.8	-5.4
		SM-Oxygen	-54.3	765.6	-65.7
		SM-RCS	-70.3	1199.7	-140.9
		CM-Waste H ₂ O	+41.2	60.0	
		CM-LiOH	+6.8	6.8	
		CM-Food	-3.8		-3.8
Pre SPS Hybrid	Post SPS Hybrid	SM-SPS	-724.3	39829.6	724.3
Post SPS Hybrid	Pre L.O.I.	SM-Hydrogen	-9.4	40.4	-14.8
		SM-Oxygen	-93.9	671.7	-159.6
		SM-RCS	-65.5	1134.2	-206.4
		CM-Food	-9.4		-13.2
		CM-LiOH	+6.8	13.6	
Pre L.O.I.	Post L.O.I.	SM-SPS	-24777.8	15051.8	25502.1
Post L.O.I.	Pre D.O.I.	SM-Hydrogen	-0.5	39.9	-15.3
		SM-Oxygen	-8.5	663.2	-168.1
		SM-RCS	-30.4	1103.8	-236.8
Pre D.O.I.	Post D.O.I.	SM-SPS	-1470.8	13581.0	26972.9
Post D.O.I.	CSM/LM Separation	SM-Hydrogen	-3.4	36.5	-18.7
		SM-Oxygen	-31.2	632.0	-199.3
		SM-RCS	-134.0	969.8	-370.8
		CM-LiOH	+5.0	18.6	
		CM-Food	-3.8		-17.0
CSM/LM Separation	Pre Circular- ization	SM-Hydrogen	-0.3	36.2	-19.0
		SM-Oxygen	-2.0	630.0	-201.3
		SM-RCS	-26.3	943.5	-397.1
Pre Circular- ization	Post Circular- ization	SM-SPS	-272.9	13308.1	27245.8



TABLE 3.4-7 (CONTINUED)

CSM 110 Consumables Weight Change Summary
(To be used in conjunction with the CSM sequential mass properties Table 3.4-2)

EVENT		Consumable	Weight Change (Pounds)	Amount Remaining (Pounds)	Total Usage (Pounds)
From	To				
Post Circular- ization	Pre Plane Change	SM-Hydrogen	-2.4	33.8	-21.4
		SM-Oxygen	-25.1	604.9	-226.4
		SM-RCS	-75.8	867.7	-472.9
Pre Plane Change	Post Plane Change	SM-SPS	-1269.2	12038.9	28515.0
Post Plane Change	CSM/ASCT Docking	SM-Hydrogen	-4.9	28.9	-26.3
		SM-Oxygen	-47.4	557.5	-273.8
		SM-RCS	-135.2	732.5	-608.1
		CM-Food	-6.3		-23.3
		CM-LiOH	+7.8	26.4	
		CM-Fecal	+2.2	2.2	
CSM/ASCT Docking	Pre T.E.I.	SM-Hydrogen	-1.1	27.8	-27.4
		SM-Oxygen	-9.3	548.2	-283.1
		SM-RCS	-41.9	690.6	-650.0
		CM-Fecal	+1.1	3.3	
		CM-Food	-3.8		-27.1
		CM-LiOH	+2.6	29.0	
Pre T.E.I.	Post T.E.I.	SM-SPS	-10059.4	1979.5	38574.4
Post T.E.I.	SM Jettison	SM-Hydrogen	-11.8	16.0	-39.2
		SM-Oxygen	-127.3	420.9	-410.4
		SM-RCS	-179.9	510.7	-829.9
		CM-LiOH	+13.4	42.4	
		CM-Food	-10.4		-37.5
		CM-Fecal	+3.3	6.6	
SM Jettison	CM @ Entry	CM-RCS	-11.6	233.4	-11.6
CM @ Entry	CM @ M.C. Deploy	CM-RCS	-30.7	202.7	-42.3
CM @ M.C. Deploy	CM @ Impact	CM-RCS	-202.7	0.0	-245.0

U U U E E E L L E E E E H U E E L L

TABLE 3.4-8

LM-8 Consumables Change Summary
To be used in conjunction with the LM sequential mass properties Table 3.4-2)

From	EVENT	To	Consumable	Weight Change (Pounds)	Amount Remaining (Pounds)	Total Usage (Pounds)
Earth Orbit		CSM/LM Separation	D/S-Oxygen	-1.1	46.9	-1.1
			D/S-Water	-13.0	237.0	-13.0
			LM-RCS	-5.0	600.0	-5.0
CSM/LM Separation		Pre P.D.I.	D/S-Oxygen	-1.0	45.9	-2.1
			D/S-Water	-21.3	215.7	-34.3
			LM-RCS	-55.5	545.1	-60.5
Pre P.D.I.		LM @ Touchdown	D/S-Oxygen	-0.1	45.8	-2.2
			D/S-Water	-1.1	214.6	-35.4
			LM-RCS	-97.0	448.1	-157.5
			LM-DPS	17,332.5	989.1	17,332.5
A/S @ Touchdown		A/S at Lift-Off	LM-RCS	-5.0	443.1	-162.5
A/S @ Lift-Off		A/S in Orbit	LM-APS	4931.1	279.9	4931.1
A/S in Orbit		Pre T.P.I.	A/S-Water	-5.0	80.0	-5.0
			A/S-Oxygen	-0.3	4.5	-0.3
			LM-RCS	-47.4	395.7	209.9
Pre T.P.I.		Post T.P.I.	LM-APS	56.9	223.0	4988.0
A/S @ Post T.P.I.		A/S @ Docking	A/S-Water	-3.8	76.2	-8.8
			A/S-Oxygen	-0.2	4.3	-0.5
			LM-RCS	70.2	325.5	-280.1
A/S @ Docking		A/S Jettison	A/S-Water	-8.2	68.0	-17.0
			A/S-Oxygen	-0.4	3.9	-0.9

NOTE:

Tanked LM RCS Propellant should be reduced by 0.3 lb fuel and 0.7 lb oxidizer.



1/22/71

REFERENCE CODE EXPLANATION

The reference table used with this Transferable Equipment List is a directory of information sources from which data for each item were obtained. It is intended to define the exact source for each portion of the data used. This reference table is correlated to each item in the Transferable Equipment List by a 3-digit reference code number.

The code is the form

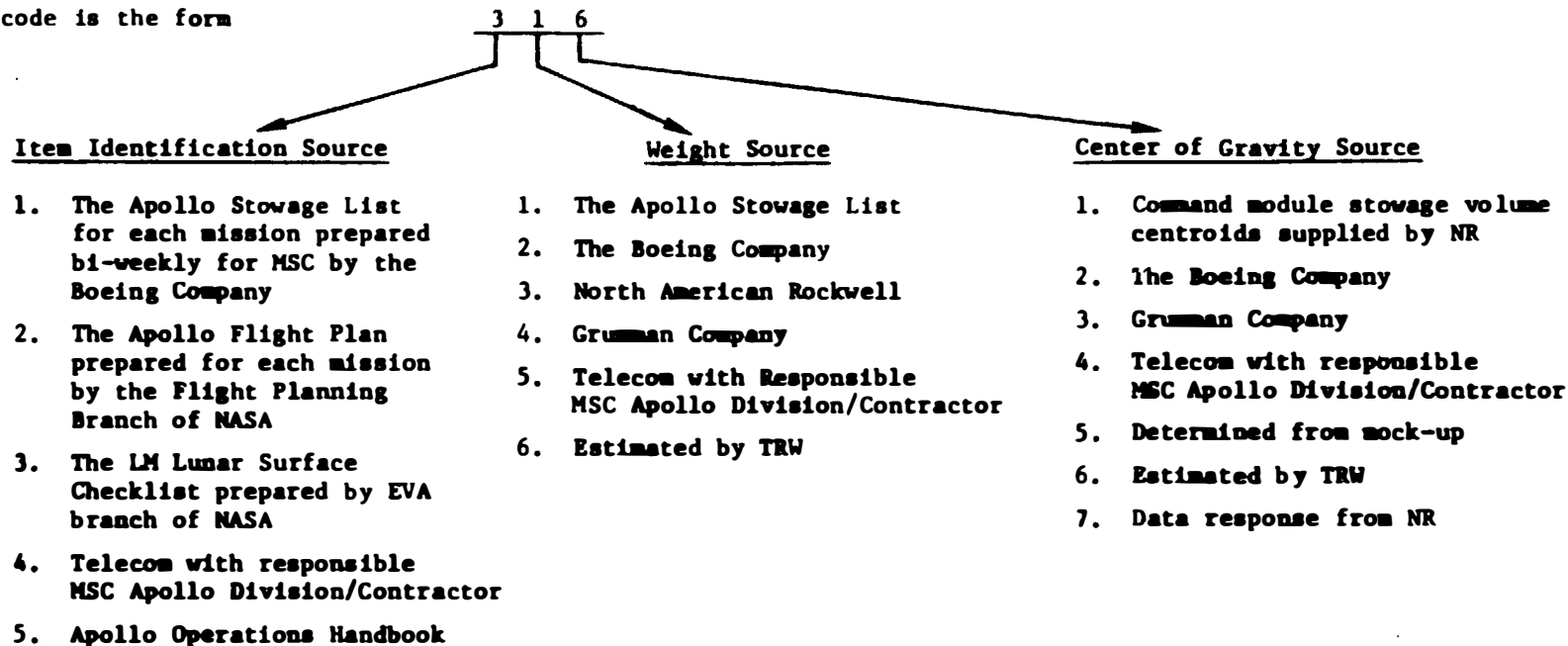

TABLE 3.4-9
MISSION H COMMAND MODULE STOWAGE VOLUME CENTROIDS
S/C 109 - 111

<u>AREA</u>	<u>X</u>	<u>Y</u>	<u>Z</u>
A1	1012.0	-22.0	-26.0
3	1016.0	-24.0	28.0
4	1015.0	- 7.0	28.0
5	1015.0	9.0	28.0
6	1017.0	26.0	28.0
7 - Not on S/C 110	1012.0	31.0	7.0
8	1012.0	22.0	-23.0
10 - S/C 110 Only	1011.0	23.0	6.0
11 - Not on S/C 110	1011.0	19.0	7.0
12	1013.0	- 9.0	14.0
13	1010.0	-22.0	- 2.0
B1	1050.0	-27.0	39.0
2	1039.0	-38.0	37.0
3	1031.0	-28.0	40.0
4	1031.0	-20.0	40.0
5	1031.0	- 8.0	39.0
6	1031.0	13.0	39.0
7	1033.0	27.0	36.0
8	1024.0	-38.0	37.0
L2	1059.0	-44.0	14.0
3	1048.0	-47.0	12.0
R1	1072.0	26.0	21.0
2	1072.0	26.0	14.0
3	1072.0	26.0	9.0
4	1075.0	28.0	3.0
5	1059.0	44.0	15.0
6	1048.0	46.0	29.0
8	1052.0	46.0	12.0
10 - Forward	1053.0	47.0	5.0
10 - Aft	1047.0	48.0	5.0
11	1038.0	47.0	26.0
13	1024.0	45.0	-26.0
U1	1033.0	23.0	-50.0
3	1033.0	-36.0	-44.0
4	1038.0	39.0	-43.0



Table 3.4-9.1

The following storage locations have unique volume centroids not associated with storage volumes.

<u>NOMENCLATURE</u>	<u>LOCATION</u>	<u>X</u>	<u>Y</u>	<u>Z</u>
G&N Signal Cond. Panel	LEB	1069.0	25.0	29.0
Display Keyboard	LEB	1060.0	26.0	32.0
Sleep Restraint Assy - Right	Aft UEB	1020.0	25.0	-22.0
Sleep Restraint Assy - Left	Aft UEB	1018.0	-21.0	-49.9
Food Container	L3	1048.0	-47.0	12.0
Food Container	B1	1050.0	-27.0	39.0
Personal Storage Container	RHEB	1039.0	47.0	12.0
PGA Container	On Aft Bulkhead Under Center Couch	1011.0	0.0	-14.0
Forward Hatch Container	Under L.H. Couch	1018.0	-24.5	-15.0
Container, R12 (In-flight Location)	R.H. Girth Ring	1036.5	40.0	-25.0
Helmet Storage and Accessory Bag (In-flight Location) - L.H.	L.H. Girth Ring	1036.5	-40.0	-25.0
Helmet Storage and Accessory Bags (In-flight Location) - Ctr.	LEB	1050.0	-27.0	39.0
Helmet Storage and Accessory Bags (In-flight Location) - R.H.	R.H. Girth Ring	1036.5	40.0	-25.0
Temporary Storage Bag - L.H. (In-flight Location)	LHEB	1039.0	-47.0	12.0
Temporary Storage Bag - Ctr. (In-flight Location)	LEB	1050.0	-27.0	39.0
Temporary Storage Bag - R.H. (In-flight Location)	RHEB	1039.0	47.0	12.0
CO ₂ Absorbers (2)	In ECU	1031.0	-48.3	19.6
CO ₂ Absorbers (4)	A3	1016.0	-24.0	28.0
CO ₂ Absorbers (4)	A4	1015.0	-7.0	28.0
CO ₂ Absorbers (2)	A6	1017.0	26.0	28.0
CO ₂ Absorbers (4)	B5	1031.0	-8.0	39.0
CO ₂ Absorbers (4)	B6	1031.0	13.0	39.0
	Composite Location used in Sequential Mass Properties Tables For CO ₂ Absorbed.			
First 6.8 lb. CO ₂ Absorbed	B5	1031.0	-8.0	39.0
Next 6.8 lb. CO ₂ Absorbed	B6	1031.0	13.0	39.0
Remainder CO ₂ Absorbed	Composite Location	1018.5	-14.3	26.1

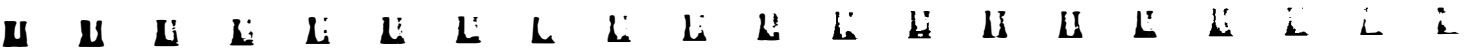

Table 3.4-9.2

MISSION H-3 TRANSFERRED CREW AND EQUIPMENT STOWAGE LIST								
ITEMS REARRANGED IN CM PRIOR TO FIRST MID-COURSE CORRECTION (1)								
APOLLO COORDINATES								
DESCRIPTION	STOW. ITEM	REF	NO.	STOWAGE LOCATION	WEIGHT	X-C.G.	Y-C.G.	Z-C.G.
CREW-COMMAND MIDDLE PILOT(CMP)	TBC	227	1	ON COUCH(CTR CRW STA	161.0	1043.0	.0	-10.4
CREW-COMMANDER (CDR)	THC	227	1	ON COUCH(LH CREW STA	171.0	1043.0	-24.5	-10.4
TUN SU+LIME SUIT ASSY, IV-CMP.	R0201.1	127	1	ON CREW-CMP(CTR STA)	30.3	1043.0	.0	-10.4
HELMET ASSY, PRESSURE-CMP.	R0201.2	127	1	ON CREW-CMP(CTR STA)	2.5	1043.0	.0	-10.4
GLOVES, IV(PAIR)-CMP.	R0201.3	127	1	ON CREW-CMP(CTR STA)	1.7	1043.0	.0	-10.4
COMMUNICATIONS CARRIER-CMP.	R0201.4	127	1	ON CREW-CMP(CTR STA)	1.6	1043.0	.0	-10.4
PULKLT, CHECKLIST+SCISSORS-CMP.	R0201.5	167	1	ON CREW-CMP(CTR STA)	.2	1043.0	.0	-10.4
PULKLT, CHECKLIST-CMP	R0201.6	167	1	ON CREW-CMP(CTR STA)	.2	1043.0	.0	-10.4
VEST, DUAL LIFE-CMP.	R0202.	111	1	ON CREW-CMP(CTR STA)	2.4	1043.0	.0	-10.4
BAG, MOTION SICKNESS-CMP.	A0208.	111	1	ON PGA(CREW-CTR STA)	.1	1043.0	.0	-10.4
JCIA-CMP.	R0205.	117	1	ON CREW-CMP(CTR STA)	.5	1043.0	.0	-10.4
T-ADAPTER, CWG-CMP.	R0135.	111	1	IN ADAPTER BAG (AP)	.4	1012.0	22.0	-23.0
JACKET ASSY, ICG-CMP.	R0112.1	111	1	IN CM PGA CONTAINER	1.8	1011.0	.0	-14.0
THROUSE ASSY, ICG-CMP.	H0112.2	111	1	IN CM PGA CONTAINER	1.8	1011.0	.0	-14.0
SOFT, RIGHT, ICG-CMP.	R0112.3	111	1	IN CM PGA CONTAINER	.4	1011.0	.0	-14.0
SOFT, LEFT, ICG-CMP.	R0112.4	111	1	IN CM PGA CONTAINER	.4	1011.0	.0	-14.0
EARTUBE, UNIVERSAL-CMP.	E0105.1	111	1	ON ICG (PGA CONTAIN)	NFGL	1011.0	.0	-14.0
BULB+STIMULATION-CMP.	C0201.	111	1	ON CREW-CMP(CTR STA)	1.1	1043.0	.0	-10.4
HEMDEET, LIGHTWEIGHT-CMP.	E0104.	111	1	AREA A8	.4	1012.0	22.0	-23.0
TUN SU+LIME SUIT ASSY, EV-CDR.	R0200.1	127	1	ON CREW-CDR(LH STA)	38.6	1043.0	-24.5	-10.4
HELMET ASSY, PRESSURE-CDR.	R0200.2	127	1	ON CREW-CDR(LH STA)	2.5	1043.0	-24.5	-10.4
GLOVES, IV(PAIR)-CDR.	R0200.3	127	1	ON CREW-CDR(LH STA)	1.6	1043.0	-24.5	-10.4
COMMUNICATIONS CARRIER-CDR.	R0200.4	127	1	ON CREW-CDR(LH STA)	1.6	1043.0	-24.5	-10.4
PULKLT, CHECKLIST+SCISSORS-CDR.	R0200.5	167	1	ON CREW-CDR(LH STA)	.2	1043.0	-24.5	-10.4
PULKLT, CHECKLIST-CDR.	R0200.6	167	1	ON CREW-CDR(LH STA)	.2	1043.0	-24.5	-10.4
BAG, MOTION SICKNESS-CDR.	A0208.	111	1	ON PGA (CREW-LH STA)	.1	1043.0	-24.5	-10.4
JCIA-CDR.	R0205.	117	1	ON CREW-CDR(LH STA)	.5	1043.0	-24.5	-10.4
T-ADAPTER, CWG-CDR.	R0135.	111	1	IN ADAPTER BAG (AP)	.4	1012.0	22.0	-23.0
JACKET ASSY, ICG-CDR.	R0112.1	111	1	IN CM PGA CONTAINER	1.8	1011.0	.0	-14.0
THROUSE ASSY, ICG-CDR.	H0112.2	111	1	IN CM PGA CONTAINER	1.8	1011.0	.0	-14.0
SOFT, RIGHT, ICG-CDR.	R0112.3	111	1	IN CM PGA CONTAINER	.4	1011.0	.0	-14.0
SOFT, LEFT, ICG-CDR.	R0112.4	111	1	IN CM PGA CONTAINER	.4	1011.0	.0	-14.0

NOTE: Further information relating to this table is given on pages 3.4-19, 3.4-20 and 3.4-21.

Table 3.4-9.2 (Continued)

MISSION H-3 TRANSFERRED CREW AND EQUIPMENT STOWAGE LIST								
ITEMS REARRANGED IN CM PRIOR TO FIRST MID-COURSE CORRECTION (1)								
APULLO COORDINATES								
DESCRIPTION	STOW. ITEM	REF	NO.	STOWAGE LOCATION	WEIGHT	X-C.G.	Y-C.G.	Z-C.G.
EARTUBE, UNIVERSAL-CDR.	E0105.	111	1	ON ICG (PGA CONTAIN)	NEGL	1011.0	.0	-14.0
BIG INSTRUMENTATION-CDR.	C0201.	111	1	ON CREW-CDR(LH STA)	1.1	1043.0	-24.5	-10.4
HEADSET, LIGHTWEIGHT-CDR.	E0104.	111	1	AREA A8	.4	1012.0	22.0	-23.0
EARPIECE, MOLDED (COMM. CARR.)-CDR.	E0200.1	111	1	ON CREW-CDR(LH STA)	NEGL	1043.0	-24.5	-10.4
EARTUBE (COMM. CARRIER)-CDR.	E0200.2	111	1	ON CREW-CDR(LH STA)	NEGL	1043.0	-24.5	-10.4
TUN SU+LIMP SUIT ASSY, FV-LMP.	E0200.1	127	1	ON CREW-LMP(RH STA)	38.6	1043.0	24.5	-10.4
HELMET ASSY, PRESURE-LMP.	R0200.2	127	1	ON CREW-LMP(RH STA)	2.5	1043.0	24.5	-10.4
GLOVES, IV (PAIR)-LMP.	R0200.7	127	1	ON CREW-LMP(RH STA)	1.8	1043.0	24.5	-10.4
COMMUNICATIONS CARRIER-LMP.	R0200.4	127	1	ON CREW-LMP(RH STA)	1.6	1043.0	24.5	-10.4
POCKET, CHECKLIST+SCISSORS-LMP.	R0200.5	167	1	ON CREW-LMP(RH STA)	.2	1043.0	24.5	-10.4
POCKET, CHECKLIST-LMP.	R0200.6	167	1	ON CREW-LMP(RH STA)	.2	1043.0	24.5	-10.4
VEST, DUAL LIFE-LMP.	R0202.	111	1	ON CREW-LMP(RH STA)	2.4	1043.0	24.5	-10.4
BAG, MOTION SICKNESS-LMP.	A0208.	111	1	ON PGA (CREW-RH STA)	.1	1043.0	24.5	-10.4
UTA-LMP.	R0205.	117	1	ON CREW-LMP(RH STA)	.5	1043.0	24.5	-10.4
T-ADAPTER, CWG-LMP.	B0135.	111	1	IN ADAPTER BAG (A8)	.4	1012.0	22.0	-23.0
JACKET ASSY, ICG-LMP.	R0112.1	111	1	IN CM PGA CONTAINER	1.8	1011.0	.0	-14.0
TRUSER ASSY, ICG-LMP.	R0112.2	111	1	IN CM PGA CONTAINER	1.8	1011.0	.0	-14.0
BOUT, RIGHT, ICG-LMP.	R0112.3	111	1	IN CM PGA CONTAINER	.4	1011.0	.0	-14.0
BOUT, LEFT, ICG-LMP.	R0112.4	111	1	IN CM PGA CONTAINER	.4	1011.0	.0	-14.0
EARTUBE, UNIVERSAL-LMP.	E0105.	111	1	ON ICG (PGA CONTAIN)	NEGL	1011.0	.0	-14.0
HEADSET, LIGHTWEIGHT-LMP.	E0104.	111	1	AREA A8	.4	1012.0	22.0	-23.0
EARPIECE, MOLDED (COMM. CARR.)-LMP.	E0200.1	111	1	ON CREW-LMP(RH STA)	NEGL	1043.0	24.5	-10.4
EARTUBE (COMM. CARRIER)-LMP.	E0200.2	111	1	ON CREW-LMP(RH STA)	NEGL	1043.0	24.5	-10.4
BAG, HELMET STOW, INFLIGHT-CMP.	B0105.	115	1	AREA R6	.6	1048.0	46.0	29.0
BAG, HELMET STOW, INFLIGHT-CDR.	B0105.	115	1	AREA R6	.6	1048.0	46.0	29.0
BAG, HELMET STOW, INFLIGHT-LMP.	B0105.	115	1	AREA R6	.6	1048.0	46.0	29.0
BAG, ACCESSORY-CMP.	B0105.1	115	1	HELMET STOW BAG (R6)	.3	1048.0	46.0	29.0
BAG, ACCESSORY-CDR.	B0105.1	115	1	HELMET STOW BAG (R6)	.3	1048.0	46.0	29.0
BAG, ACCESSORY-LMP.	B0105.1	115	1	HELMET STOW BAG (R6)	.3	1048.0	46.0	29.0
CONTAINER, TEMP. STOW-CMP.	C0301.	115	1	AREA A1	1.7	1012.0	-22.0	-26.0
CONTAINER, TEMP. STOW-CDR.	C0301.	115	1	AREA A1	1.7	1012.0	-22.0	-26.0
CONTAINER, TEMP. STOW-LMP.	C0301.	115	1	AREA A1	1.7	1012.0	-22.0	-26.0

NOTE: Further information relating to this table is given on pages 3.4-19, 3.4-20 and 3.4-21.

Table 3.4-9.2 (Continued)

MISSION H-3 TRANSFERRED CREW AND EQUIPMENT STOWAGE LIST								
ITEMS REARRANGED IN CM PRIOR TO FIRST MID-COURSE CORRECTION (1)								
DESCRIPTION	STOW. ITEM	PFF	NO.	STOWAGE LOCATION	WFIGHT	APOLLO COORDINATES		
						X-C.G.	Y-C.G.	Z-C.G.
CONTAINER #12	G0344	115	1	AWFA R3	2.7	1072.0	26.0	9.0
CSM LAUNCH CHECKLIST	A0114.1	164	2	IN FDF (R12/IN R3)	1.0	1072.0	26.0	9.0
CSM G/C CHECKLIST	A0114.2	164	1	IN FDF (R12/IN R3)	1.0	1072.0	26.0	9.0
CSM SYSTEM CHECKLIST	A0114.3	164	1	IN FDF (R12/IN R3)	1.0	1072.0	26.0	9.0
CSM LUNAR LANDMARK MAP	A0114.5	164	1	IN FDF (R12/IN R3)	.6	1072.0	26.0	9.0
CSM DATA SYSTEMS	A0114.7	164	1	IN FDF (R12/IN R3)	.9	1072.0	26.0	9.0
CSM MALFUNCTIONS PROCEDURES	A0114.8	164	1	IN FDF (R12/IN R3)	.6	1072.0	26.0	9.0
FLIGHT PLAN	A0114.9	164	1	IN FDF (R12/IN R3)	3.0	1072.0	26.0	9.0
CMR SOLO BOOK	A0114.11	164	1	IN FDF (R12/IN R3)	.9	1072.0	26.0	9.0
RESCUE CHECK	A0114.15	164	1	IN FDF (R12/IN R3)	.9	1072.0	26.0	9.0
PANEL INT.-VERB/NOON LIST	H0104.	115	1	GNIC PANEL	.2	1050.0	.0	22.0
SLEEP RESTRAINT ASSY-LH	L3022.	117	1	AFT UPR EQUIP. BAY-LF	3.7	1018.0	-21.9	-49.9
SLEEP RESTRAINT ASSY-RH	C3023.	117	1	AFT UPR EQUIP. BAY-RH	3.7	1018.0	25.0	-47.9
CM EQUIP. RELOC. 1					510.50	1042.10	-7.34	-10.57

NOTE: Further information relating to this table is given on pages 3.4-19, 3.4-20 and 3.4-21.

Table 3.4-9.2 (Continued)

MISSION H-3 TRANSFERRED CREW AND EQUIPMENT STOWAGE LIST								
ITEMS REARRANGED IN CM PRIOR TO FIRST MID-COURSE CORRECTION (2)								
APILLI COORDINATES								
DESCRIPTION	STCW. ITEM	REF	NO.	STOWAGE LOCATION	WEIGHT	X-C.G.	Y-C.G.	Z-C.G.
CREW-COMMAND MODULE PILOT(CMP)	TBD	227	1	CR COUCH(LH CREW STA	161.0	1043.0	-24.5	-10.4
CREW-COMMANDER (CDR)	TBD	227	1	CR COUCH(CTR CREW STA	171.0	1043.0	.0	-10.4
TURNSU+LIME SUIT ASSY, IV-CMP.	B0201.1	127	1	IN CM PGA CONTAINER	30.3	1011.0	.0	-14.0
HELMET ASSY, PRESSURE-CMP.	B0201.2	127	1	IN CMP HSB-LH BHC	2.5	1043.0	-22.0	-55.0
GLOVES, IV(PAIR)-CMP.	B0201.3	127	1	IN ACCES.BAG(HSB/CMP	1.7	1043.0	-22.0	-55.5
COMMUNICATIONS CARRIER-CMP.	B0201.4	127	1	IN ACCES.BAG(HSB/CMP	1.6	1043.0	-22.0	-55.5
PCKET, CHECKLIST+SCISSORS-CMP.	B0201.5	167	1	IN ICG-CMP./LH STA.	.2	1043.0	-24.5	-10.4
PCKET, CHECKLIST-CMP	B0201.6	167	1	IN ICG-CMP./LH STA.	.2	1043.0	-24.5	-10.4
VEST, DUAL LIFE-CMP.	B0202.	111	1	IN ACCES.BAG(HSB/CMP	2.4	1043.0	-22.0	-55.5
BAG, ACTION SICKNESS-CMP.	A0200.	111	1	IN PGA (PGA CNT)	.1	1011.0	.0	-14.0
JULIA-CMP.	F0205.	117	1	IN PGA (PGA CNT)	.5	1011.0	.0	-14.0
T-ADAPTER, CWG-CMP.	F0135.	111	1	CR CPW-CMP(LH STA)	.4	1043.0	-24.5	-10.4
JACKET ASSY, ICG-CMP.	P0112.1	111	1	CR CREW-CMP(LH STA)	1.8	1043.0	-24.5	-10.4
TROUSER ASSY, ICG-CMP.	P0112.2	111	1	CR CREW-CMP(LH STA)	1.8	1043.0	-24.5	-10.4
HUUT, RIGHT, ICG-CMP.	P0112.3	111	1	CR CREW-CMP(LH STA)	.4	1043.0	-24.5	-10.4
HUUT, LEFT, ICG-CMP.	P0112.4	111	1	CR CREW-CMP(LH STA)	.4	1043.0	-24.5	-10.4
EARTUBE, UNIVERSAL-CMP.	F0105.1	111	1	CR ICG-CMP./LH STA.	NEGL	1043.0	-24.5	-10.4
HEADSET, LIGHTWEIGHT-CMP.	C0201.	111	1	CR CREW-CMP(LH STA)	1.1	1043.0	-24.5	-10.4
TURNSU+LIME SUIT ASSY, EV-CDR.	B0200.1	127	1	IN CM PGA CONTAINER	30.6	1011.0	.0	-14.0
HELMET ASSY, PRESSURE-CDR.	B0200.2	127	1	IN CDR HSB-LH LER	2.5	1048.0	-30.0	34.0
GLOVES, IV(PAIR)-CDR.	B0200.3	127	1	IN ACCES.BAG(HSB/CDR	1.6	1048.0	-30.0	34.0
COMMUNICATION CARRIER-CDR.	B0200.4	127	1	IN ACCES.BAG(HSB/CDR	1.6	1048.0	-30.0	34.0
PCKET, CHECKLIST+SCISSORS-CDR.	B0200.5	167	1	IN ICG-CDR./CTR.STA.	.2	1043.0	.0	-10.4
PCKET, CHECKLIST-CDR.	B0200.6	167	1	IN ICG-CDR./CTR.STA.	.2	1043.0	.0	-10.4
BAG, ACTION SICKNESS-CDR.	A0200.	111	1	IN PGA (PGA CNT)	.1	1011.0	.0	-14.0
JULIA-CDR.	B0205.	117	1	IN CM PGA CONTAINER	.5	1011.0	.0	-14.0
T-ADAPTER, CWG-CDR.	F0135.	111	1	CR CREW-CDR(CTR.STA)	.4	1043.0	.0	-10.4
JACKET ASSY, ICG-CDR.	P0112.1	111	1	CR CREW-CDR(CTR.STA)	1.8	1043.0	.0	-10.4
TROUSER ASSY, ICG-CDR.	P0112.2	111	1	CR CREW-CDR(CTR.STA)	1.8	1043.0	.0	-10.4
HUUT, RIGHT, ICG-CDR.	P0112.3	111	1	CR CREW-CDR(CTR.STA)	.4	1043.0	.0	-10.4
HUUT, LEFT, ICG-CDR.	P0112.4	111	1	CR CREW-CDR(CTR.STA)	.4	1043.0	.0	-10.4

NOTE: Further information relating to this table is given on pages 3.4-19, 3.4-20 and 3.4-21.

Table 3.4-9.2 (Continued)

MISSION H-3 TRANSFERRED CREW AND EQUIPMENT STOWAGE LIST								
ITEMS REARRANGED IN CM PRIOR TO FIRST MID-COURSE CORRECTION (2)								
APULLI COORDINATES								
DESCRIPTION	STOW. ITEM	REF	NO.	STOWAGE LOCATION	WEIGHT	X-C.G.	Y-C.G.	Z-C.G.
EAK TUBE, UNIVERSAL-CDR.	E0105.	111	1	LN ICG-CDR./CTR. STA.	NEGL	1043.0	.0	-10.4
BIG INSTRUMENTATION-CDR.	E0201.	111	1	LN CREW-CDR(CTR. STA)	1.1	1043.0	.0	-10.4
HEADSET, LIGHTWEIGHT-CDR.	E0104.	111	1	LN CREW-CDR(CTR. STA)	.4	1043.0	.0	-10.4
EAK PIECE, MLD DEDICOM. CARRI)-CDR.	E0200.1	111	1	LN ACCES. BAG(HSB/CDR	NEGL	1048.0	-30.0	34.0
EAK TUBE(COM. CARRIER)-CDR.	E0200.2	111	1	LN ACCES. BAG(HSB/CDR	NEGL	1048.0	-30.0	34.0
TUR SUIT LMP. SUIT ASSY, EV-LMP.	B0200.1	127	1	LN CM PGA CONTAINER	38.6	1011.0	.0	-14.0
HELMET ASSY, PRESSURE-LMP.	B0200.2	127	1	LN LMP HSB-RH BHD	2.5	1034.0	22.0	-55.0
GLOVES, IV(PAIR)-LMP.	B0200.7	127	1	LN ACCES. BAG(HSB/LMP	1.8	1034.0	22.0	-55.0
COMMUNICATIONS CARRIER-LMP.	B0200.4	127	1	LN ACCES. BAG(HSB/LMP	1.6	1034.0	22.0	-55.0
POCKET, CHECKLIST+SCISSORS-LMP.	B0200.5	167	1	LN ICG-LMP./RH STA.	.2	1043.0	24.5	-10.4
POCKET, CHECKLIST-LMP.	B0200.6	167	1	LN ICG-LMP./RH STA.	.2	1043.0	24.5	-10.4
VEST, DUAL LIFE-LMP.	R0202.	111	1	LN ACCES. BAG(HSB/LMP	2.4	1034.0	22.0	-55.0
BAG, UTILN SICKNESS-LMP.	A0208.	111	1	LN CM PGA (PGA CONT)	.1	1011.0	.0	-14.0
ULTA-LMP.	H0205.	117	1	LN CM PGA CONTAINER	.5	1011.0	.0	-14.0
T-CAPTEK, CWU-LMP.	H0135.	111	1	LN CREW-LMP(RH STA)	.4	1043.0	24.5	-10.4
JACKET ASSY, ICG-LMP.	R0112.1	111	1	LN CREW-LMP(RH STA)	1.8	1043.0	24.5	-10.4
TRUCKER ASSY, ICG-LMP.	F0112.2	111	1	LN CREW-LMP(RH STA)	1.8	1043.0	24.5	-10.4
BOOT, RIGHT, ICG-LMP.	F0112.3	111	1	LN CREW-LMP(RH STA)	.4	1043.0	24.5	-10.4
BOOT, LEFT, ICG-LMP.	F0112.4	111	1	LN CREW-LMP(RH STA)	.4	1043.0	24.5	-10.4
EAK TUBE, UNIVERSAL-LMP.	F0105.	111	1	LN ICG-LMP./RH STA.	NEGL	1043.0	24.5	-10.4
HEADSET, LIGHTWEIGHT-LMP.	F0104.	111	1	LN CREW-LMP(RH STA)	.4	1043.0	24.5	-10.4
EAK PIECE, MLD DEDICOM. CARRI).LMP.	E0200.1	111	1	LN ACCES. BAG(HSB/LMP	NEGL	1034.0	22.0	-55.0
EAK TUBE(COM. CARRIER)-LMP.	E0200.2	111	1	LN ACCES. BAG(HSB/LMP	NEGL	1034.0	22.0	-55.0
BAG, HELMET STOW, INFLIGHT-LMP.	H0105.	115	1	LN RH BHD-HSB/CMF	.6	1043.0	-22.0	-55.0
BAG, HELMET STOW, INFLIGHT-CDR.	B0105.	115	1	LN LEB-HSB/CDR	.6	1048.0	-30.0	34.0
BAG, HELMET STOW, INFLIGHT-LMP.	R0105.	115	1	LN RH BHD-HSB/LMP	.6	1034.0	22.0	-55.0
BAG, ACCESSORY-CMP.	R0105.1	115	1	LN CMF HSB-LH BHD	.3	1043.0	-22.0	-55.0
BAG, ACCESSORY-CDR.	R0105.1	115	1	LN CDR HSB-LH LFB	.3	1048.0	-30.0	34.0
BAG, ACCESSORY-LMP.	R0105.1	115	1	LN LMP HSB-RH BHD	.3	1034.0	22.0	-55.0
CONTAINER, TEMP. STOW-CMP.	C0301.	115	1	LN LEB-TSB	1.7	1039.5	33.5	34.0
CONTAINER, TEMP. STOW-CDR.	C0301.	115	1	LN GIRTH PING/TSE	1.7	1028.0	-45.0	-28.0
CONTAINER, TEMP. STOW-LMP.	C0301.	115	1	LN RH GIRTH RING-TSP	1.7	1030.0	36.0	-43.0

NOTE: Further information relating to this table is given on pages 3.4-19, 3.4-20 and 3.4-21.

Table 3.4-9.2 (Continued)

MISSION M-3 TRANSFERRED CREW AND EQUIPMENT STORAGE LIST								
ITEMS REARRANGED IN CM PRIOR TO FIRST MID-COURSE CORRECTION (2)								
APOLLO COORDINATES								
DESCRIPTION	STCW ITEM	REF	NO.	STOWAGE LOCATION	WEIGHT	X-C.G.	Y-C.G.	Z-C.G.
CONTAINER #12	C0344	115	1	CCNT.R12(RH GRTH BAG)	2.7	1034.0	41.0	-21.0
CSM LAUNCH CHECKLIST	A0114.1	164	2	FDF(R12/RH GRTH.RAG)	1.0	1034.0	41.0	-21.0
CSM W/C CHECKLIST	A0114.2	164	1	FDF(R12/RH GRTH.RAG)	1.0	1034.0	41.0	-21.0
CSM SYSTEM CHECKLIST	A0114.3	164	1	FDF(R12/RH GRTH.RAG)	1.0	1034.0	41.0	-21.0
CSM LUNAR LANDMARK MAP	A0114.5	164	1	FDF(R12/RH GRTH.RAG)	.6	1034.0	41.0	-21.0
CSM DATA SYSTEMS	A0114.7	164	1	FDF(R12/RH GRTH.RAG)	.9	1034.0	41.0	-21.0
CSM MALFUNCTIONS PROCEDURES	A0114.8	164	1	FDF(R12/RH GRTH.RAG)	.6	1034.0	41.0	-21.0
FLIGHT PLAN	A0114.9	164	1	FDF(R12/RH GRTH.RAG)	3.0	1034.0	41.0	-21.0
CMC SULE BOOK	A0114.11	164	1	FDF(R12/RH GRTH.RAG)	.9	1034.0	41.0	-21.0
RESCUE PLAN	A0114.15	164	1	FDF(R12/RH GRTH.RAG)	.9	1034.0	41.0	-21.0
PANEL IND.-VERB/ADUM LIST	H0104.	115	1	DATA CARD KIT (R3)	.2	1072.0	26.0	9.0
SLEEP RESTRAINT ASSY-LH	03022.	117	1	UNDER LH COUCH	3.7	1018.0	-24.5	-15.0
SLEEP RESTRAINT ASSY-RH	C3023.	117	1	UNDER RH COUCH	3.7	1018.0	24.5	-15.0
CM EQUIP.RELOC.1					510.50	1035.37	-7.06	-12.54

NOTE: Further information relating to this table is given on pages 3.4-19, 3.4-20 and 3.4-21.

Table 3.4-9.2 (Continued)

MISSION H-3 TRANSFERRED CREW AND EQUIPMENT STOWAGE LIST								
ITEMS REARRANGED IN CM PRIOR TO LM ACTIVATION (3)								
APOLLO COORDINATES								
DESCRIPTION	STOW. ITEM	REF	NO.	STOWAGE LOCATION	WFIGHT	X-C.G.	Y-C.G.	Z-C.G.
TURSU+LIMP SUIT ASSY, IV-CMP.	PO201.1	127	1	IN CM PGA CONTAINER	20.3	1011.0	.0	-14.0
HELMET ASSY, PRESSURE-CMP.	PO201.2	127	1	IN CMP HSR-LH BHC	2.5	1043.0	-22.0	-55.0
GLOVES, IV(PAIR)-CMP.	PO201.3	127	1	IN ACCES.BAG(HSB/CMP)	1.7	1043.0	-22.0	-55.5
COMMUNICATIONS CARRIER-CMP.	PO201.4	127	1	IN ACCES.BAG(HSB/CMP)	1.4	1043.0	-22.0	-55.5
PULKET, CHECKLIST+SCISSORS-CMP.	PO201.5	167	1	CN ICG-CMP./LH STA.	.2	1043.0	-24.5	-10.4
PULKET, CHECKLIST-CMP	PO201.6	167	1	CN ICG-CMP./LH STA.	.2	1043.0	-24.5	-10.4
BAG, MOTION SICKNESS-CMP.	AO209.	111	1	CN PGA (PGA CONT)	.1	1011.0	.0	-14.0
ULTA-CMP.	PO205.	117	1	CN PGA (PGA CONT)	.5	1011.0	.0	-14.0
T-ADAPTER, CNG-CMP.	FO135.	111	1	CN CREW-CMP(LH STA)	.4	1043.0	-24.5	-10.4
PULKET ASSY, ICG-CMP.	FO112.1	111	1	CN CREW-CMP(LH STA)	1.8	1043.0	-24.5	-10.4
THROUSE ASSY, ICG-CMP.	FO112.2	111	1	CN CREW-CMP(LH STA)	1.8	1043.0	-24.5	-10.4
SHOULDER, RIGHT, ICG-CMP.	FO112.3	111	1	CN CREW-CMP(LH STA)	.4	1043.0	-24.5	-10.4
SHOULDER, LEFT, ICG-CMP.	FO112.4	111	1	CN CREW-CMP(LH STA)	.4	1043.0	-24.5	-10.4
EARTUBE, UNIVERSAL-CMP.	EO105.1	111	1	CN ICG-CMP./LH STA.	NEGL	1043.0	-24.5	-10.4
HEADSET, LIGHTWEIGHT-CMP.	EO104.	111	1	CN CREW-CMP(LH STA)	.4	1043.0	-24.5	-10.4
SUBSYSTEM, FECAL CONTAINMENT-CMP	EO113.	117	1	AREA UI	.7	1033.0	23.0	-50.0
TURSU+LIMP SUIT ASSY, EV-CDR.	PO200.1	127	1	IN CM PGA CONTAINER	38.6	1011.0	.0	-14.0
HELMET ASSY, PRESSURE-CDR.	PO200.2	127	1	IN CDR HSR-LH LER	2.5	1048.0	-30.0	34.0
GLOVES, IV(PAIR)-CDR.	PO200.3	127	1	IN ACCES.BAG(HSB/CDR)	1.6	1048.0	-30.0	34.0
COMMUNICATION CARRIER-CDR.	PO200.4	127	1	IN ACCES.BAG(HSB/CDR)	1.6	1048.0	-30.0	34.0
PULKET, CHECKLIST+SCISSORS-CDR.	PO200.5	167	1	CN ICG-CDR./CTR.STA.	.2	1043.0	.0	-10.4
PULKET, CHECKLIST-CDR.	PO200.6	167	1	CN ICG-CDR./CTR.STA.	.2	1043.0	.0	-10.4
ULTA-CDR.	PO205.	117	1	IN CM PGA CONTAINER	.5	1011.0	.0	-14.0
T-ADAPTER, CNG-CDR.	FO135.	111	1	CN CREW-CDR(CTR.STA)	.4	1043.0	.0	-10.4
PULKET ASSY, ICG-CDR.	FO112.1	111	1	CN CREW-CDR(CTR.STA)	1.8	1043.0	.0	-10.4
THROUSE ASSY, ICG-CDR.	FO112.2	111	1	CN CREW-CDR(CTR.STA)	1.8	1043.0	.0	-10.4
SHOULDER, RIGHT, ICG-CDR.	FO112.3	111	1	CN CREW-CDR(CTR.STA)	.4	1043.0	.0	-10.4
SHOULDER, LEFT, ICG-CDR.	FO112.4	111	1	CN CREW-CDR(CTR.STA)	.4	1043.0	.0	-10.4
EARTUBE, UNIVERSAL-CDR.	EO105.	111	1	CN ICG-CDR./CTR.STA.	NEGL	1043.0	.0	-10.4
HEADSET, LIGHTWEIGHT-CDR.	EO104.	111	1	CN CREW-CDR(CTR.STA)	.4	1043.0	.0	-10.4
GARMENT, CONSTANT WEAR-CDR.	PO204.	111	1	CN CREW-CDR(CTR.STA)	.8	1043.0	.0	-10.4
GARMENT, LIQUID COOLING - CDR.	HO107.	111	1	AREA UI	5.0	1033.0	23.0	-50.0

NOTE: Further information relating to this table is given on pages 3.4-19, 3.4-20 and 3.4-21.

Table 3.4-9.2 (Continued)

MISSION H-3 TRANSFERRED CREW AND EQUIPMENT STOWAGE LIST								
ITEMS REARRANGED IN CM PRIOR TO LM ACTIVATION (3)								
						APOLLO COORDINATES		
DESCRIPTION	STOW. ITEM	REF	NG.	STOWAGE LOCATION	WEIGHT	X-C.G.	Y-C.G.	Z-C.G.
EARPIECE, MOLDED (CM. CARR.)-CDR.	E0200.1	111	1	IN ACCES. BAG (HSB/CDR	NEGL	1048.0	-30.0	34.0
EAR TUBE (CM. CARRIER)-CDR.	E0200.2	111	1	IN ACCES. BAG (HSB/CDR	NEGL	1048.0	-30.0	34.0
TORSO+LIMB SUIT ASSY, EV-LMP.	B0200.1	127	1	IN CM PGA CONTAINER	38.6	1011.0	.0	-14.0
HELMET ASSY, PRESSURE-LMP.	B0200.2	127	1	IN LMP HSB-RH BHC	2.5	1034.0	22.0	-55.0
GLOVES, IVIPAIR)-LMP.	B0200.7	127	1	IN ACCES. BAG (HSB/LMP	1.8	1034.0	22.0	-55.0
COMMUNICATIONS CARRIER-LMP.	B0200.4	127	1	IN ACCES. BAG (HSB/LMP	1.6	1034.0	22.0	-55.0
PULKET, CHECKLIST+SCISSORS-LMP.	B0200.5	167	1	ON ICG-LMP./RH STA.	.2	1043.0	24.5	-10.4
PULKET, CHECKLIST-LMP.	B0200.6	167	1	ON ICG-LMP./RH STA.	.2	1043.0	24.5	-10.4
HLTA-LMP.	B0205.	117	1	IN CM PGA CONTAINER	.5	1011.0	.0	-14.0
T-ADAPTER, CWG-LMP.	P0135.	111	1	ON CREW-LMP (RH STA)	.4	1043.0	24.5	-10.4
JACKET ASSY, ICG-LMP.	P0112.1	111	1	ON CREW-LMP (RH STA)	1.8	1043.0	24.5	-10.4
TROUSER ASSY, ICG-LMP.	P0112.2	111	1	ON CREW-LMP (RH STA)	1.8	1043.0	24.5	-10.4
SOOT, RIGHT, ICG-LMP.	P0112.3	111	1	ON CREW-LMP (RH STA)	.4	1043.0	24.5	-10.4
SOOT, LEFT, ICG-LMP.	P0112.4	111	1	ON CREW-LMP (RH STA)	.4	1043.0	24.5	-10.4
EAR TUBE, UNIVERSAL-LMP.	E0105.	111	1	ON ICG-LMP./RH STA.	NEGL	1043.0	24.5	-10.4
HEADSET, LIGHTWEIGHT-LMP.	E0104.	111	1	ON CREW-LMP (RH STA)	.4	1043.0	24.5	-10.4
CLOTHING, CONSTANT WEAR-LMP.	B0208.	111	1	ON CREW-LMP (RH STA)	.8	1043.0	24.5	-10.4
CLOTHING, LIQUID COOLING - LMP.	B0107.	111	1	AREA UI	5.0	1033.0	23.0	-50.0
EARPIECE, MOLDED (CM. CARR.) LMP.	E0200.1	111	1	IN ACCES. BAG (HSB/LMP	NEGL	1034.0	22.0	-55.0
EAR TUBE (CM. CARRIER)-LMP.	E0200.2	111	1	IN ACCES. BAG (HSB/LMP	NEGL	1034.0	22.0	-55.0
SUBSYSTEM, FECAL CONTAINMENT-CDR	R0113.	117	1	AREA UI	.3	1033.0	23.0	-50.0
SUBSYSTEM, FECAL CONTAINMENT-LMP	R0113.	117	1	AREA UI	.3	1033.0	23.0	-50.0
WATER SYS ASSY, RETURN CONT.	C6444.	111	1	IN CM PGA CONTAINER	9.0	1011.0	.0	-14.0
C4 EQUIP. RELIC. 2					164.80	1019.26	.62	-17.24

NOTE: Further information relating to this table is given on pages 3.4-19, 3.4-20 and 3.4-21.

Table 3.4-9.2 (Continued)

MISSION M-3 TRANSFERRED CREW AND EQUIPMENT STOWAGE LIST								
ITEMS REARRANGED IN CM PRIOR TO LM ACTIVATION (4)								
APOLLO COORDINATES								
DESCRIPTION	STGW. ITEM	REF	NO.	STOWAGE LOCATION	WEIGHT	X-C.G.	Y-C.G.	Z-C.G.
TURSO+LMP SUIT ASSY, IV-CMP.	P0201.1	127	1	IN CREW-CMP(LH STA)	30.3	1043.0	-24.5	-10.4
HELMET ASSY, PRESSURE-CMP.	B0201.2	127	1	IN CREW-CMP(LH STA)	2.5	1043.0	-24.5	-10.4
GLOVES, IV(PAIR)-CMP.	B0201.3	127	1	IN CREW-CMP(LH STA)	1.7	1043.0	-24.5	-10.4
COMMUNICATIONS CARRIER-CMP.	B0201.4	127	1	IN CREW-CMP(LH STA)	1.6	1043.0	-24.5	-10.4
PULKET, CHECKLIST+SCISSORS-CMP.	B0201.5	167	1	IN PGA (CREW-LH STA)	.2	1043.0	-24.5	-10.4
PULKET, CHECKLIST-CMP	P0201.6	167	1	IN PGA (CREW-LH STA)	.2	1043.0	-24.5	-10.4
HAT, HETTER STIFFNESS-CMP.	A0208.	111	1	IN PGA (CREW-LH STA)	.1	1043.0	-24.5	-10.4
JUTA-CMP.	P0205.	117	1	IN CREW-CMP(LH STA)	.5	1043.0	-24.5	-10.4
T-ADAPTER, LMI-CMP.	B0135.	111	1	IN ADAPTER BAG (AH)	.4	1012.0	22.0	-23.0
JACKET ASSY, ICG-CMP.	B0112.1	111	1	IN CM PGA CONTAINER	1.8	1011.0	.0	-14.0
TROUSER ASSY, ICG-CMP.	B0112.2	111	1	IN CM PGA CONTAINER	1.8	1011.0	.0	-14.0
HAT, RIGHT, ICG-CMP.	B0112.3	111	1	IN CM PGA CONTAINER	.4	1011.0	.0	-14.0
HAT, LEFT, ICG-CMP.	B0112.4	111	1	IN CM PGA CONTAINER	.4	1011.0	.0	-14.0
EARTH, UNIVERSAL-CMP.	F0105.1	111	1	IN ICG (PGA CONTAIN)	NEGL	1011.0	.0	-14.0
HEADSET, LIGHTWEIGHT-CMP.	F0104.	111	1	AREA AB	.4	1012.0	22.0	-23.0
SUBSYSTEM, FICAL CONTAINMENT-CMP	B0113.	117	1	IN CREW-CMP(LH STA)	.3	1043.0	-24.5	-10.4
TURSO+LMP SUIT ASSY, IV-CDR.	B0200.1	127	1	IN CREW-CDR(CTR. STA)	38.6	1043.0	.0	-10.4
HELMET ASSY, PRESSURE-CDR.	B0200.2	127	1	IN CREW-CDR(CTR. STA)	2.5	1043.0	.0	-10.4
GLOVES, IV(PAIR)-CDR.	B0200.3	127	1	IN CREW-CDR(CTR. STA)	1.6	1043.0	.0	-10.4
COMMUNICATION CARRIER-CDR.	B0200.4	127	1	IN CREW-CDR(CTR. STA)	1.6	1043.0	.0	-10.4
PULKET, CHECKLIST+SCISSORS-CDR.	B0200.5	167	1	IN PGA(CREW-CTR STA)	.2	1043.0	.0	-10.4
PULKET, CHECKLIST-CDR.	B0200.6	167	1	IN PGA(CREW-CTR STA)	.2	1043.0	.0	-10.4
JUTA-CDR.	P0205.	117	1	IN CREW-CDR(CTR. STA)	.5	1043.0	.0	-10.4
T-ADAPTER, LMI-CDR.	B0135.	111	1	IN ADAPTER BAG (AP)	.4	1012.0	22.0	-23.0
JACKET ASSY, ICG-CDR.	B0112.1	111	1	IN CM PGA CONTAINER	1.8	1011.0	.0	-14.0
TROUSER ASSY, ICG-CDR.	B0112.2	111	1	IN CM PGA CONTAINER	1.8	1011.0	.0	-14.0
HAT, RIGHT, ICG-CDR.	B0112.3	111	1	IN CM PGA CONTAINER	.4	1011.0	.0	-14.0
HAT, LEFT, ICG-CDR.	B0112.4	111	1	IN CM PGA CONTAINER	.4	1011.0	.0	-14.0
EARTH, UNIVERSAL-CDR.	F0105.	111	1	IN ICG (PGA CONTAIN)	NEGL	1011.0	.0	-14.0
HEADSET, LIGHTWEIGHT-CDR.	F0104.	111	1	AREA AB	.4	1012.0	22.0	-23.0
GARMENT, ELASTIC WEAR-CDR.	P0208.	111	1	IN CM PGA CONTAINER	.8	1011.0	.0	-14.0
GARMENT, LIQUID COOLING - CD.	P0107.	111	1	IN CREW-CDR(CTR. STA)	5.0	1043.0	.0	-10.4

NOTE: Further information relating to this table is given on pages 3.4-19, 3.4-20 and 3.4-21.

Table 3.4-9.2 (Continued)

MISSION H-3 TRANSFERRED CREW AND EQUIPMENT STOWAGE LIST								
ITEMS REARRANGED IN CM PRIOR TO LM ACTIVATION (4)								
APOLLO COORDINATES								
DESCRIPTION	STCW. ITEM	REF	NO.	STOWAGE LOCATION	WEIGHT	X-C.G.	Y-C.G.	Z-C.G.
EMK PIECE, POLYMEDICCM, CARK)-CDR.	E0200.1	111	1	CM CREW-CDR(CTR. STA)	NEGL	1043.0	.0	-10.4
EAK TUBE(CCM, CARRIER)-CDR.	E0200.2	111	1	CM CREW-CDR(CTR. STA)	NEGL	1043.0	.0	-10.4
TUNSOULMP SUIT ASSY, EV-LMP.	E0200.1	127	1	CM CREW-LMP(RH STA)	38.6	1043.0	24.5	-10.4
HELMET ASSY, PRESSURE-LMP.	E0200.2	127	1	CM CREW-LMP(RH STA)	2.5	1043.0	24.5	-10.4
GLOVES, IV(PAIR)-LMP.	E0200.7	127	1	CM CREW-LMP(RH STA)	1.8	1043.0	24.5	-10.4
COMMUNICATIONS CARRIER-LMP.	E0200.4	127	1	CM CREW-LMP(RH STA)	1.6	1043.0	24.5	-10.4
PULKET, CHECKLIST+SCISSORS-LMP.	E0200.5	167	1	CM PGA (CREW-PH STA)	.2	1043.0	24.5	-10.4
PULKET, CHECKLIST-LMP.	E0200.6	167	1	CM PGA (CREW-PH STA)	.2	1043.0	24.5	-10.4
JLTA-LMP.	B0205.	117	1	CM CREW-LMP(PH STA)	.5	1043.0	24.5	-10.4
T-ADAPTER, CWG-LMP.	P0135.	111	1	IN ADAPTER BAG (AP)	.4	1012.0	22.0	-23.0
PULKET ASSY, ICG-LMP.	B0112.1	111	1	IN CM PGA CONTAINER	1.8	1011.0	.0	-14.0
TRAY ASSY, ICG-LMP.	B0112.2	111	1	IN CM PGA CONTAINER	1.8	1011.0	.0	-14.0
SUB, RIGHT, ICG-LMP.	B0112.3	111	1	IN CM PGA CONTAINER	.4	1011.0	.0	-14.0
SUB, LEFT, ICG-LMP.	B0112.4	111	1	IN CM PGA CONTAINER	.4	1011.0	.0	-14.0
EAK TUBE, UNIVERSAL-LMP.	E0105.	111	1	UN ICG (PGA CONTAIN)	NEGL	1011.0	.0	-14.0
HEADSET, LIGHTWEIGHT-LMP.	E0104.	111	1	AREA AB	.4	1012.0	22.0	-23.0
GARMENT, CONSTANT WEAR-LMP.	B0208.	111	1	IN CM PGA CONTAINER	.8	1011.0	.0	-14.0
GARMENT, LIQUID COOLING - LMP.	H0107.	111	1	CM CREW-LMP(RH STA)	5.0	1043.0	24.5	-10.4
EMK PIECE, POLYMEDICCM, CARK, LMP.	E0200.1	111	1	CM CREW-LMP(RH STA)	NEGL	1043.0	24.5	-10.4
EAK TUBE(CCM, CARRIER)-LMP.	E0200.2	111	1	CM CREW-LMP(RH STA)	NEGL	1043.0	24.5	-10.4
SUBSYSTEM, FECAL CONTAINMENT-CDR	B0113.	117	1	CM CREW-CDR(CTR. STA)	.3	1043.0	.0	-10.4
SUBSYSTEM, FECAL CONTAINMENT-LMP	H0113.	117	1	CM CREW-LMP(RH STA)	.3	1043.0	24.5	-10.4
WATER SYS ASSY, RETURN CONT.	C6444.	111	1	AFT UEB CENTER (APRX)	9.0	1018.C	.0	.0
CM EQUIP. REFLOC?					164.80	1038.31	2.30	-10.34

NOTE: Further information relating to this table is given on pages 3.4-19, 3.4-20 and 3.4-21.

Table 3.4-9.2 (Continued)

MISSION H-3 TRANSFERRED CREW AND EQUIPMENT STOWAGE LIST								
ITEMS REARRANGED IN LM PRIOR TO LM ACTIVATION (S)								
DESCRIPTION	STCW. ITEM	REF	NO.	STOWAGE LOCATION	WEIGHT	LM COORDINATES		
						X-C.G.	Y-C.G.	Z-C.G.
MAGAZINE, 15MM DATA ACQUISITION	A0101.1	111	1	ISA(CTR.INST.PANEL)	1.0	268.0	.0	52.0
BAG,STOW,REF,15MM MAG.	C6393.	111	1	ISA(CTR.INST.PANEL)	.1	268.0	.0	52.0
BRACKET,WEDGL,15MM CAMERA	A1C41.	115	1	ISA(CTR.INST.PANEL)	1.3	268.0	.0	52.0
JILITY LIGHTS W/CORD + CLAMP	C3006.	115	1	ISA(CTR.INST.PANEL)	1.4	268.0	.0	52.0
JILITY LIGHTS W/CORD + CLAMP	C3006.	115	1	ISA(CTR.INST.PANEL)	1.4	268.0	.0	52.0
INTERIM STOW. ASSY (ISA)	C3007.	114	* 1	FRONT/CENTR.INST.PNL	7.6	268.0	.0	52.0
BRACKET,CAMERA MOUNT	F1001.1	115	1	IN BRKT.BG(ISA/PNL)	.6	268.0	.0	52.0
BRACKET,CAMERA MOUNT	F1001.1	115	1	IN BRKT.BG(ISA/PNL)	.6	268.0	.0	52.0
BRACKET,CAMERA MOUNT,BRACKET	C3034.	115	1	ISA(CTR.INST.PANEL)	.3	268.0	.0	52.0
DEVICE, IN-SUIT DRINKING	F1048.	114	2	ISA(CTR.INST.PANEL)	.2	268.0	.0	52.0
BAG,STOWAGE,THERMAL SAMPLES	F1060.	111	2	ISA(CTR.INST.PANEL)	.2	268.0	.0	52.0
SAMPLES,THERMAL COAT,DEGRADE	F1002.	111	2	ISA(CTR.INST.PANEL)	.8	268.0	.0	52.0
ELECTRICAL ASSY(ASA SHORT,PLG)	U3019.	111	1	ISA(CTR.INST.PANEL)	.1	268.0	.0	52.0
BAG,TEMPERARY STOWAGE	C3031.	111	1	ISA(CTR.INST.PANEL)	.9	268.0	.0	52.0
LM EQUIP.PELIC.1					16.50	268.00	.00	52.00

NOTE: Further information relating to this table is given on pages 3.4-19, 3.4-20 and 3.4-21.

Table 3.4-9.2 (Continued)

MISSION M-3 TRANSFERRED CREW AND EQUIPMENT STORAGE LIST								
ITEMS REARRANGED IN LM PRIOR TO LM ACTIVATION (6)								
DESCRIPTION	STCW. ITEM	PEF	NO.	STOWAGE LOCATION	WEIGHT	LM COORDINATES		
						X-C.G.	Y-C.G.	Z-C.G.
MAGAZINE, 16MM DATA ACQUISITION	A0101.1	111	1	ISA(OV.RECHAR.STAT)	1.0	270.3	-15.0	19.0
HAG, STOWAGE, 16MM MAG.	G6393.	111	1	ISA(OV.RECHAR.STAT)	.1	270.3	-15.0	19.0
BRACKET, WEDGE, 16MM CAMERA	A1041.	115	1	CN RH WINDOW BKPT	1.3	287.0	22.0	65.0
UTILITY LIGHTS w/CORD + CLAMP	G3006.	115	1	LH CREW STA/INSTALL.	1.4	251.4	-6.5	51.0
UTILITY LIGHTS w/CORD + CLAMP	G3006.	115	1	RH CREW STA/INSTALL.	1.4	251.4	6.5	52.0
INT EXTP STOW. ASSY (ISA)	L3007.	114	1	ISA(OV.RECHAR.STAT)	7.6	270.3	-15.0	19.0
BRACKET, CAMERA MOUNT	F1001.1	115	1	ISA(OV.RECHAR.STAT)	.6	270.3	-15.0	19.0
BRACKET, CAMERA MOUNT	F1001.1	115	1	ISA(OV.RECHAR.STAT)	.6	270.3	-15.0	19.0
HAG, CAMERA MOUNT BRACKET	G3034.	115	1	ISA(OV.RECHAR.STAT)	.3	270.3	-15.0	19.0
DEVICE, IN-SUIT DRINKING	F1048.	114	2	ISA(OV.RECHAR.STAT)	.2	270.3	-15.0	19.0
HAG, STOWAGE, THERMAL SAMPLES	F1060.	111	2	ISA(OV.RECHAR.STAT)	.2	270.3	-15.0	19.0
SAMPLES, THERMAL COAT. DEGRADE	F1002.	111	2	ISA(OV.RECHAR.STAT)	.8	270.3	-15.0	19.0
ELECTRICAL ASSY (ASA SHORT. PLG)	G3019.	111	1	ISA(OV.RECHAR.STAT)	.1	270.3	-15.0	19.0
HAG, TEMPORARY STOWAGE	G3031.	111	1	ISA(OV.RECHAR.STAT)	.9	270.3	-15.0	19.0
LM EQUIP. RELIC. 1					16.50	268.41	-9.54	28.14

NOTE: Further information relating to this table is given on pages 3.4-19, 3.4-20 and 3.4-21.

Table 3.4-9.2 (Continued)

MISSION H-3 TRANSFERRED CREW AND EQUIPMENT STOWAGE LIST								
ITEMS TRANSFERRED FROM CM INTO LM AT LM ACTIVATION (7)								
DESCRIPTION	STOW. ITEM	REF	NO.	STOWAGE LOCATION	WEIGHT	APOLLO COORDINATES		
						X-C.G.	Y-C.G.	Z-C.G.
CREW-COMMANDER (CDR)	TBC	227	1	CM COUCH(CTR CREW STA	171.0	1043.0	.0	-10.4
CREW-LM PILOT (LMP)	TBD	227	1	CM COUCH(RH CREW STA	185.0	1043.0	24.5	-10.4
THERMAL SUIT ASSY, EV-CDR.	R0200.1	127	1	LN CREW-CDR(CTR STA)	38.6	1043.0	.0	-10.4
HELMET ASSY, PRESSURE-CDR.	B0200.2	127	1	ON CREW-CDR(CTR STA)	2.5	1043.0	.0	-10.4
GLOVES, IV(PAIR)-CDR.	R0200.3	127	1	LN CREW-CDR(CTR STA)	1.6	1043.0	.0	-10.4
COMMUNICATION CARRIER-CDR.	R0200.4	127	1	UN CREW-CDR(CTR STA)	1.6	1043.0	.0	-10.4
PULKET, CHECKLIST+SCISSORS-CDR.	B0200.5	167	1	CM PGA(CREW-CTR STA)	.2	1043.0	.0	-10.4
PULKET, CHECKLIST-CDR.	R0200.6	167	1	CM PGA(CREW-CTR STA)	.2	1043.0	.0	-10.4
JLTA-CDR.	B0205.	117	1	LN CREW-CDR(CTR STA)	.5	1043.0	.0	-10.4
DIG INSTRUMENTATION-CDR.	CO201.	111	1	CM CREW-CDR(CTR STA)	1.1	1043.0	.0	-10.4
GARMENT, LIQUID COOLING - CDR.	BO107.	111	1	CM CREW-CDR(CTR STA)	5.0	1043.0	.0	-10.4
SAKPLUGS(PAIR)-CDR.	HO210.	111	1	CM PGA(CREW-CTR STA)	NEGL	1043.0	.0	-10.4
EAKPIECE, PCL DEC(CM, CARR)-CDR.	EO200.1	111	1	CM CREW-CDR(CTR STA)	NEGL	1043.0	.0	-10.4
EAKTUBE(CM, CARRIER)-CDR.	EO200.2	111	1	CM CREW-CDR(CTR STA)	NEGL	1043.0	.0	-10.4
SUNGLASSES-CDR.	A0200.	117	1	LN CREW-CDR(CTR STA)	.1	1043.0	.0	-10.4
POUCH, SUNGLASSES-CDR.	A0201.	117	1	LN CREW-CDR(CTR STA)	NEGL	1043.0	.0	-10.4
CHURUNGGRAPH-CDR.	A0202.	117	1	CM CREW-CDR(CTR STA)	.1	1043.0	.0	-10.4
WATCHBAND-CDR.	A0203.	117	1	ON CREW-CDR(CTR STA)	NEGL	1043.0	.0	-10.4
PENS, DATA RECORDING-CDR.	A0204.	117	1	CM CREW-CDR(CTR STA)	.1	1043.0	.0	-10.4
PEN, MARKER-CDR.	A0205.	117	1	LN CREW-CDR(CTR STA)	NEGL	1043.0	.0	-10.4
PENCIL-CDR.	A0206.	117	1	CM CREW-CDR(CTR STA)	.1	1043.0	.0	-10.4
PENLIGHTS-CDR.	B0206.	117	1	ON CREW-CDR(CTR STA)	.3	1043.0	.0	-10.4
BIBBELT ASSY-CDR.	B0207.	117	1	CM CREW-CDR(CTR STA)	.2	1043.0	.0	-10.4
JUSIMETER, PERSONAL-CDR.	DO200.	117	1	CM CREW-CDR(CTR STA)	.4	1043.0	.0	-10.4
JUSIMETER, PASSIVE-CDR.	DO201.	117	1	CMG POCKET(CREW-CDR)	NEGL	1043.0	.0	-10.4
THERMAL SUIT ASSY, EV-LMP.	R0200.1	127	1	CM CREW-LMP(RH STA)	38.6	1043.0	24.5	-10.4
HELMET ASSY, PRESSURE-LMP.	R0200.2	127	1	CM CREW-LMP(RH STA)	2.5	1043.0	24.5	-10.4
GLOVES, IV(PAIR)-LMP.	R0200.7	127	1	CM CREW-LMP(RH STA)	1.8	1043.0	24.5	-10.4
COMMUNICATIONS CARRIER-LMP.	R0200.4	127	1	CM CREW-LMP(RH STA)	1.6	1043.0	24.5	-10.4
PULKET, CHECKLIST+SCISSORS-LMP.	R0200.5	167	1	CM PGA (CREW-RH STA)	.2	1043.0	24.5	-10.4
PULKET, CHECKLIST-LMP.	R0200.6	167	1	CM PGA (CREW-RH STA)	.2	1043.0	24.5	-10.4

NOTE: Further information relating to this table is given on pages 3.4-19, 3.4-20 and 3.4-21.

Table 3.4-9.2 (Continued)

MISSION M-3 TRANSFERRED CREW AND EQUIPMENT STORAGE LIST								
ITEMS TRANSFERRED FROM CM INTO LM AT LM ACTIVATION (7)								
APOLLO COORDINATES								
DESCRIPTION	STOW. ITEM	REF	NO.	STOWAGE LOCATION	WEIGHT	X-C.G.	Y-C.G.	Z-C.G.
JCTA-LMP.	F0205.	117	1	GN CREW-LMP(RH STA)	.5	1043.0	24.5	-10.4
BIG INSTRUMENTATION-LMP.	C0201.	111	1	GN CREW-LMP(RH STA)	1.1	1043.0	24.5	-10.4
CLOTHING, LIQUID COOLING - LMP.	F0107.	111	1	GN CREW-LMP(RH STA)	5.0	1043.0	24.5	-10.4
PACK PLUGS (PAIR)-LMP.	F0210.	111	1	GN PGA (CREW-PH STA)	NEGL	1043.0	24.5	-10.4
PACK PIECE, MOLDED (COMM. CARR.) LMP.	F0200.1	111	1	GN CREW-LMP(PH STA)	NEGL	1043.0	24.5	-10.4
PACK TUBE (COMM. CARRIER)-LMP.	F0200.2	111	1	GN CREW-LMP(RH STA)	NEGL	1043.0	24.5	-10.4
SUNGLASSES-LMP.	A0200.	117	1	GN CREW-LMP(RH STA)	.1	1043.0	24.5	-10.4
POUCH, SUNGLASSES-LMP.	A0201.	117	1	GN CREW-LMP(RH STA)	NEGL	1043.0	24.5	-10.4
CHURUNGWAPH-LMP.	A0202.	117	1	GN CREW-LMP(RH STA)	.1	1043.0	24.5	-10.4
HAT CHDANC-LMP.	A0203.	117	1	GN CREW-LMP(RH STA)	NEGL	1043.0	24.5	-10.4
PENS, DATA RECORDING-LMP.	A0204.	117	1	GN CREW-LMP(RH STA)	.1	1043.0	24.5	-10.4
PEN S, MARKER-LMP.	A0205.	117	1	GN CREW-LMP(RH STA)	NEGL	1043.0	24.5	-10.4
PENCIL-LMP.	A0206.	117	1	GN CREW-LMP(RH STA)	.1	1043.0	24.5	-10.4
PENLIGHTS-LMP.	H0206.	117	1	GN CREW-LMP(RH STA)	.3	1043.0	24.5	-10.4
BIUBELT ASSY-LMP.	P0207.	117	1	GN CREW-LMP(RH STA)	.2	1043.0	24.5	-10.4
DUSTMETER, PERSONAL-LMP.	D0200.	117	1	GN CREW-LMP(RH STA)	.4	1043.0	24.5	-10.4
DUSTMETER, PASSIVE-LMP.	C0201.	117	1	CMG POCKET (CREW-LMP)	NEGL	1043.0	24.5	-10.4
LM ACTIVATION CHECKLIST	A0114.12	114	1	IN FDF (R3)	.5	1072.0	26.0	9.0
LM L.S. CHECKLIST	A0114.10	114	1	IN FDF (R3)	1.0	1072.0	26.0	9.0
LM SYSTEMS ACTIVATION CHECKLIST	A0114.12	114	1	IN FDF (R3)	.5	1072.0	26.0	9.0
LM TIMELINE BOOK	A0114.14	114	1	IN FDF (R3)	.5	1072.0	26.0	9.0
LM XFR DATA (AND) KIT	A0114.18	114	1	IN FDF (R3)	.6	1072.0	26.0	9.0
LM DATA CARD BOOK	A0114.19	114	1	IN FDF (R3)	.3	1072.0	26.0	9.0
LM ORBIT MONITOR CHART	A0114.22	114	1	IN FDF (R3)	.3	1072.0	26.0	9.0
DUSTMETER, PASSIVE RADIATION	D0101.	111	1	15MM MAG BAG (R13)	NEGL	1024.0	45.0	-26.0
SCISSORS	B0204.	111	1	GN CREW-CDR(CTR. STA)	.5	1043.0	.0	-10.4
BAG, STCW XFR, 16MM MAG.	C0380.	111	1	AREA R13	.3	1024.0	45.0	-26.0
BAG, 7J PH MAG(LM XFR)	C0381.	111	1	AREA R13	.5	1024.0	45.0	-26.0
MAGAZINE, 16MM DATA ACQUISITION	A0101.1	111	1	IN XFR BAG (R13)	1.0	1024.0	45.0	-26.0
MAGAZINE, 16MM DATA ACQUISITION	A0101.1	111	1	IN XFR BAG (R13)	1.0	1024.0	45.0	-26.0
MAGAZINE, 16MM DATA ACQUISITION	A0101.1	111	6	IN XFR BAG (R13)	6.0	1024.0	45.0	-26.0

NOTE: Further information relating to this table is given on pages 3.4-19, 3.4-20 and 3.4-21.

Table 3.4-9.2 (Continued)

MISSION H-3 TRANSFERRED CREW AND EQUIPMENT STORAGE LIST								
ITEMS TRANSFERRED FROM CM INTO LM AT LM ACTIVATION (7)								
DESCRIPTION	STOW. ITEM	REF	NO.	STOWAGE LOCATION	WEIGHT	APCLLC COORDINATES		
						X-C.G.	Y-C.G.	Z-C.G.
BAG, STOW+XFR, 16MM MAG.	C6393.	111	1	AREA R13	.1	1024.0	45.0	-26.0
MAGAZINE, 70 MM L.S. HASSEFL.	A010A.1	111	3	AREA R13	4.2	1024.0	45.0	-26.0
DISPENSER, TISSUE	B0103.	111	1	AREA A8	1.4	1012.0	22.0	-23.0
MAGAZINE, 70MM L.S. HASSELHLAD	A010B.1	111	2	IN XFR BAG (R13)	2.8	1024.0	45.0	-26.0
SUB SYSTEM, FECAL CONTAINMNT-CDW	B0113.	117	1	CN CREW-COR(CTR.STA)	.3	1043.0	.0	-10.4
SUB SYSTEM, FECAL CONTAINMNT-LMP	B0113.	117	1	CN CREW-LMP(RM STA)	.3	1043.0	24.5	-10.4
BAG, 70MM MAG. (LM XFR)	C6430.	111	1	AREA R13	.5	1024.0	45.0	-26.0
2 CREW+EQUIP, CM-LM					484.00	1042.49	13.84	-10.82

NOTE: Further information relating to this table is given on pages 3.4-19, 3.4-20 and 3.4-21.

Table 3.4-9.2 (Continued)

MISSION H-3 TRANSFERRED CREW AND EQUIPMENT STOWAGE LIST								
ITEMS TRANSFERRED FROM CM INTO LM AT LM ACTIVATION (R)								
LM COORDINATES								
DESCRIPTION	STCW ITEM	REF	NO.	STOWAGE LOCATION	WEIGHT	X-C.G.	Y-C.G.	Z-C.G.
CREW-COMMANDER (CDR)	T8D	227	1	LM CREW STATION-	171.0	260.0	-22.0	45.0
CREW-LM PILOT (LMP)	T8D	227	1	LM CREW STATION-	185.0	260.0	22.0	45.0
TURSU+LIME SUIT ASSY, EV-CDR.	P0200.1	127	1	CM CREW(LH CREW STA)	38.6	260.0	-22.0	45.0
HELMET ASSY, PRESSURE-CDR.	B0200.2	127	1	CM CREW(LH CREW STA)	2.5	260.0	-22.0	45.0
GLOVES, IV(PAIR)-CDR.	B0200.3	127	1	CM CREW(LH CREW STA)	1.6	260.0	-22.0	45.0
COMMUNICATION CARRIER-CDR.	B0200.4	127	1	CM CREW(LH CREW STA)	1.6	260.0	-22.0	45.0
PULCKET, CHECKLIST+SCISSORS-CDR.	B0200.5	167	1	CM PGA-CDR (ON CREW)	.2	250.6	-22.0	43.4
PULCKET, CHECKLIST-CDR.	B0200.6	167	1	CM PGA-CR (ON CREW)	.2	250.6	-22.0	43.4
JOTA-CDR.	P0205.	117	1	CM CREW(LH CREW STA)	.5	260.0	-22.0	45.0
BIOLUMINESCENCE-CDR.	C0201.	111	1	CM CREW(LH CREW STA)	1.1	260.0	-22.0	45.0
GARMENT, LIQUID COOLING - CDR.	R0107.	111	1	CM CREW(LH CREW STA)	5.0	260.0	-22.0	45.0
EAK PLUGS(PAIR)-CDR.	B0210.	111	1	CM PGA-CDR (ON CREW)	NEGL	250.6	-22.0	43.4
EAK PIECE, MOLDFORM. CARR)-CDR.	F0200.1	111	1	CM CREW(LH CREW STA)	NEGL	260.0	-22.0	45.0
EAK TUBE (CM. CARRIER)-CDR.	F0200.2	111	1	CM CREW(LH CREW STA)	NEGL	260.0	-22.0	45.0
SUNGLASSES-CDR.	A0200.	117	1	CM CREW(LH CREW STA)	.1	260.0	-22.0	45.0
POUCH, SUNGLASSES-CDR.	A0201.	117	1	CM CREW(LH CREW STA)	NEGL	260.0	-22.0	45.0
CHRONOGRAPH-CDR.	A0202.	117	1	CM CREW(LH CREW STA)	.1	260.0	-22.0	45.0
WATCHBAND-CDR.	A0203.	117	1	CM CREW(LH CREW STA)	NEGL	260.0	-22.0	45.0
PENS, DATA RECORDING-CDR.	A0204.	117	1	CM CREW(LH CREW STA)	.1	260.0	-22.0	45.0
PEN, MARKER-CDR.	A0205.	117	1	CM CREW(LH CREW STA)	NEGL	260.0	-22.0	45.0
PENCIL-CDR.	A0206.	117	1	CM CREW(LH CREW STA)	.1	260.0	-22.0	45.0
PENLIGHTS-CDR.	P0206.	117	1	CM CREW(LH CREW STA)	.3	260.0	-22.0	45.0
BELT ASSY-CDR.	R0207.	117	1	CM CREW(LH CREW STA)	.2	260.0	-22.0	45.0
JUSIMETER, PASSIVE-CDR.	D0200.	117	1	CM CREW(LH CREW STA)	.4	260.0	-22.0	45.0
JUSIMETER, PASSIVE-CDR.	D0201.	117	1	CM CREW(LH CREW STA)	NEGL	260.0	-22.0	45.0
TURSU+LIME SUIT ASSY, EV-LMP.	P0200.1	127	1	CM CREW(RH CREW STA)	38.6	260.0	22.0	45.0
HELMET ASSY, PRESSURE-LMP.	B0200.2	127	1	CM CREW(RH CREW STA)	2.5	260.0	22.0	45.0
GLOVES, IV(PAIR)-LMP.	B0200.7	127	1	CM CREW(RH CREW STA)	1.8	260.0	22.0	45.0
COMMUNICATIONS CARRIER-LMP.	B0200.4	127	1	CM CREW(RH CREW STA)	1.6	260.0	22.0	45.0
PULCKET, CHECKLIST+SCISSORS-LMP.	B0200.5	167	1	CM PGA-LMP (ON CREW)	.2	250.6	22.0	43.4
PULCKET, CHECKLIST-LMP.	F0200.6	167	1	CM PGA-LMP (ON CREW)	.2	250.6	22.0	43.4

NOTE: Further information relating to this table is given on pages 3.4-19, 3.4-20 and 3.4-21.

Table 3.4-9.2 (Continued)

MISSION H-3 TRANSFERRED CREW AND EQUIPMENT STOWAGE LIST								
ITEMS TRANSFERRED FROM CM INTO LM AT LM ACTIVATION (*)								
DESCRIPTION	STCW. ITEM	PFF	N _o .	STOWAGE LOCATION	WFIGHT	LM COORDINATES		
						X-C.G.	Y-C.G.	Z-C.G.
XLT A-LMP.	R0205.	117	1	CM CREW/PH CREW STA)	.5	260.0	22.0	45.0
BIG INSTRUMENTATION-LMP.	C0201.	111	1	CM CREW/PH CREW STA)	1.1	260.0	22.0	45.0
CAPMENT, LIQUID COOLING - LMP.	H0107.	111	1	CM CREW/PH CREW STA)	5.0	260.0	22.0	45.0
EAK PLUGS (PAIR)-LMP.	B0210.	111	1	CM PGA-LMP (ON CREW)	NEGL	250.6	22.0	43.4
EAK PIECE, MOLDED (COM. CARR.) LMP.	F0200.1	111	1	CM CREW/PH CREW STA)	NEGL	260.0	22.0	45.0
EAK TUBE (COM. CARRIER)-LMP.	EC200.2	111	1	CM CREW/PH CREW STA)	NEGL	260.0	22.0	45.0
SUNGLASSES-LMP.	A0200.	117	1	CM CREW/PH CREW STA)	.1	260.0	22.0	45.0
PUC CH, SUNGLASSES-LMP.	A0201.	117	1	CM CREW/PH CREW STA)	NEGL	260.0	22.0	45.0
CHRONOGRAPH-LMP.	A0202.	117	1	CM CREW/PH CREW STA)	.1	260.0	22.0	45.0
WATCH BAND-LMP.	A0203.	117	1	CM CREW/PH CREW STA)	NEGL	260.0	22.0	45.0
PENS, DATA RECORDING-LMP.	AC204.	117	1	CM CREW/PH CREW STA)	.1	260.0	22.0	45.0
PENS, MARKER-LMP.	A0205.	117	1	CM CREW/PH CREW STA)	NEGL	260.0	22.0	45.0
PENCIL-LMP.	A0206.	117	1	CM CREW/PH CREW STA)	.1	260.0	22.0	45.0
PENLIGHTS-LMP.	P0206.	117	1	CM CREW/PH CREW STA)	.3	260.0	22.0	45.0
SHOULDER ASSY-LMP.	P0207.	117	1	CM CREW/PH CREW STA)	.2	260.0	22.0	45.0
DOSIMETER, PERSONAL-LMP.	D0200.	117	1	CM CREW/PH CREW STA)	.4	260.0	22.0	45.0
DOSIMETER, PASSIVE-LMP.	D0201.	117	1	CM CREW/PH CREW STA)	NEGL	260.0	22.0	45.0
LM ACTIVATION CHECKLIST	A0114.12	114	1	LM XFR DATA CARD KIT	.5	280.8	-20.0	14.0
LM L.S. CHECKLIST	A0114.10	114	1	LM XFR DATA CARD KIT	1.0	280.8	-20.0	14.0
LM SYSTEMS ACTIVATION CHECKLIST	A0114.12	114	1	LM XFR DATA CARD KIT	.5	280.8	-20.0	14.0
LM TIMELINE BOOK	A0114.14	114	1	LM XFR DATA CARD KIT	.5	280.8	-20.0	14.0
LM XFR DATA CARD KIT	A0114.18	114	1	FLIGHT DATA FILE CTR	.6	280.8	-20.0	14.0
LM DATA CARD BOOK	A0114.19	114	1	LM XFR DATA CARD KIT	.3	280.8	-20.0	14.0
LM ORBIT MONITOR CHART	A0114.22	114	1	LM XFR DATA CARD KIT	.3	280.8	-20.0	14.0
DOSIMETER, PASSIVE RADIATION	P0101.	111	1	16MM MAG BAG (RHSSC)	NEGL	238.4	38.6	46.0
SLISSORS	R0204.	111	1	CM CREW/PH CREW STA)	.5	260.0	-22.0	45.0
BAG, STCW XFR, 16MM MAG.	U0380.	111	1	CM SIDE STOW. COMPT.	.3	238.4	38.6	43.0
BAG, 70 MM MAG (LM XFR)	U0381.	111	1	CM SIDE STOW. COMPT.	.5	238.4	38.6	43.0
MAGAZINE, 16MM DATA ACQUISITION	A0101.1	111	1	CM CAM/PH WINDOW PKT	1.0	287.0	22.0	65.0
MAGAZINE, 16MM DATA ACQUISITION	A0101.1	111	1	ISA (CTR. INST. PANEL)	1.0	268.0	.0	52.0
MAGAZINE, 16MM DATA ACQUISITION	A0101.1	111	6	XFR BAG (RHSSC)	6.0	238.4	38.6	46.0

NOTE: Further information relating to this table is given on pages 3.4-19, 3.4-20 and 3.4-21.

Table 3.4-9.2 (Continued)

MISSION H-3 TRANSFERRED CREW AND EQUIPMENT STOWAGE LIST								
ITEMS TRANSFERRED FROM CM INTO LM AT LM ACTIVATION (R)								
DESCRIPTION	STOW. ITEM	REF	NO.	STOWAGE LOCATION	WEIGHT	LM COORDINATES		
						X-C.G.	Y-C.G.	Z-C.G.
MAG, STOW XFF, 16MM MAG.	06393.	111	1	ISA(CTR. INST. PANEL)	.1	268.0	.0	52.0
MAGAZINE, 70 MM L.S. HASSEL.	A0108.1	111	3	RP SIDE STOW.COMPT.	4.2	238.4	38.6	43.0
DISPENSER, TISSUE	P0103.	111	1	RP SIDE STOW.COMPT.	1.4	238.4	38.6	43.0
MAGAZINE, 70MM L.S. HASSELBLAL	A0108.1	111	2	RP SIDE STOW.COMPT.	2.8	238.4	38.6	43.0
SUB SYSTEM, FECAL CONTAINMNT-CDR	H0113.	117	1	LN CREW(LH CREW STA)	.3	260.0	-22.0	45.0
SUB SYSTEM, FECAL CONTAINMNT-LMP	H0113.	117	1	LN CREW(RH CREW STA)	.3	260.0	22.0	45.0
MAG, 70MM MAG. (LM XFF)	06430.	111	1	RP SIDE STOW.COMPT.	.5	238.4	38.6	43.0
2 CREW+EQUIP, CM-LM					484.00	259.52	1.77	44.79

NOTE: Further information relating to this table is given on pages 3.4-19, 3.4-20 and 3.4-21.

Table 3.4-9.2 (Continued)

MISSION M-3 TRANSFERRED CREW AND EQUIPMENT STOWAGE LIST								
ITEMS TRANSFERRED FROM LM INTO CM AT LM ACTIVATION (9)								
DESCRIPTION	STOW. ITEM	REF	NO.	STOWAGE LOCATION	WEIGHT	LM COORDINATES		
						X-C.G.	Y-C.G.	Z-C.G.
CSM/LM MEDICAL	TRC	222	1	IN LM TUNNEL	1.1	300.0	.0	.0
EQUIP. XFR. LM-CM 1					1.10	300.00	.00	.00

NOTE: Further information relating to this table is given on pages 3.4-19, 3.4-20 and 3.4-21.

Table 3.4-9.2 (Continued)

MISSION H-3 TRANSFERRED CREW AND EQUIPMENT STOWAGE LIST								
ITEMS TRANSFERRED FROM LM INTO CM AT LM ACTIVATION (10)								
DESCRIPTION	STOW. ITEM	REF	NO.	STOWAGE LOCATION	WEIGHT	APOLLO COORDINATES		
						X-C.G.	Y-C.G.	Z-C.G.
CSM/LM UMBILICAL	TBD	222	1	UNDER RH COUCH	1.1	1010.0	24.5	-15.0
EQUIP.XFR,LM-CM 1					1.10	1010.00	24.50	-15.00

NOTE: Further information relating to this table is given on pages 3.4-19, 3.4-20 and 3.4-21.

Table 3.4-9.2 (Continued)

MISSION M-3 TRANSFERRED CREW AND EQUIPMENT STORAGE LIST								
ITEMS OFFLOADED FROM ASC. STAGE PRIOR TO LUNAR LIFT-OFF (11)								
LM COORDINATES								
DESCRIPTION	STOW. ITEM	RFF	NO.	STOWAGE LOCATION	WEIGHT	X-C.G.	Y-C.G.	Z-C.G.
EAKPLUGS(PAIR)-CDR.	R0210.	111	1	CN PGA-CDR (DN CREW)	NEGL	250.6	-22.0	43.4
EAKPLUGS(PAIR)-LMP.	R0210.	111	1	CN PGA-LMP (DN CREW)	NEGL	250.6	22.0	43.4
BATTERY, PLSS	R1004.	111	2	LH SIDE STOW.COMPT.	11.0	235.0	-38.0	42.0
BRACKET, CAMERA MOUNT	R1001.1	115	1	ISA (OV. RECHAR. STAT)	.6	270.3	-15.0	19.0
JAG, CAMERA MOUNT, BRACKET	C3034.	115	1	ISA (OV. RECHAR. STAT)	.3	270.3	-15.0	19.0
FILTER, POLARIZING	A1005.	115	1	CN 60MM LENS (RHSSC)	.2	238.4	38.6	46.0
CAMERA, LS ELCT. FASSELBLAD	A1015.	115	1	RH SIDE STOW.COMPT.	3.1	238.4	38.6	43.0
LENS, 60 MM	A1016.	115	1	RF SIDE STOW.COMPT.	1.8	238.4	38.6	43.0
ADAPTER, ERKT, RT, ANGLE 16MM CAM	A1021.	115	1	LH SIDE STOW.COMPT.	.2	235.0	-38.0	42.0
CONTROL, ELECT. CONTRL, 16MM CAM.	A1022.	115	1	LH SIDE STOW.COMPT.	.7	235.0	-38.0	42.0
TRIGGER, ELECT. HASSELBLAD CAMERA	A1027.	115	1	RF SIDE STOW.COMPT.	.2	238.4	38.6	43.0
HANDLE, ELECT. HASSELBLAD CAMERA	A1028.	115	1	RF SIDE STOW.COMPT.	.5	238.4	38.6	43.0
TETHER, EVA RETRACTABLE-CDR.	A1029.	115	1	CN CDR PLSS (RECHG ST)	.2	262.8	-20.8	15.4
TETHER, EVA RETRACTABLE-LMP.	A1029.	115	1	CN LMP PLSS (CBN. FLR)	.2	219.7	.0	44.7
REMOTE CONTROL UNIT-PLSS	R1001.	115	2	CN MINUS 227 BHD-RCU	10.2	272.0	.0	-18.0
BOOTS, LUNAR (PR.)-CDR.	R1018.	115	1	UPR. BOOT BOX	4.5	280.8	-20.0	-9.5
BOOTS, LUNAR (PR.)-LMP.	R1018.	115	1	LWR. BOOT BOX	4.5	273.8	-20.0	-9.5
JAG ASSY, LFC + W.T.	R1020.1	115	1	LH SIDE STOW.COMPT.	.2	235.0	-38.0	42.0
CONVEYOR ASSY, LUNAR EQUIP (LFC)	R1020.2	115	1	LH SIDE STOW.COMPT.	1.3	235.0	-38.0	42.0
BAU, DEFLCY, LFC	R1020.3	115	1	LH SIDE STOW.COMPT.	.1	235.0	-38.0	42.0
PLSS/EVC ASSY-CDR.	R1024.	114	1	RECHARGE STA.-PLSS	83.1	262.8	-20.8	15.4
PLSS/EVC ASSY-LMP.	R1025.	114	1	ON CABIN FLOOR-PLSS	83.0	219.7	.0	44.7
JAG, JETTISON STORAGE	R1027.	115	1	LH SIDE STOW.COMPT.	.9	235.0	-38.0	42.0
TUNNELS, LM UTILITY (REC)	R1043.	115	2	LH SIDE STOW.COMPT.	.2	235.0	-38.0	42.0
TUNNELS, LM UTILITY (BLUF)	R1044.	115	2	LH SIDE STOW.COMPT.	.2	235.0	-38.0	42.0
BUDY SLSS ASSY	R1052.	116	1	CN PLUS 227 BHD	10.9	221.0	-1.0	29.5
CONTAINER, BUDY SLSS ASSY-STOW	C3059.	119	1	CN PLUS 227 BHC	3.1	221.0	-1.0	29.5
LM FOOD ASSY NO. 1 (2 2/3 M. DAY)	C1000.	115	1	FOOD CONTAINER NO.1	2.3	279.8	-20.0	.0
LM FOOD ASSY NO. 2 (2 2/3 M. DAY)	C1000.	115	1	FOOD CONTAINER NO.2	3.0	273.8	-20.0	.0
ADAPTER SRC/LPS	C3004.	115	1	CN OPSISRC RACK NC.1	2.4	257.4	-20.7	-6.0
ADAPTER SRC/LPS	C3004.	115	1	CN OPSISRC RACK NC.2	2.4	265.9	-20.7	-6.0
CANNISTER, ECS LICH	C7008.	115	1	AFT OF ASC. ENG. COVER	9.2	245.8	8.8	-15.0

NOTE: Further information relating to this table is given on pages 3.4-19, 3.4-20 and 3.4-21.

Table 3.4-9.2 (Continued)

MISSION H-3 TRANSFERRED CREW AND EQUIPMENT STOWAGE LIST								
ITEMS OFFLOADED FROM ASC. STAGE PRIOR TO LUNAR LIFT-OFF (11)								
DESCRIPTION	STOW. ITEM	REF	NO.	STOWAGE LOCATION	WEIGHT	LM COORDINATES		
						X-C.G.	Y-C.G.	Z-C.G.
URINE COLLECTION ASSY (SMALL)	03009.	115	1	RH SIDE STOW.COMPT.	.9	238.4	38.6	43.0
CONTAINER ASSY, DISPOSAL (LWR)	C3012.	115	2	LH SIDE STOW.COMPT.	3.6	235.0	-38.0	42.0
CONTAINER, PLSS CONDENSATE	C3014.	115	1	LH MID-SECTION	4.4	257.6	-18.0	-18.0
STRAP, FCS LIQH CANNISTER	G3024.	115	1	CANNISTER (REAR, AEC)	.1	250.0	8.8	-11.8
HAMMOCK ASSY-LDR.	C3049.	115	1	LH SIDE STOW.COMPT.	4.1	235.0	-38.0	42.0
HAMMOCK ASSY-LMP.	C3050.	115	1	LH SIDE STOW.COMPT.	3.9	235.0	-38.0	42.0
CONT. CONT. SAMPLE RETURN (EMPTY)	G4016.	115	1	LH SIDE STOW.COMPT.	.6	235.0	-38.0	42.0
ARM RESTS-CLH	TBD	346	2	RH CREW STATION-	2.2	260.0	22.0	45.0
ARM RESTS-LMP.	TRD	346	2	LH CREW STATION-	2.2	260.0	-22.0	45.0
JACOBO FM CAMERA-STWS.	C3062.	111	1	LH SIDE STOW.COMPT.	1.0	235.0	-38.0	42.0
3A TV SYSTEM	E1000.	111	1	LM MINUS 227 BHD-TV	7.6	288.5	.0	-22.6
COLLECTION BAG, CALH. PLSS FW	B1026.	111	1	LH SIDE STOW.COMPT.	.8	235.0	-38.0	42.0
COLLECTION BAG, CAL. PLSS FW WS	B1026.1	111	1	LH SIDE STOW.COMPT.	.5	235.0	-38.0	42.0
CAN./PCWR. PAK ASSY, 16MM L.S.	A1043.	111	1	LH SIDE STOW.COMPT.	8.9	235.0	-38.0	42.0
LEFT AT LUNAR SITE					281.30	244.68	-11.86	24.30

NOTE: Further information relating to this table is given on pages 3.4-19, 3.4-20 and 3.4-21.

Table 3.4-9.2 (Continued)

MISSION M-3 TRANSFERRED CREW AND EQUIPMENT STOWAGE LIST								
ITEMS UNLOADED INTO ASC. STAGE PRIOR TO LUNAR LIFT-OFF (12)								
DESCRIPTION	STOW. ITEM	REF	NO.	STOWAGE LOCATION	WEIGHT	LM COORDINATES		
						X-C.G.	Y-C.G.	Z-C.G.
SAMPLE CONTAINED, MAGNETIC SHLD	G4C39.	111	1	ISA(OVER AS ENG CVR)	1.0	280.0	.0	-10.0
SAMPLE CONT., SPECIAL ENVIRON.	G4040.	111	1	ISA(OVER AS ENG CVR)	1.0	280.0	.0	-10.0
CUNTR. SAMPL. NET. NO. 1 (LOADED)	G4003.	115	1	SRC RACK NO. 1-LWR.	65.0	257.4	-20.7	-6.0
CUNTR. SAMPL. NET. NO. 2 (LOADED)	G4004.	115	1	SRC RACK NO. 2-UPR.	65.0	265.9	-20.7	-6.0
S. & C. EXPERIMENT	G4C11.	115	1	ISA(OVER AS ENG CVR)	.3	280.0	.0	-10.0
CUNTR. CENT. SAMPL. RETRY (LOADED)	G4014.	115	1	ISA(OVER AS ENG CVR)	2.6	280.0	.0	-10.0
CASSSETTE, CLOSE-UP CAMFRA (GSC)	J1001.	115	1	ISA(OVER AS ENG CVR)	.5	280.0	.0	-10.0
BAG, SAMPLE RETURN	C3060.	111	1	PLUS Z27 BHD-ROCKS	35.0	221.2	2.2	29.5
BAG, LUNAR EQUIPMENT TRANSFER	C3018.	111	1	ISA(OVER AS ENG CVR)	.9	280.0	.0	-10.0
BAG, SOLAR WIND COMP. EXP.	G4C11.1	111	1	ISA(OVER AS ENG CVR)	TBD	280.0	.0	-10.0
WEIGH BAG WITH FOOTBALL SZ BK	G4018.	111	1	LHSSC (SAMPLE)	30.0	235.5	-32.6	42.4
WEIGH BAG WITH FOOTBALL SZ BK	G4C18.	111	1	ISA(OVER AS ENG CVR)	30.0	280.0	.0	-10.0
WEIGH BAG WITH SMALL ROCKS	G4018.	111	1	ISA(OVER AS ENG CVR)	15.0	280.0	.0	-10.0
UNLOAD AT LUN. SITE					246.31	256.54	-14.58	4.11

NOTE: Further information relating to this table is given on pages 3.4-19, 3.4-20 and 3.4-21.

Table 3.4-9.2 (Continued)

MISSION H-3 TRANSFERRED CREW AND EQUIPMENT STOWAGE LIST								
ITEMS REARRANGED IN LM PRIOR TO LUNAR LIFT-OFF (13)								
LM COORDINATES								
DESCRIPTION	STOW. ITEM	REF	NO.	STOWAGE LOCATION	WEIGHT	X-C.G.	Y-C.G.	Z-C.G.
MAGAZINE, INRM DATA ACQUISITION	A0101.1	111	1	EN CAM/RH WINDOW PKT	1.0	287.0	22.0	65.0
MAGAZINE, INRM DATA ACQUISITION	A0101.1	111	1	ISA(OV.RECHARGE,STAT)	1.0	270.3	-15.0	19.0
MAG, 70MM XFR, 15MM MAG.	C6393.	111	1	ISA(OV.RECHARGE,STAT)	.1	270.3	-15.0	19.0
MAGAZINE, 70MM L.S. HASSELBLAD	A0108.1	111	2	70MM XFR MAG(FHSSC)	2.8	236.4	38.6	46.0
INTERIM STOW. ASSY (ISA)	C3007.	114	* 1	ISA(OV.RECHARGE,STAT)	7.6	270.3	-15.0	19.0
BRACKET, CAMERA MOUNT	P1001.1	115	1	ISA(OV.RECHARGE,STAT)	.6	270.3	-15.0	19.0
DEVICE, IN-SUIT DRINKING	P1048.	114	2	ISA(OV.RECHARGE,STAT)	.2	270.3	-15.0	19.0
MAG, 70MM XFR, 15MM MAG.	P1060.	111	2	ISA(OV.RECHARGE,STAT)	.2	270.3	-15.0	19.0
SAMPLES, THERMAL COAT, DEGRADE	F1002.	111	2	ISA(OV.RECHARGE,STAT)	.8	270.3	-15.0	19.0
JAY GEN PURGE SYSTEMS)-CDR.	B1012.	115	1	SRC RACK NO.1-LWR.	25.7	257.4	-20.7	-6.0
JAY GEN PURGE SYSTEMS)-LMP.	P1012.	115	1	SRC RACK NO.2-UPP.	25.7	265.5	-20.7	-6.0
HELMET STOWAGE RACK-CDR.	B1013.	115	1	EN CABIN FLOOR	1.4	221.0	-18.3	53.0
LUNAR EVA VISOR (LEVA)	B1014.	115	1	HSB/LH(OV CABIN FLR)	4.2	221.0	-18.3	53.0
GLOVES, EV (PAIR)-CDR.	P1015.	115	1	HSB/LH(OV CABIN FLR)	2.2	221.0	-18.3	53.0
GLOVES, EV (PAIR)-LMP.	P1016.	115	1	HSB/LH(OV CABIN FLR)	.5	221.0	-18.3	53.0
PURGE VALVE ASSY-CDR.	P1017.	115	1	LUNAR OVERSHOES-UPR	.5	280.8	-20.0	-9.5
PURGE VALVE ASSY-LMP.	P1017.	115	1	LUNAR OVERSHOES-LWR	.5	273.8	-20.0	-9.5
LIFE LINE (LIGHT WEIGHT)	P1020.4	115	1	BAG ASY, LEC+WT(LHSSC)	.3	235.0	-34.0	45.0
MAG, DEPLOY, LIFE LINE	P1020.5	115	1	BAG ASY, LEC+WT(LHSSC)	.1	235.0	-34.0	45.0
TECHN, WAIST EVA	B1020.6	115	1	BAG ASY, LEC+WT(LHSSC)	.6	235.0	-34.0	45.0
TECHN, WAIST EVA	P1020.7	115	1	BAG ASY, LEC+WT(LHSSC)	.6	235.0	-34.0	45.0
STRAPS, ATTACH, PLESS, LOWER (LH)	P1021.	115	2	EN CDR PLESS(PFCHG ST)	.4	262.8	-20.8	15.4
STRAPS, ATTACH, PLESS, LOWER (RH)	P1022.	115	2	EN LMP PLESS(CRN, FLK)	.6	219.7	.0	44.7
LUNAR EVA VISOR (LEVA)	P1014.	115	1	HSB/LH(OV CABIN FLR)	4.2	221.0	-18.3	53.0
HELMLT STOWAGE RACK-LMP.	P1059.	111	1	EN CABIN FLOOR	1.4	221.0	-18.3	53.0
GLOVES, EV (PAIR)	P1057.	111	1	HSB/LH(OV CABIN FLR)	2.4	221.0	-18.3	53.0
MAG, 70MM MAG. (LM XFR)	C6430.	111	1	MF SIDE STOW.CCMPT.	.5	238.4	38.6	43.0
ELECTRICAL ASSY(ASA SHORT.PLG)	C3019.	111	1	ISA(OV.RECHARGE,STAT)	.1	270.3	-15.0	19.0
MAG, TEMPORARY STOWAGE	C3031.	111	1	ISA(OV.RECHARGE,STAT)	.9	270.3	-15.0	19.0
LM EQUIP. PELLIC?					107.10	255.43	-17.57	9.01

NOTE: Further information relating to this table is given on pages 3.4-19, 3.4-20 and 3.4-21.

Table 3.4-9.2 (Continued)

MISSION H-3 TRANSFERRED CREW AND EQUIPMENT STOWAGE LIST								
ITEMS REARRANGED IN LM PRIOR TO LUNAR LIFT-OFF (14)								
DESCRIPTION	STOW. ITEM	REF	NO.	STOWAGE LOCATION	WEIGHT	LM COORDINATES		
						X-C.G.	Y-C.G.	Z-C.G.
400 AZINE, 16MM DATA ACQUISITION	A0101.1	111	1	XFR BAG (ISA/OASE)	1.0	260.0	.0	2.2
400 AZINE, 16MM DATA ACQUISITION	A0101.1	111	1	ISA (OVER AS ENG CVR)	1.0	280.0	.0	-10.0
BAG, STOW, XFR, 16MM MAG.	C6393.	111	1	ISA (OVER AS ENG CVR)	.1	280.0	.0	-10.0
400 AZINE, 70MM L.S. MANSFLBLAD	A0108.1	111	2	ISA (OVER AS ENG CVR)	2.8	280.0	.0	-10.0
TRIPLEX STOW. ASSY (ISA)	C3007.	114	* 1	ISA (OVER AS ENG CVR)	7.6	280.0	.0	-10.0
BAGNET, CAMERA MOUNT	R1001.1	115	1	IN BRKT. BG (ISA/OASE)	.6	260.0	.0	2.2
DEVICE, IN-SUIT DRINKING	B1048.	114	2	ISA (OVER AS ENG CVR)	.2	280.0	.0	-10.0
BAG, STOWAGE, THERMAL SAMPLES	R1060.	111	2	ISA (OVER AS ENG CVR)	.2	280.0	.0	-10.0
SAMPLES, THERMAL COAT, DEGRADE	F1002.	111	2	ISA (OVER AS ENG CVR)	.8	280.0	.0	-10.0
DAY GEN PURGE SYSTEMS (PS)-CDR.	R1012.	115	1	CN CABIN FLOOR-OPS	35.7	219.7	.0	51.4
DAY GEN PURGE SYSTEMS (PS)-LMP.	R1012.	115	1	CN CABIN FLOOR-OPS	35.7	219.7	.0	51.4
HELMET STOWAGE BAG-CDR.	R1013.	115	1	HSR (ON ASC. ENG COVR)	1.4	260.0	-5.5	-1.5
LUNAR EVA VISOR (LEVA)	R1014.	115	1	HSR (ON ASC. ENG COVR)	4.2	260.0	-5.5	-1.5
GLOVES, EV (PAIR)-CDR.	R1015.	115	1	HSR (ON ASC. ENG COVR)	2.2	260.0	-5.5	-1.5
KIT, EMU MAINTENANCE	R1016.	115	1	HSR (ON ASC. ENG COVR)	.5	260.0	-5.5	-1.5
PURGE VALVE ASSY-CDR.	R1017.	115	1	RH SIDE STOW. COMPT.	.5	238.4	38.6	43.0
PURGE VALVE ASSY-LMP.	B1017.	115	1	RH SIDE STOW. COMPT.	.5	238.4	38.6	43.0
LIFE LINE (LIGHT WEIGHT)	B1020.4	115	1	LH SIDE STOW. COMPT.	.3	235.0	-38.0	42.0
BAG, DEPLOY. LIFE LINE	B1020.5	115	1	LH SIDE STOW. COMPT.	.1	235.0	-38.0	42.0
TETHER, WAIST EVA	R1020.6	115	1	LH SIDE STOW. COMPT.	.6	235.0	-38.0	42.0
TETHER, WAIST EVA	R1020.7	115	1	LH SIDE STOW. COMPT.	.6	235.0	-38.0	42.0
STRAPS, ATTACH, PLESS. LINER (LH)	R1021.	115	2	RH SIDE STOW. COMPT.	.4	238.4	38.6	43.0
STRAPS, ATTACH, PLESS. LINER (RH)	R1022.	115	2	RH SIDE STOW. COMPT.	.4	238.4	38.6	43.0
LUNAR EVA VISOR (LEVA)	R1014.	115	1	HSR (ON ASC. ENG COVR)	4.2	260.0	5.5	6.0
HELMET STOWAGE BAG-LMP.	F1058.	111	1	HSR (ON ASC. ENG COVR)	1.4	260.0	5.5	6.0
GLOVES, EV (PAIR)	F1057.	111	1	HSR (ON ASC. ENG COVR)	2.4	260.0	5.5	6.0
BAG, 70MM MAG. (LM XFR)	C6430.	111	1	ISA (OVER AS ENG CVR)	.5	280.0	.0	-10.0
ELECTRICAL ASSY (ASA SHORT. PLG)	C3019.	111	1	ISA (OVER AS ENG CVR)	.1	280.0	.0	-10.0
BAG, TEMPORARY STOWAGE	C3031.	111	1	ISA (OVER AS ENG CVR)	.9	280.0	.0	-10.0
LM EQUIP. PFLIC.					107.10	235.01	.14	34.74

NOTE: Further information relating to this table is given on pages 3.4-19, 3.4-20 and 3.4-21.

Table 3.4-9.2 (Continued)

MISSION H-3 TRANSFERRED CREW AND EQUIPMENT STOWAGE LIST								
ITEMS TRANSFERRED FROM ASC. STAGE INTO CM PRIOR TO ASC. STAGE JETTISON (15)								
LM COORDINATES								
DESCRIPTION	STOW. ITEM	REF	NO.	STOWAGE LOCATION	WEIGHT	X-C.G.	Y-C.G.	Z-C.G.
CREW-COMMANDER (CDR)	TBC	227	1	LM CREW STATION-	171.0	260.0	-22.0	45.0
CREW-LM PILOT (LMP)	TBC	227	1	RM CREW STATION-	185.0	260.0	22.0	45.0
TURSUOLIME SUIT ASSY, FV-CDR.	B0200.1	127	1	CA CREW(LH CREW STA)	38.6	260.0	-22.0	45.0
HELMET ASSY, PRESSURE-CDR.	B0200.2	127	1	CA CREW(LH CREW STA)	2.5	260.0	-22.0	45.0
GLOVES, IV (PAIR)-CDR.	H0200.3	127	1	CA CREW(LH CREW STA)	1.6	260.0	-22.0	45.0
COMMUNICATIONS CARRIER-CDR.	H0200.4	127	1	CA CREW(LH CREW STA)	1.6	260.0	-22.0	45.0
POCKET, CHECKLIST+SCISSORS-CDR.	P0200.5	167	1	CA PGA-CDP (ON CREW)	.2	250.6	-22.0	43.4
POCKET, CHECKLIST-CDR.	P0200.6	167	1	CA PGA-CDP (ON CREW)	.2	250.6	-22.0	43.4
JUTA-CDR.	H0205.	117	1	CA CREW(LH CREW STA)	.5	260.0	-22.0	45.0
BLU INSTRUMENTATION-CDR.	C0201.	111	1	CA CREW(LH CREW STA)	1.1	260.0	-22.0	45.0
JACKET, LIQUID COOLING - CDR.	R0107.	111	1	CA CREW(LH CREW STA)	5.0	260.0	-22.0	45.0
EARPIECE, MOUTH (COM. CARR)-CDR.	F0200.1	111	1	CA CREW(LH CREW STA)	NEGL	260.0	-22.0	45.0
EARTUBE (COM. CARRIER)-CDR.	F0200.2	111	1	CA CREW(LH CREW STA)	NEGL	260.0	-22.0	45.0
SUNGLASSES-CDR.	A0200.	117	1	CA CREW(LH CREW STA)	.1	260.0	-22.0	45.0
POCKET, SUNGLASSES-CDR.	A0201.	117	1	CA CREW(LH CREW STA)	NEGL	260.0	-22.0	45.0
CHARCOALGRAPH-CDR.	A0202.	117	1	CA CREW(LH CREW STA)	.1	260.0	-22.0	45.0
DATACHAND-CDR.	A0203.	117	1	CA CREW(LH CREW STA)	NEGL	260.0	-22.0	45.0
PEN, SLATA RECORDING-CDR.	AC204.	117	1	CA CREW(LH CREW STA)	.1	260.0	-22.0	45.0
PEN, MARKER-CDR.	A0205.	117	1	CA CREW(LH CREW STA)	NEGL	260.0	-22.0	45.0
PENCIL-CDR.	A0206.	117	1	CA CREW(LH CREW STA)	.1	260.0	-22.0	45.0
PENLIGHTS-CDR.	H0206.	117	1	CA CREW(LH CREW STA)	.3	260.0	-22.0	45.0
HELBELT ASSY-CDR.	H0207.	117	1	CA CREW(LH CREW STA)	.2	260.0	-22.0	45.0
DUSTMETER, PERSONAL-CDR.	D0200.	117	1	CA CREW(LH CREW STA)	.4	260.0	-22.0	45.0
JUSTMETER, PASSIVE-CDR.	D0201.	117	1	CA CREW(LH CREW STA)	NEGL	260.0	-22.0	45.0
TURSUOLIME SUIT ASSY, FV-LMP.	B0200.1	127	1	CA CREW(RH CREW STA)	38.6	260.0	22.0	45.0
HELMET ASSY, PRESSURE-LMP.	B0200.2	127	1	CA CREW(RH CREW STA)	2.5	260.0	22.0	45.0
GLOVES, IV (PAIR)-LMP.	H0200.7	127	1	CA CREW(RH CREW STA)	1.6	260.0	22.0	45.0
COMMUNICATIONS CARRIER-LMP.	H0200.4	127	1	CA CREW(RH CREW STA)	1.6	260.0	22.0	45.0
POCKET, CHECKLIST+SCISSORS-LMP.	H0200.5	167	1	CA PGA-LMP (ON CREW)	.2	250.6	22.0	43.4
POCKET, CHECKLIST-LMP.	H0200.6	167	1	CA PGA-LMP (ON CREW)	.2	250.6	22.0	43.4
JUTA-LMP.	P0205.	117	1	CA CREW(LH CREW STA)	.5	260.0	22.0	45.0
BLU INSTRUMENTATION-LMP.	C0201.	111	1	CA CREW(RH CREW STA)	1.1	260.0	22.0	45.0

NOTE: Further information relating to this table is given on pages 3.4-19, 3.4-20 and 3.4-21.

Table 3.4-9.2 (Continued)

MISSION H-3 TRANSFERRED CREW AND EQUIPMENT STOWAGE LIST								
ITEMS TRANSFERRED FROM ASC. STAGE INTO CM PRIOR TO ASC. STAGE JETTISON (15)								
LM COORDINATES								
DESCRIPTION	STOW. ITEM	REF	NO.	STOWAGE LOCATION	WEIGHT	X-C.G.	Y-C.G.	Z-C.G.
GARMENT, LIQUID COOLING - LMP.	E0107.	111	1	LN CREW(RH CREW STA)	5.0	260.0	22.0	45.0
EAK PLECE, MOLDED (COM. CARR.) LMP.	E0200.1	111	1	LN CREW(PH CREW STA)	NEGL	260.0	22.0	45.0
EAK TUBE (COMM. CARRIER) - LMP.	E0200.2	111	1	LN CREW(RH CREW STA)	NEGL	260.0	22.0	45.0
SUNGLASSES - LMP.	A0200.	117	1	LN CREW(RH CREW STA)	.1	260.0	22.0	45.0
POUCH, SUNGLASSES - LMP.	A0201.	117	1	LN CREW(RH CREW STA)	NEGL	260.0	22.0	45.0
CHOKUNGGRAPH - LMP.	A0202.	117	1	LN CREW(RH CREW STA)	.1	260.0	22.0	45.0
WATCHBAND - LMP.	A0203.	117	1	LN CREW(RH CREW STA)	NEGL	260.0	22.0	45.0
PENS, DATA RECODING - LMP.	A0204.	117	1	LN CREW(RH CREW STA)	.1	260.0	22.0	45.0
PENS, MARKER - LMP.	A0205.	117	1	LN CREW(RH CREW STA)	NEGL	260.0	22.0	45.0
PENCIL - LMP.	A0206.	117	1	LN CREW(PH CREW STA)	.1	260.0	22.0	45.0
PENLIGHTS - LMP.	P0206.	117	1	LN CREW(PH CREW STA)	.3	260.0	22.0	45.0
BIBELT ASSY - LMP.	P0207.	117	1	LN CREW(RH CREW STA)	.2	260.0	22.0	45.0
DUSIMETER, PERSONAL - LMP.	D0200.	117	1	LN CREW(RH CREW STA)	.4	260.0	22.0	45.0
DUSIMETER, PASSIVE - LMP.	C0201.	117	1	LN CREW(PH CREW STA)	NEGL	260.0	22.0	45.0
LM ACTIVATION CHECKLIST	A0114.12	114	1	LM XFR DATA CARD KIT	.5	280.8	-20.0	14.0
LM L.S. CHECKLIST	A0114.10	114	1	LM XFR DATA CARD KIT	1.0	280.8	-20.0	14.0
LM SYSTEMS ACTIVATION CHECKLIST	A0114.12	114	1	LM XFR DATA CARD KIT	.5	280.8	-20.0	14.0
LM TIMELINE BOOK	A0114.14	114	1	LM XFR DATA CARD KIT	.5	280.8	-20.0	14.0
LM XFR DATA CARD KIT	A0114.18	114	1	FLIGHT DATA FILE CTR	.6	280.8	-20.0	14.0
LM DATA CARD BOOK	A0114.19	114	1	LM XFR DATA CARD KIT	.3	280.8	-20.0	14.0
LM ORBIT MONITOR CHART	A0114.22	114	1	LM XFR DATA CARD KIT	.3	280.8	-20.0	14.0
DUSIMETER, PASSIVE RADIATION	D0101.	111	1	16MM MAG BAG(RHSSC)	NEGL	238.4	38.6	46.0
SLISSURS	B0204.	111	1	LN CREW(LH CREW STA)	.5	260.0	-22.0	45.0
BAG, STCW+XFR, 16MM MAG.	D0380.	111	1	RH SIDE STOW.COMPT.	.3	238.4	38.6	43.0
BAG, 70 MM MAG(LM XFR)	D0381.	111	1	RH SIDE STOW.COMPT.	.5	238.4	38.6	43.0
MAGAZINE, 16MM DATA ACQUISITION	A0101.1	111	1	XFR BAG(ISA/OASE)	1.0	260.0	.0	2.2
MAGAZINE, 16MM DATA ACQUISITION	A0101.1	111	1	XFR BAG(ISA/OASE)	1.0	260.0	.0	2.2
MAGAZINE, 16MM DATA ACQUISITION	A0101.1	111	6	XFR BAG (RHSSC)	6.0	238.4	38.6	46.0
BAG, STCW+XFR, 16MM MAG.	C0393.	111	1	ISA(OVER AS ENG CVR)	.1	280.0	.0	-10.0
MAGAZINE, 70 MM L.S. HASSEL.	A0108.1	111	2	RH SIDE STOW.COMPT.	4.2	238.4	38.6	43.0
MAGAZINE, 70MM L.S. HASSELBLAD	A0108.1	111	2	RH SIDE STOW.COMPT.	2.8	238.4	38.6	43.0
SUBSYSTEM, FFICAL CONTAINMENT-CDR	E0113.	117	1	LN CREW(LH CREW STA)	.3	260.0	-22.0	45.0

NOTE: Further information relating to this table is given on pages 3.4-19, 3.4-20 and 3.4-21.

Table 3.4-9.2 (Continued)

MISSION H-3 TRANSFERRED CREW AND EQUIPMENT STOWAGE LIST								
ITEMS TRANSFERRED FROM ASC. STAGE INTO CM PRIOR TO ASC. STAGE JETTISON (15)								
LM COORDINATES								
DESCRIPTION	STOW. ITEM	REF	NO.	STOWAGE LOCATION	WEIGHT	X-C.G.	Y-C.G.	Z-C.G.
SUBSYSTEM, LOCAL CONTAINMENT-LMP	P0113.	117	1	LN CREW (RH CREW STA)	.3	260.0	22.0	45.0
INTERIM STOW. ASSEY (ISA)	C3007.	114	* 1	OVER AS ENG. COVER	7.6	260.0	.0	2.2
BRACKET, CAMERA MOUNT	P1001.1	115	1	IN BKKT. HG (ISA/DASE)	.6	260.0	.0	2.2
BAG, STOWAGE, THERMAL SAMPLES	B1060.	111	2	ISA (OVER AS ENG CVR)	.2	280.0	.0	-10.0
SAMPLES, THERMAL COAT. DEGRADE	F1002.	111	2	ISA (OVER AS ENG CVR)	.8	280.0	.0	-10.0
CAMERA, LS ELECT. HASSELBLAD	A1015.	115	1	RH SIDE STOW. COMPT.	3.1	238.4	38.6	43.0
LENS, 60 MM	A1016.	115	1	RH SIDE STOW. COMPT.	1.8	238.4	38.6	43.0
TRIGGER, ELECT. HASSELBLAD CAMPA	A1027.	115	1	RH SIDE STOW. COMPT.	.2	238.4	38.6	43.0
HANDLE, ELECT. HASSELBLAD CAMERA	A1028.	115	1	RH SIDE STOW. COMPT.	.5	238.4	38.6	43.0
SAMPLE CONTAINER, MAGNETIC SHLD	G4039.	111	1	ISA (OVER AS ENG CVR)	1.0	280.0	.0	-10.0
SAMPLE CONT., SPECIAL ENVIRON.	G4040.	111	1	ISA (OVER AS ENG CVR)	1.0	280.0	.0	-10.0
CONTNR. SAMP. RET. NO. 1 (LOADED)	G4003.	115	1	SFC RACK NO. 1-LWR.	65.0	257.4	-20.7	-6.0
CONTNR. SAMP. RET. NO. 2 (LOADED)	G4004.	115	1	SFC RACK NO. 2-UPR.	65.0	265.9	-20.7	-6.0
SAMPLE EXPERIMENT	G4011.	115	1	ISA (OVER AS ENG CVR)	.3	280.0	.0	-10.0
CONTNR. CONT. SAMP. RETRY (LOADED)	G4016.	115	1	ISA (OVER AS ENG CVR)	2.6	280.0	.0	-10.0
LA LUNAR SURFACE MAPS	A1008.5	111	1	FLIGHT DATA FILE CTR	1.7	280.8	-20.0	14.0
CASSETTE, CLOSE-UP CAM (FAICSC)	J1001.	115	1	ISA (OVER AS ENG CVR)	.5	280.0	.0	-10.0
LM RENDEZVOUS CHARTS	A1008.6	111	1	FLIGHT DATA FILE CTR	.5	280.8	-20.0	14.0
KIT, PILOTS PREFERENCE (PPK)	A1007.	115	2	RH SIDE STOW. COMPT.	1.0	238.4	38.6	43.0
KIT, PILOTS PREFERENCE (PPK)	A1007.	115	1	LH SIDE STOW. COMPT.	.5	235.0	-38.0	42.0
FLAG KIT, STANDARD	N1002.	166	1	LH SIDE STOW. COMPT.	.9	235.0	-38.0	42.0
300-0-0	C3005.	115	1	LN PLUS 227 BHD	2.3	221.0	-1.0	29.5
BAG, SAMPLE RETURN	F3060.	111	1	PLUS 227 BHD-ROCKS	35.0	221.2	2.2	29.5
BAG, 70MM FILM (LM XFR)	O6430.	111	1	ISA (OVER AS ENG CVR)	.5	280.0	.0	-10.0
BAG, LUNAR EQUIPMENT TRANSFER	C3018.	111	1	ISA (OVER AS ENG CVR)	.9	280.0	.0	-10.0
BAG, SOLAR WIND COMP. EXP.	G4011.1	111	1	ISA (OVER AS ENG CVR)	TRD	280.0	.0	-10.0
WEIGH BAG WITH FOOTBALL SIZ RK	G4018.	111	1	LHSSC (SAMPLE)	30.0	235.5	-32.6	42.4
WEIGH BAG WITH FOOTBALL SIZ RK	G4018.	111	1	ISA (OVER AS ENG CVR)	30.0	280.0	.0	-10.0
WEIGH BAG WITH SMALL POLKS	G4019.	111	1	ISA (OVER AS ENG CVR)	15.0	280.0	.0	-10.0
2 CREW EQUIP. 14-CM					750.61	258.31	-3.57	30.55

NOTE: Further information relating to this table is given on pages 3.4-19, 3.4-20 and 3.4-21.

Table 3.4-9.2 (Continued)

MISSION M-3 TRANSFERRED CREW AND EQUIPMENT STORAGE LIST								
ITEMS TRANSFERRED FROM ASC. STAGE INTO CM PRIOR TO ASC. STAGE JETTISON (16)								
APOLLO COORDINATES								
DESCRIPTION	STCW. ITEM	REF	NO.	STORAGE LOCATION	WEIGHT	X-C.G.	Y-C.G.	Z-C.G.
CREW-COMMANDER (CDR)	TBD	227	1	CA COUCH(CTR CREW STA	171.0	1043.0	.0	-10.4
CREW-LM PILOT (LMP)	TBD	227	1	CA COUCH(RH CREW STA	185.0	1043.0	24.5	-10.4
TURSU+LIME SUIT ASSY, EV-CDR.	B0200.1	127	1	CA CREW-CDR(CTR STA)	38.6	1043.0	.0	-10.4
HELMET ASSY, PRESSURE-CDR.	H0200.2	127	1	CA CREW-CDR(CTR STA)	2.5	1043.0	.0	-10.4
GLOVES, IV (PAIR)-CDR.	H0200.3	127	1	CA CREW-CDR(CTR STA)	1.6	1043.0	.0	-10.4
COMMUNICATION CARRIER-CDR.	B0200.4	127	1	CA CREW-CDR(CTR STA)	1.6	1043.0	.0	-10.4
PCKET, CHECKLIST+SCISSORS-CDR.	B0200.5	167	1	CA PGA(CREW-CTR STA)	.2	1043.0	.0	-10.4
PCKET, CHECKLIST-CDR.	H0200.6	167	1	CA PGA(CREW-CTR STA)	.2	1043.0	.0	-10.4
JLT A-CDR.	F0205.	117	1	CA CREW-CDR(CTR STA)	.5	1043.0	.0	-10.4
ALT INSTRUMENTATION-CDR.	C0201.	111	1	CA CREW-CDR(CTR STA)	1.1	1043.0	.0	-10.4
GARMENT, LIQUID COOLING - CDR.	H0107.	111	1	CA CREW-CDR(CTR STA)	5.0	1043.0	.0	-10.4
EARPIECE, POLYETHYLENE CARRI-CDR.	F0200.1	111	1	CA CREW-CDR(CTR STA)	NEGL	1043.0	.0	-10.4
EAR TUBE (CCM. CARRIER)-CDR.	F0200.2	111	1	CA CREW-CDR(CTR STA)	NEGL	1043.0	.0	-10.4
SUNGLASSES-C DR.	A0200.	117	1	CA CREW-CDR(CTR STA)	.1	1043.0	.0	-10.4
PUUCH, SUNGLASSES-CDR.	A0201.	117	1	CA CREW-CDR(CTR STA)	NEGL	1043.0	.0	-10.4
CHURCH MICROPH-CDR.	A0202.	117	1	CA CREW-CDR(CTR STA)	.1	1043.0	.0	-10.4
WATCHBAND-CDR.	A0203.	117	1	CA CREW-CDR(CTR STA)	NEGL	1043.0	.0	-10.4
PEN, DATA RECORDING-CDR.	AC204.	117	1	CA CREW-CDR(CTR STA)	.1	1043.0	.0	-10.4
PEN, MARKER-CDR.	A0205.	117	1	CA CREW-CDR(CTR STA)	NEGL	1043.0	.0	-10.4
PENCIL-CDR.	A0206.	117	1	CA CREW-CDR(CTR STA)	.1	1043.0	.0	-10.4
REF LIGHTS-CDR.	B0206.	117	1	CA CREW-CDR(CTR STA)	.3	1043.0	.0	-10.4
BELT ASSY-CDR.	B0207.	117	1	CA CREW-CDR(CTR STA)	.2	1043.0	.0	-10.4
JUMPTEN, PERSONAL-CDR.	D0200.	117	1	CA CREW-CDR(CTR STA)	.4	1043.0	.0	-10.4
JUMPTEN, PASSIVE-CDR.	D0201.	117	1	CA CREW-CDR(CTR STA)	NEGL	1043.0	.0	-10.4
TURSU+LMP SUIT ASSY, EV-LMP.	B0200.1	127	1	CA CREW-LMP(RH STA)	38.6	1043.0	24.5	-10.4
HELMET ASSY, PRESSURE-LMP.	H0200.2	127	1	CA CREW-LMP(RH STA)	2.5	1043.0	24.5	-10.4
GLOVES, IV (PAIR)-LMP.	H0200.7	127	1	CA CREW-LMP(RH STA)	1.8	1043.0	24.5	-10.4
COMMUNICATIONS CARRIER-LMP.	B0200.4	127	1	CA CREW-LMP(RH STA)	1.6	1043.0	24.5	-10.4
PCKET, CHECKLIST+SCISSORS-LMP.	H0200.5	167	1	CA PGA (CREW-RH STA)	.2	1043.0	24.5	-10.4
PCKET, CHECKLIST-LMP.	B0200.6	167	1	CA PGA (CREW-RH STA)	.2	1043.0	24.5	-10.4
JLT A-LMP.	F0205.	117	1	CA CREW-LMP(RH STA)	.5	1043.0	24.5	-10.4
ALT INSTRUMENTATION-LMP.	C0201.	111	1	CA CREW-LMP(RH STA)	1.1	1043.0	24.5	-10.4

NOTE: Further information relating to this table is given on pages 3.4-19, 3.4-20 and 3.4-21.

Table 3.4-9.2 (Continued)

MISSION H-3 TRANSFERRED CREW AND EQUIPMENT STOWAGE LIST								
ITEMS TRANSFERRED FROM ASC. STAGE INTO CM PRICP TO ASC. STAGE JETTISON (16)								
APCLLT COORDINATES								
DESCRIPTION	STCW. ITEM	REF	NO.	STOWAGE LOCATION	WEIGHT	X-C.G.	Y-C.G.	Z-C.G.
CLOTHING, LIQUID COOLING - LMP.	B0107.	111	1	CA CREW-LMP(RH STA)	5.0	1043.0	24.5	-10.4
EARPIECE, MOLDED (COM. CARTR.) LMP.	F0200.1	111	1	CA CREW-LMP(RH STA)	NEGL	1043.0	24.5	-10.4
EARTUBE (COMM. CARRIER)-LMP.	E0200.2	111	1	CA CREW-LMP(RH STA)	NEGL	1043.0	24.5	-10.4
SUNGLASSES-LMP.	A0200.	117	1	CA CREW-LMP(RH STA)	.1	1043.0	24.5	-10.4
POUCH, SUNGLASSES-LMP.	A0201.	117	1	CA CREW-LMP(RH STA)	NEGL	1043.0	24.5	-10.4
CHRONOGRAPH-LMP.	A0202.	117	1	CA CREW-LMP(RH STA)	.1	1043.0	24.5	-10.4
WATCH BAND-LMP.	A0203.	117	1	CA CREW-LMP(RH STA)	NEGL	1043.0	24.5	-10.4
PEN, DATA RECORDING-LMP.	A0204.	117	1	CA CREW-LMP(RH STA)	.1	1043.0	24.5	-10.4
PEN, MARKER-LMP.	A0205.	117	1	CA CREW-LMP(RH STA)	NEGL	1043.0	24.5	-10.4
PENCIL-LMP.	A0206.	117	1	CA CREW-LMP(RH STA)	.1	1043.0	24.5	-10.4
PENLIGHTS-LMP.	P0206.	117	1	CA CREW-LMP(RH STA)	.3	1043.0	24.5	-10.4
3/16 BELT ASSY-LMP.	R0207.	117	1	CA CREW-LMP(RH STA)	.2	1043.0	24.5	-10.4
DOSIMETER, PERSONAL-LMP.	D0200.	117	1	CA CREW-LMP(RH STA)	.4	1043.0	24.5	-10.4
DOSIMETER, PASSIVE-LMP.	D0201.	117	1	CA CREW-LMP(RH STA)	NEGL	1043.0	24.5	-10.4
LM ACTIVATION CHECKLIST	A0114.12	114	1	IN FDF (R3)	.5	1072.0	26.0	9.0
LM L.S. CHECKLIST	A0114.10	114	1	IN FDF (R3)	1.0	1072.0	26.0	9.0
LM SYSTEMS ACTIVATION CHECKLIST	A0114.12	114	1	IN FDF (R3)	.5	1072.0	26.0	9.0
LM TIMELINE BOOK	A0114.14	114	1	IN FDF (R3)	.5	1072.0	26.0	9.0
LM XFR DATA (AKD KIT)	A0114.18	114	1	IN FDF (R3)	.6	1072.0	26.0	9.0
LM DATA CARD BOOK	A0114.19	114	1	IN FDF (R3)	.3	1072.0	26.0	9.0
LM ORBIT MONITOR CHART	A0114.22	114	1	IN FDF (R3)	.3	1072.0	26.0	9.0
DOSIMETER, PASSIVE RADIATION SCISSORS	D0101. P0204.	111	1	16MM MAG BAG (R13) CA CREW-COPICTR. STA)	NEGL .5	1024.0 1043.0	45.0 .0	-26.0 -10.4
BAG, STCW XFR, 16MM MAG.	C0300.	111	1	AWEA R13	.3	1024.0	45.0	-26.0
BAG, 70 MM MAG (LM XFR)	C0301.	111	1	AKFA R13	.5	1024.0	45.0	-26.0
MAGAZINE, 16MM DATA ACQUISITION	A0101.1	111	1	XFR+STOW BG, 16MM (P1)	1.0	1050.0	-27.0	39.0
MAGAZINE, 16MM DATA ACQUISITION	A0101.1	111	1	XFR+STOW BG, 16MM (P1)	1.0	1050.0	-27.0	39.0
MAGAZINE, 16MM DATA ACQUISITION	A0101.1	111	6	XFR BG/DECON. BG (R13)	6.0	1024.0	45.0	-26.0
BAG, STCW XFR, 16MM MAG.	C0303.	111	1	AKFA R1	.1	1050.0	-27.0	39.0
MAGAZINE, 70 MM L.S. HASSEL.	A0108.1	111	3	AWEA R13	4.2	1024.0	45.0	-26.0
MAGAZINE, 70MM L.S. HASSELBLAD	A0108.1	111	2	XFR BG/DECON. BG (R13)	2.8	1024.0	45.0	-26.0
SUBSYSTEM, FIFAL CONTAINMENT-COR	H0113.	117	1	CA CREW-COPICTR. STA)	.3	1043.0	.0	-10.4

NOTE: Further information relating to this table is given on pages 3.4-19, 3.4-20 and 3.4-21.

Table 3.4-9.2 (Continued)

MISSION H-3 TRANSFERRED CREW AND EQUIPMENT STOWAGE LIST								
ITEMS TRANSFERRED FROM ASC. STAGE INTO CM PRIOR TO ASC. STAGE JETTISON (16)								
APOLLO COORDINATES								
DESCRIPTION	STOW. ITEM	REF	NO.	STOWAGE LOCATION	WEIGHT	X-C.G.	Y-C.G.	Z-C.G.
SUBSYSTEM, FECAL CONTAINMENT-LMP	HC113.	117	1	LN CREW-LMP (RH ST2)	.3	1043.0	24.5	-10.4
INTERIM STOW. ASSY (ISA)	C3007.	114	* 1	IN DECONT. RG (ON A1)	7.6	1012.0	-22.0	-26.0
PACKET, CAMERA MOUNT	P1001.1	115	1	ISA (DECON. BG/ON A1)	.6	1012.0	-22.0	-26.0
TAU, STOWAGE, THERMAL SAMPLES	F1060.	111	2	IA DECONT. RG (ON A1)	.2	1012.0	-22.0	-26.0
SAMPLES, THERMAL COAT. OF GRADE	F1002.	111	2	IA DECONT. RG (ON A1)	.8	1012.0	-22.0	-26.0
CAMERA, LS ELECT. HASSELBLAD	A1015.	115	1	ISA (DECON. BG/ON A1)	3.1	1012.0	-22.0	-26.0
LENS, 60 MM	A1016.	115	1	AREA A1	1.8	1012.0	-22.0	-26.0
TRIGGER, ELECT. HASSELBLAD CAMERA	A1027.	115	1	ISA (DECON. BG/ON A1)	.2	1012.0	-22.0	-26.0
HANDLE, ELECT. HASSELBLAD CAMERA	A1028.	115	1	ISA (DECON. BG/ON A1)	.5	1012.0	-22.0	-26.0
SAMPLE CONTAINER, MAGNETIC SHLD	G4039.	111	1	ISA (DECON. BG/ON A1)	1.0	1012.0	-22.0	-26.0
SAMPLE CONT., SPECIAL ENVIRON.	G4040.	111	1	ISA (DECON. BG/ON A1)	1.0	1012.0	-22.0	-26.0
CONTIN. SAMPL. RET. NO. 1 (LOADED)	G4003.	115	1	AREA B5	65.0	1031.0	-8.0	39.0
CONTIN. SAMPL. RET. NO. 2 (LOADED)	G4004.	115	1	AREA B6	65.0	1031.0	13.0	39.0
SOLAR EXPERIMENT	G4011.	115	1	ISA (DECON. BG/ON A1)	.3	1012.0	-22.0	-26.0
CONTIN. CONT. SMPL. RETRN (LOADED)	G4016.	115	1	BAG, RETURN EQUIP (B1)	2.6	1050.0	-27.0	39.0
LM LUNAR SURFACE MAPS	A1008.5	111	1	VOLUME CENTROID CM	1.7	1040.6	.0	.0
CASSETTE, CLOSE-UP CAMERA (CSC)	J1001.	115	1	BAG, RETURN EQUIP (B1)	.5	1050.0	-27.0	39.0
LM REVERSE/VOUS CHARTS	A1008.6	111	1	VOLUME CENTROID CM	.5	1040.6	.0	.0
K11, PILOTS PREFERENCE (PPK)	A1007.	115	2	AVFA R13	1.0	1024.0	45.0	-26.0
K11, PILOTS PREFERENCE (PPK)	A1007.	115	1	CARB FN FLTR BG (A13)	.5	1010.0	-22.0	-2.0
FLAG KIT, STANDARD	N1002.	166	1	CARB FN FLTR RG (A13)	.9	1010.0	-22.0	-2.0
D.S.C.A.	C3005.	115	1	AREA R13	2.3	1024.0	45.0	-26.0
BAG, SAMPLE RETURN	C3060.	111	1	CA CONTAINER A10	35.0	1011.0	23.0	6.0
BAG, 7CM MAG. (LM XFF)	C6430.	111	1	AREA R13	.5	1024.0	45.0	-26.0
BAG, LUNAR EQUIPMENT TRANSFER	C3018.	111	1	ISA (DECON. BG/ON A1)	.9	1012.0	-22.0	-26.0
BAG, SOLAR WIND COMP. EXP.	G4011.1	111	1	AREA A1	780	1012.0	-22.0	-26.0
WEIGH BAG WITH FOOTBALL SIZE RK	G4018.	111	1	AREA A13	30.0	1010.0	-22.0	-2.0
WEIGH BAG WITH FOOTBALL SIZE RK	G4018.	111	1	ISA (DECON. BG/ON A1)	30.0	1012.0	-22.0	-26.0
WEIGH BAG WITH SMALL ROCKS	G4018.	111	1	ISA (DECON. BG/ON A1)	15.0	1012.0	-22.0	-26.0
CREW EQUIP, LM-CM					750.61	1035.10	7.51	-1.94

NOTE: Further information relating to this table is given on pages 3.4-19, 3.4-20 and 3.4-21.

Table 3.4-9.2 (Continued)

MISSION H-3 TRANSFERRED CREW AND EQUIPMENT STORAGE LIST								
ITEMS TRANSFERRED FROM CM INTO ASC. STAGE PRIOR TO ASC. STAGE JETTISON (17)								
APOLLO COORDINATES								
DESCRIPTION	STOW. ITEM	FFF	NO.	STOWAGE LOCATION	WEIGHT	X-C.G.	Y-C.G.	Z-C.G.
CSM/LM LMPHICAL	THC	222	1	UNDER WH COUCH	1.1	1018.0	24.5	-15.0
BRUSH, VACUUM	B0139.	111	1	IN BAGION A8)	.4	1018.0	22.0	-23.0
MUSE, VACUUM	C6332.	111	1	VAC. HOSE BG(SIDE A8)	2.3	1012.0	22.0	-23.0
BAG, JETTISON. STORAGE	R0147.	111	1	AREA R13	.9	1024.0	45.0	-26.0
CO2 ABSORBERS (USED)	C0327.	121	4	AREA B5	26.8	1031.0	-8.0	39.0
CO2 ABSORBERS (USED)	C0327.	121	4	AREA B6	26.8	1031.0	13.0	39.0
SHAM, CO2 ABSORBERS (USED)	C0328.	161	4	AREA B5	.8	1031.0	-8.0	39.0
SHAM, CO2 ABSORBERS (USED)	C0328.	161	4	AREA B6	.8	1031.0	13.0	39.0
CONTAINER, IS	C0342.	111	1	AREA B5	14.5	1031.0	-8.0	39.0
CONTAINER, IS	C0342.	111	1	AREA B6	14.5	1031.0	13.0	39.0
DUCKING MECHANISM AND PROBE	C0343.	222	1	IN CM TUNNEL	193.5	1110.3	.0	.0
COUPLER, PG2 (2 UPR. INTERCON.)	C0351.	116	1	AREA A1	.4	1012.0	-22.0	-26.0
BAG CAMERA - HATCH HRT	C6437.	111	1	IN CM PGA CONTAINER	.5	1011.0	.0	-14.0
EQUIPMENT TOTAL					283.30	1084.86	1.16	11.17

NOTE: Further information relating to this table is given on pages 3.4-19, 3.4-20 and 3.4-21.

Table 3.4-9.2 (Continued)

MISSION M-3 TRANSFERRED CREW AND EQUIPMENT STORAGE LIST								
ITEMS TRANSFERRED FROM CM INTO ASC. STAGE PRIOR TO ASC. STAGE JETTISON (18)								
LM COORDINATES								
DESCRIPTION	STOW. ITEM	REF	NO.	STORAGE LOCATION	WEIGHT	X-C.G.	Y-C.G.	Z-C.G.
CSM/LM UMBILICAL	TBC	222	1	IN LM TUNNEL	1.1	300.0	.0	.0
BRUSH, VACUUM	B0139.	111	1	ON VACUUM HOSE	.4	233.0	-3.0	63.0
HOSE, VACUUM	C6332.	111	1	IN CONTAIN./FWD MTCH	2.3	233.0	-3.0	63.0
BAU, JETTISON STORAGE	B0147.	111	1	UNDER LMSSC	.9	236.5	-35.0	46.0
CO ₂ ABSORBERS (USED)	C0327.	121	4	SRC RACK NO.1-LWR.	26.8	257.4	-20.7	-6.0
CO ₂ ABSORBERS (USED)	C0327.	121	4	SRC RACK NO.2-UPR.	26.8	265.9	-20.7	-6.0
SHM, CO ₂ ABSORBERS (USED)	D0328.	161	4	SRC RACK NO.1-LWR.	.8	257.4	-20.7	-6.0
SHM, CO ₂ ABSORBERS (USED)	D0328.	161	4	SRC RACK NO.2-UPR.	.8	265.9	-20.7	-6.0
CONTAINER, B5	C0342.	111	1	SRC RACK NO.1-LWR.	14.5	257.4	-20.7	-6.0
CONTAINER, H6	C0343.	111	1	SRC RACK NO.2-UPR.	14.5	265.9	-20.7	-6.0
COUPL.ASY, PCA O2 UMB. INTERCON.	C0351.	116	1	IN CONTAIN./FWD MTCH	.4	233.0	-3.0	63.0
DULKING PROBE	D0349.	222	1	CM CABIN FLOOR	81.8	221.0	18.3	53.0
DULKING STRUCTURE	TBD	222	1	IN LM TUNNEL	111.7	314.7	.0	.0
BAU CAMERA - MATCH BRKT	C6437.	111	1	LM VOLUME CENTROID.	.5	254.0	.0	.0
EQUIP. FROM CM-LM					283.30	270.57	-1.01	14.36

NOTE: Further information relating to this table is given on pages 3.4-19, 3.4-20 and 3.4-21.

Table 3.4-9.2 (Continued)

MISSION H-3 TRANSFERRED CREW AND EQUIPMENT STOWAGE LIST								
ITEMS REARRANGED IN ASC. STAGE PRIOR TO ASC. STAGE JETTISON (19)								
						LM COORDINATES		
DESCRIPTION	STCW. ITEM	REF	NO.	STOWAGE LOCATION	WEIGHT	X-C.G.	Y-C.G.	Z-C.G.
BULKING CREW/GUE	F1000.	112	1	IN LM TUNNEL	21.4	300.0	.0	.0
LM EQUIP.RELOC. 3					21.40	300.00	.00	.00

NOTE: Further information relating to this table is given on pages 3.4-19, 3.4-20 and 3.4-21.

1
 2
 3
 4
 5
 6
 7
 8
 9
 10
 11
 12
 13
 14
 15
 16
 17
 18
 19
 20
 21
 22
 23
 24
 25
 26
 27
 28
 29
 30
 31
 32
 33
 34
 35
 36
 37
 38
 39
 40
 41
 42
 43
 44
 45
 46
 47
 48
 49
 50
 51
 52
 53
 54
 55
 56
 57
 58
 59
 60
 61
 62
 63
 64
 65
 66
 67
 68
 69
 70
 71
 72
 73
 74
 75
 76
 77
 78
 79
 80
 81
 82
 83
 84
 85
 86
 87
 88
 89
 90
 91
 92
 93
 94
 95
 96
 97
 98
 99
 100

Amendment 98
1/22/71

Table 3.4-9.2 (Continued)

MISSION H-3 TRANSFERRED CREW AND EQUIPMENT STORAGE LIST								
ITEMS REARRANGED IN ASC. STAGE PRIOR TO ASC. STAGE JETTISON (20)								
LM COORDINATES								
DESCRIPTION	STOW. ITEM	REF	NO.	STORAGE LOCATION	WEIGHT	R-C.G.	Y-C.G.	Z-C.G.
DOCKING DRAGUE	F1000-	112	1	ON CABN FLOOR/DROGUE	21.4	218.5	-19.6	47.6
LM EQUIP.RELOC.3					21.40	218.50	-19.60	47.60

NOTE: Further information relating to this table is given on pages 3.4-19, 3.4-20 and 3.4-21.

Table 3.4-9.2 (Continued)

MISSION H-3 TRANSFERRED CREW AND EQUIPMENT STOWAGE LIST								
ITEMS REARRANGED IN CM PCST A/S JETTISON (21)								
APOLLO COORDINATES								
DESCRIPTION	STCW. ITEM	REF	NO.	STOWAGE LOCATION	WEIGHT	X-C.G.	Y-C.G.	Z-C.G.
TUUSU+LIME SUIT ASSY, IV-CMP.	B0201.1	127	1	ON CREW-CMP(LH STA)	30.3	1043.0	-24.5	-10.4
HELMET ASSY, PRESSURE-CMP.	B0201.2	127	1	ON CREW-CMP(LH STA)	2.5	1043.0	-24.5	-10.4
GLOVES, IV(PAIR)-CMP.	B0201.3	127	1	ON CREW-CMP(LH STA)	1.7	1043.0	-24.5	-10.4
COMMUNICATIONS CARRIER-CMP.	B0201.4	127	1	ON CREW-CMP(LH STA)	1.6	1043.0	-24.5	-10.4
PCKET, CHECKLIST+SCISSORS-CMP.	B0201.5	167	1	ON PGA (CREW-LH STA)	.2	1043.0	-24.5	-10.4
PCKET, CHECKLIST-CMP	B0201.6	167	1	ON PGA (CREW-LH STA)	.2	1043.0	-24.5	-10.4
BAG, MCTICN SICKNESS-CMP.	A0208.	111	1	ON PGA (CREW-LH STA)	.1	1043.0	-24.5	-10.4
UCLA-CMP.	B0205.	117	1	ON PGA (CREW-LH STA)	.5	1043.0	-24.5	-10.4
T-ADAPTER, CWG-CMP.	B0135.	111	1	IN ADAPTER BAG (AP)	.4	1012.0	22.0	-23.0
JACKET ASSY, ICG-CMP.	B0112.1	111	1	IN CM PGA CONTAINER	1.8	1011.0	.0	-14.0
TROUSER ASSY, ICG-CMP.	B0112.2	111	1	IN CM PGA CONTAINER	1.8	1011.0	.0	-14.0
BOOT, RIGHT, ICG-CMP.	B0112.3	111	1	IN CM PGA CONTAINER	.4	1011.0	.0	-14.0
BOOT, LEFT, ICG-CMP.	B0112.4	111	1	IN CM PGA CONTAINER	.4	1011.0	.0	-14.0
EATUBE, UNIVERSAL-CMP.	E0105.1	111	1	ON ICG (PGA CONTAIN)	NEGL	1011.0	.0	-14.0
HEADSET, LIGHTWEIGHT-CMP.	F0104.	111	1	AREA AB	.4	1012.0	22.0	-23.0
SUBSYSTEM, FECAL CONTAINMENT-CMP	B0113.	117	1	ON CREW-CMP(LH STA)	.3	1043.0	-24.5	-10.4
TUUSU+LIME SUIT ASSY, EV-CDR.	B0200.1	127	1	ON CREW-CDR(CTR. STA)	38.6	1043.0	.0	-10.4
HELMET ASSY, PRESSURE-CDR.	B0200.2	127	1	ON CREW-CDR(CTR. STA)	2.5	1043.0	.0	-10.4
GLOVES, IV(PAIR)-CDR.	B0200.3	127	1	ON CREW-CDR(CTR. STA)	1.6	1043.0	.0	-10.4
COMMUNICATION CARRIER-CDR.	B0200.4	127	1	ON CREW-CDR(CTR. STA)	1.6	1043.0	.0	-10.4
PCKET, CHECKLIST+SCISSORS-CDR.	B0200.5	167	1	ON PGA(CREW-CTR STA)	.2	1043.0	.0	-10.4
PCKET, CHECKLIST-CDR.	B0200.6	167	1	ON PGA(CREW-CTR STA)	.2	1043.0	.0	-10.4
T-ADAPTER, CWG-CDR.	B0135.	111	1	IN ADAPTER BAG (AP)	.4	1012.0	22.0	-23.0
JACKET ASSY, ICG-CDR.	B0112.1	111	1	IN CM PGA CONTAINER	1.8	1011.0	.0	-14.0
TROUSER ASSY, ICG-CDR.	B0112.2	111	1	IN CM PGA CONTAINER	1.8	1011.0	.0	-14.0
BOOT, RIGHT, ICG-CDR.	B0112.3	111	1	IN CM PGA CONTAINER	.4	1011.0	.0	-14.0
BOOT, LEFT, ICG-CDR.	B0112.4	111	1	IN CM PGA CONTAINER	.4	1011.0	.0	-14.0
EATUBE, UNIVERSAL-CDR.	E0105.	111	1	ON ICG (PGA CONTAIN)	NEGL	1011.0	.0	-14.0
HEADSET, LIGHTWEIGHT-CDR.	F0104.	111	1	AREA AB	.4	1012.0	22.0	-23.0
CLOTHING, CONSTANT WEAR-CDR.	B0208.	111	1	IN CM PGA CONTAINER	.8	1011.0	.0	-14.0
CLOTHING, LIQUID COOLING - CDR.	B0107.	111	1	ON CREW-CDR(CTR. STA)	5.0	1043.0	.0	-10.4
TUUSU+LIME SUIT ASSY, EV-LMP.	B0200.1	127	1	ON CREW-LMP(RH STA)	38.6	1043.0	24.5	-10.4

NOTE: Further information relating to this table is given on pages 3.4-19, 3.4-20 and 3.4-21.

Table 3.4-9.2 (Continued)

MISSION H-3 TRANSFERRED CREW AND EQUIPMENT STOWAGE LIST								
ITEMS REARRANGED IN CM PCST A/S JETTISON (21)								
DESCRIPTION	STOW. ITEM	REF	NO.	STOWAGE LOCATION	WEIGHT	APCLL COORDINATES		
						X-C.G.	Y-C.G.	Z-C.G.
HELMET ASSY, PRES SURF-LMP.	BO200.2	127	1	CM CREW-LMP(RH STA)	2.5	1043.0	24.5	-10.4
GLVES, IVIPAIRI-LMP.	BO200.7	127	1	CM CREW-LMP(RH STA)	1.8	1043.0	24.5	-10.4
COMMUNICATIONS CARRIER-LMP.	BO200.4	127	1	CM CREW-LMP(RH STA)	1.6	1043.0	24.5	-10.4
PULKE T, CHECKLIST+SCISSORS-LMP.	BO200.5	167	1	CM PGA (CREW-RH STA)	.2	1043.0	24.5	-10.4
PULKE T, CHECKLIST-LMP.	BO200.6	167	1	CM PGA (CREW-RH STA)	.2	1043.0	24.5	-10.4
T-ADAPTER, CNG-LMP.	BO135.	111	1	IN ADAPTER BAG (AB)	.4	1012.0	22.0	-23.0
JACKET ASSY, ICG-LMP.	BO112.1	111	1	IN CM PGA CONTAINER	1.8	1011.0	.0	-14.0
TROUSER ASSY, ICG-LMP.	BO112.2	111	1	IN CM PGA CONTAINER	1.8	1011.0	.0	-14.0
SHO T, RIGHT, ICG-LMP.	BO112.3	111	1	IN CM PGA CONTAINER	.4	1011.0	.0	-14.0
SHO T, LEFT, ICG-LMP.	BO112.4	111	1	IN CM PGA CONTAINER	.4	1011.0	.0	-14.0
FRUIT JUF, UNIVERSAL-LMP.	FO105.	111	1	CM ICG (PGA CONTAIN)	NEGL	1011.0	.0	-14.0
HEADSET, LIGHTWEIGHT-LMP.	EO104.	111	1	AREA AB	.4	1012.0	22.0	-23.0
SARMENT, CONSTANT HEAR-LMP.	RO208.	111	1	IN CM PGA CONTAINER	.8	1011.0	.0	-14.0
SARMENT, LIQUID COOLING - LMP.	BO107.	111	1	CM CREW-LMP(RH STA)	5.0	1043.0	24.5	-10.4
SUB SYSTEM, FECAL CONTAINMNT-CDR	BO113.	117	1	CM CREW-CDR(CTR. STA)	.3	1043.0	.0	-10.4
SUB SYSTEM, FECAL CONTAINMNT-LMP	BO113.	117	1	CM CREW-LMP(RH STA)	.3	1043.0	24.5	-10.4
BAG, DECON, LUNAR SAMPLE	O6425.	111	1	AREA U1	5.0	1033.0	23.0	-50.0
BAG, DECON, LUNAR SAMPLE	O6426.	111	1	AREA U1	5.0	1033.0	23.0	-50.0
BAG, DECONTAM., CSC CASSETTE	O6328.	111	1	SRC 1 DECON.BAG (AB)	.1	1012.0	22.0	-23.0
BAG, DECONTAM., CONTNR. LUNAR SRC	O6329.	111	1	SRC 1 DECON.BAG (AB)	.1	1012.0	22.0	-23.0
BAG, DECONTAM., LS FASSELBLAD MAG	O6330.	111	1	SRC 1 DECON.BAG (AB)	.2	1012.0	22.0	-23.0
BAG, DECONTAMINATION, SRC NO.2	O6331.	111	1	SRC 1 DECON.BAG (AB)	.9	1012.0	22.0	-23.0
BAG, DECONTAMINATION, SRC NO.1	O6331.1	111	1	AREA AB	4.6	1012.0	22.0	-23.0
BAG, DECONTAMINATION, ISA	O6385.	111	1	AREA AB	4.6	1012.0	22.0	-23.0
BAG, RETURN EQUIPMENT	O6394.	111	1	AREA AB	1.0	1012.0	22.0	-23.0
BAG, DECONTAM., 16MM L.S. MAG.	O6409.	111	1	AREA AB	.3	1012.0	22.0	-23.0
DELTA. EAC, 70MM MAG.	O6431.	111	1	AREA AB	.2	1012.0	22.0	-23.0
CM EQUIP. REFLECT.					173.10	1037.77	4.50	-13.77

NOTE: Further information relating to this table is given on pages 3.4-19, 3.4-20 and 3.4-21.

Table 3.4-9.2 (Continued)

MISSION H-3 TRANSFERRED CREW AND EQUIPMENT STOWAGE LIST								
ITEMS REARRANGED IN CM PCST A/S JETTISON (22)								
APOLLO COORDINATES								
DESCRIPTION	STOW. ITEM	REF	NO.	STOWAGE LOCATION	WFIGHT	X-C.G.	Y-C.G.	Z-C.G.
TUNSU+LIME SUIT ASSY, IV-CMP.	R0201.1	127	1	SLEEP RESTRAINT-RT.	30.3	1020.0	25.0	-22.0
HELMET ASSY, PRESSURE-CMP.	R0201.2	127	1	SLEEP RESTRAINT-RT.	2.5	1020.0	25.0	-22.0
GLJVES, IV (PAIR)-CMP.	B0201.3	127	1	SLEEP RESTRAINT-RT.	1.7	1020.0	25.0	-22.0
COMMUNICATIONS CARRIER-CMP.	B0201.4	127	1	IN ACCES. BAG (HSB/CMP)	1.6	1043.0	-22.0	-55.5
PULKET, CHECKLIST+SCISSORS-CMP.	R0201.5	167	1	CM ICG-CDR./CTR. STA.	.2	1043.0	.0	-10.4
PULKET, CHECKLIST-CMP	E0201.6	167	1	CM ICG-CDR./CTR. STA.	.2	1043.0	.0	-10.4
BAG, MOTION SICKNESS-CMP.	A0208.	111	1	CM PGA (PGA CONT)	.1	1011.0	.0	-14.0
ULTA-CMP.	E0205.	117	1	CM CREW-CMP(LH STA)	.5	1043.0	-24.5	-10.4
T-ADAPTER, CWG-CMP.	H0135.	111	1	CM CREW-CMP(LH STA)	.4	1043.0	-24.5	-10.4
JACKET ASSY, ICG-CMP.	H0112.1	111	1	CM CREW-CMP(LH STA)	1.8	1043.0	-24.5	-10.4
TRUSSE ASSY, ICG-CMP.	R0112.2	111	1	CM CREW-CMP(LH STA)	1.8	1043.0	-24.5	-10.4
BOOT, RIGHT, ICG-CMP.	H0112.3	111	1	CM CREW-CMP(LH STA)	.4	1043.0	-24.5	-10.4
BOOT, LEFT, ICG-CMP.	F0112.4	111	1	CM CREW-CMP(LH STA)	.4	1043.0	-24.5	-10.4
EARTUBE, UNIVERSAL-CMP.	E0105.1	111	1	CM ICG-CMP./LH STA.	NEGL	1043.0	-24.5	-10.4
HEADSET, LIGHTWEIGHT-CMP.	E0104.	111	1	CM CREW-CMP(LH STA)	.4	1043.0	-24.5	-10.4
SUBSYSTEM, FFAL CONTAINMENT-CMP	B0113.	117	1	APEA UI	.3	1033.0	23.0	-50.0
TUNSU+LIME SUIT ASSY, EV-CDR.	B0200.1	127	1	IN CM PGA CONTAINER	38.6	1011.0	.0	-14.0
HELMET ASSY, PRESSURE-CDR.	B0200.2	127	1	IN CDR HSB-LH LEP	2.5	1048.0	-30.0	34.0
GLJVES, IV (PAIR)-CDR.	B0200.3	127	1	IN ACCES. BAG (HSB/CDR)	1.6	1048.0	-30.0	34.0
COMMUNICATION CARRIER-CDR.	R0200.4	127	1	IN ACCES. BAG (HSB/CDR)	1.6	1048.0	-30.0	34.0
PULKET, CHECKLIST+SCISSORS-CDR.	B0200.5	167	1	CM ICG-CDR./CTR. STA.	.2	1043.0	.0	-10.4
PULKET, CHECKLIST-CDR.	H0200.6	167	1	CM ICG-CDR./CTR. STA.	.2	1043.0	.0	-10.4
T-ADAPTER, CWG-CDR.	B0135.	111	1	CM CREW-CDR(CTR. STA)	.4	1043.0	.0	-10.4
JACKET ASSY, ICG-CDR.	H0112.1	111	1	CM CREW-CDR(CTR. STA)	1.8	1043.0	.0	-10.4
TRUSSE ASSY, ICG-CDR.	B0112.2	111	1	CM CREW-CDR(CTR. STA)	1.8	1043.0	.0	-10.4
BOOT, RIGHT, ICG-CDR.	R0112.3	111	1	CM CREW-CDR(CTR. STA)	.4	1043.0	.0	-10.4
BOOT, LEFT, ICG-CDR.	B0112.4	111	1	CM CREW-CDR(CTR. STA)	.4	1043.0	.0	-10.4
EARTUBE, UNIVERSAL-CDR.	F0105.	111	1	CM ICG-CDR./CTR. STA.	NEGL	1043.0	.0	-10.4
HEADSET, LIGHTWEIGHT-CDR.	E0104.	111	1	CM CREW-CDR(CTR. STA)	.4	1043.0	.0	-10.4
GARMENT, CONSTANT WEAR-CDR.	B0208.	111	1	CM CREW-CDR(CTR. STA)	.8	1043.0	.0	-10.4
GARMENT, LIQUID COOLING - CDR.	B0167.	111	1	APEA UI	5.0	1033.0	23.0	-50.0
TUNSU+LIME SUIT ASSY, EV-LMP.	B0200.1	127	1	IN CM PGA CONTAINER	38.6	1011.0	.0	-14.0

NOTE: Further information relating to this table is given on pages 3.4-19, 3.4-20 and 3.4-21.

1/22/71

Table 3.4-9.2 (Continued)

MISSION H-3 TRANSFERRED CREW AND EQUIPMENT STORAGE LIST								
ITEMS REARRANGED IN CM PCST A/S JETTISON (22)								
DESCRIPTION	STCW. ITEM	REF	NU.	STORAGE LOCATION	WEIGHT	APOLLO COORDINATES		
						X-C.G.	Y-C.G.	Z-C.G.
HELMET ASSY, PRESSURE-LMP.	PO200.2	127	1	1A LMP HSB-RH BMD	2.5	1034.0	22.0	-55.0
GLOVES, IV (PAIR)-LMP.	PO200.7	127	1	1N ACCES. BAG (HSB/LMP)	1.8	1034.0	22.0	-55.0
COMMUNICATIONS CARRIER-LMP.	PO200.4	127	1	1N ACCES. BAG (HSB/LMP)	1.6	1034.0	22.0	-55.0
PURKET, CHECKLIST+SCISSORS-LMP.	PO200.5	167	1	1N ICG-LMP./RH STA.	.2	1043.0	24.5	-10.4
PURKET, CHECKLIST-LMP.	PO200.6	167	1	1N ICG-LMP./RH STA.	.2	1043.0	24.5	-10.4
T-ADAPTER, CWG-LMP.	BO135.	111	1	0N CREW-LMP (RH STA)	.4	1043.0	24.5	-10.4
JACKET ASSY, ICG-LMP.	BO112.1	111	1	0N CREW-LMP (RH STA)	1.8	1043.0	24.5	-10.4
TRUSER ASSY, ICG-LMP.	BO112.2	111	1	0N CREW-LMP (RH STA)	1.8	1043.0	24.5	-10.4
SHIRT, RIGHT, ICG-LMP.	BO112.3	111	1	0N CREW-LMP (RH STA)	.4	1043.0	24.5	-10.4
SHIRT, LEFT, ICG-LMP.	BO112.4	111	1	0N CREW-LMP (RH STA)	.4	1043.0	24.5	-10.4
EAK TUBE, UNIVERSAL-LMP.	EO105.	111	1	1A ICG-LMP./RH STA.	NEGL	1043.0	24.5	-10.4
HEADSET, LIGHTWEIGHT-LMP.	EO104.	111	1	1N CREW-LMP (RH STA)	.4	1043.0	24.5	-10.4
CLOTHING, CONSTANT WEAR-LMP.	RO208.	111	1	1A CREW-LMP (RH STA)	.8	1043.0	24.5	-10.4
CLOTHING, LIQUID COOLING - LMP.	HO1C7.	111	1	ARFA U1	5.0	1033.0	23.0	-50.0
SUBSYSTEM, FECAL CONTAINMENT-CDM	PO113.	117	1	ARFA U1	.3	1033.0	23.0	-50.0
SUBSYSTEM, FECAL CONTAINMENT-LMP	BO113.	117	1	ARFA U1	.3	1033.0	23.0	-50.0
BAG, DECCA, LUNAR SAMPLE	06425.	111	1	AREA A13	5.0	1010.0	-22.0	-2.0
BAG, DECCA, LUNAR SAMPLE	06426.	111	1	1A CONTAINER A10	5.0	1011.0	23.0	6.0
BAG, DECONTAM., CSC CASSETTE	06328.	111	1	BAG, RETURN EQUIP (B1)	.1	1050.0	-27.0	39.0
BAG, DECONTAM., CONTR. LUNAR SRC	06329.	111	1	BAG, RETURN EQUIP (B1)	.1	1050.0	-27.0	39.0
BAG, DECONTAM., LS PASSELBLAD MAG.	06330.	111	1	ARFA R13	.2	1024.0	45.0	-26.0
BAG, DECONTAMINATION, SRC NO. 2	06331.	111	1	ARFA B6	.9	1031.0	13.0	39.0
BAG, DECONTAMINATION, SRC NO. 1	06331.1	111	1	ARFA B5	.9	1031.0	-8.0	39.0
BAG, DECONTAMINATION, ISA	06385.	111	1	ARFA A1	4.6	1012.0	-22.0	-26.0
BAG, RETURN EQUIPMENT	06394.	111	1	ARFA B1	1.0	1050.0	-27.0	39.0
BAG, DECONTAM., 16MP L.S. MAG.	06409.	111	1	ARFA R13	.3	1024.0	45.0	-26.0
JELLY. BAG, 7044 MAG.	06431.	111	1	ARFA P13	.2	1024.0	45.0	-26.0
CM EQUIP. RELIC. 3					173.10	1020.50	5.55	-16.19

NOTE: Further information relating to this table is given on pages 3.4-19, 3.4-20 and 3.4-21.

Table 3.4-9.2 (Continued)

MISSION H-3 TRANSFERRED CREW AND EQUIPMENT STOWAGE LIST								
ITEMS REARRANGED IN CM PRIOR TO ENTRY (??)								
APOLLO COORDINATES								
DESCRIPTION	STOW. ITEM	REF	N ^o .	STOWAGE LOCATION	WEIGHT	X-C.G.	Y-C.G.	Z-C.G.
COMMUNICATIONS CARRIER-CMP.	B0201.4	127	1	IA ACCES.BAG(HSB)/CMP	1.6	1043.0	-22.0	-55.5
HEADSET, LIGHTWEIGHT-CMP.	E0104.	111	1	CA CREW-CMP(LH STA)	.4	1043.0	-24.5	-10.4
GLOVES, IV(PAIR)-CDR.	B0200.3	127	1	IA ACCES.BAG(HSB)/CDR	1.6	1048.0	-30.0	34.0
COMMUNICATION CARRIER-CDR.	B0200.4	127	1	IA ACCES.BAG(HSB)/CDR	1.6	1048.0	-30.0	34.0
HEADSET, LIGHTWEIGHT-CMP.	E0104.	111	1	CA CREW-CDR(CTR. STA)	.4	1043.0	.0	-10.4
GLOVES, IV(PAIR)-LMP.	B0200.7	127	1	IA ACCES.BAG(HSB)/LMP	1.8	1034.0	22.0	-55.0
COMMUNICATIONS CARRIER-LMP.	B0200.4	127	1	IA ACCES.BAG(HSB)/LMP	1.6	1034.0	22.0	-55.0
HEADSET, LIGHTWEIGHT-LMP.	F0104.	111	1	CA CREW-LMP(RH STA)	.4	1043.0	24.5	-10.4
BAG, HELMET STOW, INFLIGHT-CMP.	B0105.	115	1	LM BHD-HSB/CMP	.6	1043.0	-22.0	-55.0
BAG, HELMET STOW, INFLIGHT-CDR.	B0105.	115	1	LM LEB-HSB/CDP	.6	1048.0	-30.0	34.0
BAG, HELMET STOW, INFLIGHT-LMP.	B0105.	115	1	LM BH -HSB/LMP	.6	1034.0	22.0	-55.0
BAG, ACCESSORY-CMP.	B0105.1	115	1	IA CMP HSB-LH BHD	.3	1043.0	-22.0	-55.0
BAG, ACCESSORY-CDR.	B0105.1	115	1	IA CDR HSB-LH LEB	.3	1048.0	-30.0	34.0
BAG, ACCESSORY-LMP.	B0105.1	115	1	IA LMP HSB-RH RHD	.3	1034.0	22.0	-55.0
CONTAINER, TEMP. STOW-CMP.	C0301.	115	1	HP LEB-TSB	1.7	1039.5	33.5	34.0
CONTAINER, TEMP. STOW-CDR.	C0301.	115	1	LP GIRTH RING/TSB	1.7	1028.0	-45.0	-28.0
CONTAINER, TEMP. STOW-LMP.	C0301.	115	1	HP GIRTH RING-TSB	1.7	1030.0	36.0	-43.0
CONTAINER, #12	C0344	115	1	CONT. R12(RH GRTH. RAG)	2.7	1034.0	41.0	-21.0
CSM LAUNCH CHECKLIST	A0114.1	164	2	FCF(R12/PH GRTH. RAG)	1.0	1034.0	41.0	-21.0
CSM W/C CHECKLIST	A0114.2	164	1	FCF(R12/RH GRTH. RAG)	1.0	1034.0	41.0	-21.0
CSM SYSTEM CHECKLIST	A0114.3	164	1	FCF(R12/RH GRTH. RAG)	1.0	1034.0	41.0	-21.0
CSM LUNAR LANDMARK MAP	A0114.5	164	1	FCF(R12/RH GRTH. RAG)	.6	1034.0	41.0	-21.0
CSM JATA SYSTEMS	A0114.7	164	1	FCF(R12/RH GRTH. RAG)	.9	1034.0	41.0	-21.0
CSM MALFUNCTIONS PROCEDURES	A0114.8	164	1	FCF(R12/RH GRTH. RAG)	.6	1034.0	41.0	-21.0
FLIGHT PLAN	A0114.9	164	1	FCF(R12/RH GRTH. RAG)	3.0	1034.0	41.0	-21.0
CMP SUDO PORK	A0114.11	164	1	FCF(R12/PH GRTH. RAG)	.9	1034.0	41.0	-21.0
RESCUE BUCK	A0114.15	164	1	FCF(R12/RH GRTH. RAG)	.9	1034.0	41.0	-21.0
SLEEP RESTRAINT ASSY-LH	C3022.	117	1	UNDEP LH COUCH	3.7	1018.0	-24.5	-15.0
PAL, HEADREST-CDR.	B0130.	117	1	AREA A5	1.1	1015.0	9.0	28.0
HEEL RESTRAINT(PH)-CDP.	B0132.	117	1	AREA A5	1.2	1015.0	9.0	28.0

NOTE: Further information relating to this table is given on pages 3.4-19, 3.4-20 and 3.4-21.

Table 3.4-9.2 (Continued)

MISSION H-3 TRANSFERRED CREW AND EQUIPMENT STOWAGE LIST								
ITEMS REARRANGED IN CM PRIOR TO ENTRY (23)								
DESCRIPTION	STCW. ITEM	REF.	NO.	STOWAGE LOCATION	WEIGHT	APOLLO COORDINATES		
						X-C.G.	Y-C.G.	Z-C.G.
PAW, HEADREST-LMP.	B0130.	117	1	AREA A5	1.1	1015.0	9.0	28.0
HEEL RESTRAINT(PR)-LMP	B0132.	117	1	AREA A5	1.2	1015.0	9.0	28.0
PAW, HEADREST-CMP.	B0130.	117	1	AREA A5	1.1	1015.0	9.0	28.0
HEEL RESTRAINT(PR)-CMP.	B0132.	117	1	AREA A5	1.2	1015.0	9.0	28.0
FILTER, CABIN FAN	G6395.	111	1	FILTER BAG(PGA CONT)	2.4	1015.0	.0	-19.9
STOW.BAG, CABIN FAN FILTER	G6410.	111	1	IN CM PGA CONTAINER	1.6	1011.0	.0	-14.0
CM EQUIP.RELIC.4					44.40	1029.73	10.05	-11.44

NOTE: Further information relating to this table is given on pages 3.4-19, 3.4-20 and 3.4-21.

Table 3.4-9.2 (Continued)

MISSION H-3 TRANSFERRED CREW AND EQUIPMENT STOWAGE LIST								
ITEMS REARRANGED IN CM PRICK TO ENTRY (24)								
APLLOC COORDINATES								
DESCRIPTION	STW. ITEM	REF	NO.	STOWAGE LOCATION	WEIGHT	X-C.G.	Y-C.G.	Z-C.G.
COMMUNICATIONS CARRIER-CMP.	P0201.4	127	1	CA CREW-CMP(LH STA)	1.6	1043.0	-24.5	-10.4
HEADSET, LIGHTWEIGHT-CMP.	E0104.	111	1	AREA AB	.4	1012.0	22.0	-23.0
GLOVES, IV (PAIR)-CDR.	P0200.3	127	1	ACCES. BAG (HSR/R6)	1.6	1046.0	46.0	29.0
COMMUNICATIONS CARRIER-CDR.	P0200.4	127	1	CA CREW-CDR(CTR. STA)	1.6	1043.0	.0	-10.4
HEADSET, LIGHTWEIGHT-CDR.	E0104.	111	1	AREA AB	.4	1012.0	22.0	-23.0
GLOVES, IV (PAIR)-LMP.	P0200.7	127	1	ACCES. BAG (HSR/L3)	1.8	1048.0	-47.0	12.0
COMMUNICATIONS CARRIER-LMP.	P0200.4	127	1	CA CREW-LMP(RH STA)	1.6	1043.0	24.5	-10.4
HEADSET, LIGHTWEIGHT-LMP.	E0104.	111	1	AREA AB	.4	1012.0	22.0	-23.0
BAG, HELMET STOW, INFLIGHT-CMP.	B0105.	115	1	AREA R1	.6	1050.0	-27.0	39.0
BAG, HELMET STOW, INFLIGHT-CDR.	F0105.	115	1	AREA R6	.6	1048.0	46.0	29.0
BAG, HELMET STOW, INFLIGHT-LMP.	F0105.	115	1	AREA L3	.6	1048.0	-47.0	12.0
BAG, ACCESSORY-CMP.	F0105.1	115	1	HELMET STOW BAG (R1)	.3	1050.0	-27.0	39.0
BAG, ACCESSORY-CDR.	F0105.1	115	1	HELMET STOW BAG (R6)	.3	1046.0	46.0	29.0
BAG, ACCESSORY-LMP.	F0105.1	115	1	HELMET STOW BAG (L3)	.3	1046.0	-47.0	12.0
CONTAINER, TEMP. STOW-CMP.	C0301.	115	1	AREA A1	1.7	1012.0	-22.0	-26.0
CONTAINER, TEMP. STOW-CDR.	C0301.	115	1	AREA A1	1.7	1012.0	-22.0	-26.0
CONTAINER, TEMP. STOW-LMP.	C0301.	115	1	AREA A1	1.7	1012.0	-22.0	-26.0
CONTAINER, FIZ	C0344	115	1	AREA R3	2.7	1072.0	26.0	9.0
CSM LAUNCH CHECKLIST	A0114.1	164	2	IN FDF (R12/IN R3)	1.0	1072.0	26.0	9.0
CSM G/C CHECKLIST	A0114.2	164	1	IN FDF (R12/IN R3)	1.0	1072.0	26.0	9.0
CSM SYSTEM CHECKLIST	A0114.3	164	1	IN FDF (R12/IN R3)	1.0	1072.0	26.0	9.0
CSM LUNAR LANDMARK MAP	A0114.5	164	1	IN FDF (R12/IN R3)	.6	1072.0	26.0	9.0
CSM DATA SYSTEMS	A0114.7	164	1	IN FDF (R12/IN R3)	.9	1072.0	26.0	9.0
CSM 4ALFUNCTIONS PROCEDURES	A0114.8	164	1	IN FDF (R12/IN R3)	.6	1072.0	26.0	9.0
FLIGHT PLAN	A0114.9	164	1	IN FDF (R12/IN R3)	3.0	1072.0	26.0	9.0
CMP SULO BOOK	A0114.11	164	1	IN FDF (R12/IN R3)	.9	1072.0	26.0	9.0
RESCUE BOOK	A0114.15	164	1	IN FDF (R12/IN R3)	.9	1072.0	26.0	9.0
SLEEP RESTRAINT ASSY-LH	C3022.	117	1	AFT UPR EQUIP. BAY-LH	3.7	1018.0	-21.9	-49.9
PAW, HEADREST-CDR.	F0130.	117	1	CA CREW(CTR. CRW. STA)	1.1	1043.0	.0	-10.4
HEEL RESTRAINT(PR)-CDR.	B0132.	117	1	CA CREW-CDR(CTR. STA)	1.2	1043.0	.0	-10.4

NOTE: Further information relating to this table is given on pages 3.4-19, 3.4-20 and 3.4-21.

Table 3.4-9.2 (Continued)

MISSION M-3 TRANSFERRED CREW AND EQUIPMENT STORAGE LIST								
ITEMS REARRANGED IN CM PRIOR TO ENTRY (24)								
APOLLO COORDINATES								
DESCRIPTION	STOW. ITEM	REF	NO.	STORAGE LOCATION	WEIGHT	X-C.G.	Y-C.G.	Z-C.G.
PAU, HEADREST-LMP.	80130.	117	1	CM COUCH(RH CREW STA	1.1	1043.0	24.5	-10.4
HEEL RESTRAINT(PRI)-LMP	80132.	117	1	CM CREW-LMP(RH STA)	1.2	1043.0	24.5	-10.4
PAU, HEADREST-CMP.	80130.	117	1	CM COUCH(LH CREW STA	1.1	1043.0	-24.5	-10.4
HEEL RESTRAINT(PRI)-CMP.	80132.	117	1	CM CREW-CMP(LH STA)	1.2	1043.0	-24.5	-10.4
FILTER, CABIN FAN	06395.	111	1	AREA AB	2.4	1012.0	22.0	-23.0
STOW. BAG, CABIN FAN FILTER	06410.	111	1	AREA AB	1.6	1012.0	22.0	-23.0
CM EQUIP. RELI'C.4					44.40	1042.68	4.79	-6.87

NOTE: Further information relating to this table is given on pages 3.4-19, 3.4-20 and 3.4-21.

Table 3.4-9.2 (Continued)

LM-B EMERGENCY LIFTOFF TRANSFERABLE EQUIPMENT LIST								
ITEMS REARRANGED IN ASCENT STAGE PRE EVA 1 FOR EMERGENCY LIFTOFF								
DESCRIPTION	STCW. ITEM	REF	NO.	STOWAGE LOCATION	WEIGHT	X-C.G.	Y-C.G.	Z-C.G.
REMOTE CONTROL UNIT- PLSS	B1001.		1	CA MINUS 227 BMD-FCU	5.1	272.0	.0	-18.0
REMOTE CONTROL UNIT- PLSS	B1001.		1	CA MINUS 227 BMD-FCU	5.1	272.0	.0	-18.0
BAG, JETTISON STOWAGE	B1027		1	LM SIDE STOW COMPT.	.9	235.0	-38.0	42.0
J2 PURGE SYS STOWAGE BRACKETS	O3004.		1	CM OPS(SPC RACK NO.1	2.4	257.4	-20.7	-6.0
J2 PURGE SYS STOWAGE BRACKETS	O3004.		1	CM OPS(SPC RACK NO.2	2.4	265.9	-20.7	-6.0
AKM NESTS - LDR	TBD		1	RH CREW STA/INSTALL.	1.1	251.4	6.5	52.0
AKM NESTS - LMP	TBD		1	LM CREW STA/INSTALL.	1.1	251.4	-6.5	51.0
AKM NESTS - L4P	TBD		1	LM CREW STA/INSTALL.	1.1	251.4	-6.5	51.0
BAG, 16MM CAMERA- STOWAGE	O3062.		1	LM SIDE STOW COMPT.	1.0	235.0	-38.0	42.0
BUDY SLSS ASSY	B1052.		1	CM PLUS 227 BMD	10.9	221.0	-1.0	29.5
PLSS/EVC ASSY- LMP	B1025.		1	ON CABIN FLOOR-PLSS	23.0	219.7	.0	44.7
CAMERA L.S. FLECT. HASSELBLAD	A1015.		1	RH SIDE STOW COMPT.	3.1	238.4	38.6	43.0
BAG, 70MM L.S. HASSELBLAD	A0108. 1		1	RH SIDE STOW COMPT.	1.4	238.4	38.6	43.0
INTERIM STOWAGE ASSY.	O3007.		1	ISA(OV.RECHAR.STAT)	7.6	270.3	-15.0	19.0
OXYGEN PURGE SYSTEM	B1012. 2		1	SRC RACK NO.1-LWR.	35.7	257.4	-20.7	-6.0
OXYGEN PURGE SYSTEM	B1012. 2		1	SRC RACK NO.2-UPR.	35.7	265.9	-20.7	-6.0
LENS, 60 MM L.S.F.H.	A1016.		1	RH SIDE STOW COMPT.	1.8	238.4	38.6	43.0
TRIGGER, L.S.F.H.	A1027.		1	RH SIDE STOW COMPT.	.2	238.4	38.6	43.0
HANDLE, L.S.E.H.	A1024.		1	RH SIDE STOW COMPT.	.5	238.4	38.6	43.0
BRACKET, CAMERA MOUNT	B1001. 1		1	ISA(OV.RECHAR.STAT)	.6	270.3	-15.0	19.0
BRACKET, CAMERA MOUNT	B1001. 1		1	ISA(OV.RECHAR.STAT)	.6	270.3	-15.0	19.0
CONTAINER, BUDY SLSS	O3059.		1	CM PLUS 227 BMD	3.1	221.0	-1.0	29.5
KIT, ECU MAINTENANCE	B1016.		1	MSB/LH(ON CABIN FLR)	.5	221.0	-18.3	53.0
PURGE VALVE ASSY	F1017.		1	UPP. BOCT BOX	.5	280.8	-20.0	-9.5
PURGE VALVE ASSY	B1017.		1	LWR. BOCT BOX	.5	273.8	-20.0	-9.5
4mm IV SYSTEM	F1000.		1	CA MINUS 227 BMD-TV	7.6	288.5	.0	-22.6
ELECTRICAL ASSY(ASA SHIRT-PLG)	O3019		1	ISA(OV.RECHAR.STAT)	.1	270.3	-15.0	19.0
PURSE	TBD		1	ISA(OV.RECHAR.STAT)	.0	270.3	-15.0	19.0
PHL EV0 1 PFANG.					214.50	243.43	-7.35	18.95

NOTE: Further information relating to this table is given on pages 3.4-19, 3.4-20 and 3.4-21.

Table 3.4-9.2 (Continued)

LM-8 EMERGENCY LIFTOFF TRANSFERABLE EQUIPMENT LIST								
ITEMS REARRANGED IN ASCENT STAGE PRE EVA 1 FOR EMERGENCY LIFTOFF								
DESCRIPTION	STCW. ITEM	REF	NO.	STORAGE LOCATION	WEIGHT	X-C.G.	Y-C.G.	Z-C.G.
REMOTE CONTROL UNIT- PLSS	B1001.		1	ISA(OVER AS ENG CVR)	5.1	280.0	.0	-10.0
REMOTE CONTROL UNIT- PLSS	B1001.		1	ISA(OVER AS ENG CVR)	5.1	280.0	.0	-10.0
BAG, JETTISON STORAGE	B1027		1	ISA(OVER AS ENG CVR)	.9	280.0	.0	-10.0
J2 PURGE SYS STORAGE BRACKETS	C3004.		1	ISA(OVER AS ENG CVR)	2.4	280.0	.0	-10.0
J2 PURGE SYS STORAGE BRACKETS	C3004.		1	ISA(OVER AS ENG CVR)	2.4	280.0	.0	-10.0
ARM NESTS - CDR	T8C		1	ISA(OVER AS ENG CVR)	1.1	280.0	.0	-10.0
ARM NESTS - LMP	T8D		1	ISA(OVER AS ENG CVR)	1.1	280.0	.0	-10.0
ARM NESTS - LAP	T8D		1	ISA(OVER AS ENG CVR)	1.1	280.0	.0	-10.0
BAG, 16MM CAMERA- STORAGE	O30e2.		1	ISA(OVER AS ENG CVR)	1.0	280.0	.0	-10.0
BAGGY SLSS ASSY	B1052.		1	ISA(OVER AS ENG CVR)	10.9	280.0	.0	-10.0
PLSS/EVC ASSY- LMP	B1025.		1	PLSS DOWNING STATION	83.0	252.4	-5.0	19.2
CAMERA L.S. ELECT. HASSELBLAD	A1015.		1	ISA(OVER AS ENG CVR)	3.1	280.0	.0	-10.0
BAG, 70MM L.S. HASSELBLAD	A0109. 1		1	ISA(OVER AS ENG CVR)	1.4	280.0	.0	-10.0
TRIP EQUIP STORAGE ASSY.	C3007.		1	ISA(OVER AS ENG CVR)	7.6	280.0	.0	-10.0
JAV GEN PURGE SYSTEM	B1012. 2		1	CN CABIN FLOOR-OPS	35.7	219.7	.0	51.4
JAV GEN PURGE SYSTEM	B1012. 2		1	CN CABIN FLOOR-OPS	35.7	219.7	.0	51.4
LLNS, 80 MM L.S.F.H.	A1016.		1	ISA(OVER AS ENG CVR)	1.8	280.0	.0	-10.0
TRIGGER, L.S.F.H.	A1027.		1	ISA(OVER AS ENG CVR)	.2	280.0	.0	-10.0
HANDLE, L.S.F.H.	A1028.		1	ISA(OVER AS ENG CVR)	.5	280.0	.0	-10.0
BRACKET, CAMERA MOUNT	B1001. 1		1	ISA(OVER AS ENG CVR)	.6	280.0	.0	-10.0
BRACKET, CAMERA MOUNT	B1001. 1		1	ISA(OVER AS ENG CVR)	.6	280.0	.0	-10.0
CONTAINER, BIDDY SLSS	C3059.		1	ISA(OVER AS ENG CVR)	3.1	280.0	.0	-10.0
KIT, LMU MAINTENANCE	B1016.		1	ISA(OVER AS ENG CVR)	.5	280.0	.0	-10.0
PURGE VALVE ASSY	B1017.		1	ISA(OVER AS ENG CVR)	.5	280.0	.0	-10.0
PURGE VALVE ASSY	B1017.		1	ISA(OVER AS ENG CVR)	.5	280.0	.0	-10.0
300 TV SYSTEM	E1000.		1	ISA(OVER AS ENG CVR)	7.6	280.0	.0	-10.0
ELECTRICAL ASSY(TASA SHORT PLG)	(3019		1	ISA(OVER AS ENG CVR)	.1	280.0	.0	-10.0
PURSE	TRD		1	ISA(OVER AS ENG CVR)	.9	280.0	.0	-10.0
PKL EVA 1 FRANG.					214.50	249.25	-1.93	21.74

NOTE: Further information relating to this table is given on pages 3.4-19, 3.4-20 and 3.4-21.

Table 3.4-9.2 (Continued)

LM-E EMERGENCY LIFTOFF TRANSFERABLE EQUIPMENT LIST								
ITEMS OFFLOADED AT LUNAR SITE DURING EVA 1								
LM COORDINATES								
DESCRIPTION	STCW. ITEM	REF	NO.	STCWAGE LOCATION	WEIGHT	X-C.G.	Y-C.G.	Z-C.G.
CONVEYOR ASSY, LUNAR EG. (ELEC)	B1C20. 2		1	LH SIDE STCW COMPT.	1.3	235.0	-38.0	42.0
BAU, JETTISON STOWAGE	B1027		1	LH SIDE STCW COMPT.	.9	235.0	-38.0	42.0
JK PURGE SYS STOWAGE BRACKETS	C3004.		1	CN OPS(SPC RACK NO.1	2.4	257.4	-20.7	-6.0
JK PURGE SYS STOWAGE BRACKETS	C3004.		1	CN OPS(SPC RACK NO.2	2.4	265.9	-20.7	-6.0
ARM RESTS - COR	TAD		1	RH CREW STA/INSTALL.	1.1	251.4	6.5	52.0
ARM RESTS - LMP	TAD		1	LH CREW STA/INSTALL.	1.1	251.4	-6.5	51.0
ARM RESTS - LMP	TAD		1	LH CREW STA/INSTALL.	1.1	251.4	-6.5	51.0
BAU, 16MM CAMERA- STOWAGE	C3C62.		1	LH SIDE STCW COMPT.	1.0	235.0	-38.0	42.0
LM LUNAR SURFACE MAPS	A1008. 5		1	FLIGHT DATA FILE CTR	1.7	280.8	-20.0	14.0
CAMERA L.S. EJECT. HASSELEBLAD	A1015.		1	RH SIDE STCW COMPT.	3.1	238.4	38.6	43.0
CAMERA L.S. EJECT. HASSELEBLAD	A1015.		1	RH SIDE STCW COMPT.	3.1	238.4	38.6	43.0
BAU, 70MM L.S. HASSELEBLAD	A0108. 1		2	RH SIDE STCW COMPT.	2.8	236.4	38.6	43.0
MAGAZINE, 16MM DATA ACQUISITION	A0101. 1		1	ISA(OV.RECHAR.STAT)	1.0	270.3	-15.0	19.0
CAMERA, 16MM DATA ACQUISITION	A1043.		1	LH SIDE STCW COMPT.	8.9	235.0	-38.0	42.0
MAGAZINE, 16MM DATA ACQUISITION	A0101. 1		2	RH SIDE STCW COMPT.	2.0	238.4	38.6	43.0
SAMPLES, THERMO COAT. DEGRAD.	F1002.		2	ISA(OV.RECHAR.STAT)	.8	270.3	-15.0	19.0
GLSRU (WITHOUT SAMPLE)	C4C16.		1	LH SIDE STCW COMPT.	.6	235.0	-38.0	42.0
LENS,60 MM L.S.E.H.	A1016.		1	RH SIDE STCW COMPT.	1.8	238.4	38.6	43.0
LENS,60 MM L.S.F.H.	A1016.		1	RH SIDE STCW COMPT.	1.8	238.4	38.6	43.0
TRIGGER, L.S.F.H.	A1027.		1	RH SIDE STCW COMPT.	.2	238.4	38.6	43.0
TRIGGER, L.S.E.H.	A1027.		1	RH SIDE STCW COMPT.	.2	238.4	38.6	43.0
HANDLE, L.S.F.H.	A1029.		1	RH SIDE STCW COMPT.	.5	238.4	38.6	43.0
HANDLE, L.S.E.H.	A1029.		1	RH SIDE STCW COMPT.	.5	238.4	38.6	43.0
BRACKET, CAMERA MOUNT	P1001. 1		1	ISA(OV.RECHAR.STAT)	.6	270.3	-15.0	19.0
BRACKET, CAMERA MOUNT	B1001. 1		1	ISA(OV.RECHAR.STAT)	.6	270.3	-15.0	19.0
BRACKET	P1020. 1		1	LH SIDE STCW COMPT.	.2	235.0	-38.0	42.0
CONTAINER, EMPTY SLESS	C3C59.		1	CN PLUS 227 BMD	3.1	221.0	-1.0	29.5
ADAPTER, BRACKET, RT. ANGLE	A1021.		1	LH SIDE STCW COMPT.	.2	235.0	-38.0	42.0
GAUGE, REMOTE CONTROL	A1C22.		1	LH SIDE STCW COMPT.	.7	235.0	-38.0	42.0
300 TV SYSTEM	E1000.		1	CN MINUS 227 BMD-TV	7.6	288.5	.0	-22.6
BAU, CAMERA MOUNT BRKT	C3034.		1	ISA(OV.RECHAR.STAT)	.3	270.3	-15.0	19.0
BAU, DEPLOY. LFC	B1C20. 3		1	LH SIDE STCW COMPT.	.1	235.0	-38.0	42.0
EVA 1 OFFLOAD:					52.70	249.75	-1.93	26.42

NOTE: Further information relating to this table is given on pages 3.4-19, 3.4-20 and 3.4-21.

Table 3.4-9.2 (Continued)

LM-8 EMERGENCY LIFTOFF TRANSFERABLE EQUIPMENT LIST								
ITEMS UNLOADED INTO ASC. STAGE DURING EVA 1								
LM COORDINATES								
DESCRIPTION	STOW. ITEM	REF	NO.	STORAGE LOCATION	WEIGHT	X-C.G.	Y-C.G.	Z-C.G.
GRT./CAN. PLSS LICH (REPLACEMENT	B1003.		2	FLIGHT DATA FILE CTW	13.4	280.8	-20.0	14.0
BAG LUNAR EQUIPMENT TRANSFER	C3018.		1	R.H. CAB. FLOOR, FWD	.9	221.0	18.0	51.0
LM LUNAR SURFACE MAPS	A10CB.	5	1	ETB (RH FLOOR, FWD)	1.7	221.0	18.0	51.0
CAMERA L.S. ELECT. HASSELBLAD	A1015.		1	ETB (RH FLOOR, FWD)	3.1	221.0	18.0	51.0
CAMERA L.S. ELECT. HASSELBLAD	A1015.		1	ETB (RH FLOOR, FWD)	3.1	221.0	18.0	51.0
MAG. 70MM L.S. HASSELBLAD	A0108.	1	2	ETB (RH FLOOR, FWD)	2.8	221.0	18.0	51.0
MAGAZINE, 16MM DATA ACQUISITION	A0101.	1	1	ETB (RH FLOOR, FWD)	1.0	221.0	18.0	51.0
MAGAZINE, 16MM DATA ACQUISITION	A0101.	1	2	ETB (RH FLOOR, FWD)	2.0	221.0	18.0	51.0
CONTNR. SAMPL. RET. NO. 1 (LOD)	C4003.		1	SHC RACK NO. 1-LWR.	65.0	257.4	-20.7	-6.0
WEIGH BAG WITH SMALL PICKS	G4018.		1	ISA (OVER AS ENG CVR)	15.0	280.0	.0	-10.0
WEIGH BAG WITH FOOTBALL SIZ. PK	G4018.		1	LHSSC (SAMPLE)	30.0	235.5	-32.6	42.4
CLSKL (WITH SAMPLE)	G4016.		1	ISA (OVER AS ENG CVR)	2.6	280.0	.0	-10.0
LENS/SCRIPE/HRUSH	T80		1	ISA (OVER AS ENG CVR)	.3	280.0	.0	-10.0
LENS, 60 MM L.S.E.H.	A1016.		1	ETB (RH FLOOR, FWD)	1.8	221.0	18.0	51.0
LENS, 60 MM L.S.E.H.	A1016.		1	ETB (RH FLOOR, FWD)	1.8	221.0	18.0	51.0
TRIGGER, L.S.E.H.	A1027.		1	ETB (RH FLOOR, FWD)	.2	221.0	18.0	51.0
TRIGGER, L.S.E.H.	A1027.		1	ETB (RH FLOOR, FWD)	.2	221.0	18.0	51.0
HANDLE, L.S.E.H.	A1028.		1	ETB (RH FLOOR, FWD)	.5	221.0	18.0	51.0
HANDLE, L.S.E.H.	A1028.		1	ETB (RH FLOOR, FWD)	.5	221.0	18.0	51.0
BRACKET, CAMERA MOUNT	R1001.	1	1	ETB (RH FLOOR, FWD)	.6	221.0	18.0	51.0
BRACKET, CAMERA MOUNT	R1001.	1	1	ETB (RH FLOOR, FWD)	.6	221.0	18.0	51.0
EVA 1 CNLCAD					147.10	252.67	-15.07	13.27

NOTE: Further information relating to this table is given on pages 3.4-19, 3.4-20 and 3.4-21.

Table 3.4-9.2 (Continued)

LM-8 EMERGENCY LIFTOFF TRANSFERABLE EQUIPMENT LIST								
ITEMS REARRANGED IN ASCENT STAGE PRE EVA 2 FOR EMERGENCY LIFTOFF								
DESCRIPTION	STCW. ITEM	REF	NO.	STOWAGE LOCATION	WEIGHT	X-C.G.	Y-C.G.	Z-C.G.
REMOTE CONTROL UNIT- PLSS	B1001.		1	CN MINUS 227 BMD-RCU	5.1	272.0	.0	-18.0
REMOTE CONTROL UNIT- PLSS	B1001.		1	CN MINUS 227 BMD-RCU	5.1	272.0	.0	-18.0
CRT./CAN, PLSS LICH REPLACEMENT	R1003.		2	FLIGHT DATA FILE CTR	13.4	280.8	-20.0	14.0
BAG, PLSS FEEDWATER COLLECTION	F1026.		1	LH SIDE STOW COMPT.	.8	235.0	-38.0	42.0
BAG, PLSS FEEDWTR. COL. W/O SCALE	B1026.		1	LH SIDE STOW COMPT.	.5	235.0	-38.0	42.0
URINE BAGS	C3009.		2	RH SIDE STOW COMPT.	.6	238.4	38.6	43.0
BAG, LUNAR EQUIPMENT TRANSFER	C3018.		1	R.H. CAB. FLOOP, FWD	.9	221.0	18.0	51.0
HAMMOCK-COR	C3048.		1	LH SIDE STOW COMPT.	4.1	235.0	-38.0	42.0
HAMMOCK-LMP	C3050.		1	LH SIDE STOW COMPT.	3.9	235.0	-38.0	42.0
BATTERY, PLSS	F1004.		1	LH SIDE STOW COMPT.	5.5	235.0	-38.0	42.0
BATTERY, PLSS	R1004.		1	LH SIDE STOW COMPT.	5.5	235.0	-38.0	42.0
BULB/ PLSS ASSY	R1052.		1	CN PLUS 227 BMD	10.9	221.0	-1.0	29.5
PLSS/EVC ASSY- LMP	R1025.		1	ON CABIN FLOOR-PLSS	83.0	219.7	.0	44.7
CAMERA L.S. ELECT. HASSELBLAD	A1015.		1	ETB (RH FLOOR, FWD)	3.1	221.0	18.0	51.0
CAMERA L.S. ELECT. HASSELBLAD	A1015.		1	ETB (RH FLOOR, FWD)	3.1	221.0	18.0	51.0
MAG, 70MM L.S. HASSELBLAD	A0108. 1		2	ETB (RH FLOOR, FWD)	2.8	221.0	18.0	51.0
MAG, 70MM L.S. HASSELBLAD	A0108. 1		1	RH SIDE STOW COMPT.	1.4	238.4	38.6	43.0
MAGAZINE, 16MM DATA ACQUISITION	A0101. 1		1	ETB (RH FLOOR, FWD)	1.0	221.0	18.0	51.0
MAGAZINE, 16MM DATA ACQUISITION	A0101. 1		2	ETB (RH FLOOR, FWD)	2.0	221.0	18.0	51.0
DISPOSAL CONTAINER	C3012.		1	LH SIDE STOW COMPT.	1.8	235.0	-38.0	42.0
INTERIM STOWAGE ASSY.	C3007.		1	ISA(OV. RECHAR. STAT)	7.6	270.3	-15.0	19.0
POLARIZING FILTER	A1005.		1	RH SIDE STOW COMPT.	.2	238.4	38.6	43.0
LM ELS CARTIDGE +BRACKET	C3008.		1	CANNISTER (PEAR. AEC)	9.2	250.0	8.8	-11.8
OXYGEN PURGE SYSTEM	B1012. 2		1	SRC RACK NO.1-LWR.	35.7	257.4	-20.7	-6.0
OXYGEN PURGE SYSTEM	H1012. 2		1	SRC RACK NO.2-UPR.	35.7	265.9	-20.7	-6.0
LENS, 60 MM L.S.E.H.	A1016.		1	ETB (RH FLOOR, FWD)	1.8	221.0	18.0	51.0
LENS, 60 MM L.S.E.H.	A1016.		1	ETB (RH FLOOR, FWD)	1.8	221.0	18.0	51.0
TRIGGER, L.S.E.H.	A1027.		1	ETB (RH FLOOR, FWD)	.2	221.0	18.0	51.0
TRIGGER, L.S.E.H.	A1027.		1	ETB (RH FLOOR, FWD)	.2	221.0	18.0	51.0
HANDLE, L.S.E.H.	A1028.		1	ETB (RH FLOOR, FWD)	.5	221.0	18.0	51.0
HANDLE, L.S.E.H.	A1028.		1	ETB (RH FLOOR, FWD)	.5	221.0	18.0	51.0
BRACKET, CAMERA MOUNT	R1001. 1		1	ETB (RH FLOOR, FWD)	.6	221.0	18.0	51.0

NOTE: Further information relating to this table is given on pages 3.4-19, 3.4-20 and 3.4-21.

Table 3.4-9.2 (Continued)

LM-R EMERGENCY LIFTOFF TRANSFERABLE EQUIPMENT LIST								
ITEMS REARRANGED IN ASCENT STAGE PRE EVA 2 FOR EMERGENCY LIFTOFF								
DESCRIPTION	STCW. ITEM	REF	NO.	STORAGE LOCATION	WEIGHT	X-C.G.	Y-C.G.	Z-C.G.
BRACKET, CAMERA MOUNT	P1001. 1		1	ETA (RH FLOOR, FWD)	.6	221.0	18.0	51.0
KIT, EMU MAINTENANCE	E1016.		1	LSH/LHION CABIN FLR)	.5	221.0	-18.3	53.0
PURGE VALVE ASSY	P1017.		1	LPR. BOOT BOX	.5	280.8	-20.0	-9.5
PURGE VALVE ASSY	E1017.		1	LWR. FOOT BOX	.5	273.8	-20.0	-9.5
SAMPLE SCALE	G4031.			LH SIDE STCW COMPT.	.5	235.0	-38.0	42.0
ELECTRICAL ASSY(ASA SHORT.PLG)	E3019		1	ISA(OV.RECHAR.STAT)	.1	270.3	-15.0	19.0
PUMSE	TBD		1	ISA(OV.RECHAR.STAT)	.9	270.3	-15.0	19.0
PRE EVA 2 REANG.					252.10	241.70	-8.98	22.60

NOTE: Further information relating to this table is given on pages 3.4-19, 3.4-20 and 3.4-21.

Table 3.4-9.2 (Continued)

LM-B EMERGENCY LIFTOFF TRANSFERABLE EQUIPMENT LIST								
ITEMS REARRANGED IN ASCENT STAGE PRE EVA 2 FOR EMERGENCY LIFTOFF								
DESCRIPTION	STCW. ITEM	REF	NO.	STORAGE LOCATION	WEIGHT	X-C.G.	Y-C.G.	Z-C.G.
REMOTE CONTROL UNIT- PLSS	R1001.		1	UPP. BOOT RCK	5.1	280.0	-20.0	-9.5
REMOTE CONTROL UNIT- PLSS	R1001.		1	LOW. BOOT RCK	5.1	273.6	-20.0	-9.5
CONT./CAN. PLSS LICH REPLACEMENT	R1003.		2	ISA(OVER AS ENG CVR)	13.4	280.0	.0	-10.0
BAG, PLSS FEEDWTR COLLECTION	R1026.		1	ISA(OVER AS ENG CVR)	.8	280.0	.0	-10.0
BAG, PLSS FEEDWTR. COL. VVO SCALE	R1026.		1	ISA(OVER AS ENG CVR)	.5	280.0	.0	-10.0
URINE BAGS	C3009.		2	ISA(OVER AS ENG CVR)	.6	280.0	.0	-10.0
BAG, LUNAR EQUIPMENT TRANSFER	C3018.		1	CAB FLOOR, FORWARD	.9	221.7	.0	29.0
HAMMOCK-CEP	C3048.		1	ISA(OVER AS ENG CVR)	4.1	280.0	.0	-10.0
HAMMOCK-LMP	C3050.		1	ISA(OVER AS ENG CVR)	3.9	280.0	.0	-10.0
BATTERY, PLSS	R1004.		1	ISA(OVER AS ENG CVR)	5.5	280.0	.0	-10.0
BATTERY, PLSS	R1004.		1	ISA(OVER AS ENG CVR)	5.5	280.0	.0	-10.0
JUDY SLSS ASSY	B1052.		1	CAB FLOOR, FORWARD	10.9	221.7	.0	29.0
PLSS/EVC ASSY- LMP	B1025.		1	PLSS DONNING STATION	83.0	252.4	-5.0	19.2
CAMERA L.S. ELECT. HASSELBLAD	A1015.		1	CAB FLOOR, FORWARD	3.1	221.7	.0	29.0
CAMERA L.S. ELECT. HASSELBLAD	A1015.		1	CAB FLOOR, FORWARD	3.1	221.7	.0	29.0
MAG. 70MM L.S. HASSELBLAD	A0109. 1		2	CAB FLOOR, FORWARD	2.8	221.7	.0	29.0
MAG. 70MM L.S. HASSELBLAD	A0109. 1		1	CAB FLOOR, FORWARD	1.4	221.7	.0	29.0
MAGAZINE, 16MM DATA ACQUISITION	A0101. 1		1	CAB FLOOR, FORWARD	1.0	221.7	.0	29.0
MAGAZINE, 16MM DATA ACQUISITION	A0101. 1		2	CAB FLOOR, FORWARD	2.0	221.7	.0	29.0
DISPOSAL CONTAINER	D3012.		1	ISA(OVER AS ENG CVR)	1.8	280.0	.0	-10.0
INTEGR. STORAGE ASSY.	C3007.		1	ISA(OVER AS ENG CVR)	7.6	280.0	.0	-10.0
POLARIZING FILTER	A1005.		1	CAB FLOOR, FORWARD	.2	221.7	.0	29.0
LM ECS CANTHIDGE BRACKET	C3008.		1	ISA(OVER AS ENG CVR)	9.2	280.0	.0	-10.0
OXYGEN PURGE SYSTEM	B1012. 2		1	CN CABIN FLOOR-OPS	35.7	219.7	.0	51.4
OXYGEN PURGE SYSTEM	B1012. 2		1	CN CABIN FLOOR-OPS	35.7	219.7	.0	51.4
LENS, 60 MM L.S.F.H.	A1016.		1	CAB FLOOR, FORWARD	1.8	221.7	.0	29.0
LENS, 60 MM L.S.F.H.	A1016.		1	CAB FLOOR, FORWARD	1.8	221.7	.0	29.0
TRIGGER, L.S.F.H.	A1027.		1	CAB FLOOR, FORWARD	.2	221.7	.0	29.0
TRIGGER, L.S.F.H.	A1027.		1	CAB FLOOR, FORWARD	.2	221.7	.0	29.0
HANDLE, L.S.F.H.	A1028.		1	CAB FLOOR, FORWARD	.5	221.7	.0	29.0
HANDLE, L.S.F.H.	A1028.		1	CAB FLOOR, FORWARD	.5	221.7	.0	29.0
BRACKET, CAMERA MOUNT	R1001. 1		1	CAB FLOOR, FORWARD	.6	221.7	.0	29.0

NOTE: Further information relating to this table is given on pages 3.4-19, 3.4-20 and 3.4-21.

Table 3.4-9.2 (Continued)

LM-8 EMERGENCY LIFTOFF TRANSFERABLE EQUIPMENT LIST								
ITEMS REARRANGED IN ASCENT STAGE PRE EVA 2 FOR EMERGENCY LIFTOFF								
DESCRIPTION	STGW. ITEM	REF	NO.	STOWAGE LOCATION	WEIGHT	X-C.G.	Y-C.G.	Z-C.G.
BASKET, CAMERA MOUNT	B10C1.	1	1	CAB FLOOR, FORWARD	.6	221.7	.0	29.0
KIT, SCRU MAINTENANCE	H1016.		1	ISA(OVER AS ENG CVR)	.5	280.0	.0	-10.0
PURGE VALVE ASSY	R1017.		1	ISA(OVER AS ENG CVR)	.5	280.0	.0	-10.0
PURGE VALVE ASSY	R1C17.		1	ISA(OVER AS ENG CVR)	.5	280.0	.0	-10.0
SAMPLE SCALE	G4031.			ISA(VER AS ENG CVR)	.5	280.0	.0	-10.0
ELECTRICAL ASSY(ASA SHORT.PLG)	C3C19		1	ISA(VER AS ENG CVR)	.1	280.0	.0	-10.0
PURSE	TBD		1	ISA(VER AS ENG CVR)	.9	280.0	.0	-10.0
PRE EVA 2 REARRANG.					252.10	246.42	-2.46	21.91

NOTE: Further information relating to this table is given on pages 3.4-19, 3.4-20 and 3.4-21.

Table 3.4-9.2 (Continued)

LM-8 EMERGENCY LIFTOFF TRANSFERABLE EQUIPMENT LIST								
ITEMS OFFLOADED AT LUNAR SITE LUNAR EVA 2								
						LM COORDINATES		
DESCRIPTION	STCW. ITEM	REF	NO.	STCWAGE LOCATION	WEIGHT	X-C.G.	Y-C.G.	Z-C.G.
CHI./CAN, PLSS LICH (REPLACEMENT)	E1003.		2	FLIGHT DATA FILE CTR	12.4	280.8	-20.0	14.0
BAG, PLSS FEEDWATER COLLECTION	B1026.		1	LF SIDE STCW COMPT.	.8	235.0	-38.0	42.0
BAG, PLSS FEEDWTR. COL. W/O SCALE	B1026.		1	LF SIDE STCW COMPT.	.5	235.0	-38.0	42.0
URINE BAGS	G3009.		2	RF SIDE STCW COMPT.	.6	238.4	38.6	43.0
BAG, LUNAR EQUIPMENT TRANSFER	C3018.		1	R.H. CAN. FLOOR, FWD	.5	221.0	18.0	51.0
HAMMOCK-COR	C3048.		1	LM SIDE STCW COMPT.	4.1	235.0	-38.0	42.0
HAMMOCK-LMP	C3050.		1	LF SIDE STCW COMPT.	3.9	235.0	-38.0	42.0
BATTERY, PLSS	B1004.		1	LM SIDE STCW COMPT.	5.5	235.0	-38.0	42.0
BATTERY, PLSS	B1004.		1	LF SIDE STCW COMPT.	5.5	235.0	-38.0	42.0
QUDDY SLSS ASSY	B1052.		1	LM PLUS 227 BHD	10.9	221.0	-1.0	29.5
LM LUNAR SURFACE MAPS	A1008.	5	1	ETB (RM FLOOR, FWD)	1.7	221.0	18.0	51.0
LM FLCC WASTE	C1000		1	FOOD CONTAINER NO.1	2.3	279.8	-20.0	.0
LM FOJD WASTE	C1000.		1	FOOD CONTAINER NO.2	3.0	273.8	-20.0	.0
CAMERA L.S. FLECT. HASSELBLAD	A1015.		1	ETB (RM FLOOR, FWD)	3.1	221.0	18.0	51.0
CAMERA L.S. FLECT. HASSELBLAD	A1015.		1	ETB (RM FLOOR, FWD)	3.1	221.0	18.0	51.0
MAG, 70MM L.S. HASSELBLAD	A0108.	1	2	ETB (RM FLOOR, FWD)	2.8	221.0	18.0	51.0
MAG, 70MM L.S. HASSELBLAD	A0108.	1	1	RF SIDE STCW COMPT.	1.4	238.4	38.6	43.0
MAGAZINE, 16MM DATA ACQUISITION	A0101.	1	1	ETB (RM FLOOR, FWD)	1.0	221.0	18.0	51.0
MAGAZINE, 16MM DATA ACQUISITION	A0101.	1	2	ETB (RM FLOOR, FWD)	2.0	221.0	18.0	51.0
DISPOSAL CONTAINER	G3012.		1	LM SIDE STCW COMPT.	1.8	235.0	-38.0	42.0
LENS/SCREE/PRUSH	TRO		1	ISA (OVER AS ENG CVR)	.3	280.0	.0	-10.0
POLARIZING FILTER	A1005.		1	RF SIDE STCW COMPT.	.2	238.4	38.6	43.0
LM ELS CARTRIDGE +BRACKET	C3009.		1	CANNISTER (REAR, AEG)	9.2	250.0	8.8	-11.8
LENS, 60 MM L.S.E.H.	A1016.		1	ETB (RM FLOOR, FWD)	1.8	221.0	18.0	51.0
LENS, 60 MM L.S.E.H.	A1016.		1	ETB (RM FLOOR, FWD)	1.8	221.0	18.0	51.0
TRIGGER, L.S.E.H.	A1027.		1	ETB (RM FLOOR, FWD)	.2	221.0	18.0	51.0
TRIGGER, L.S.E.H.	A1027.		1	ETB (RM FLOOR, FWD)	.2	221.0	18.0	51.0
HANDLE, L.S.E.H.	A1028.		1	ETB (RM FLOOR, FWD)	.5	221.0	18.0	51.0
HANDLE, L.S.E.H.	A1028.		1	ETB (RM FLOOR, FWD)	.5	221.0	18.0	51.0

NOTE: Further information relating to this table is given on pages 3.4-19, 3.4-20 and 3.4-21.

Amendment 98
1/22/71

Table 3.4-9.2 (Continued)

LM-8 EMERGENCY LIFTOFF TRANSFERABLE EQUIPMENT LIST								
ITEMS OFFLOADED AT LUNAR SITE DURING EVA 2								
DESCRIPTION	STCW. ITEM	REF	QTY.	STOWAGE LOCATION	WEIGHT	LM COORDINATES		
						X-C.G.	Y-C.G.	Z-C.G.
BRACKET, CAMERA MOUNT	B1001. 1		1	ETR (RM FLOOR, FWD)	.6	221.0	18.0	51.0
BRACKET, CAMERA MOUNT	B1001. 1		1	ETR (RM FLOOR, FWD)	.6	221.0	18.0	51.0
ELC LICH STRAP	G3C24.		1	AFT OF ASC. ENG. COVER	.1	245.8	8.8	-15.0
TW ELS, LM UTILITY (RED)	B1043.		2	LM SIDE STOW COMPT.	.2	235.0	-38.0	42.0
TW ELS, LM UTILITY (BLUF)	B1044.		2	LM SIDE STOW COMPT.	.2	235.0	-38.0	42.0
EVA 2 OFFLOAD					84.70	241.49	-8.25	29.47

NOTE: Further information relating to this table is given on pages 3.4-19, 3.4-20 and 3.4-21.

Table 3.4-9.2 (Continued)

LM-6 EMERGENCY LIFTOFF TRANSFERABLE EQUIPMENT LIST								
ITEMS UNLOADED INTO ASCENT STAGE DURING EVA2								
LM COORDINATES								
DESCRIPTION	STCW, ITFM	REF	QTY	STORAGE LOCATION	WEIGHT	X-C.G.	Y-C.G.	Z-C.G.
BAG, LUNAR EQUIPMENT TRANSFER	C3018.		1	ISA(OVER AS ENG CVR)	.9	280.0	.0	-10.0
LM LUNAR SURFACE MAPS	A1008. 5		1	FLIGHT DATA FILE CTR	1.7	280.8	-20.0	14.0
CAMERA L.S. ELFCT. HASSELBLAD	A1015.		1	RH SIDE STOW COMPT.	3.1	238.4	38.6	43.0
MAG, 70MM L.S. HASSELBLAD	A0108. 1		2	RF SIDE STOW COMPT.	2.8	238.4	38.6	43.0
MAG, 70MM L.S. HASSELBLAD	A0109. 1		1	ISA(OVER AS ENG CVR)	1.4	280.0	.0	-10.0
MAGAZINE, 16MM DATA ACQUISITION	A0101. 1		1	RF SIDE STOW COMPT.	1.0	238.4	38.6	43.0
MAGAZINE, 16MM DATA ACQUISITION	A0101. 1		2	RF SIDE STOW COMPT.	2.0	238.4	38.6	43.0
SAMPLE CONTAINER, MAGNETIC SHD	G4039.		1	ISA(OVER AS ENG CVR)	1.0	280.0	.0	-10.0
CASSETTE, CLOSE-UP CAMERA(CSC)	J1001.		1	ISA(OVER AS ENG CVR)	.5	280.0	.0	-10.0
CONTIN. SAMP. PFT. NO.2 (LUD)	G4004.		1	SPC RACK NO.2-UPR.	65.0	265.9	-20.7	-6.0
SOLAR WIND COMPOSITION EXPR.	G4C11.		1	ISA(OVER AS ENG CVR)	.3	280.0	.0	-10.0
SAMPLES, THERMO COAT. DEGRAD.	F1002.		2	ISA(OVER AS ENG CVR)	.8	280.0	.0	-10.0
WIGH BAG WITH FOOTBALL SIZ. RK	G4018.		1	ISA(OVER AS ENG CVR)	30.0	280.0	.0	-10.0
LENS, 60 MM L.S.E.H.	A1016.		1	RF SIDE STOW COMPT.	1.8	238.4	38.6	43.0
TRIGGER, L.S.F.H.	A1027.		1	ISA(OVER AS ENG CVR)	.2	280.0	.0	-10.0
HANDLE, L.S.E.H.	A1028.		1	ISA(OVER AS ENG CVR)	.5	280.0	.0	-10.0
BRACKET, CAMERA MOUNT	R1001. 1		1	ISA(OVER AS ENG CVR)	.6	280.0	.0	-10.0
SESSICLNT. SAMPLES)	G4040.		1	ISA(OVER AS ENG CVR)	1.0	280.0	.0	-10.0
MAG, SAMP. RETURN	C3060.			PLUS Z27 MHD-ROCKS	35.0	221.2	2.2	29.5
EVA 2 ENLCAU					145.60	257.15	-5.95	5.04

NOTE: Further information relating to this table is given on pages 3.4-19, 3.4-20 and 3.4-21.

Table 3.4-9.2 (Continued)

LM-8 EMERGENCY LIFTOFF TRANSFERABLE EQUIPMENT LIST								
ITEMS REARRANGED IN ASCENT STAGE PRE DEPRFS. FOR EMERGENCY LIFTOFF								
DESCRIPTION	STCW. ITEM	REF	NO.	STOWAGE LOCATION	WEIGHT	X-C.G.	Y-C.G.	Z-C.G.
REMOTE CONTROL UNIT- PLSS	F1001.		1	CA MINUS 227 BMD-RCU	5.1	272.0	.0	-18.0
REMOTE CONTROL UNIT- PLSS	H1001.		1	CA MINUS 227 BMD-RCU	5.1	272.0	.0	-18.0
ARM RESTS - CDR	TBD		1	RM CREW STA/INSTALL.	1.1	251.4	6.5	52.0
JUMBO BAG	C3009.		1	RM SIDE STCW COMPT.	.3	238.4	38.6	43.0
CONTAINER, PLSS CONDENSATE	C3014.		1	LM MID-SECTION	4.4	257.6	-18.0	-18.0
BOOTS, LUNAR (PR.)-CDR	F1018.		1	UPP. BOOT BOX	4.5	280.8	-20.0	-9.5
BOOTS, LUNAR (PR.)	H1018		1	LWR. BOOT BOX	4.5	273.8	-20.0	-9.5
TELEPH, EVA RETRACTABLE-CDR	A1029		1	CA CDR PLSS(RECHG ST	.2	262.8	-20.8	15.4
TELEPH, EVA RETRACTABLE-LMP	A1029		1	CA LMP PLSS(ICBN.FLR)	.2	219.7	.0	44.7
PLSS/EVC ASSY- LMP	R1025.		1	ON CABIN FLCCP-PLSS	23.0	219.7	.0	44.7
CAMERA L.S. ELECT. HASSELBLAD	A1015.		1	PH SIDE STCW COMPT.	3.1	238.4	38.6	43.0
MAGAZINE, 16MM DATA ACQUISITION	A0101. 1		1	RM SIDE STCW COMPT.	1.0	238.4	38.6	43.0
MAGAZINE, 16MM DATA ACQUISITION	A0101. 1		2	RM SIDE STCW COMPT.	2.0	238.4	38.6	43.0
DISPOSAL CONTAINER	C3012.		1	LM SIDE STCW COMPT.	1.8	235.0	-38.0	42.0
INTERIM STOWAGE ASSY.	C3007.		1	ISA(OV.RECHAR.STAT)	7.6	270.3	-15.0	19.0
OXYGEN PURGE SYSTEM	H1012. 2		1	SRC RACK NO.1-LWR.	35.7	257.4	-20.7	-6.0
OXYGEN PURGE SYSTEM	H1012. 2		1	SRC RACK NO.2-UPR.	35.7	265.9	-20.7	-6.0
KIT,EMU MAINTENANCE	F1016.		1	HSB/LM(ON CABIN FLR)	.5	221.0	-18.3	53.0
PURGE VALVE ASSY	H1017.		1	UPR.ROCT BOX	.5	280.8	-20.0	-9.5
PURGE VALVE ASSY	H1017.		1	LWR.ROCT BOX	.5	273.8	-20.0	-9.5
SAMPLE SCALE	G4031.		1	LM SIDE STCW COMPT.	.5	235.0	-38.0	42.0
ELECTRICAL ASSY(ASA SHIRT.PLG)	C3019		1	ISA(OV.RECHAR.STAT)	.1	270.3	-15.0	19.0
PURSE	TBC		1	ISA(OV.RECHAR.STAT)	.9	270.3	-15.0	19.0
PKL JEPRES.PFANG					198.30	244.44	-8.74	17.93

NOTE: Further information relating to this table is given on pages 3.4-19, 3.4-20 and 3.4-21.

Table 3.4-9.2 (Continued)

LM-6 EMERGENCY LIFTOFF TRANSFERABLE EQUIPMENT LIST								
ITEMS REARRANGED IN ASCENT STAGE PRE DEPRES. FOR EMERGENCY LIFTOFF								
DESCRIPTION	STCW. ITEM	REF	NO.	STOWAGE LOCATION	WEIGHT	X-C.G.	Y-C.G.	Z-C.G.
REMOTE CONTROL UNIT- PLSS	B1001.		1	CAB FLOOR, FORWARD	5.1	221.7	.0	29.0
REMOTE CONTROL UNIT- PLSS	B1001.		1	CAB FLOOR, FORWARD	5.1	221.7	.0	29.0
ARM RESTS - CDP	TRD		1	CAB FLOOR, FORWARD	1.1	221.7	.0	29.0
MAIL BAG	C3009.		1	CAB FLOOR, FORWARD	.3	221.7	.0	29.0
CONTAINER, PLSS CONDENSATE	C3014.		1	CAB FLOOR, FORWARD	4.4	221.7	.0	29.0
SOOTS, LUNAR (PR.)-CDR	B1019.		1	CAB FLOOR, FORWARD	4.5	221.7	.0	29.0
SOOTS, LUNAR (PR.)	B1019		1	CAB FLOOR, FORWARD	4.5	221.7	.0	29.0
TETHER, EVA RETRACTABLE-CDR	A1029		1	CAB FLOOR, FORWARD	.2	221.7	.0	29.0
TETHER, EVA RETRACTABLE-LMP	A1029		1	CAB FLOOR, FORWARD	.2	221.7	.0	29.0
PLSS/EVC ASSY- LMP	P1025.		1	PLSS DONNING STATION	P3.0	252.4	-5.0	19.2
CAMERA L.S. ELFCT. HASSELRAD	A1015.		1	ISA(OVER AS ENG CVR)	3.1	280.0	.0	-10.0
MAGAZINE, 16MM DATA ACQUISITION	A0101. 1		1	ISA(OVER AS ENG CVR)	1.0	280.0	.0	-10.0
MAGAZINE, 16MM DATA ACQUISITION	A0101. 1		2	ISA(OVER AS ENG CVR)	2.0	280.0	.0	-10.0
DISPOSAL CONTAINER	C3012.		1	CAB FLOOR, FORWARD	1.8	221.7	.0	29.0
INTERIP STORAGE ASSY.	C3007.		1	ISA(OVER AS ENG CVR)	7.6	280.0	.0	-10.0
JAYGEN PURGE SYSTEM	P1012. 2		1	LN CABIN FLOOR-OPS	35.7	219.7	.0	51.4
JAYGEN PURGE SYSTEM	P1012. 2		1	CN CABIN FLOOR-OPS	35.7	219.7	.0	51.4
KIT,EMU MAINTENANCE	E1016.		1	ISA(OVER AS ENG CVR)	.5	280.0	.0	-10.0
PURGE VALVE ASSY	P1017.		1	ISA(OVER AS ENG CVR)	.5	280.0	.0	-10.0
PURGE VALVE ASSY	P1017.		1	ISA(OVER AS ENG CVR)	.5	280.0	.0	-10.0
SAMPLE SCALE	G4031.		1	ISA(OVER AS ENG CVR)	.5	280.0	.0	-10.0
ELECTRICAL ASSY(ASA SHORT-PLG)	C3019		1	ISA(OVER AS ENG CVR)	.1	280.0	.0	-10.0
PURSE	TRD		1	ISA(OVER AS ENG CVR)	.9	280.0	.0	-10.0
PRE DEPRES. REARRANG					198.30	238.74	-2.09	29.68

NOTE: Further information relating to this table is given on pages 3.4-19, 3.4-20 and 3.4-21.

TABLE 3.4-10 (CONTINUED)

Command Module Water and GOX

	Pressure (PSIA)	Loading Requirement Weight (lb)	Earth Launch Weight (lb)	Actual (lb)
Waste Water ⁶			18.0	33.0
Potable Water ⁷			36.0	31.4
CM/GOX	900±50	3.7	6.7 (Entry)	

⁸Service Module Hydrogen and Oxygen

	Loading Requirement (pounds)	Earth Launch Weight (pounds)	Actual (lb)
Hydrogen			
Tank 1	29.3	27.6	27.2
Tank 2	29.3	27.6	27.2
Oxygen			
Tank 1	330.1	316.6	316.9
Tank 2	330.1	316.6	316.9
Tank 3	330.1	198.1	204.7

NOTES:

- ¹Indicated propellant load is based on nominal pressure and temperature prior to actual loading. This number will be updated after loading is accomplished.
- ²See Section 4.1 for explanation of trapped SPS propellant.
- ³See Table 3.4-13 for loading uncertainties.
- ⁴See Section 4.2 for SM/RCS loads and uncertainties to be used in Mission Planning. Actual SM/RCS loads and uncertainties will be published in Table 3.4-15.
- ⁵See Section 4.2 for CM/RCS loads and uncertainties to be used in Mission Planning. Actual CM/RCS loads and uncertainties will be published in Table 3.4-14.
- ⁶Launch Rule Redlines determine lift-off values.
- ⁷Launch Rule Redlines determine lift-off values.
- ⁸Launch Mission Rules will determine minimum lift-off quantities for H₂ and O₂.
- ⁹CSM helium and nitrogen should be loaded in accordance with loading windows contained in CSM/LM Spacecraft Operational Data Book, Volume I, Part 2, SNA-8-D-027(1) P2.



TABLE 3.4-11

SPS PROPELLANT LOAD CALCULATIONS

	<u>Fuel</u>	<u>Oxidizer</u>
1. Enter SPS Quantity Readout at 110 PSIA (Table 3.4-12 Item C - Percent)	<u>100.8</u>	<u>100.85</u>
2. Use Figures 4.1-3 and 4.1-4 to obtain propellant load for above quantity readout.	<u>15688.0</u>	<u>25079.5</u>
3. Nominal propellant density at loading temperature (use temperature - density graph below) (lb/ft ³)	<u>56.428</u>	<u>90.346</u>
4. Cubic feet of propellant (Item 2 divided by Item 3)	<u>278.017</u>	<u>276.485</u>
5. Calculated density from Table 3.4-12 Item F (lb/ft ³)	<u>56.454</u>	<u>90.279</u>
6. Adjustment due to PUGS zero adjust (pounds)	<u>-</u>	<u>-</u>
7. Resulting actual propellant load (Item 4 times Item 5, less Item 6) (pounds)	<u>15695.2</u>	<u>25061.0</u>

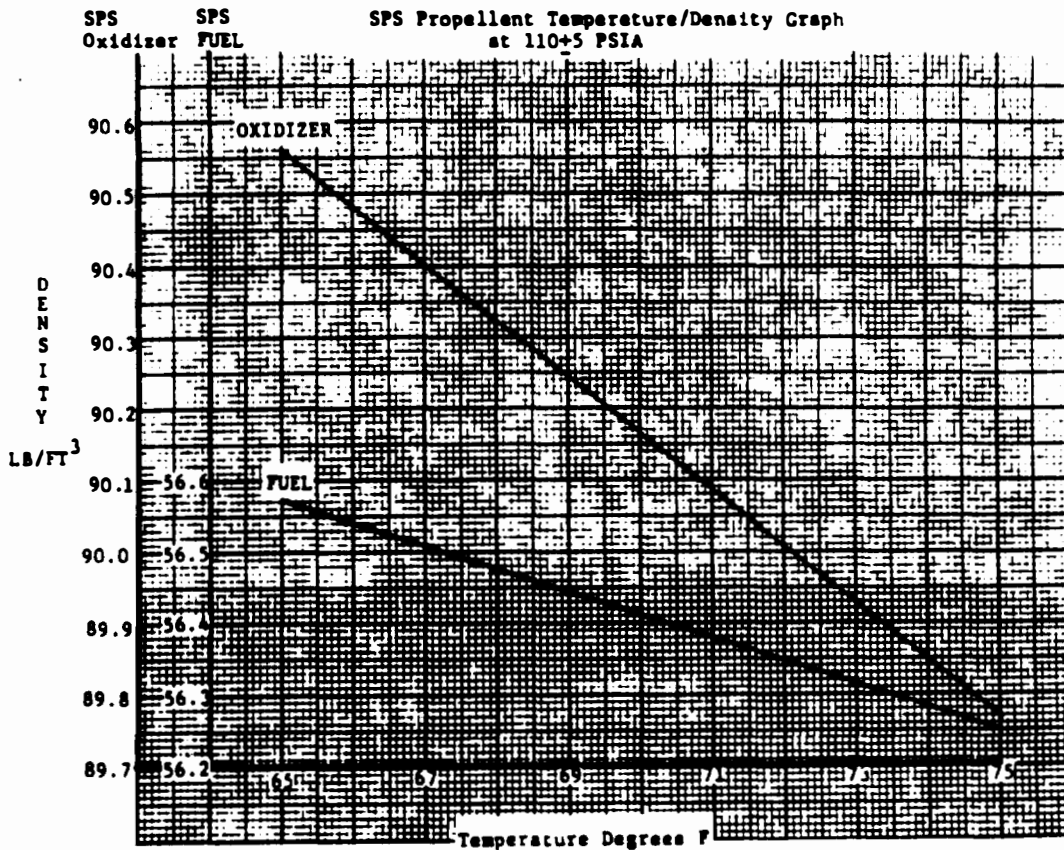

U U E E E E L E E E E E H H E E L L

TABLE 3.4-12

Mission H-3 SPS Propellant Load Parameters
(To be provided by KSC following loading)

Enter the following information at zero adjust - time			
<u>Fuel</u>		<u>Oxidizer</u>	
Adjusted quantity fuel readout - Percent	<u>0.0</u>	Adjusted quantity oxidizer readout - Percent	<u>0.0</u>
Fuel storage voltage reading taken from ACE to three significant digits - volts	<u>0.0</u>	Oxidizer storage voltage reading taken from ACE to three significant digits - volts	<u>0.0</u>
Fuel sump voltage reading taken from ACE to three significant digits - volts	<u>0.0</u>	Oxidizer sump voltage reading taken from ACE to three significant digits - volts	<u>0.0</u>

Enter the following information at Sump Tank Full Adjust
(Propellant at top of standpipe)

<u>Fuel</u>		<u>Oxidizer</u>	
Fuel sump tank pressure - PSIA	<u>29.0</u>	Oxidizer sump tank pressure - PSIA	<u>29.0</u>
Fuel temperature - °F	<u>69.4</u>	Oxidizer temperature - °F	<u>67.4</u>
Adjusted quantity fuel readout - Percent	<u>55.17</u>	Adjusted quantity oxidizer readout - %	<u>55.2</u>
Fuel sump voltage reading taken from ACE to three significant digits - volts	<u>4.58</u>	Oxidizer sump voltage reading taken from ACE to three significant digits - volts	<u>4.60</u>

Enter the following information at Storage Tank Full Adjust
(Propellant at Point Sensor #1)

<u>Fuel</u>		<u>Oxidizer</u>	
Fuel storage tank pressure - PSIA	<u>109.0</u>	Oxidizer storage tank pressure - PSIA	<u>111.0</u>
Fuel temperature - °F	<u>69.5</u>	Oxidizer temperature - °F	<u>67.7</u>
Adjusted quantity fuel readout - %	<u>96.05</u>	Adjusted quantity oxidizer readout - %	<u>96.0</u>
Fuel storage voltage reading taken from ACE to three significant digits - volts	<u>4.07</u>	Oxidizer storage voltage reading taken from ACE to three significant digits - volts	<u>4.03</u>
Fuel sump voltage reading taken from ACE to three significant digits - volts	<u>4.625</u>	Oxidizer sump voltage reading taken from ACE to three significant digits - volts	<u>4.625</u>

TABLE 3.4-12 (Continued)

Amendment 98
1/22/71

Enter the following information when tanking is complete (110±5 PSIA) Time			
<u>Fuel</u>		<u>Oxidizer</u>	
a. System pressure - PSIA	<u>110.0</u>	a. System pressure - PSIA	<u>111.0</u>
b. Fuel temperature - °F	<u>69.5</u>	b. Oxidizer temperature - °F	<u>67.7</u>
c. Quantity fuel readout - %	<u>100.8</u>	c. Quantity oxidizer readout - %	<u>100.85</u>
d. Fuel measured specific gravity @ 25°C - 14.7 PSIA	<u>0.8998</u>	d. Oxidizer measured specific gravity @ 4°C - 14.7 PSIA	<u>1.4812</u>
e. Fuel measured density 25°C - 14.7 PSIA (Item d times 62.428) - lb/ft ³	<u>56.172</u>	e. Oxidizer measured density @ 4°C - 14.7 PSIA (Item d times 62.428) - lb/ft ³	<u>92.468</u>
f. Calculated density - lb/ft ³ - at system pressure and temperature Items a and b above. Use density equation outlined in Section 4.1.	<u>56.454</u>	f. Calculated density - lb/ft ³ - at system pressure and temperature, Item a and b above. Use density equation outlined in Section 4.1.	<u>90.279</u>
g. Fuel storage voltage reading from ACE	<u>4.55</u>	g. Oxidizer storage voltage reading from ACE	<u>4.53</u>
h. Fuel sump voltage reading from ACE	<u>4.625</u>	h. Oxidizer sump voltage reading from ACE	<u>4.625</u>

Enter the following information at leak check pressure			
<u>Fuel</u>		<u>Oxidizer</u>	
System pressure - PSIA	<u>190.0</u>	System pressure - PSIA	<u>191.0</u>
Quantity fuel readout - %	<u>100.35</u>	Quantity oxidizer readout - %	<u>100.55</u>
Fuel storage voltage reading from ACE	<u>4.41</u>	Oxidizer storage voltage readout from ACE	<u>4.35</u>
Fuel sump voltage reading from ACE	<u>4.70</u>	Oxidizer sump voltage readout from ACE	<u>4.74</u>

TABLE 3.4-14

Command Module RCS Loading Parameters and Calculations

This table will be completed when loading is accomplished. For Mission Planning, reference should be made to Section 4.2 for nominal load, loading tolerances, trapped and deliverable propellants.

	<u>FUEL</u>		<u>OXIDIZER</u>	
	<u>Tank A</u>	<u>Tank B</u>	<u>Tank A</u>	<u>Tank B</u>
A. Tank Volume @ 0.0 PSIA (in ³)	<u>1472.8</u>	<u>1474.5</u>	<u>1788.9</u>	<u>1787.5</u>
B. Liquid Line Volume (in ³)	<u>21.0</u>	<u>17.4</u>	<u>17.1</u>	<u>16.4</u>
C. Total A + B (in ³)	<u>1493.8</u>	<u>1491.9</u>	<u>1806.0</u>	<u>1803.9</u>
D. Initial Weight in Bleed Unit Prior to Loading (lb)	<u>150.0</u>	<u>104.7</u>	<u>198.0</u>	<u>118.0</u>
E. Final Weight in Bleed Unit After Loading (lb)	<u>105.8</u>	<u>60.5</u>	<u>119.8</u>	<u>39.7</u>
F. Propellant Load (item D less than E Weigh Tank)	<u>44.2</u>	<u>44.2</u>	<u>78.2</u>	<u>78.3</u>
G. Propellant Load by P.V.	<u>44.3</u>	<u>44.5</u>	<u>78.6</u>	<u>78.1</u>
H. Loading Temperature (°F)	<u>70.0</u>	<u>70.0</u>	<u>72.0</u>	<u>72.0</u>
I. Specification Propellant Load @ 70±5°F (lb)	<u>44.2±.9</u>	<u>44.2±.9</u>	<u>78.3±1.6</u>	<u>78.3±1.6</u>
J. Total CM/RCS Propellant Load from Item G above (lb)	<u>88.8</u>		<u>156.7</u>	
K. Maximum Trapped Propellant (lb)	<u>13.3</u>		<u>23.1</u>	
L. Nominal Deliverable (lb)	<u>75.5</u>		<u>133.6</u>	



TABLE 3.4-15

SERVICE MODULE RCS LOADING SUMMATION

This table will be completed when loading is accomplished. For Mission Planning, reference should be made to Section 4.2, for nominal load, loading tolerances, and nominal deliverable propellants.

<u>Quad A (lb)</u>		<u>Quad B (lb)</u>	
Secondary fuel	<u>40.3</u>	Secondary fuel	<u>39.8</u>
Primary fuel	<u>69.8</u>	Primary Fuel	<u>70.1</u>
Total fuel	<u>110.1</u> ±0.7	Total fuel	<u>109.9</u> ±0.7
Maximum Trapped	<u>2.1</u>	Maximum Trapped	<u>2.1</u>
Nominal Deliverable	<u>108.0</u>	Nominal Deliverable	<u>107.8</u>
Total Oxidizer	<u>225.3</u> ±2.3	Total Oxidizer	<u>225.2</u> ±2.3
Maximum Trapped	<u>4.5</u>	Maximum Trapped	<u>4.5</u>
Nominal Deliverable	<u>220.8</u>	Nominal Deliverable	<u>220.7</u>
<u>Quad C (lb)</u>		<u>Quad D (lb)</u>	
Secondary fuel	<u>40.4</u>	Secondary fuel	<u>40.0</u>
Primary fuel	<u>70.0</u>	Primary fuel	<u>69.7</u>
Total fuel	<u>110.4</u> ±0.7	Total fuel	<u>109.7</u> ±0.7
Maximum Trapped	<u>2.1</u>	Maximum Trapped	<u>2.1</u>
Nominal Deliverable	<u>108.3</u>	Nominal Deliverable	<u>107.6</u>
Total Oxidizer	<u>226.5</u> ±2.3	Total Oxidizer	<u>223.5</u> ±2.3
Maximum Trapped	<u>4.5</u>	Maximum Trapped	<u>4.5</u>
Nominal Deliverable	<u>222.0</u>	Nominal Deliverable	<u>219.0</u>
<u>Total SM/RCS Propellant Load (lb)</u>			
Total fuel	<u>440.1</u> ±1.4	Total Oxidizer	<u>900.5</u> ±4.6
Maximum Trapped	<u>8.4</u>	Maximum Trapped	<u>18.0</u>
Nominal Deliverable	<u>431.7</u>	Nominal Deliverable	<u>882.5</u>



LM-8 Consumable Loading Requirements

LM-8 APS Propellant

	<u>Fuel (lb)</u>	<u>Oxidizer (lb)</u>
Propellant Load	<u>2007.0</u>	<u>3218.2</u>
Trapped Outside Tanks	<u>5.9</u>	<u>8.3</u>
Tanked	<u>2001.1</u>	<u>3209.9</u>
Trapped Inside Tanks	<u>10.1</u>	<u>27.6</u>
Nominal Deliverable	<u>1991.0</u>	<u>3182.3</u>
Outage	<u>TBD</u>	<u>TBD</u>
Total APS Propellant	<u>TBD</u>	<u>TBD</u>

The following table should be used to determine the amount of propellant to be off-loaded from a full condition to arrive at the indicated load. The allowable tolerance for the calculated off-load is ± 0.5 pounds per weigh tank.

A. Final tank pressure at overfill (PSIG)	<u>60.3</u>	<u>49.3</u>
B. Propellant loading temperature ($^{\circ}$ F)	<u>69.05</u>	<u>68.4</u>
C. Nominal overfill quantity (lb)	<u>2072.3</u>	<u>3307.2</u>
D. Correction for tank pressure (lb)	<u>1.8</u>	<u>1.4</u>
Δ Fuel = 0.09 (Item A-40)		
Δ Oxidizer = 0.15 (Item A-40)		
¹ E. Correction for loading temperature (lb)	<u>-4.7</u>	<u>-9.7</u>
Δ Fuel = -1.16 (Item B-65)		
Δ Oxidizer = -2.84 (Item B-65)		
² F. Measured density (GM/CC)	<u>0.8998</u>	<u>1.4812</u>
² G. Nominal density (GM/CC)	<u>0.8994</u>	<u>1.4824</u>
H. Delta density (GM/CC) (Item F-G)	<u>0.0004</u>	<u>-0.0012</u>
³ I. Correction for measured density	<u>+0.92</u>	<u>-2.76</u>
Δ Fuel = 2300 (Item H)		
Δ Oxidizer = 2300 (Item H)		
J. Propellant in GSE	<u>1.6</u>	<u>4.8</u>
K. Overfill quantity (C+D+E+I+J)	<u>2071.9</u>	<u>3300.9</u>
L. Target loading	<u>2006.7</u>	<u>3218.1</u>
M. Quantity required to fill RCS manifolds	<u>7.9</u>	<u>12.7</u>
N. Quantity to be off-loaded (Items K-L-M)	<u>57.3</u>	<u>70.1</u>

NOTES:

¹Loading temperature correction will always be negative.

²To calculate the nominal density solve the following equation where T= temperature in $^{\circ}$ C of the measured density (usually 4° C for oxidizer and 25° C for fuel). This equation is valid for 14.7 PSIA. Therefore, the measured density must also be at 14.7 PSIA.

Nominal fuel density = $0.922904 - 0.0009377 (^{\circ}\text{C})$

Nominal oxidizer density = $1.491539 - 0.0022832 (^{\circ}\text{C})$

³Correction for measured density may be either positive or negative.

LM-8 Consumable Loading Requirements

LM-8 DPS Propellant

	<u>Fuel (lb)</u>	<u>Oxidizer (lb)</u>
Propellant Load	<u>7072.8</u>	<u>11344.4</u>
Trapped Outside Tanks	<u>35.1</u>	<u>60.5</u>
Tanked	<u>7037.7</u>	<u>11283.9</u>
Trapped Inside Tanks	<u>31.8</u>	<u>134.7</u>
Nominal Deliverable	<u>7007.9</u>	<u>11149.2</u>
Outage	<u>TBD</u>	<u>TBD</u>
Total DPS Propellant Available	<u>TBD</u>	<u>TBD</u>

The following table should be used to determine the amount of propellant to be off-loaded from a full condition to arrive at the indicated load. The allowable tolerance for the calculated off-load is ± 0.5 pounds per weigh tank.

A1. Final tank pressure at overfill (PSIG)	<u>46.1</u>	<u>49.6</u>
B1. Propellant loading temperature (°F)	<u>68.05</u>	<u>67.0</u>
C1. Nominal overfill quantity (lb)	<u>7160.4</u>	<u>11452.9</u>
D1. Correction for tank pressure (lb)	<u>1.9</u>	<u>4.9</u>
Δ Fuel = 0.31 (Item A1-40)	<u>-</u>	<u>-</u>
Δ Oxidizer = 0.51 (Item A1-40)	<u>-</u>	<u>-</u>
¹ E1. Correction for loading temperature (lb)	<u>-12.2</u>	<u>-19.7</u>
Δ Fuel = -4.0 (Item B1-65)		
Δ Oxidizer = -9.85 (Item B1-65)		
² F1. Measured density (GM/CC)	<u>0.8998</u>	<u>1.4812</u>
² G1. Nominal density (GM/CC)	<u>0.8994</u>	<u>1.4824</u>
H1. Delta density (GM/CC) (Item F1-Item G1)	<u>.0004</u>	<u>-0.0012</u>
³ I1. Correction for measured density	<u>3.16</u>	<u>-9.48</u>
Δ Fuel = 7900 (Item H1)		
Δ Oxidizer = 7900 (Item H1)		
J1. Propellant in GSE	<u>2.3</u>	<u>3.8</u>
K1. Overfill quantity (C1+D1+E1+I1+J1)	<u>7155.6</u>	<u>11432.4</u>
L1. Target loading	<u>7072.8</u>	<u>11341.9</u>
M1. Quantity required to fill RCS manifolds (APS only)	<u>xxxxxx</u>	<u>xxxxxx</u>
N1. Quantity to be off-loaded (Items K1-L1-M1)	<u>82.8</u>	<u>90.5</u>

NOTES:

¹Loading temperature correction will always be negative.

²To calculate the nominal density solve the following equation where T=temperature in °C of the measured density (usually 4°C for oxidizer and 25°C for fuel). This equation is valid for 14.7 PSIA. Therefore, the measured density must also be at 14.7 PSIA.

Nominal fuel density = $0.922904 - 0.0009377 (°C)$

Nominal oxidizer density = $1.491539 - 0.0022832 (°C)$

³Correction for measured density may be either positive or negative.



LM-8 - RCS Propellant ⁽²⁾ ⁽³⁾

	Required	Ullage Requirement (in ³)		¹ Actual ⁵	¹ Actual ⁴
	Load (lb) ⁵	Minimum ⁴	Maximum ⁴	Load (lb)	Ullage (in ³)
System A Fuel	107.7±0.9	111.0	123.0	107.7	135.0
System A Oxidizer	208.8±1.9	225.5	237.5	208.8	209.1
System B Fuel	107.7±0.9	111.0	123.0	107.7	128.0
System B Oxidizer	208.8±1.9	225.5	237.5	208.8	258.3

	<u>FUEL</u>	<u>OXIDIZER</u>
Propellant Load	215.4	417.6
Trapped Outside Tanks	10.8	17.6
Tanked	204.6	400.0
Trapped in Tanks	4.2	8.0
Nominal Deliverable	200.4	392.0

LM-8 - Helium & Nitrogen

Consumable	Nominal Loading Requirement			Actual		
	Pressure (PSIA)	Temp (°F)	Weight (lb)	Pressure (PSIA)	Temp (°F)	Weight (lb)
Helium - APS tank #1 (6)	3050	70	6.6	3130	72.9	
- APS tank #2 (6)	3050	70	6.6	3122	72.9	
- RCS tank #1 (6)	3050	70	1.05	3016	70.5	
- RCS tank #2 (6)	3050	70	1.05	3030	70.6	
- DPS (SHe)	80±2	N/A	48.5			
- DPS (Ambient) (6)	1600	70	1.1	1612	68.9	
Nitrogen - Ascent			0.1			
- Descent			0.6			

LM-8 - Water & GOX

Consumable	Nominal Loading Requirement		Actual	
	Pressure (PSIA)	Weight (lb)	Pressure (PSIA)	Weight (lb)
Ascent Water - tank #1	N/A	42.5	N/A	42.5
- tank #2	N/A	42.5	N/A	42.5
Descent Water	N/A	(7)	N/A	254.0
Ascent GOX - tank #1 (6)	830	2.4	850@73°F	2.4
- tank #2 (6)	830	2.4	850@73°F	2.4
Descent GOX (6)	2365	42.0	2377@72°F	42.0

NOTES:

- ¹See Table 3.4-17 for actual propellant load calculation.
- ²See Section 5.6 for explanation of trapped propellants.
- ³See Table 3.4-18 for loading uncertainties.
- ⁴PV ullage calculation should be 125±50 cubic inches for LM/RCS fuel and 238.5±50 cubic inches for LM/RCS oxidizer per tank.
- ⁵LM/RCS required load includes propellant required to fill RCS manifolds to isolation valves. See Table 3.4-16. See Section 5.6 for trapped propellants.
- ⁶The indicated items should be loaded in accordance with loading windows contained in the CSM/LM Spacecraft Operational Data Book, Volume II, Part 2, SNA-8-D-027PT2.
- ⁷LM-8 Descent Water shall be loaded to provide 250-0.0±10.0 pounds at Earth Launch. Initial load will be determined by sampling requirements.



TABLE 3.4-17
LOAD CALCULATION

Amendment 98
1/22/71

<u>APS PROPELLANT</u>		<u>Fuel</u>	<u>Oxidizer</u>
1.	Full tank - Item K, Table 3.4-15 (1b)	<u>2071.9</u>	<u>3300.9</u>
¹ 2.	Density of off-load tables at loading temperature and pressure (lb/ft ³)	-	-
¹ 3.	Propellant volume (divide item 1 by item 2. (ft ³))	-	-
¹ 4.	Measured density (from Table 3.4-19) (lb/ft ³)	-	-
5.	Resulting full tank load (1b)	<u>2071.9</u>	<u>3300.9</u>
6.	Off-load amount (1b)	<u>57.0</u>	<u>70.0</u>
7.	Propellant required to fill RCS manifolds (1b)	<u>7.9</u>	<u>12.7</u>
8.	Propellant load (1b)	<u>2007.0</u>	<u>3218.2</u>
<u>DPS PROPELLANT</u>			
9.	Full tank - Item K1 Table 3.4-16 (1b)	<u>7155.6</u>	<u>11432.4</u>
¹ 10.	Density of off-load tables at loading temperature and pressure (lb/ft ³)	-	-
¹ 11.	Propellant volume (divide Item 9 by Item 10)(ft ³)	-	-
¹ 12.	Measured density (from Table 3.4-19) (lb/ft ³)	-	-
13.	Resulting full tank load (1b)	<u>7155.6</u>	<u>11432.4</u>
14.	Off-load amount (1b)	<u>83.0</u>	<u>88.0</u>
15.	Propellant load (1b)	<u>7072.6</u>	<u>11344.4</u>
<u>RCS PROPELLANT</u>		<u>Fuel</u>	<u>Oxidizer</u>
<u>P. V. Calculations</u>		<u>Tank A</u>	<u>Tank B</u>
A.	GSE Volume (in ³)	<u>18.01</u>	<u>36.7</u>
B.	Initial Ullage Pressure (PSIG)	<u>34.0</u>	<u>32.3</u>
C.	Initial GSE Pressure (PSIG)	<u>0.0</u>	<u>1.8</u>
D.	Final GSE - S/C Pressure (PSIG)	<u>30.0</u>	<u>25.5</u>
E.	Ullage Volume (in ³) - Solve the following equation by substituting the values in the indicated steps.	<u>135.0</u>	<u>128.0</u>
	Ullage Volume = $\frac{(D-C)(A)}{B-D}$	<u>209.1</u>	<u>258.3</u>

NOTE: ¹These items will be completed only if a density sample is not made prior to loading. If a density sample is made prior to loading, then the items will be left blank.



LM-8 Propellant Loading Uncertainties

LM-8 APS PROPELLANT

	<u>Fuel (lb)</u>	<u>Oxidizer (lb)</u>
Vent line Volume	<u>±0.2</u>	<u>±0.3</u>
Tank Volume	<u>±0.8</u>	<u>±1.3</u>
Pressure Measurement (±5 PSIA)	<u>±0.5</u>	<u>±0.8</u>
Temperature Measurement (±1.5°F)	<u>±1.7</u>	<u>±4.3</u>
Measured Density	<u>±0.7</u>	<u>±0.5</u>
² Weight Measurement	<u>±0.5</u>	<u>±0.5</u>
¹ Loading Tolerance	<u>±0.0</u>	<u>±0.0</u>
Total Loading Uncertainty	<u>±4.4</u>	<u>±7.7</u>

LM-8 DPS PROPELLANT

Vent Line Volume	<u>±0.2</u>	<u>±0.3</u>
Tank Volume	<u>±3.4</u>	<u>±5.6</u>
Pressure Measurement (±5 PSIA)	<u>±1.6</u>	<u>±2.6</u>
Temperature Measurement (1.5°F)	<u>±6.1</u>	<u>±14.8</u>
Measured Density	<u>±2.4</u>	<u>±1.6</u>
² Weight Measurement	<u>±0.5</u>	<u>±0.5</u>
¹ Loading Tolerance	<u>±0.5</u>	<u>±0.5</u>
Total Loading Uncertainty	<u>±14.2</u>	<u>±25.4</u>

LM-8 RCS PROPELLANT

Loading Temperature	<u>±0.6</u>	<u>±1.8</u>
Ullage Calculation	<u>±0.4</u>	<u>±0.6</u>
Tank and Manifold Volume	<u>±0.8</u>	<u>±1.4</u>
Total	<u>±1.8</u>	<u>±3.8</u>

¹These will be known quantities after loading is accomplished.

²If weigh tank is used for off-loading, then weight measurement uncertainty is ±0.5 pounds per weigh tank. If flow meter is used for off-loading, then weight measurement uncertainty is ±4.0% of amount off-loaded.

TABLE 3.4-19

LM-8 APS Propellant Loading Parameters
(To Be Completed by KSC at Loading)

	<u>Fuel</u>	<u>Oxidizer</u>
Loading Pressure - PSIA	<u>75.0</u>	<u>64.0</u>
Loading Temperature - Fill Line - Degrees F		
TT 58 Fuel	<u>68.9</u>	<u>67.9</u>
TT258 Oxidizer		
Loading Temperature - Return Line - Degrees F		
TT 59 Fuel	<u>69.2</u>	<u>68.9</u>
TT259 Oxidizer		
Loading Temperature - Tank - Degrees F		
GP0718 Fuel	<u>69.4</u>	<u>68.6</u>
GP1218 Oxidizer		
Number of Times Weigh Tank Used (Flow Meter Not Used)	<u>1</u>	<u>1</u>
Total Pounds Off-Loaded Using Weigh Tank (Flow Meter Not Used)	<u>57</u>	<u>70</u>
Pounds Off-Loaded Using Flow Meter (Weigh Tank Not Used)	<u>--</u>	<u>--</u>
Measured Fuel Density @ 25°C; @ 14.7 PSIA GM/CC	<u>0.8998</u>	<u> </u>
Measured Oxidizer Density @ 4°C; @ 14.7 PSIA GM/CC	<u>--</u>	<u>1.4812</u>

U U E E E E L L E E E E H H E E A A

LM-8 DPS Propellant Loading Parameters

	<u>Fuel</u>	<u>Oxidizer</u>
Loading Pressure - PSIA	<u>60.8</u>	<u>64.3</u>
Loading Temperature - Fill Line - Degrees F TT 58 Fuel TT258 Oxidizer	<u>67.9</u>	<u>67.0</u>
Loading Temperature - Return Line - Degrees F TT 59 Fuel TT259 Oxidizer	<u>68.2</u>	<u>67.0</u>
Loading Temperature - Tank One - Degrees F GQ3718 Fuel GQ4218 Oxidizer	<u>69.0</u>	<u>67.0</u>
Loading Temperature - Tank Two - Degrees F GQ3719 Fuel GQ4219 Oxidizer	<u>68.6</u>	<u>67.4</u>
Number of Times Weigh Tank Used (Flow Meter Not Used)	<u>1</u>	<u>1</u>
Total Pounds Off-Loaded Using Weigh Tank (Flow Meter Not Used)	<u>83</u>	<u>88.0</u>
Pounds Off-Loaded Using Flow Meter (Weigh Tank Not Used)	<u>-</u>	<u>-</u>
Measured Fuel Density @ 25°C; 14.7 PSIA GM/CC	<u>0.8998</u>	<u>-</u>
Measured Oxidizer Density @ 4°C; 14.7 PSIA GM/CC	<u>-</u>	<u>1.4812</u>

U U U E E E L L L E E E H H E E L L L

- Table 3.4-20 presents CSM-110/LM-8 (docked) mass properties, in Apollo coordinates, as a function of spacecraft weight for the Hybrid SM/SPS burn.
- Table 3.4-21 presents CSM-110/LM-8 (docked) mass properties, in Apollo coordinates, as a function of spacecraft weight for L.O.I. SM/SPS burn.
- Table 3.4-22 presents the CSM-110/LM-8 (docked) mass properties, in Apollo coordinates as a function of spacecraft weight for the D.O.I. SM/SPS burn.
- Table 3.4-23 presents the CSM-110 mass properties, in Apollo coordinates, as a function of CSM weight for the Circularization I SM/SPS burn.
- Table 3.4-24 presents the CSM-110 mass properties, in Apollo coordinates, as a function of CSM weight for the Plane Change I SM/SPS burn.
- Table 3.4-25 presents the CSM-110 mass properties, in Apollo coordinates, as a function of CSM weight for the T.E.I. SM/SPS burn.
- Table 3.4-26 presents the LM-8 mass properties, in LM coordinates, as a function of LM weight for the P.D.I. DPS burn.
- Table 3.4-27 presents the LM-8 ascent stage mass properties, in LM coordinates as a function of weight for the lunar lift-off APS burn.
- Table 3.4-28 presents the LM-8 mass properties, in LM coordinates, as a function of LM weight for the T.P.I. burn.



X(A) COORDINATES

TABLE 3.4-20

CSM-110/LM-B HYBRID BURN

WEIGHT LBS.	X-HAR	Y-HAR INCHES	Z-HAR	IXX	IYY	IZZ SLUG-FT SQ	FXV	PYZ	PYZ	PITCH DEGREES	YAW DEGREES	AVPAGE MOMENT	INEPTIA/THRUST RATIO
93014.2	1033.31	2.53	4.04	57050	537456	540368	-8183	-9947	3434	1.009	-.226	538912	1.492
97014.2	1033.06	2.58	4.01	56527	535637	539182	-8170	-9837	3288	1.033	-.231	537509	1.483
95014.2	1033.41	2.57	3.94	56005	533932	537710	-8156	-9714	3142	1.058	-.236	535821	1.472
95014.2	1043.86	2.57	3.87	55482	531713	535924	-8140	-9576	2996	1.083	-.242	533818	1.460
94014.2	1041.90	2.56	3.79	54959	529150	533794	-8122	-9424	2850	1.110	-.248	531472	1.446
93014.2	1043.05	2.55	3.71	54436	526212	531284	-8102	-9256	2705	1.137	-.254	528751	1.431
92014.2	1044.30	2.54	3.63	53912	522865	528376	-8081	-9073	2559	1.164	-.261	525620	1.414
91014.2	1045.66	2.53	3.55	53389	519073	525018	-8057	-8875	2413	1.192	-.268	522045	1.395
90014.2	1047.13	2.52	3.47	52864	514798	521177	-8032	-8659	2267	1.221	-.275	517987	1.375
89014.2	1048.71	2.51	3.38	52340	510000	516813	-8004	-8427	2121	1.251	-.283	513407	1.353
88014.2	1050.42	2.50	3.30	51816	504635	511884	-7975	-8176	1974	1.281	-.291	508260	1.329
87014.2	1052.25	2.49	3.21	51291	498659	506343	-7943	-7908	1828	1.311	-.299	502591	1.303
86014.2	1054.20	2.48	3.12	50765	492023	500142	-7909	-7621	1682	1.342	-.308	496083	1.275
85014.2	1056.29	2.47	3.02	50240	484676	493230	-7873	-7313	1536	1.374	-.317	488953	1.244
84014.2	1058.52	2.45	2.93	49714	476563	485553	-7834	-6986	1390	1.406	-.326	481058	1.212
83014.2	1060.89	2.44	2.83	49189	467623	477049	-7792	-6637	1244	1.438	-.335	472336	1.178
82014.2	1063.41	2.43	2.73	48661	457858	467721	-7749	-6268	1097	1.470	-.345	462789	1.141
81014.2	1066.09	2.42	2.63	48134	447082	457382	-7702	-5874	951	1.504	-.355	452232	1.103
80014.2	1068.12	2.36	2.58	47619	440073	450374	-7592	-5632	844	1.520	-.375	445223	1.076
79014.2	1069.37	2.25	2.60	47116	437975	447792	-7405	-5706	781	1.520	-.405	442883	1.065
78014.2	1070.75	2.13	2.61	46613	434476	444807	-7199	-5731	718	1.520	-.436	440141	1.052
77014.2	1072.24	2.02	2.62	46109	432582	441428	-6973	-5759	655	1.521	-.467	437005	1.038
75014.2	1073.85	1.90	2.64	45605	429295	437655	-6730	-5798	592	1.522	-.499	433475	1.023
75014.2	1075.58	1.77	2.65	45101	425605	433479	-6468	-5820	529	1.523	-.531	429542	1.006
74014.2	1077.44	1.65	2.67	44595	421497	429884	-6188	-5854	466	1.524	-.564	425191	.988
73014.2	1079.42	1.52	2.68	44090	416945	423945	-5889	-5891	403	1.525	-.597	420395	.969
72014.2	1081.52	1.38	2.70	43584	411918	418331	-5570	-5929	341	1.527	-.631	415124	.949
71014.2	1083.77	1.24	2.72	43077	406377	412301	-5231	-5971	278	1.529	-.666	409339	.928
70014.2	1086.16	1.10	2.73	42569	400277	405712	-4870	-6015	216	1.531	-.700	402995	.905
69014.2	1088.70	.96	2.75	42061	393588	398514	-4485	-6061	153	1.533	-.735	396041	.880
68014.2	1091.40	.81	2.77	41553	386196	390651	-4076	-6111	91	1.535	-.771	388423	.854
67014.2	1094.28	.65	2.79	41043	378102	382086	-3642	-6164	28	1.538	-.807	380084	.827
65014.2	1097.33	.49	2.81	40533	369229	372701	-3179	-6220	-33	1.541	-.843	370965	.797
65014.2	1100.57	.33	2.83	40022	359517	362497	-2688	-6279	-95	1.544	-.879	361007	.767
64014.2	1104.01	.16	2.85	39511	348910	351397	-2167	-6342	-157	1.547	-.916	350154	.734
63014.2	1107.65	-.01	2.87	38998	337358	339351	-1614	-6409	-219	1.551	-.953	338354	.700
62014.2	1111.51	-.19	2.89	38485	324615	326313	-1028	-6479	-281	1.555	-.990	325564	.664

X(A) COORDINATES

TABLE 3.4-21

CSM-110/LM-8 L.O.I. BURN

WEIGHT LBS.	X-PAR	Y-PAR INCHES	Z-PAR	IXX	IYY	IZZ SLUG-FT SQ	PXY	PXZ	PYZ	PITCH DEGREES	YAW DEGREES	AVERAGE MOMENT	INERTIA/THRUST RATIO
97842.8	1039.50	2.60	4.15	56934	536971	539903	-8196	-9861	3466	.993	-.225	538437	1.489
96842.8	1039.25	2.59	4.07	56411	535346	538710	-8183	-9752	3320	1.017	-.230	537028	1.480
95842.8	1040.11	2.58	4.00	55889	533435	537231	-8169	-9629	3175	1.042	-.235	535333	1.469
94842.8	1041.06	2.57	3.93	55366	531208	535438	-8153	-9492	3029	1.067	-.241	533323	1.457
93842.8	1042.10	2.56	3.85	54844	528637	533300	-8135	-9341	2883	1.094	-.247	530968	1.443
92842.8	1043.25	2.55	3.77	54321	525690	530785	-8115	-9175	2737	1.120	-.253	528238	1.428
91842.8	1044.51	2.55	3.70	53797	522332	527862	-8094	-8993	2591	1.148	-.260	525097	1.411
90842.8	1045.87	2.54	3.62	53274	518529	524492	-8071	-8796	2445	1.176	-.267	521511	1.392
89842.8	1047.35	2.53	3.53	52750	514242	520639	-8045	-8582	2299	1.205	-.274	517440	1.372
88842.8	1048.94	2.52	3.45	52226	509430	516262	-8018	-8351	2153	1.234	-.282	512846	1.350
87842.8	1050.65	2.51	3.36	51701	504052	511317	-7989	-8102	2007	1.264	-.290	507684	1.326
86842.8	1052.48	2.50	3.27	51177	498059	505760	-7957	-7836	1861	1.295	-.298	501910	1.300
85842.8	1054.45	2.48	3.18	50652	491406	499541	-7923	-7550	1715	1.326	-.307	495474	1.272
84842.8	1056.54	2.47	3.09	50126	484040	492610	-7887	-7245	1569	1.357	-.316	488325	1.241
83842.8	1058.78	2.46	3.00	49601	475906	484913	-7848	-6920	1422	1.389	-.325	480409	1.209
82842.8	1061.16	2.45	2.90	49075	466944	476386	-7807	-6573	1276	1.421	-.334	471665	1.175
81842.8	1063.68	2.44	2.80	48549	457154	467033	-7764	-6207	1130	1.454	-.344	462094	1.138
80842.8	1066.37	2.43	2.70	48022	446352	456668	-7717	-5816	984	1.487	-.354	451510	1.100
79842.8	1069.41	2.37	2.65	47506	439323	449639	-7608	-5627	877	1.504	-.374	444481	1.073
78842.8	1069.67	2.25	2.67	47004	437213	447045	-7420	-5652	814	1.504	-.404	442129	1.062
77842.8	1071.05	2.14	2.68	46501	434699	444044	-7213	-5679	751	1.504	-.435	439372	1.049
76842.8	1072.55	2.02	2.70	45997	431790	440652	-6988	-5708	688	1.504	-.466	436221	1.035
75842.8	1074.17	1.90	2.71	45493	428486	436862	-6744	-5740	625	1.505	-.498	432674	1.020
74842.8	1075.91	1.78	2.73	44988	424778	432668	-6482	-5774	562	1.506	-.530	428723	1.003
73842.8	1077.78	1.65	2.75	44483	420649	428053	-6201	-5811	500	1.507	-.563	424351	.985
72842.8	1079.76	1.52	2.76	43977	416076	422992	-5901	-5849	437	1.508	-.596	419534	.966
71842.8	1031.84	1.39	2.76	43471	411026	417454	-5582	-5891	375	1.510	-.630	414240	.946
70842.8	1084.14	1.25	2.80	42964	405480	411400	-5242	-5935	312	1.511	-.665	408430	.924
69842.8	1086.54	1.11	2.82	42457	399333	404784	-4880	-5982	250	1.513	-.699	402058	.901
68842.8	1089.09	.96	2.83	41949	392594	397556	-4495	-6032	188	1.515	-.735	395075	.877
67842.8	1091.81	.81	2.85	41440	385190	389661	-4086	-6085	125	1.518	-.770	387425	.851
66842.8	1094.69	.66	2.87	40931	377061	381042	-3650	-6141	63	1.520	-.806	379052	.823
65842.8	1097.76	.50	2.89	40421	368151	371640	-3187	-6201	1	1.523	-.842	369895	.794
64842.8	1101.02	.33	2.92	39910	358398	361395	-2695	-6265	-60	1.526	-.879	359897	.763
63842.8	1104.47	.16	2.94	39398	347748	350252	-2173	-6332	-122	1.530	-.915	349000	.731
62842.8	1108.13	-.01	2.96	38886	336149	338159	-1619	-6404	-183	1.533	-.952	337154	.696
61842.8	1112.01	-.19	2.98	38372	323555	325070	-1032	-6479	-245	1.537	-.989	324312	.660

X(A) COORDINATES

TABLE 3.4-21 (CONTINUED)

CSM-110/LM-R L.O.T. BURN

WEIGHT LBS.	X-PAK	Y-BAK INCHES	Z-BAK	IXX	IYY	IZZ SLUG-FT SQ	PXY	PXZ	PYZ	PITCH DEGREES	YAW DEGREES	AVERAGE MOMENT	INERTIA/THROUST RATIO
60842.8	1116.11	-0.38	3.01	37858	209882	310902	-416	-6560	-306	1.541	-1.026	310392	.623
59842.8	1120.46	-0.57	3.03	37343	295061	295585	243	-6644	-368	1.545	-1.064	295323	.584
58842.8	1125.05	-0.77	3.06	36826	279006	279032	939	-6733	-429	1.550	-1.101	279019	.543
57842.8	1129.54	-0.97	3.08	36309	261434	260962	1680	-6829	-490	1.555	-1.138	261198	.500

XIAX COORDINATES

TABLE 3.4-22

CSM-110/LME D.O.I. BURN

WEIGHT LBS.	X-PAR	Y-PAR INCHES	Z-PAR	IXX	IYY	IZZ SLUG-FT SQ	PXY	PXZ	PYZ	PITCH DEGREES	YAW	AVERAGE MOMENT	INERTIA/THAUST RATIO
97803.4	1032.58	2.60	4.15	56898	537007	539944	-8201	-9865	3475	.993	-.225	536475	1.489
96803.4	1039.33	2.59	4.08	56376	535380	538749	-8188	-9757	3329	1.017	-.230	537064	1.479
95803.4	1040.19	2.58	4.00	55854	533465	537267	-8174	-9634	3183	1.042	-.235	535366	1.469
94803.4	1041.14	2.57	3.93	55331	531236	535470	-8158	-9497	3038	1.068	-.241	533353	1.456
93803.4	1042.14	2.57	3.85	54809	528661	533328	-8140	-9345	2892	1.094	-.247	530995	1.443
92803.4	1043.34	2.56	3.78	54285	525710	530810	-8121	-9179	2746	1.121	-.253	528260	1.427
91803.4	1044.60	2.55	3.70	53762	522348	527882	-8099	-8997	2600	1.146	-.260	525115	1.410
90803.4	1045.56	2.54	3.62	53239	518540	524508	-8076	-8799	2454	1.176	-.267	521524	1.392
89803.4	1047.44	2.53	3.53	52715	514248	520650	-8051	-8585	2308	1.205	-.274	517449	1.371
88803.4	1049.03	2.52	3.45	52191	509431	516267	-8023	-8354	2162	1.235	-.282	512849	1.349
87803.4	1050.74	2.51	3.36	51666	504046	511316	-7994	-8106	2016	1.265	-.290	507681	1.325
86803.4	1052.58	2.50	3.27	51142	498047	505753	-7963	-7839	1870	1.295	-.298	501900	1.299
85803.4	1054.45	2.49	3.18	50617	491387	499527	-7929	-7554	1724	1.326	-.307	495457	1.271
84803.4	1056.44	2.48	3.09	50091	484013	492588	-7893	-7248	1578	1.358	-.315	488301	1.241
83803.4	1058.88	2.46	3.00	49566	475871	484883	-7854	-6923	1431	1.389	-.325	480377	1.209
82803.4	1061.26	2.45	2.90	49040	466900	476347	-7813	-6576	1285	1.422	-.334	471624	1.174
81803.4	1063.70	2.44	2.80	48513	457101	466985	-7769	-6210	1139	1.454	-.344	462043	1.138
80803.4	1066.48	2.43	2.70	47987	446285	456609	-7723	-5818	993	1.487	-.354	451449	1.099
79803.4	1068.52	2.37	2.65	47471	439252	449573	-7614	-5625	886	1.504	-.374	444412	1.072
78803.4	1069.78	2.26	2.67	46969	437137	446973	-7426	-5654	823	1.504	-.404	442055	1.061
77803.4	1071.17	2.14	2.68	46465	434617	443969	-7219	-5681	760	1.504	-.434	439293	1.048
76803.4	1072.47	2.02	2.70	45962	431702	440569	-6993	-5711	697	1.505	-.466	436136	1.034
75803.4	1074.29	1.90	2.71	45458	428392	436773	-6749	-5742	634	1.505	-.498	432532	1.019
74803.4	1076.04	1.78	2.73	44953	424677	432572	-6486	-5776	571	1.506	-.530	428624	1.002
73803.4	1077.90	1.65	2.75	44448	420541	427949	-6205	-5813	509	1.507	-.563	424245	.984
72803.4	1079.89	1.52	2.76	43942	415960	422881	-5906	-5852	446	1.508	-.596	419420	.965
71803.4	1082.01	1.39	2.78	43436	410901	417334	-5586	-5893	384	1.510	-.630	414118	.945
70803.4	1084.27	1.25	2.80	42929	405326	411271	-5246	-5937	321	1.512	-.664	408298	.923
69803.4	1086.68	1.11	2.82	42422	399189	404645	-4884	-5984	255	1.514	-.699	401917	.900
68803.4	1089.23	.96	2.83	41914	392439	397406	-4499	-6034	197	1.516	-.734	394923	.876
67803.4	1091.55	.81	2.85	41405	385023	389500	-4089	-6088	134	1.518	-.770	387262	.850
66803.4	1094.44	.66	2.87	40896	376883	380869	-3653	-6144	72	1.521	-.806	378876	.822
65803.4	1097.91	.50	2.89	40386	367959	371453	-3190	-6204	10	1.524	-.842	369706	.793
64803.4	1101.17	.34	2.92	39875	358193	361194	-2697	-6267	-51	1.527	-.878	359693	.762
63803.4	1104.43	.17	2.94	39363	347527	350036	-2174	-6335	-113	1.530	-.915	348782	.730
62803.4	1108.30	-.01	2.96	38851	335911	337926	-1620	-6406	-174	1.534	-.952	336918	.695
61803.4	1112.18	-.19	2.98	38337	323249	324820	-1033	-6482	-236	1.537	-.989	324060	.660

Amendment 98
1/22/71

X(A) COORDINATES

TABLE 3.4-22 (CONTINUED)

CSM-110/L48 D.O.I. BURN

WEIGHT LBS.	X-PAN	Y-BAR INCHES	Z-BAR	IXX	IYY	IZZ SLUG-FT SQ	PXY	PXZ	PYZ	PITCH DEGREES	YAW	AVERAGE MOMENT	INERTIA/THRUST RATIO
60803.4	1116.29	-.38	3.01	37823	309607	310632	-417	-6563	-297	1.541	-1.026	310120	.622
59803.4	1120.64	-.57	3.03	37308	294766	295295	243	-6647	-359	1.546	-1.063	295031	.583
58303.4	1125.24	-.77	3.06	36791	278689	278720	939	-6736	-420	1.550	-1.101	278705	.542
57803.4	1130.14	-.97	3.08	36274	261094	260626	1680	-6832	-481	1.555	-1.138	260860	.499

XI) COORDINATES

TABLE 3.4-23

CSM-110 CIRCULARIZATION BURN

WEIGHT LBS.	X-PAK	Y-BAP INCHES	Z-RAP	IXX	IYY	IZZ SLUG-FT SQ	PXY	PXZ	PVZ	PITCH DEGREES	YAW DEGREES	AVERAGE MOMENT	INERTIA/THRUST RATIO
63435.2	933.64	3.96	6.59	33798	75493	78037	-1895	-121	3177	-1.601	1.306	76765	.434
62435.2	933.14	3.97	6.51	33282	74830	77801	-1892	-153	3033	-1.579	1.322	76315	.434
61435.2	932.74	3.97	6.44	32766	74248	77646	-1889	-175	2889	-1.552	1.336	75947	.433
60435.2	932.45	3.99	6.36	32250	73729	77554	-1888	-198	2745	-1.519	1.348	75642	.433
59435.2	932.28	3.99	6.29	31733	73253	77504	-1887	-205	2601	-1.480	1.358	75379	.432
58435.2	932.23	4.00	6.20	31217	72799	77477	-1887	-213	2457	-1.435	1.365	75138	.431
57435.2	932.30	4.01	6.12	30700	72344	77450	-1887	-210	2313	-1.384	1.369	74897	.429
56435.2	932.51	4.02	6.03	30183	71866	77399	-1889	-198	2170	-1.327	1.370	74632	.427
55435.2	932.86	4.03	5.94	29666	71339	77299	-1892	-177	2026	-1.263	1.368	74319	.423
54435.2	923.35	4.05	5.85	29148	70736	77123	-1896	-148	1882	-1.193	1.363	73929	.419
53435.2	934.00	4.06	5.75	28630	70027	76843	-1901	-109	1738	-1.117	1.355	73435	.414
52435.2	934.81	4.07	5.65	28113	69183	76427	-1907	-59	1594	-1.034	1.344	72805	.407
51435.2	935.80	4.08	5.55	27594	68168	75841	-1914	C	1450	-.945	1.329	72005	.398
50435.2	936.97	4.10	5.44	27076	66948	75049	-1923	71	1307	-.850	1.310	70998	.388
49435.2	938.35	4.11	5.33	26557	65482	74011	-1933	155	1163	-.750	1.288	69746	.377
48435.2	939.93	4.12	5.21	26039	63722	72681	-1944	252	1019	-.644	1.263	68202	.363
47435.2	941.73	4.14	5.09	25519	61646	71034	-1958	361	875	-.533	1.234	66340	.347
46435.2	943.78	4.15	4.96	25000	59157	68976	-1973	497	732	-.417	1.202	64066	.329
45435.2	944.67	4.09	4.93	24490	57582	67402	-2010	562	628	-.382	1.149	62492	.318
44435.2	944.12	3.93	5.01	23990	57495	66839	-2051	580	568	-.434	1.077	62167	.318
43435.2	943.71	3.76	5.09	23491	57438	66304	-2082	593	508	-.486	.999	61871	.318
42435.2	943.42	3.59	5.17	22990	57404	65794	-2103	602	449	-.536	.913	61599	.317
41435.2	943.27	3.40	5.26	22489	57390	65302	-2114	607	390	-.585	.821	61346	.316
40435.2	943.25	3.21	5.35	21987	57386	64820	-2117	608	331	-.634	.722	61103	.315
39435.2	943.38	3.01	5.45	21484	57383	64339	-2109	603	273	-.681	.615	60861	.314
38435.2	943.65	2.80	5.55	20981	57369	63845	-2092	594	215	-.727	.502	60607	.312
37435.2	944.08	2.59	5.66	20476	57328	63325	-2063	580	157	-.771	.381	60326	.309
36435.2	944.68	2.34	5.77	19970	57242	62759	-2023	559	100	-.814	.253	60000	.306
35435.2	945.48	2.09	5.89	19463	57090	62126	-1969	532	43	-.854	.117	59608	.301
34435.2	946.49	1.83	6.02	18955	56848	61402	-1901	499	-12	-.891	-.025	59125	.296
33435.2	947.73	1.55	6.15	18446	56487	60559	-1816	457	-68	-.925	-.174	58523	.290
32435.2	949.24	1.25	6.30	17935	55978	59566	-1713	406	-122	-.956	-.331	57772	.283
31435.2	951.03	.94	6.45	17423	55286	58389	-1589	346	-178	-.982	-.493	56837	.274
30435.2	953.15	.60	6.61	16908	54374	56992	-1444	275	-232	-1.004	-.661	55683	.264
29435.2	955.62	.25	6.78	16392	53203	55334	-1273	193	-785	-1.021	-.835	54269	.252
28435.2	958.48	-.14	6.97	15874	51734	53376	-1075	97	-237	-1.033	-1.013	52555	.238
27435.2	961.76	-.55	7.17	15353	49923	51076	-.848	-11	-389	-1.040	-1.194	50500	.223

X(A) COORDINATES

TABLE 3.4-23 (CONTINUED)

CSM-110 CIRCULARIZATION BURN

WEIGHT LBS.	X-BAK	Y-BAK INCHFS	Z-BAK	IXX	IYY	IZZ SLUG-FT SQ	PXY SG	PXZ	PYZ	PITCH DEGREES	YAW	AVERAGE MOMENT	INERTIA/THRUST RATIO
26435.2	965.52	-0.99	7.38	14830	47708	48370	-593	-138	-439	-1.042	-1.379	49039	.206
25435.2	965.82	-1.47	7.61	14303	45019	45187	-292	-281	-488	-1.038	-1.566	45103	.187
24435.2	974.71	-1.96	7.96	13774	41779	41452	47	-444	-536	-1.028	-1.753	41615	.167
23435.2	987.38	-2.54	8.12	13240	37829	37004	440	-634	-593	-1.011	-1.940	37417	.144

(A) COORDINATES

TABLE 3.4-24

CSM-110 PLANE CHANGE I

WEIGHT LBS.	X-BAR INCHES	Y-BAR INCHES	Z-BAR	IXX	IYY	IZZ SLUG-FT SQ	PXY	PXZ	PYZ	PITCH DEGREES	YAW	AVERAGE MOMENT	INERTIA/THRUST RATIO
62331.9	933.67	3.97	6.58	33705	75463	78020 -1901	-121	3203	-1.599	1.312	76741	.434	
62331.9	933.16	3.98	6.51	33189	74800	77784 -1897	-153	3059	-1.577	1.328	76292	.433	
61331.9	932.77	3.99	6.44	32673	74219	77629 -1895	-178	2915	-1.549	1.342	75924	.433	
60331.9	932.48	4.00	6.36	32157	73700	77537 -1893	-197	2771	-1.516	1.354	75619	.432	
59331.9	932.31	4.00	6.28	31640	73224	77488 -1892	-205	2627	-1.477	1.364	75356	.432	
58331.9	932.25	4.02	6.20	31123	72770	77461 -1892	-213	2483	-1.432	1.371	75115	.431	
57331.9	932.33	4.03	6.12	30607	72315	77433 -1893	-209	2339	-1.381	1.375	74874	.429	
56331.9	932.54	4.04	6.03	30090	71837	77382 -1894	-197	2195	-1.324	1.377	74609	.426	
55331.9	932.88	4.05	5.94	29572	71309	77282 -1897	-177	2051	-1.260	1.375	74296	.423	
54331.9	933.38	4.06	5.85	29055	70705	77106 -1901	-147	1907	-1.190	1.370	73906	.419	
53331.9	934.03	4.07	5.75	28537	69997	76825 -1906	-108	1763	-1.113	1.362	73411	.413	
52331.9	934.85	4.08	5.65	28019	69151	76409 -1912	-58	1619	-1.030	1.351	72780	.407	
51331.9	935.64	4.10	5.54	27501	68136	75822 -1920	1	1476	-.941	1.336	71797	.398	
50331.9	937.01	4.11	5.43	26983	66915	75029 -1929	73	1332	-.846	1.317	70972	.388	
49331.9	939.39	4.12	5.32	26464	65447	73990 -1939	157	1188	-.745	1.295	69719	.376	
48331.9	939.98	4.14	5.20	25945	63686	72659 -1951	254	1045	-.639	1.270	68173	.363	
47331.9	941.78	4.15	5.08	25426	61608	71010 -1965	363	901	-.528	1.241	66309	.347	
46331.9	943.84	4.17	4.95	24906	59117	68949 -1980	488	757	-.412	1.209	64033	.329	
45331.9	944.73	4.19	4.92	24396	57541	67374 -2017	564	653	-.377	1.156	62457	.318	
44331.9	944.18	3.94	5.00	23897	57455	66812 -2058	582	594	-.429	1.084	62133	.318	
43331.9	943.77	3.78	5.08	23397	57348	66278 -2088	595	534	-.480	1.006	61838	.318	
42331.9	943.49	3.60	5.16	22897	57365	65768 -2109	604	475	-.530	.920	61556	.317	
41331.9	943.34	3.42	5.25	22396	57350	65276 -2121	605	416	-.580	.828	61313	.316	
40331.9	943.32	3.23	5.34	21894	57346	64794 -2123	605	357	-.628	.729	61070	.315	
39331.9	943.44	3.03	5.44	21391	57343	64313 -2116	605	298	-.675	.622	60828	.313	
38331.9	943.72	2.81	5.54	20888	57329	63814 -2098	596	240	-.721	.509	60574	.311	
37331.9	944.15	2.59	5.65	20383	57287	63298 -2070	581	183	-.766	.388	60293	.309	
36331.9	944.76	2.36	5.76	19877	57201	62731 -2029	561	125	-.808	.260	59946	.305	
35331.9	945.56	2.11	5.88	19371	57048	62097 -1975	534	68	-.848	.124	59573	.301	
34331.9	946.57	1.84	6.01	18863	56804	61372 -1907	500	12	-.885	-.019	59088	.296	
33331.9	947.82	1.56	6.15	18353	56442	60527 -1822	458	-43	-.919	-.168	58445	.290	
32331.9	947.34	1.27	6.24	17843	55931	59532 -1719	408	-98	-.950	-.325	57732	.282	
31331.9	951.14	.95	6.44	17330	55236	58353 -1595	348	-153	-.976	-.487	56794	.273	
30331.9	953.27	.62	6.60	16816	54321	56952 -1449	277	-207	-.998	-.656	55637	.263	
29331.9	955.75	.26	6.78	16300	53146	55291 -1279	194	-260	-1.015	-.830	54219	.251	
28331.9	959.63	-.13	6.96	15782	51672	53328 -1081	95	-312	-1.027	-1.008	52500	.238	
27331.9	961.93	-.54	7.16	15261	49855	51021 -853	-10	-364	-1.034	-1.190	50438	.222	

Amendment 98
1/22/71

Y(A) COORDINATES

TABLE 3.4-24 (CONTINUED)

CSM-110 PLANE CHANGE 1

WEIGHT LBS.	X-PAR	Y-PAR INCHES	Z-PAR	IXX	IYY	IZZ SLUG-FT SQ	PXY	PXZ	PYZ	DEGREES		AVERAGE MOMENT	INERTIA/THRUST RATIO
										PITCH	YAW		
26331.9	965.71	-0.98	7.38	14738	47632	48308	-598	-137	-414	-1.036	-1.375	47970	.206
25331.9	970.03	-1.46	7.61	14211	44933	45115	-296	-280	-463	-1.032	-1.562	45024	.187
24331.9	974.56	-1.98	7.86	13682	41681	41368	43	-444	-511	-1.022	-1.750	41524	.166
23331.9	980.66	-2.54	8.13	13148	37716	36905	436	-633	-558	-1.005	-1.938	37310	.144

Amendment 98
1/22/71

YA COORDINATES

TABLE 3.4-25

CSM-110 T.E.I. 6/JPN

WEIGHT LBS.	X-PAR	Y-BAR INCHES	Z-BAR	IXX	IYY	IZZ SLUG-FT SQ	PXY	PXZ	PYZ	PITCH DEGREES	YAW DEGREES	AVERAGE MOMENT	INERTIA/THRUST RATIO
63563.0	934.14	4.05	6.44	33600	75441	78007	-1795	-272	3249	-1.503	1.348	76724	.432
62563.0	933.44	4.06	6.37	33084	74785	77778	-1791	-304	3105	-1.479	1.365	76281	.431
61563.0	933.25	4.07	6.30	32568	74709	77628	-1788	-330	2961	-1.450	1.380	75918	.431
60563.0	932.94	4.08	6.22	32051	73693	77539	-1786	-345	2817	-1.415	1.393	75616	.430
59563.0	932.81	4.09	6.14	31534	73219	77492	-1785	-360	2673	-1.375	1.403	75356	.430
58563.0	932.77	4.11	6.05	31017	72765	77466	-1785	-364	2529	-1.329	1.411	75115	.428
57563.0	932.86	4.12	5.97	30500	72309	77437	-1786	-359	2386	-1.276	1.416	74873	.427
56563.0	933.07	4.13	5.88	29982	71827	77383	-1788	-346	2242	-1.217	1.418	74605	.424
55563.0	933.43	4.14	5.78	29465	71295	77279	-1791	-325	2098	-1.153	1.417	74287	.421
54563.0	933.93	4.16	5.69	28947	70685	77096	-1796	-293	1954	-1.082	1.413	73890	.417
53563.0	934.59	4.17	5.59	28429	69967	76807	-1802	-252	1811	-1.005	1.405	73387	.411
52563.0	935.41	4.19	5.48	27911	69111	76380	-1809	-201	1667	-.921	1.394	72745	.404
51563.0	936.41	4.20	5.38	27392	68083	75780	-1818	-138	1523	-.832	1.380	71931	.396
50563.0	937.59	4.21	5.26	26873	66846	74972	-1828	-63	1380	-.737	1.362	70909	.386
49563.0	938.57	4.23	5.15	26354	65361	73916	-1840	23	1236	-.637	1.340	69639	.374
48563.0	940.57	4.25	5.03	25835	63580	72565	-1854	124	1093	-.531	1.315	68072	.360
47563.0	942.37	4.26	4.90	25315	61479	70894	-1869	237	945	-.421	1.287	66187	.344
46563.0	944.43	4.28	4.77	24795	58963	68809	-1887	367	806	-.305	1.255	63886	.326
45563.0	945.33	4.22	4.74	24285	57376	67223	-1925	444	702	-.269	1.203	62300	.315
44563.0	944.80	4.06	4.81	23786	57297	66668	-1964	460	642	-.318	1.134	61982	.315
43563.0	944.40	3.90	4.89	23287	57244	66139	-1993	473	582	-.366	1.058	61692	.315
42563.0	944.14	3.73	4.96	22788	57215	65633	-2013	481	522	-.412	.975	61424	.314
41563.0	944.00	3.55	5.05	22287	57202	65143	-2023	485	462	-.458	.885	61173	.313
40563.0	944.00	3.36	5.13	21786	57199	64662	-2024	485	403	-.503	.788	60930	.312
39563.0	944.14	3.17	5.23	21284	57195	64179	-2016	480	344	-.547	.684	60687	.311
38563.0	944.43	2.96	5.32	20781	57177	63683	-1997	471	286	-.589	.574	60430	.308
37563.0	944.88	2.74	5.42	20278	57131	63157	-1968	456	227	-.630	.456	60144	.306
36563.0	945.51	2.51	5.53	19773	57038	62583	-1927	436	169	-.669	.331	59811	.302
35563.0	946.32	2.27	5.64	19267	56876	61941	-1873	410	112	-.705	.198	59408	.298
34563.0	947.35	2.01	5.76	18760	56621	61204	-1804	378	55	-.739	.059	58912	.293
33563.0	948.62	1.74	5.89	18252	56245	60346	-1719	338	-1	-.770	-.087	58295	.287
32563.0	950.15	1.45	6.02	17743	55716	59334	-1616	289	-57	-.797	-.240	57525	.279
31563.0	951.96	1.14	6.16	17232	55002	58135	-1493	231	-112	-.821	-.399	56568	.270
30563.0	954.10	.82	6.32	16719	54064	56712	-1348	164	-167	-.840	-.564	55388	.260
29563.0	956.59	.47	6.48	16204	52863	55025	-1179	85	-221	-.855	-.734	53944	.248
28563.0	959.47	.09	6.65	15688	51359	53032	-.983	-5	-274	-.865	-.908	52195	.235
27563.0	962.78	-.31	6.84	15169	49509	50693	-758	-109	-327	-.870	-1.087	50101	.220

Amendment 98
1/22/71

XA COORDINATES

TABLE 3.4-25 (CONTINUED)

CSM-110 T.E.I. BURN

WEIGHT LBS.	X-PAR	Y-BAR INCHES	Z-BAR	IXX	IYY	IZZ	PXY	PXZ	PYZ	PITCH DEGREES	YAW	AVERAGE MOMENT	INERTIA/THRUST RATIO
26263.0	986.56	-0.74	7.04	14648	47250	47943	-505	-230	-378	-0.871	-1.268	47596	.203
25563.0	970.87	-1.21	7.25	14124	44510	44711	-208	-366	-429	-0.866	-1.452	44611	.184
24562.0	975.79	-1.71	7.45	13596	41215	40921	127	-521	-478	-0.855	-1.636	41068	.164
23562.0	981.47	-2.25	7.74	13065	37202	36412	514	-701	-526	-0.838	-1.821	36807	.141

TABLE 3.4-26
LM-8 PRE P.O.I. TO TOUCHDOWN
DEGREES

WEIGHT LBS.	X-BAY INCHES	Y-BAY INCHES	Z-BAY	IKK	IYY	IZZ SLUG-FT SU	PAY SU	PAZ	PVZ	PILOT ROLL DEGREES
3473.1	105.71	-0.22	.71	23923	24093	24028	174	764	367	-1.202
33473.7	146.22	-0.22	.73	23607	25875	25881	175	766	367	-1.249
33368.3	146.53	-0.21	.69	23290	25651	25728	175	767	368	-1.217
32465.9	146.83	-0.20	.68	22973	25423	25572	174	769	368	-1.185
32033.5	147.13	-0.20	.67	22656	25191	25412	173	770	369	-1.152
31541.1	147.44	-0.19	.65	22340	24956	25248	173	771	370	-1.119
31358.7	147.75	-0.18	.64	22023	24718	25081	172	773	370	-1.084
30556.3	148.08	-0.17	.63	21706	24477	24912	171	774	371	-1.053
29511.5	148.41	-0.16	.61	21389	24233	24739	170	776	371	-1.019
29049.1	148.76	-0.16	.60	21073	23986	24564	169	778	372	-0.988
28094.3	149.12	-0.15	.58	20756	23735	24388	168	781	373	-0.950
27139.5	149.47	-0.16	.60	20439	23484	24214	169	780	374	-0.917
26184.7	150.72	-0.17	.62	19551	22744	23666	170	780	375	-0.963
25229.9	151.70	-0.19	.64	18948	22217	23275	171	779	377	-0.968
24275.1	152.41	-0.20	.66	18346	21657	22882	173	779	378	-0.971
23320.3	153.09	-0.22	.68	17743	21051	22302	175	779	379	-0.972
22365.5	153.56	-0.24	.70	17141	20395	21862	177	778	381	-0.971
21410.7	154.23	-0.26	.73	16538	19681	21284	180	776	382	-0.969
20455.9	154.93	-0.28	.76	15936	18903	20642	183	773	384	-0.964
19501.1	155.29	-0.30	.79	15333	18058	19933	188	769	385	-0.959
18546.3	156.69	-0.33	.83	14731	17150	19161	194	761	387	-0.952
17591.5	158.67	-0.34	.86	14129	16708	18851	195	757	387	-0.970
16770.3	160.70	-0.35	.89	13527	16409	18525	198	749	388	-0.987
16004.9	162.78	-0.37	.92	12925	16022	18189	201	742	389	-1.004
15239.5	164.90	-0.38	.96	12323	15625	17844	204	734	389	-1.021
14474.1	167.07	-0.39	1.00	11721	15217	17489	207	726	390	-1.038
13708.7	169.28	-0.41	1.04	11119	14799	17123	211	717	391	-1.055
12943.3	171.55	-0.42	1.08	10517	14370	16745	214	708	392	-1.072
12177.9	173.88	-0.44	1.12	9915	13928	16355	218	699	392	-1.089
11412.5	176.26	-0.46	1.16	9313	13473	15952	221	689	393	-1.106

This page intentionally left blank.

U U E E E L L E E E E E E E E E E E E

Figure 98
1/22/71

TABLE 3.4-27 LM-4 AS LUNAR LIFTOFF TO INSERTION

WEIGHT LBS.	X-PAR	Y-PAR INCHES	Z-PAR	IXX	IYY	IZZ SLUG-FT	PXY SC.	PKZ	PYZ	ROLL MOMENT OFFSET (DEG./SEC. SQ.)	PITCH MOMENT
10334.0	244.26	.09	2.86	6779	3456	5961	64	214	7	.245	5.669
10374.0	244.66	.09	2.93	6601	3440	5768	64	211	7	.262	5.427
10314.0	245.03	.09	3.00	6422	3424	5574	64	209	7	.281	5.150
10054.0	245.52	.10	3.08	6243	3407	5379	64	206	7	.301	4.856
9794.0	245.98	.10	3.16	6065	3390	5183	63	202	6	.324	4.543
9534.0	246.47	.11	3.25	5886	3374	4987	63	196	6	.350	4.209
9274.0	246.99	.11	3.34	5707	3359	4789	63	196	6	.378	3.852
9014.0	247.54	.11	3.43	5529	3327	4590	63	192	6	.410	3.470
8754.0	248.12	.12	3.54	5350	3305	4390	63	188	6	.446	3.060
8494.0	248.73	.12	3.64	5171	3281	4189	63	184	6	.486	2.619
8234.0	249.39	.13	3.76	4992	3255	3985	62	180	6	.532	2.142
7974.0	250.09	.13	3.88	4813	3228	3781	62	175	6	.584	1.626
7714.0	250.83	.14	4.01	4634	3199	3574	62	170	6	.645	1.066
7454.0	251.63	.15	4.15	4455	3167	3366	62	165	6	.715	.455
7194.0	252.48	.15	4.30	4276	3134	3155	62	155	6	.798	-.214
6934.0	253.40	.16	4.46	4097	3098	2942	61	153	6	.896	-.949
6674.0	254.39	.17	4.64	3917	3059	2726	61	146	6	1.013	-1.760
6414.0	255.46	.18	4.82	3738	3017	2508	61	139	6	1.157	-2.601
6154.0	256.62	.18	5.02	3559	2972	2285	60	131	6	1.335	-3.666
5894.0	257.88	.19	5.25	3379	2922	2059	60	123	6	1.560	-4.796

Amendment 98
1/22/71

XE COORDINATES

TABLE 3.4-26

LM-R T.P.I. EURN

HEIGHT LBS.	X-PAN	Y-BAP INCHES	Z-BAP	IXX	IYY	IZZ SLUG-FT SC.	PXY	PXZ	PYZ	ROLL MOMENT OFFSET (DEG./SEC. SQ.)	PITCH MOMENT
6130.4	256.23	.19	5.08	3561	2944	2286	60	134	R	1.389	-4.036
6104.4	256.35	.19	5.10	3543	2960	2263	60	133	R	1.410	-4.146
6078.4	256.47	.19	5.13	3525	2955	2241	60	132	R	1.432	-4.257
6052.4	256.59	.20	5.15	3507	2950	2219	60	131	R	1.454	-4.369
6026.4	256.72	.20	5.17	3489	2945	2196	60	131	R	1.476	-4.483
6000.4	256.84	.20	5.19	3471	2941	2174	60	130	R	1.499	-4.598
5974.4	256.97	.20	5.22	3453	2936	2151	60	129	R	1.523	-4.714
5948.4	257.09	.20	5.24	3435	2931	2129	60	128	R	1.547	-4.832
5922.4	257.22	.20	5.26	3417	2926	2106	60	127	R	1.571	-4.951
5896.4	257.35	.20	5.28	3399	2921	2083	60	126	R	1.597	-5.071
5870.4	257.48	.20	5.31	3381	2916	2061	60	125	R	1.623	-5.194
5844.4	257.61	.20	5.33	3363	2911	2038	60	125	R	1.650	-5.317
5818.4	257.74	.20	5.36	3345	2906	2015	60	124	R	1.677	-5.442
5792.4	257.88	.21	5.38	3327	2901	1993	60	123	R	1.705	-5.569
5766.4	259.01	.21	5.40	3309	2895	1970	60	122	R	1.734	-5.697
5740.4	259.15	.21	5.43	3291	2890	1947	59	121	R	1.764	-5.827

U U U E E E L E E E L E E E U U U E E E E

This page intentionally left blank.



Amendment 93
12/8/70

XA COORDINATES TABLE 3.4-5 (CONTINUED)
CSM 110 LEV DETAIL (TILTED) MASS PROPERTIES - PAD ABORT

DESCRIPTION	S	WEIGHT POUNDS	C. G. INCHES			INERTIAS SLUG-FT ²			PRODUCTS SLUG-FT ²		
			X	Y	Z	IXX	IYY	IZZ	PXY	PXZ	PYZ
TIME = 8.0	+	18308.0	1123.7	-.2	3.5	6479	89197	88727	302	-600	-38
9.0	+	18271.3	1123.8	-.1	3.4	6456	89054	88595	298	-568	-37
10.0	+	18244.6	1123.9	-.1	3.3	6434	88977	88530	295	-537	-37
11.0	+	18235.7	1124.0	-.1	3.3	6426	88954	88506	286	-528	-33
12.0	+	18226.8	1124.0	-.1	3.3	6418	88931	88483	277	-520	-30
13.0	+	18217.9	1124.1	-.1	3.3	6411	88907	88459	269	-512	-26
14.0	+	18217.9	1124.1	-.1	3.3	6411	88907	88459	269	-512	-26
CM W/O DOCKING MCH	+	12178.6	1040.2	-.3	4.7	5626	5020	4620	45	-347	-21
FWD HEAT SHIELD	-	310.0	1094.3	-.5	.8	64	26	23	0	0	0
CM W/O DCK.MECH,HEAT SHLD		11868.6	1038.8	-.3	4.8	5561	4792	4397	46	-332	-21
DROGUE+DISCONNECTS	-	80.8	1089.0	.0	-23.9	1	1	0	0	0	0
CM AT MAIN CHUTE DEPLOY		11787.8	1038.5	-.3	5.0	5546	4733	4353	46	-307	-21
PILOT CHUTE+MRSR	-	45.5	1089.9	5.9	-5.8	2	2	1	0	0	0
MAIN CHUTE PACKS	-	401.4	1089.1	.4	8.5	62	22	43	0	0	0
CM AT IMPACT		11340.9	1036.5	-.3	4.9	5479	4449	4051	40	-318	-20

NOTE: Delta Z = 0.80 in.

SNA-8-D-027(III)REV 2

U
N
I
T
E
D
S
T
A
T
E
S
S
P
A
C
E
A
D
M
I
N
I
S
T
R
A
T
I
O
N

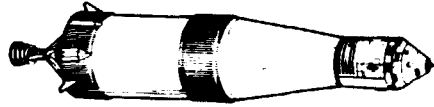

LV COORDINATES TABLE 3.4-6
SIVB EXPECTED SEQUENTIAL MASS PROPERTIES

Amendment 92
12/4/70

DESCRIPTION	S	WEIGHT POUNDS	C. G. INCHES			INERTIAS SLUG-FT ²			PRODUCTS SLUG-FT ²		
			X	Y	Z	IXX	IYY	IZZ	PXY	PXZ	PVZ
SIVB POST E.O.I.		202283.0	2834.3	1.0	-.8	89930	956807	953391			
CSM		64534.8	3691.0	4.0	6.3	34329	77237	79753			
LM (IN SLA)		33681.1	3340.9	-.3	.0	22566	24909	25022			
SIVB+CSM+LM POST E.O.I.		300498.9	3075.0	1.5	.8	147486	9388522	9387316			
SIVB PRE T.L.I.		199952.0	2831.8	1.0	-.8	89289	932724	929535			
CSM PRE T.L.I.		64527.7	3691.0	4.0	6.3	34329	77237	79753			
LM (IN SLA)		33681.1	3340.9	-.3	.0	22566	24909	25022			
SIVB+CSM+LM PRE T.L.I.		298160.8	3075.2	1.5	.8	146842	9387111	9386136			
SIVB POST T.L.I.		42238.0	2932.6	4.4	-3.7	88693	617383	613869			
CSM POST T.L.I.		64527.7	3691.0	4.0	6.3	34329	77237	79753			
LM (IN SLA)		33681.1	3340.9	-.3	.0	22566	24909	25022			
SIVB+CSM+LM POST T.L.I.		140446.8	3379.0	3.1	1.8	146280	3902601	3901245			
SIVB (EXCL. SLA PANELS)		39298.0	2901.0	4.7	-3.7	82403	456287	453154			
LM (IN SLA)		33681.1	3340.9	-.3	.0	22566	24909	25022			
SIVB+LM PRE DUCKING		72979.1	3104.0	2.4	-2.0	105121	1238981	1236008			

NOTE: Products of inertia are not presently available for the S-IVB. This table will be updated to include products of inertia when data is available.

TABLE 3.4-7

CSM 110 Consumables Weight Change Summary
(To be used in conjunction with the CSM sequential mass properties Table 3.4-2)

From	EVENT	To	Consumable	Weight Change (Pounds)	Amount Remaining (Pounds)	Total Usage (Pounds)
Earth Launch	Pre Trans/Dock		SM-Hydrogen	-0.5	54.7	-0.5
			SM-Oxygen	-11.4	819.9	-11.4
			CM-Potable	+4.0	40.0	
			CM-Waste	+0.8	18.8	
Pre Trans/Dock	Post Trans/Dock		SM-RCS	-70.6	1271.8	-70.6
Post Trans/Dock	Pre SPS Hybrid		SM-Hydrogen	-4.9	49.8	-5.4
			SM-Oxygen	-54.3	765.6	-65.7
			SM-RCS	-70.3	1201.5	-140.9
			CM-Waste H ₂ O	+41.2	60.0	
			CM-LiOH	+6.8	6.8	
			CM-Food	-3.8		-3.8
Pre SPS Hybrid	Post SPS Hybrid		SM-SPS	-724.8	39868.9	-724.8
Post SPS Hybrid	Pre L.O.I.		SM-Hydrogen	-9.4	40.4	-14.8
			SM-Oxygen	-93.9	671.7	-159.6
			SM-RCS	-65.5	1136.0	-206.4
			CM-Food	-9.4		-13.2
			CM-LiOH	+6.8	13.6	
Pre L.O.I.	Post L.O.I.		SM-SPS	-24788.7	15080.2	-25513.5
Post L.O.I.	Pre D.O.I.		SM-Hydrogen	-0.5	39.9	-15.3
			SM-Oxygen	-8.5	663.2	-168.1
			SM-RCS	-30.4	1105.6	-236.8
Pre D.O.I.	Post D.O.I.		SM-SPS	-1471.4	13608.8	-26984.9
Post D.O.I.	CSM/LM Separation		SM-Hydrogen	-3.4	36.5	-18.7
			SM-Oxygen	-31.2	632.0	-199.3
			SM-RCS	-134.0	971.6	-370.8
			CM-LiOH	+5.0	18.6	
			CM-Food	-3.8		-17.0
CSM/LM Separation	Pre Circular- ization		SM-Hydrogen	-0.3	36.2	-19.0
			SM-Oxygen	-2.0	630.0	-201.3
			SM-RCS	-26.3	945.3	-397.1
Pre Circular- ization	Post Circular- ization		SM-SPS	-272.9	13335.9	-27257.8



TABLE 3.4-7 (CONTINUED)

Amendment 92
12/4/70

CSM 110 Consumables Weight Change Summary
(To be used in conjunction with the CSM sequential mass properties Table 3.4-2)

From	EVENT	To	Consumable	Weight Change (Pounds)	Amount Remaining (Pounds)	Total Usage (Pounds)
Post Circular- ization		Pre Plane Change	SM-Hydrogen	-2.4	33.8	-21.4
			SM-Oxygen	-25.1	604.9	-226.4
			SM-RCS	-75.8	869.5	-472.9
Pre Plane Change		Post Plane Change	SM-SPS	-1269.5	12066.4	-28527.3
Post Plane Change	CSM/ASCT Docking		SM-Hydrogen	-4.9	28.9	-26.3
			SM-Oxygen	-47.4	557.5	-273.8
			SM-RCS	-135.2	734.3	-608.1
			CM-Food	-6.3		-23.3
			CM-L1OH	+7.8	26.4	
			CM-Fecal	+2.2	2.2	
CSM/ASCT Docking		Pre T.E.I.	SM-Hydrogen	-1.1	27.8	-27.4
			SM-Oxygen	-9.3	548.2	-283.1
			SM-RCS	-41.9	692.4	-650.0
			CM-Fecal	+1.1	3.3	
			CM-Food	-3.8		-27.1
			CM-L1OH	+2.6	29.0	
Pre T.E.I.		Post T.E.I.	SM-SPS	-10061.0	2005.4	-38588.3
Post T.E.I.		SM Jettison	SM-Hydrogen	-11.8	16.0	-39.2
			SM-Oxygen	-127.3	420.9	-410.4
			SM-RCS	-179.9	512.5	-829.9
			CM-L1OH	+13.4	42.4	
			CM-Food	-10.4		-37.5
			CM-Fecal	+3.3	6.6	
SM Jettison		CM @ Entry	CM-RCS	-11.6	233.4	-11.6
CM @ Entry		CM @ M.C. Deploy	CM-RCS	-30.7	202.7	-42.3
CM @ M.C. Deploy		CM @ Impact	CM-RCS	-202.7	0.0	-245.0

U U

TABLE 3.4-8

Amendment 92
12/4/70

LM-8 Consumables Change Summary

(To be used in conjunction with the LM sequential mass properties Table 3.4-2)

From	EVENT	To	Consumable	Weight Change (Pounds)	Amount Remaining (Pounds)	Total Usage (Pounds)
Earth Orbit		CSM/LM Separation	D/S-Oxygen	-1.1	46.9	-1.1
			D/S-Water	-13.0	237.0	-13.0
			LM-RCS	-5.0	600.6	-5.0
CSM/LM Separation		Pre P.D.I.	D/S-Oxygen	-1.0	45.9	-2.1
			D/S-Water	-21.3	215.7	-34.3
			LM-RCS	-55.5	545.1	-60.5
Pre P.D.I.		LM @ Touchdown	D/S-Oxygen	-0.1	45.8	-2.2
			D/S-Water	-1.1	214.6	-35.4
			LM-RCS	-97.0	448.1	-157.5
			LM-DPS	-17,342.6	977.1	-17,342.6
A/S @ Touchdown	A/S at Lift-Off		LM-RCS	-5.0	443.1	-162.5
A/S @ Lift-Off	A/S in Orbit		LM-APS	-4,927.8	282.8	-4,927.8
A/S in Orbit		Pre T.P.I.	A/S-Water	-5.0	80.0	-5.0
			A/S-Oxygen	-0.3	4.5	-0.3
			LM-RCS	-47.4	395.7	209.9
Pre T.P.I.	Post T.P.I.		LM-APS	-39.0	243.8	-4,966.8
A/S @ Post T.P.I.	A/S @ Docking		A/S-Water	-3.8	76.2	-8.8
			A/S-Oxygen	-0.2	4.3	-0.5
			LM-RCS	70.2	325.5	-280.1
A/S @ Docking	A/S Jettison		A/S-Water	-8.2	68.0	-17.0
			A/S-Oxygen	-0.4	3.9	-0.9

MISSION H3 TRANSFERABLE EQUIPMENT

Amendment 88
10/5/70

REFERENCE CODE EXPLANATION

The reference table used with this Transferable Equipment List is a directory of information sources from which data for each item were obtained. It is intended to define the exact source for each portion of the data used. This reference table is correlated to each item in the Transferable Equipment List by a 3-digit reference code number.

The code is the form

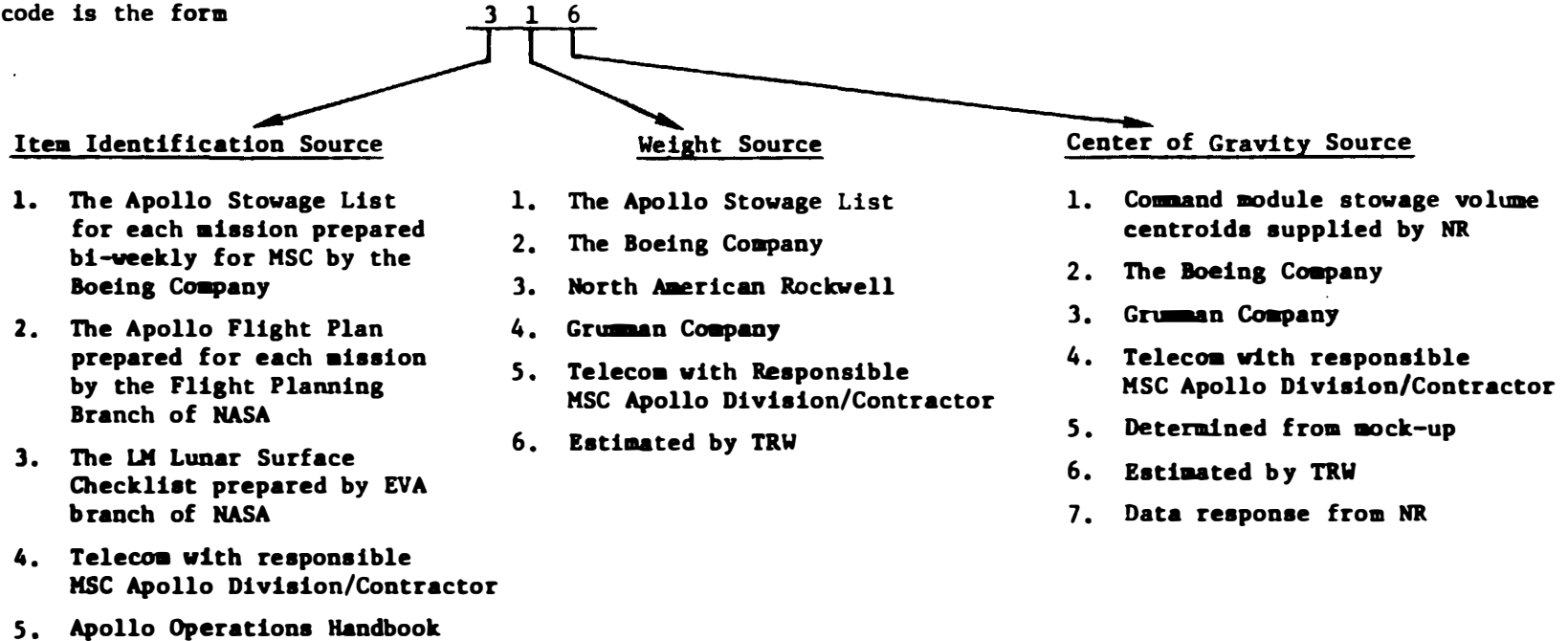

TABLE 3.4-9
MISSION H COMMAND MODULE STOWAGE VOLUME CENTROIDS
S/C 109 - 111

<u>AREA</u>	<u>X</u>	<u>Y</u>	<u>Z</u>
A1	1012.0	-22.0	-26.0
3	1016.0	-24.0	28.0
4	1015.0	- 7.0	28.0
5	1015.0	9.0	28.0
6	1017.0	26.0	28.0
7 - Not on S/C 110	1012.0	31.0	7.0
8	1012.0	22.0	-23.0
10 - S/C 110 Only	1011.0	23.0	6.0
11 - Not on S/C 110	1011.0	19.0	7.0
12	1013.0	- 9.0	14.0
13	1010.0	-22.0	- 2.0
B1	1050.0	-27.0	39.0
2	1039.0	-38.0	37.0
3	1031.0	-28.0	40.0
4	1031.0	-20.0	40.0
5	1031.0	- 8.0	39.0
6	1031.0	13.0	39.0
7	1033.0	27.0	36.0
8	1024.0	-38.0	37.0
L2	1059.0	-44.0	14.0
3	1048.0	-47.0	12.0
R1	1072.0	26.0	21.0
2	1072.0	26.0	14.0
3	1072.0	26.0	9.0
4	1075.0	28.0	3.0
5	1059.0	44.0	15.0
6	1048.0	46.0	29.0
8	1052.0	46.0	12.0
10 - Forward	1053.0	47.0	5.0
10 - Aft	1047.0	48.0	5.0
11	1038.0	47.0	26.0
13	1024.0	45.0	-26.0
U1	1033.0	23.0	-50.0
3	1033.0	-36.0	-44.0
4	1038.0	39.0	-43.0



Table 3.4-9.1

The following stowage locations have unique volume centroids not associated with stowage volumes.

<u>NOMENCLATURE</u>	<u>LOCATION</u>	<u>X</u>	<u>Y</u>	<u>Z</u>
G&N Signal Cond. Panel	LEB	1069.0	25.0	29.0
Display Keyboard	LEB	1060.0	26.0	32.0
Sleep Restraint Assy - Right	Aft UEB	1018.0	25.0	-47.9
Sleep Restraint Assy - Left	Aft UEB	1018.0	-21.0	-49.9
Food Container	L3	1048.0	-47.0	12.0
Food Container	B1	1050.0	-27.0	39.0
Meal Stowage Container	RHEB	1039.0	47.0	12.0
PGA Container	On Aft Bulkhead Under Center Couch	1015.0	0.0	-19.9
Forward Hatch Container	Under L.H. Couch	1018.0	-24.5	-15.0
Container, R12 (In-flight Location)	R.H. Girth Ring	1036.5	40.0	-25.0
Helmet Stowage and Accessory Bag (In-flight Location) - L.H.	L.H. Girth Ring	1036.5	-40.0	-25.0
Helmet Stowage and Accessory Bags (In-flight Location) - Ctr.	LEB	1050.0	-27.0	39.0
Helmet Stowage and Accessory Bags (In-flight Location) - R.H.	R.H. Girth Ring	1036.5	40.0	-25.0
Temporary Stowage Bag - L.H. (In-flight Location)	LHEB	1039.0	-47.0	12.0
Temporary Stowage Bag - Ctr. (In-flight Location)	LEB	1050.0	-27.0	39.0
Temporary Stowage Bag - R.H. (In-flight Location)	RHEB	1039.0	47.0	12.0
CO ₂ Absorbers (2)	In ECU	1031.0	-48.3	19.6
CO ₂ Absorbers (4)	A3	1016.0	-24.0	28.0
CO ₂ Absorbers (4)	A4	1015.0	-7.0	28.0
CO ₂ Absorbers (2)	A6	1017.0	26.0	28.0
CO ₂ Absorbers (4)	B5	1031.0	-8.0	39.0
CO ₂ Absorbers (4)	B6	1031.0	13.0	39.0
	Composite Location used in Sequential Mass Properties Tables For CO ₂ Absorbed.			
First 6.8 lb. CO ₂ Absorbed	B5	1031.0	-8.0	39.0
Next 6.8 lb. CO ₂ Absorbed	B6	1031.0	13.0	39.0
Remainder CO ₂ Absorbed	Composite Location	1018.5	-14.3	26.1



Table 3.4-9.2

MISSION H-3 TRANSFERRED CREW AND EQUIPMENT STOWAGE LIST								
ITEMS REARRANGED IN CM PRIOR TO FIRST MID-COURSE CORRECTION (1)								
APOLLO COORDINATES								
DESCRIPTION	STOW. ITEM	REF	NO.	STOWAGE LOCATION	WEIGHT	X-C.G.	Y-C.G.	Z-C.G.
CREW-COMMAND MODULE PILOT(CMP)	T3D	227	1	ON COUCH(CTR CREW STA	161.0	1043.0	.0	-10.4
CREW-COMMANDER (CDR)	T3D	227	1	ON COUCH(CTR CREW STA	171.0	1043.0	-24.5	-10.4
TORSO+LIMB SUIT ASSY, IV-CMP.	B0201.1	127	1	ON CREW-CMP(CTR STA)	30.5	1043.0	.0	-10.4
HELMET ASSY,PRESSURE-CMP.	B0201.2	127	1	ON CREW-CMP(CTR STA)	2.5	1043.0	.0	-10.4
GLOVES, IV(PAIR)-CMP.	B0201.3	127	1	ON CREW-CMP(CTR STA)	1.7	1043.0	.0	-10.4
COMMUNICATIONS CARRIER-CMP.	B0201.4	127	1	ON CREW-CMP(CTR STA)	1.6	1043.0	.0	-10.4
POCKET,CHECKLIST+SCISSORS-CMP.	B0201.5	167	1	ON CREW-CMP(CTR STA)	.2	1043.0	.0	-10.4
POCKET, CHECKLIST-CMP	B0201.6	167	1	ON CREW-CMP(CTR STA)	.2	1043.0	.0	-10.4
VEST,DUAL LIFE-CMP.	B0202.	111	1	ON CREW-CMP(CTR STA)	2.4	1043.0	.0	-10.4
BAG, MOTION SICKNESS-CMP.	A0208.	111	1	ON PGA(CREW-CTR STA)	.1	1043.0	.0	-10.4
UCTA-CMP.	B0205.	117	1	ON CREW-CMP(CTR STA)	.5	1043.0	.0	-10.4
T-ADAPTER,CWG-CMP.	B0135.	111	1	IN ADAPTER BAG (AB)	.4	1012.0	22.0	-23.0
JACKET ASSY, ICG-CMP.	B0112.1	111	1	IN CM PGA CONTAINER	1.8	1015.0	.0	-19.9
TROUSER ASSY, ICG-CMP.	B0112.2	111	1	IN CM PGA CONTAINER	1.8	1015.0	.0	-19.9
BOOT, RIGHT, ICG-CMP.	B0112.3	111	1	IN CM PGA CONTAINER	.4	1015.0	.0	-19.9
BOOT, LEFT, ICG-CMP.	B0112.4	111	1	IN CM PGA CONTAINER	.4	1015.0	.0	-19.9
EARTUBE, UNIVERSAL-CMP.	E0105.1	111	1	ON ICG(PGA CONTAINER)	NEGL	1015.0	.0	-19.9
BIOINSTRUMENTATION-CMP.	B0203.	111	1	ON CREW-CMP(CTR STA)	1.1	1043.0	.0	-10.4
HEADSET, LIGHTWEIGHT-CMP.	E0104.	111	1	AREA AB	.4	1012.0	22.0	-23.0
TORSO+LIMB SUIT ASSY, EV-CDR.	B0200.1	127	1	ON CREW-CDR(LH STA)	39.3	1043.0	-24.5	-10.4
HELMET ASSY,PRESSURE-CDR.	B0200.2	127	1	ON CREW-CDR(LH STA)	2.5	1043.0	-24.5	-10.4
GLOVES, IV(PAIR)-CDR.	B0200.3	127	1	ON CREW-CDR(LH STA)	1.7	1043.0	-24.5	-10.4
COMMUNICATION CARRIER-CDR.	B0200.4	127	1	ON CREW-CDR(LH STA)	1.6	1043.0	-24.5	-10.4
POCKET,CHECKLIST+SCISSORS-CDR.	B0200.5	167	1	ON CREW-CDR(LH STA)	.2	1043.0	-24.5	-10.4
POCKET,CHECKLIST-CDR.	B0200.6	167	1	ON CREW-CDR(LH STA)	.2	1043.0	-24.5	-10.4
VEST,DUAL LIFE-CDR.	B0202.	111	1	ON CREW-CDR(LH STA)	2.4	1043.0	-24.5	-10.4
BAG, MOTION SICKNESS-CDR.	A0208.	111	1	ON PGA (CREW-LH STA)	.1	1043.0	-24.5	-10.4
UCTA-CDR.	B0205.	117	1	ON CREW-CDR(LH STA)	.5	1043.0	-24.5	-10.4
T-ADAPTER,CWG-CDR.	B0135.	111	1	IN ADAPTER BAG (AB)	.4	1012.0	22.0	-23.0
JACKET ASSY, ICG-CDR.	B0112.1	111	1	IN CM PGA CONTAINER	1.8	1015.0	.0	-19.9
TROUSER ASSY, ICG-CDR.	B0112.2	111	1	IN CM PGA CONTAINER	1.8	1015.0	.0	-19.9
BOOT, RIGHT, ICG-CDR.	B0112.3	111	1	IN CM PGA CONTAINER	.4	1015.0	.0	-19.9

NOTE: Further information relating to this table is given on pages 3.4-19, 3.4-20 and 3.4-21.

Table 3.4-9.2 (Continued)

MISSION H-3 TRANSFERRED CREW AND EQUIPMENT STORAGE LIST								
ITEMS REARRANGED IN CM PRIOR TO FIRST MID-COURSE CORRECTION (1)							APOLLO COORDINATES	
DESCRIPTION	STOW. ITEM	REF	NO.	STORAGE LOCATION	WEIGHT	X-C.G.	Y-C.G.	Z-C.G.
BOOT, LEFT, ICG-CDR.	B0112.4	111	1	IN CM PGA CONTAINER	.4	1015.0	.0	-19.9
EARTUBE, UNIVERSAL-CDR.	E0105.	111	1	ON ICG (PGA CONTAINER)	NEGL	1015.0	.0	-19.9
BIOINSTRUMENTATION-CDR.	B0203.	111	1	ON CREW-CDR (LH STA)	1.1	1043.0	-24.5	-10.4
HEADSET, LIGHTWEIGHT-CDR.	E0104.	111	1	AREA A8	.4	1012.0	22.0	-23.0
EARPIECE, MOLDED (COM. CARR)-CDR.	E0200.1	111	1	ON CREW-CDR (LH STA)	NEGL	1043.0	-24.5	-10.4
EARTUBE (COM. CARRIER)-CDR.	E0200.2	111	1	ON CREW-CDR (LH STA)	NEGL	1043.0	-24.5	-10.4
TORSO+LIMB SUIT ASSY, EV-LMP.	B0200.1	127	1	ON CREW-LMP (RH STA)	39.3	1043.0	24.5	-10.4
HELMET ASSY, PRESSURE-LMP.	B0200.2	127	1	ON CREW-LMP (RH STA)	2.5	1043.0	24.5	-10.4
GLOVES, IV (PAIR)-LMP.	B0200.7	127	1	ON CREW-LMP (RH STA)	1.6	1043.0	24.5	-10.4
COMMUNICATIONS CARRIER-LMP.	B0200.4	127	1	ON CREW-LMP (RH STA)	1.6	1043.0	24.5	-10.4
POCKET, CHECKLIST+SCISSORS-LMP.	B0200.5	167	1	ON CREW-LMP (RH STA)	.2	1043.0	24.5	-10.4
POCKET, CHECKLIST-LMP.	B0200.6	167	1	ON CREW-LMP (RH STA)	.2	1043.0	24.5	-10.4
VEST, DUAL LIFE-LMP.	B0202.	111	1	ON CREW-LMP (RH STA)	2.4	1043.0	24.5	-10.4
BAG, MOTION SICKNESS-LMP.	A0208.	111	1	ON PGA (CREW-RH STA)	.1	1043.0	24.5	-10.4
UCTA-LMP.	B0205.	117	1	ON CREW-LMP (RH STA)	.5	1043.0	24.5	-10.4
T-ADAPTER, CWG-LMP.	B0135.	111	1	IN ADAPTER BAG (A8)	.4	1012.0	22.0	-23.0
JACKET ASSY, ICG-LMP.	B0112.1	111	1	IN CM PGA CONTAINER	1.8	1015.0	.0	-19.9
TROUSER ASSY, ICG-LMP.	B0112.2	111	1	IN CM PGA CONTAINER	1.8	1015.0	.0	-19.9
BOOT, RIGHT, ICG-L 4P.	B0112.3	111	1	IN CM PGA CONTAINER	.4	1015.0	.0	-19.9
BOOT, LEFT, ICG-LMP.	B0112.4	111	1	IN CM PGA CONTAINER	.4	1015.0	.0	-19.9
EARTUBE, UNIVERSAL-LMP.	E0105.	111	1	ON ICG (PGA CONTAINER)	NEGL	1015.0	.0	-19.9
HEADSET, LIGHTWEIGHT-LMP.	E0104.	111	1	AREA A9	.4	1012.0	22.0	-23.0
EARPIECE, MOLDED (COM. CARR.)-LMP.	E0200.1	111	1	ON CREW-LMP (RH STA)	NEGL	1043.0	24.5	-10.4
EARTUBE (COMM. CARRIER)-LMP.	E0200.2	111	1	ON CREW-LMP (RH STA)	NEGL	1043.0	24.5	-10.4
BAG, HELMET STOW, INFLIGHT-CMP.	B0105.	115	1	AREA R6	.6	1048.0	46.0	29.0
BAG, HELMET STOW, INFLIGHT-CDR.	B0105.	115	1	AREA R6	.6	1048.0	46.0	29.0
BAG, HELMET STOW, INFLIGHT-LMP.	B0105.	115	1	AREA R6	.6	1048.0	46.0	29.0
BAG, ACCESSORY-CMP.	B0105.1	115	1	HELMET STOW. BAG (R6)	.3	1048.0	46.0	29.0
BAG, ACCESSORY-CDR.	B0105.1	115	1	HELMET STOW. BAG (R6)	.3	1048.0	46.0	29.0
BAG, ACCESSORY-LMP.	B0105.1	115	1	HELMET STOW. BAG (R6)	.3	1048.0	46.0	29.0
CONTAINER, TEMP. STOW-CMP.	U0301.	115	1	AREA A1	1.7	1012.0	-22.0	-26.0
CONTAINER, TEMP. STOW-CUR.	U0301.	115	1	AREA A1	1.7	1012.0	-22.0	-26.0

NOTE: Further information relating to this table is given on pages 3.4-19, 3.4-20 and 3.4-21.

Table 3.4-9.2 (Continued)

MISSION H-3 TRANSFERRED CREW AND EQUIPMENT STOWAGE LIST								
ITEMS REARRANGED IN CM PRIOR TO FIRST MID-COURSE CORRECTION (1)								
APOLLO COORDINATES								
DESCRIPTION	STOW. ITEM	REF	NO.	STOWAGE LOCATION	WEIGHT	X-C.G.	Y-C.G.	Z-C.G.
CONTAINER, TEMP. STEW-LMP.	U0301.	115	1	AREA A1	1.7	1012.0	-22.0	-26.0
CONTAINER, R12	U0344	115	1	AREA R3	2.7	1072.0	26.0	9.0
CSM LAUNCH CHECKLIST	A0114.1	164	2	IN FDF (R12/IN R3)	1.0	1072.0	26.0	9.0
CSM G/C CHECKLIST	A0114.2	164	1	IN FDF (R12/IN R3)	1.0	1072.0	26.0	9.0
CSM SYSTEM CHECKLIST	A0114.3	164	1	IN FDF (R12/IN R3)	1.0	1072.0	26.0	9.0
CSM LUNAR LANDMARK MAP	A0114.5	164	1	IN FDF (R12/IN R3)	.6	1072.0	26.0	9.0
CSM DATA SYSTEMS	A0114.7	164	1	IN FDF (R12/IN R3)	.9	1072.0	26.0	9.0
CSM MALFUNCTIONS PROCEDURES	A0114.8	164	1	IN FDF (R12/IN R3)	.6	1072.0	26.0	9.0
FLIGHT PLAN	A0114.9	164	1	IN FDF (R12/IN R3)	3.0	1072.0	26.0	9.0
CMF SLOU BOOK	A0114.11	164	1	IN FDF (R12/IN R3)	.9	1072.0	26.0	9.0
RESCUE BOOK	A0114.15	164	1	IN FDF (R12/IN R3)	.9	1072.0	26.0	9.0
PANEL IND.-VERB/NOUN LIST	H0104.	115	1	GNIC PANEL	.2	1050.0	.0	22.0
SLEEP RESTRAINT ASSY-LH	U3022.	117	1	AFT UPR EQUIP. BAY-LH	3.7	1018.0	-21.9	-49.9
SLEEP RESTRAINT ASSY-RH	U3023.	117	1	AFT UPR EQUIP. BAY-RH	3.7	1018.0	25.0	-47.9
CM EQUIP. RELOC.1					514.40	1042.21	-7.42	-10.72

NOTE: Further information relating to this table is given on pages 3.4-19, 3.4-20 and 3.4-21.

Table 3.4-9.2 (Continued)

MISSION H-3 TRANSFERRED CREW AND EQUIPMENT STORAGE LIST								
ITEMS REARRANGED IN CM PRIOR TO FIRST MID-COURSE CORRECTION (2)								
APOLLO COORDINATES								
DESCRIPTION	STOW. ITEM	REF	NO.	STOWAGE LOCATION	WEIGHT	X-C.G.	Y-C.G.	Z-C.G.
CREW-COMMAND MODULE PILOT(CMP)	T&D	227	1	ON COUCH(LH CREW STA	161.0	1043.0	-24.5	-10.4
CREW-COMMANDER (CDR)	T&D	227	1	ON COUCH(CTR CRW. STA	171.0	1043.0	.0	-10.4
TORSO+LIMB SUIT ASSY, IV-CMP.	80201.1	127	1	IN CM PGA CONTAINER	30.5	1015.0	.0	-19.9
HELMET ASSY, PRESSURE-CMP.	80201.2	127	1	IN CMP HSB-LH BHD	2.5	1043.0	-22.0	-55.0
GLOVES, IV(PAIR)-CMP.	80201.3	127	1	IN ACCES. BAG(HSB/CMP	1.7	1043.0	-22.0	-55.5
COMMUNICATIONS CARRIER-CMP.	80201.4	127	1	IN ACCES. BAG(HSB/CMP	1.6	1043.0	-22.0	-55.5
POCKET, CHECKLIST+SCISSORS-CMP.	80201.5	167	1	ON ICG-CMP./LH STA.	.2	1043.0	-24.5	-10.4
POCKET, CHECKLIST-CMP	80201.6	167	1	ON ICG-CMP./LH STA.	.2	1043.0	-24.5	-10.4
VEST, DUAL LIFE-CMP.	80202.	111	1	IN ACCES. BAG(HSB/CMP	2.4	1043.0	-22.0	-55.5
BAG, MOTION SICKNESS-CMP.	A0208.	111	1	ON PGA(PGA CONTAINR)	.1	1015.0	.0	-19.9
UCTA-CMP.	80205.	117	1	ON PGA(PGA CONTAINR)	.5	1015.0	.0	-19.9
T-ADAPTER, CWG-CMP.	80135.	111	1	ON CREW-CMP(LH STA)	.4	1043.0	-24.5	-10.4
JACKET ASSY, ICG-CMP.	80112.1	111	1	ON CREW-CMP(LH STA)	1.8	1043.0	-24.5	-10.4
TROUSER ASSY, ICG-CMP.	80112.2	111	1	ON CREW-CMP(LH STA)	1.8	1043.0	-24.5	-10.4
BOOT, RIGHT, ICG-CMP.	80112.3	111	1	ON CREW-CMP(LH STA)	.4	1043.0	-24.5	-10.4
BOOT, LEFT, ICG-CMP.	80112.4	111	1	ON CREW-CMP(LH STA)	.4	1043.0	-24.5	-10.4
EARTUBE, UNIVERSAL-CMP.	E0105.1	111	1	ON ICG-CMP./LH STA.	NEGL	1043.0	-24.5	-10.4
BIOINSTRUMENTATION-CMP.	80203.	111	1	ON CREW-CMP(LH STA)	1.1	1043.0	-24.5	-10.4
HEADSET, LIGHTWEIGHT-CMP.	E0104.	111	1	ON CREW-CMP(LH STA)	.4	1043.0	-24.5	-10.4
TORSO+LIMB SUIT ASSY, EV-CDR.	80200.1	127	1	IN CM PGA CONTAINER	39.3	1015.0	.0	-19.9
HELMET ASSY, PRESSURE-CDR.	80200.2	127	1	IN CDR HSB-LH LEB	2.5	1048.0	-30.0	34.0
GLOVES, IV(PAIR)-CDR.	80200.3	127	1	IN ACCES. BAG(HSB/CDR	1.7	1048.0	-30.0	34.0
COMMUNICATION CARRIER-CDR.	80200.4	127	1	IN ACCES. BAG(HSB/CDR	1.6	1048.0	-30.0	34.0
POCKET, CHECKLIST+SCISSORS-CDR.	80200.5	167	1	ON ICG-CTR./CTR. STA.	.2	1043.0	.0	-10.4
POCKET, CHECKLIST-CDR.	80200.6	167	1	ON ICG-CTR./CTR. STA.	.2	1043.0	.0	-10.4
VEST, DUAL LIFE-CDR.	80202.	111	1	IN ACCES. BAG(HSB/CDR	2.4	1048.0	-30.0	34.0
BAG, MOTION SICKNESS-CDR.	A0208.	111	1	ON PGA(PGA CONTAINR)	.1	1015.0	.0	-19.9
UCTA-CDR.	80205.	117	1	IN CM PGA CONTAINER	.5	1015.0	.0	-19.9
T-ADAPTER, CWG-CDR.	80135.	111	1	ON CREW-CDR(CTR. STA)	.4	1043.0	.0	-10.4
JACKET ASSY, ICG-CDR.	80112.1	111	1	ON CREW-CDR(CTR. STA)	1.8	1043.0	.0	-10.4
TROUSER ASSY, ICG-CDR.	80112.2	111	1	ON CREW-CDR(CTR. STA)	1.8	1043.0	.0	-10.4
BOOT, RIGHT, ICG-CDR.	80112.3	111	1	ON CREW-CDR(CTR. STA)	.4	1043.0	.0	-10.4

NOTE: Further information relating to this table is given on pages 3.4-19, 3.4-20 and 3.4-21.

Table 3.4-9.2 (Continued)

MISSION H-3 TRANSFERRED CREW AND EQUIPMENT STOWAGE LIST								
ITEMS REARRANGED IN CM PRIOR TO FIRST MID-COURSE CORRECTION (2)								
APULLO COORDINATES								
DESCRIPTION	STOW. ITEM	REF	NO.	STOWAGE LOCATION	WEIGHT	X-C.G.	Y-C.G.	Z-C.G.
BOOT, LEFT, ICG-CDR.	B0112.4	111	1	ON CREW-CDR(CTR.STA)	.4	1043.0	.0	-10.4
EARTUBE, UNIVERSAL-CDR.	E0105.	111	1	ON ICG-CDR./CTR.STA.	NEGL	1043.0	.0	-10.4
BIDINSTRUMENTATION-CDR.	B0203.	111	1	ON CREW-CDR(CTR.STA)	1.1	1043.0	.0	-10.4
HEADSET, LIGHTWEIGHT-CDR.	E0104.	111	1	ON CREW-CDR(CTR.STA)	.4	1043.0	.0	-10.4
EARPIECE, MOLDED(COM.CARR)-CDR.	E0200.1	111	1	IN ACCES.BAG(HSB/CDR	NEGL	1048.0	-30.0	34.0
EARTUBE(COM.CARRIER)-CDR.	E0200.2	111	1	IN ACCES.BAG(HSB/CDR	NEGL	1048.0	-30.0	34.0
TORSO+LIMB SUIT ASSY, EV-LMP.	B0200.1	127	1	IN CM PGA CONTAINER	39.3	1015.0	.0	-19.9
HELMET ASSY, PRESSURE-LMP.	B0200.2	127	1	IN LMP HSB-RH BHD	2.5	1034.0	22.0	-55.0
GLOVES, IV(PAIR)-LMP.	B0200.7	127	1	IN ACCES.BAG(HSB/LMP	1.6	1034.0	22.0	-55.0
COMMUNICATIONS CARRIER-LMP.	B0200.4	127	1	IN ACCES.BAG(HSB/LMP	1.6	1034.0	22.0	-55.0
POCKET, CHECKLIST+SCISSORS-LMP.	B0200.5	167	1	ON ICG-LMP./RH STA.	.2	1043.0	24.5	-10.4
POCKET, CHECKLIST-LMP.	B0200.6	167	1	ON ICG-LMP./RH STA.	.2	1043.0	24.5	-10.4
VEST, DUAL LIFE-LMP.	B0202.	111	1	IN ACCES.BAG(HSB/LMP	2.4	1034.0	22.0	-55.0
BAG, MOTION SICKNESS-LMP.	A0208.	111	1	ON PGA(PGA CONTAINER)	.1	1015.0	.0	-19.9
UCTA-LMP.	B0205.	117	1	IN CM PGA CONTAINER	.5	1015.0	.0	-19.9
T-ADAPTER, CWG-LMP.	B0135.	111	1	ON CREW-LMP(RH STA)	.4	1043.0	24.5	-10.4
JACKET ASSY, ICG-LMP.	B0112.1	111	1	ON CREW-LMP(RH STA)	1.8	1043.0	24.5	-10.4
TROUSER ASSY, ICG-LMP.	B0112.2	111	1	ON CREW-LMP(RH STA)	1.8	1043.0	24.5	-10.4
BOOT, RIGHT, ICG-LMP.	B0112.3	111	1	ON CREW-LMP(RH STA)	.4	1043.0	24.5	-10.4
BOOT, LEFT, ICG-LMP.	B0112.4	111	1	ON CREW-LMP(RH STA)	.4	1043.0	24.5	-10.4
EARTUBE, UNIVERSAL-LMP.	E0105.	111	1	ON ICG-LMP./RH STA.	NEGL	1043.0	24.5	-10.4
HEADSET, LIGHTWEIGHT-LMP.	E0104.	111	1	ON CREW-LMP(RH STA)	.4	1043.0	24.5	-10.4
EARPIECE, MOLDED(COM.CARR.)LMP.	E0200.1	111	1	IN ACCES.BAG(HSB/LMP	NEGL	1034.0	22.0	-55.0
EARTUBE(LUMP.CARRIER)-LMP.	E0200.2	111	1	IN ACCES.BAG(HSB/LMP	NEGL	1034.0	22.0	-55.0
BAG, HELMET STOW, INFLIGHT-CMP.	B0105.	115	1	LH BHD-HSB/CMP	.6	1043.0	-22.0	-55.0
BAG, HELMET STOW, INFLIGHT-CDR.	B0105.	115	1	LH LEB-HSB/CDR	.6	1048.0	-30.0	34.0
BAG, HELMET STOW, INFLIGHT-LMP.	B0105.	115	1	RH BHD-HSB/LMP	.6	1034.0	22.0	-55.0
BAG, ACCESSORY-CMP.	B0105.1	115	1	IN CMP HSB-LH BHD	.3	1043.0	-22.0	-55.0
BAG, ACCESSORY-CDR.	B0105.1	115	1	IN CDR HSB-LH LEB	.3	1048.0	-30.0	34.0
BAG, ACCESSORY-LMP.	B0105.1	115	1	IN LMP HSB-RH BHD	.3	1034.0	22.0	-55.0
CONTAINER, TEMP.STOW-CMP.	B0301.	115	1	RH LEB-TSB	1.7	1039.5	33.5	34.0
CONTAINER, TEMP.STOW-CDR.	B0301.	115	1	LH BIRTH RING/TSB	1.7	1028.0	-45.0	-28.0

NOTE: Further information relating to this table is given on pages 3.4-19, 3.4-20 and 3.4-21.

Table 3.4-9.2 (Continued)

MISSION H-3 TRANSFERRED CREW AND EQUIPMENT STOWAGE LIST								
ITEMS REARRANGED IN CM PRIOR TO FIRST MID-COURSE CORRECTION (2)						APOLLO COORDINATES		
DESCRIPTION	STOW. ITEM	REF	NO.	STOWAGE LOCATION	WEIGHT	X-C.G.	Y-C.G.	Z-C.G.
CONTAINER, TEMP. STOW-LFP.	00301.	115	1	RF 31WTH RING-TSB	1.7	1030.0	36.0	-43.0
CONTAINER #12	00344	115	1	CONT. R12 (RH GRTH. RNG)	2.7	1034.0	41.0	-21.0
CSM LAUNCH CHECKLIST	A0114.1	164	2	FDF (R12/RH GRTH. RNG)	1.0	1034.0	41.0	-21.0
CSM G/C CHECKLIST	A0114.2	164	1	FDF (R12/RH GRTH. RNG)	1.0	1034.0	41.0	-21.0
CSM SYSTEM CHECKLIST	A0114.3	164	1	FDF (R12/RH GRTH. RNG)	1.0	1034.0	41.0	-21.0
CSM LUNAR LANDMARK MAP	A0114.5	164	1	FDF (R12/RH GRTH. RNG)	.6	1034.0	41.0	-21.0
CSM DATA SYSTEMS	A0114.7	164	1	FDF (R12/RH GRTH. RNG)	.9	1034.0	41.0	-21.0
CSM MALFUNCTIONS PRECEDEURES	A0114.8	164	1	FDF (R12/RH GRTH. RNG)	.6	1034.0	41.0	-21.0
FLIGHT PLAN	A0114.9	164	1	FDF (R12/RH GRTH. RNG)	3.0	1034.0	41.0	-21.0
OMP SELC BOOK	A0114.11	164	1	FDF (R12/RH GRTH. RNG)	.9	1034.0	41.0	-21.0
RESCUE BOOK	A0114.15	164	1	FDF (R12/RH GRTH. RNG)	.9	1034.0	41.0	-21.0
PANEL IND.-VEP/H/NOV LIST	H0104.	115	1	DATA CARD KIF (R3)	.2	1072.0	26.0	9.0
SLEEP RESTRAINT ASSY-LH	03022.	117	1	UNDER LH COUCH	3.7	1018.0	-24.5	-15.0
SLEEP RESTRAINT ASSY-RH	03023.	117	1	UNDER RH COUCH	3.7	1018.0	24.5	-15.0
CM EQUIP. PFLCG.1					514.40	1036.22	-7.16	-13.57

NOTE: Further information relating to this table is given on pages 3.4-19, 3.4-20 and 3.4-21.

Table 3.4-9.2 (Continued)

MISSION H-3 TRANSFERRED CREW AND EQUIPMENT STORAGE LIST								
ITEMS REARRANGED IN CM PRIOR TO LM ACTIVATION (3)								
APOLLO COORDINATES								
DESCRIPTION	STOW. ITEM	REF	NO.	STORAGE LOCATION	WEIGHT	X-C.G.	Y-C.G.	Z-C.G.
TORSO+LIMB SUIT ASSY, IV-CMP.	B0201.1	127	1	IN CM PGA CONTAINER	30.5	1015.0	.0	-19.9
HELMET ASSY, PRESSURE-CMP.	B0201.2	127	1	IN CMP HSB-LH BHD	2.5	1043.0	-22.0	-55.0
GLOVES, IV (PAIR)-CMP.	B0201.3	127	1	IN ACCES. BAG (HSB/CMP)	1.7	1043.0	-22.0	-55.5
COMMUNICATIONS CARRIER-CMP.	B0201.4	127	1	IN ACCES. BAG (HSB/CMP)	1.6	1043.0	-22.0	-55.5
POCKET, CHECKLIST+SCISSORS-CMP.	B0201.5	167	1	ON ICG-CMP./LH STA.	.2	1043.0	-24.5	-10.4
POCKET, CHECKLIST-CMP.	B0201.6	167	1	ON ICG-CMP./LH STA.	.2	1043.0	-24.5	-10.4
BAG, MITTUN SICKNESS-CMP.	A0208.	111	1	ON PGA (PGA CONTAINER)	.1	1015.0	.0	-19.9
UCTA-CMP.	B0205.	117	1	ON PGA (PGA CONTAINER)	.5	1015.0	.0	-19.9
T-ADAPTER, CWG-CMP.	B0135.	111	1	ON CREW-CMP (LH STA)	.4	1043.0	-24.5	-10.4
JACKET ASSY, ICG-CMP.	B0112.1	111	1	ON CREW-CMP (LH STA)	1.8	1043.0	-24.5	-10.4
TROUSER ASSY, ICG-CMP.	B0112.2	111	1	ON CREW-CMP (LH STA)	1.8	1043.0	-24.5	-10.4
BOOT, RIGHT, ICG-CMP.	B0112.3	111	1	ON CREW-CMP (LH STA)	.4	1043.0	-24.5	-10.4
BOOT, LEFT, ICG-CMP.	B0112.4	111	1	ON CREW-CMP (LH STA)	.4	1043.0	-24.5	-10.4
EARTUBE, UNIVERSAL-CMP.	E0105.1	111	1	ON ICG-CMP./LH STA.	NEGL	1043.0	-24.5	-10.4
HEADSET, LIGHTWEIGHT-CMP.	E0104.	111	1	ON CREW-CMP (LH STA)	.4	1043.0	-24.5	-10.4
SUBSYSTEM, FECAL CONTAINMENT-CMP	B0113.	117	1	AREA UI	.3	1033.0	23.0	-50.0
TORSO+LIMB SUIT ASSY, EV-CDR.	B0200.1	127	1	IN CM PGA CONTAINER	39.3	1015.0	.0	-19.9
HELMET ASSY, PRESSURE-CDR.	B0200.2	127	1	IN CDR HSB-LH LEB	2.5	1048.0	-30.0	34.0
GLOVES, IV (PAIR)-CDR.	B0200.3	127	1	IN ACCES. BAG (HSB/CDR)	1.7	1048.0	-30.0	34.0
COMMUNICATION CARRIER-CDR.	B0200.4	127	1	IN ACCES. BAG (HSB/CDR)	1.6	1048.0	-30.0	34.0
POCKET, CHECKLIST+SCISSORS-CDR.	B0200.5	167	1	ON ICG-CDR./CTR. STA.	.2	1043.0	.0	-10.4
POCKET, CHECKLIST-CDR.	B0200.6	167	1	ON ICG-CDR./CTR. STA.	.2	1043.0	.0	-10.4
UCTA-CDR.	B0205.	117	1	IN CM PGA CONTAINER	.5	1015.0	.0	-19.9
T-ADAPTER, CWG-CDR.	B0135.	111	1	ON CREW-CDR (CTR. STA)	.4	1043.0	.0	-10.4
JACKET ASSY, ICG-CDR.	B0112.1	111	1	ON CREW-CDR (CTR. STA)	1.8	1043.0	.0	-10.4
TROUSER ASSY, ICG-CDR.	B0112.2	111	1	ON CREW-CDR (CTR. STA)	1.8	1043.0	.0	-10.4
BOOT, RIGHT, ICG-CDR.	B0112.3	111	1	ON CREW-CDR (CTR. STA)	.4	1043.0	.0	-10.4
BOOT, LEFT, ICG-CDR.	B0112.4	111	1	ON CREW-CDR (CTR. STA)	.4	1043.0	.0	-10.4
EARTUBE, UNIVERSAL-CDR.	E0105.	111	1	ON ICG-CDR./CTR. STA.	NEGL	1043.0	.0	-10.4
HEADSET, LIGHTWEIGHT-CDR.	E0104.	111	1	ON CREW-CDR (CTR. STA)	.4	1043.0	.0	-10.4
GARMENT, CONSTANT WEAR-CDR.	B0209.	111	1	ON CREW-CDR (CTR. STA)	.8	1043.0	.0	-10.4
GARMENT, LIQUID COOLING - CDR.	B0167.	111	1	AREA UI	5.0	1033.0	23.0	-50.0

NOTE: Further information relating to this table is given on pages 3.4-19, 3.4-20 and 3.4-21.

Table 3.4-9.2 (Continued)

MISSION H-3 TRANSFERRED CREW AND EQUIPMENT STOWAGE LIST								
ITEMS REARRANGED IN CM PRIOR TO LM ACTIVATION (3)								
APOLLO COORDINATES								
DESCRIPTION	STOW. ITEM	REF	NO.	STOWAGE LOCATION	WEIGHT	X-C.G.	Y-C.G.	Z-C.G.
EARPIECE, MOLDED (COM. CARR.)-CDR.	EO200.1	111	1	IN ACCES. BAG (HSB/CDR)	NEGL	1048.0	-30.0	34.0
EARTUBE (COM. CARRIER)-CDR.	EO200.2	111	1	IN ACCES. BAG (HSB/CDR)	NEGL	1048.0	-30.0	34.0
TORSO+LIMB SUIT ASSY, EV-LMP.	BO200.1	127	1	IN CM PGA CONTAINER	39.3	1015.0	.0	-19.9
HELMET ASSY, PRESSURE-LMP.	BO200.2	127	1	IN LMP HSB-RH BHD	2.5	1034.0	22.0	-55.0
GLOVES, IV (PAIP)-LMP.	BO200.7	127	1	IN ACCES. BAG (HSB/LMP)	1.6	1034.0	22.0	-55.0
COMMUNICATIONS CARRIER-LMP.	BO200.4	127	1	IN ACCES. BAG (HSB/LMP)	1.6	1034.0	22.0	-55.0
POCKET, CHECKLIST+SCISSORS-LMP.	BO200.5	167	1	ON ICG-LMP./RH STA.	.2	1043.0	24.5	-10.4
POCKET, CHECKLIST-LMP.	BO200.6	167	1	ON ICG-LMP./RH STA.	.2	1043.0	24.5	-10.4
UCTA-LMP.	BO205.	117	1	IN CM PGA CONTAINER	.5	1015.0	.0	-19.9
T-ADAPTER, CNG-LMP.	BO135.	111	1	ON CREW-LMP (RH STA)	.4	1043.0	24.5	-10.4
JACKET ASSY, ICG-LMP.	BO112.1	111	1	ON CREW-LMP (RH STA)	1.8	1043.0	24.5	-10.4
TROUSER ASSY, ICG-LMP.	BO112.2	111	1	ON CREW-LMP (RH STA)	1.8	1043.0	24.5	-10.4
BOOT, RIGHT, ICG-LMP.	BO112.3	111	1	ON CREW-LMP (RH STA)	.4	1043.0	24.5	-10.4
BOOT, LEFT, ICG-LMP.	BO112.4	111	1	ON CREW-LMP (RH STA)	.4	1043.0	24.5	-10.4
EARTUBE, UNIVERSAL-LMP.	EO105.	111	1	ON ICG-LMP./RH STA.	NEGL	1043.0	24.5	-10.4
HEADSET, LIGHTWEIGHT-LMP.	EO104.	111	1	ON CREW-LMP (RH STA)	.4	1043.0	24.5	-10.4
GARMENT, CONSTANT WEAR-LMP.	BO203.	111	1	ON CREW-LMP (RH STA)	.8	1043.0	24.5	-10.4
GARMENT, LIQUID COOLING - LMP.	BO107.	111	1	AREA U1	5.0	1033.0	23.0	-50.0
EARPIECE, MOLDED (COM. CARR.)-LMP.	EO200.1	111	1	IN ACCES. BAG (HSB/LMP)	NEGL	1034.0	22.0	-55.0
EARTUBE (COM. CARRIER)-LMP.	EO200.2	111	1	IN ACCES. BAG (HSB/LMP)	NEGL	1034.0	22.0	-55.0
SUBSYSTEM, FECAL CONTAINMENT-CDR	BO113.	117	1	AREA U1	.3	1033.0	23.0	-50.0
SUBSYSTEM, FECAL CONTAINMENT-LMP	BO113.	117	1	AREA U1	.3	1033.0	23.0	-50.0
WATER SYS ASSY, RETURN CONT.	BO644.	111	1	IN CM PGA CONTAINER	TBD	1015.0	.0	-19.9
CM EQUIP. RELDCL.2					157.31	1022.46	.60	-21.46

NOTE: Further information relating to this table is given on pages 3.4-19, 3.4-20 and 3.4-21.

Table 3.4-9.2 (Continued)

MISSION H-3 TRANSFERRED CREW AND EQUIPMENT STOWAGE LIST							APOLLO COORDINATES		
ITEMS REARRANGED IN CM PRIOR TO LM ACTIVATION (4)							X-C.G.	Y-C.G.	Z-C.G.
DESCRIPTION	STOW. ITEM	REF	NO.	STOWAGE LOCATION	WEIGHT				
TORSO+LIMB SUIT ASSY, IV-CMP.	80201.1	127	1	ON CREW-CMP(LH STA)	30.5	1043.0	-24.5	-10.4	
HELMET ASSY, PRESSURE-CMP.	80201.2	127	1	ON CREW-CMP(LH STA)	2.5	1043.0	-24.5	-10.4	
GLOVES, IV(PAIR)-CMP.	80201.3	127	1	ON CREW-CMP(LH STA)	1.7	1043.0	-24.5	-10.4	
COMMUNICATIONS CARRIER-CMP.	80201.4	127	1	ON CREW-CMP(LH STA)	1.6	1043.0	-24.5	-10.4	
POCKET, CHECKLIST+SCISSORS-CMP.	80201.5	167	1	ON PGA (CREW-LH STA)	.2	1043.0	-24.5	-10.4	
POCKET, CHECKLIST-CMP	80201.6	167	1	ON PGA (CREW-LH STA)	.2	1043.0	-24.5	-10.4	
BAG, MOTION SICKNESS-CMP.	A0208.	111	1	ON PGA (CREW-LH STA)	.1	1043.0	-24.5	-10.4	
UCTA-CMP.	R0205.	117	1	ON CREW-CMP(LH STA)	.5	1043.0	-24.5	-10.4	
T-ADAPTER, CWG-CMP.	80135.	111	1	IN ADAPTER BAG (AB)	.4	1012.0	22.0	-23.0	
JACKET ASSY, ICG-CMP.	80112.1	111	1	IN CM PGA CONTAINER	1.8	1015.0	.0	-19.9	
TROUSER ASSY, ICG-CMP.	80112.2	111	1	IN CM PGA CONTAINER	1.8	1015.0	.0	-19.9	
BOOT, RIGHT, ICG-CMP.	80112.3	111	1	IN CM PGA CONTAINER	.4	1015.0	.0	-19.9	
BOOT, LEFT, ICG-CMP.	80112.4	111	1	IN CM PGA CONTAINER	.4	1015.0	.0	-19.9	
EARTUBE, UNIVERSAL-CMP.	E0105.1	111	1	ON ICG(PGA CONTAINER)	NEGL	1015.0	.0	-19.9	
HEADSET, LIGHTWEIGHT-CMP.	E0104.	111	1	AREA AB	.4	1012.0	22.0	-23.0	
SUBSYSTEM, FECAL CONTAINMENT-CMP	80113.	117	1	ON CREW-CMP(LH STA)	.3	1043.0	-24.5	-10.4	
TORSO+LIMB SUIT ASSY, EV-CDR.	80200.1	127	1	ON CREW-CDR(CTR.STA)	39.3	1043.0	.0	-10.4	
HELMET ASSY, PRESSURE-CDR.	80200.2	127	1	ON CREW-CDR(CTR.STA)	2.5	1043.0	.0	-10.4	
GLOVES, IV(PAIR)-CDR.	80200.3	127	1	ON CREW-CDR(CTR.STA)	1.7	1043.0	.0	-10.4	
COMMUNICATION CARRIER-CDR.	80200.4	127	1	ON CREW-CDR(CTR.STA)	1.6	1043.0	.0	-10.4	
POCKET, CHECKLIST+SCISSORS-CDR.	80200.5	167	1	ON PGA(CREW-CTR STA)	.2	1043.0	.0	-10.4	
POCKET, CHECKLIST-CDR.	80200.6	167	1	ON PGA(CREW-CTR STA)	.2	1043.0	.0	-10.4	
UCTA-CDR.	80205.	117	1	ON CREW-CDR(CTR.STA)	.5	1043.0	.0	-10.4	
T-ADAPTER, CWG-CDR.	80135.	111	1	IN ADAPTER BAG (AB)	.4	1012.0	22.0	-23.0	
JACKET ASSY, ICG-CDR.	80112.1	111	1	IN CM PGA CONTAINER	1.8	1015.0	.0	-19.9	
TROUSER ASSY, ICG-CDR.	80112.2	111	1	IN CM PGA CONTAINER	1.8	1015.0	.0	-19.9	
BOOT, RIGHT, ICG-CDR.	80112.3	111	1	IN CM PGA CONTAINER	.4	1015.0	.0	-19.9	
BOOT, LEFT, ICG-CDR.	80112.4	111	1	IN CM PGA CONTAINER	.4	1015.0	.0	-19.9	
EARTUBE, UNIVERSAL-CDR.	E0105.	111	1	ON ICG(PGA CONTAINER)	NEGL	1015.0	.0	-19.9	
HEADSET, LIGHTWEIGHT-CDR.	E0104.	111	1	AREA AB	.4	1012.0	22.0	-23.0	
GARMENT, CONSTANT WEAR-CDR.	R0208.	111	1	IN CM PGA CONTAINER	.8	1015.0	.0	-19.9	
GARMENT, LIQUID COOLING - CDR.	80137.	111	1	ON CREW-CDR(CTR.STA)	5.0	1043.0	.0	-10.4	

NOTE: Further information relating to this table is given on pages 3.4-19, 3.4-20 and 3.4-21.

Table 3.4-9.2 (Continued)

MISSION H-3 TRANSFERRED CREW AND EQUIPMENT STOWAGE LIST								
ITEMS REARRANGED IN CM PRIOR TO LM ACTIVATION (4)								
						APOLLO COORDINATES		
DESCRIPTION	STOW. ITEM	REF	NO.	STOWAGE LOCATION	WEIGHT	X-C.G.	Y-C.G.	Z-C.G.
EARPIECE, MILDRED (COMM. CARR.)-CDR.	E0200.1	111	1	ON CREW-CDR(CTR. STA)	NEGL	1043.0	.0	-10.4
EARTUBE (COMM. CARRIER)-CDR.	E0200.2	111	1	ON CREW-CDR(CTR. STA)	NEGL	1043.0	.0	-10.4
TORSO+LIMB SUIT ASSY, EV-LMP.	00200.1	127	1	ON CREW-LMP(RH STA)	39.3	1043.0	24.5	-10.4
HELMET ASSY, PRESSURE-LMP.	00200.2	127	1	ON CREW-LMP(RH STA)	2.5	1043.0	24.5	-10.4
GLOVES, IV (PAIR)-LMP.	00200.7	127	1	ON CREW-LMP(RH STA)	1.6	1043.0	24.5	-10.4
COMMUNICATIONS CARRIER-LMP.	00200.4	127	1	ON CREW-LMP(RH STA)	1.6	1043.0	24.5	-10.4
POCKET, CHECKLIST+SCISSORS-LMP.	00200.5	167	1	ON PGA (CREW-RH STA)	.2	1043.0	24.5	-10.4
POCKET, CHECKLIST-LMP.	00200.6	167	1	ON PGA (CREW-RH STA)	.2	1043.0	24.5	-10.4
UCTA-LMP.	00205.	117	1	ON CREW-LMP(RH STA)	.5	1043.0	24.5	-10.4
T-ADAPTER, CWG-LMP.	00135.	111	1	IN ADAPTER BAG (AB)	.4	1012.0	22.0	-23.0
JACKET ASSY, ICG-LMP.	00112.1	111	1	IN CM PGA CONTAINER	1.8	1015.0	.0	-19.9
TROUSER ASSY, ICG-LMP.	00112.2	111	1	IN CM PGA CONTAINER	1.8	1015.0	.0	-19.9
BOOT, RIGHT, ICG-LMP.	00112.3	111	1	IN CM PGA CONTAINER	.4	1015.0	.0	-19.9
BOOT, LEFT, ICG-LMP.	00112.4	111	1	IN CM PGA CONTAINER	.4	1015.0	.0	-19.9
EARTUBE, UNIVERSAL-LMP.	E0105.	111	1	ON ICG (PGA CONTAINER)	NEGL	1015.0	.0	-19.9
HEADSET, LIGHTWEIGHT-LMP.	E0104.	111	1	AREA AB	.4	1012.0	22.0	-23.0
GARMENT, CONSTANT WEAR-LMP.	00208.	111	1	IN CM PGA CONTAINER	.8	1015.0	.0	-19.9
GARMENT, LIQUID COOLING - LMP.	00107.	111	1	ON CREW-LMP(RH STA)	5.0	1043.0	24.5	-10.4
EARPIECE, MILDRED (COMM. CARR.)-LMP.	E0200.1	111	1	ON CREW-LMP(RH STA)	NEGL	1043.0	24.5	-10.4
EARTUBE (COMM. CARRIER)-LMP.	E0200.2	111	1	ON CREW-LMP(RH STA)	NEGL	1043.0	24.5	-10.4
SUBSYSTEM, FECAL CONTAINMNT-CDR	00113.	117	1	ON CREW-CDR(CTR. STA)	.3	1043.0	.0	-10.4
SUBSYSTEM, FECAL CONTAINMNT-LMP	00113.	117	1	ON CREW-LMP(RH STA)	.3	1043.0	24.5	-10.4
WATER SYS ASSY, RETURN CONT.	06444.	111	1	AFT UEB CENTER (APRX)	TBD	1018.0	.0	.0
CM EQUIP. RELQ.2					157.31	1039.89	2.45	-11.49

NOTE: Further information relating to this table is given on pages 3.4-19, 3.4-20 and 3.4-21.

Table 3.4-9.2 (Continued)

MISSION H-3 TRANSFERRED CREW AND EQUIPMENT STOWAGE LIST								
ITEMS REARRANGED IN LM PRIOR TO LM ACTIVATION (5)								
DESCRIPTION	STOW. ITEM	REF	NO.	STOWAGE LOCATION	WEIGHT	LM COORDINATES		
						X-C.G.	Y-C.G.	Z-C.G.
BRACKET, WEDGE, 16MM CAMERA	A1041.	115	1	ISA(CTR.INST.PANEL)	1.3	268.0	.0	52.0
UTILITY LIGHTS W/CORD + CLAMP	O3006.	115	1	ISA(CTR.INST.PANEL)	1.4	268.0	.0	52.0
UTILITY LIGHTS W/CORD + CLAMP	O3006.	115	1	ISA(CTR.INST.PANEL)	1.4	268.0	.0	52.0
INTERIM STOW. ASSY (ISA)	O3007.	114	* 1	FRONT/CENTR.INST.PNL	7.6	268.0	.0	52.0
BRACKET, CAMERA MOUNT	B1001.1	115	1	IN BRKT.BG(ISA/PNL)	.6	268.0	.0	52.0
BRACKET, CAMERA MOUNT	B1001.1	115	1	IN BRKT.BG(ISA/PNL)	.6	268.0	.0	52.0
BAG, CAMERA MOUNT, BRACKET	O3034.	115	1	ISA(CTR.INST.PANEL)	.3	268.0	.0	52.0
DEVICE, IN-SUIT DRINKING	B1048.	114	2	ISA(CTR.INST.PANEL)	.2	268.0	.0	52.0
BAG, STOWAGE, THERMAL SAMPLES	B1060.	111	2	ISA(CTR.INST.PANEL)	.2	268.0	.0	52.0
SAMPLES, THERMAL COAT. DEGRADE	F1002.	111	2	ISA(CTR.INST.PANEL)	.8	268.0	.0	52.0
LM EQUIP.RELCC.1					14.40	268.00	.00	52.00

NOTE: Further information relating to this table is given on pages 3.4-19, 3.4-20 and 3.4-21.

Table 3.4-9.2 (Continued)

MISSION H-3 TRANSFERRED CREW AND EQUIPMENT STOWAGE LIST								
ITEMS REARRANGED IN LM PRIOR TO LM ACTIVATION (6)								
DESCRIPTION	STOW. ITEM	REF	NO.	STOWAGE LOCATION	WEIGHT	LM COORDINATES		
						X-C.G.	Y-C.G.	Z-C.G.
BRACKET, WEDGE, 16MM CAMERA	A1041.	115	1	ON RH WINDOW BRKT	1.3	287.0	22.0	65.0
UTILITY LIGHTS W/CORD + CLAMP	03005.	115	1	RH CREW STA-INSTAL.	1.4	284.5	6.5	52.0
UTILITY LIGHTS W/CORD + CLAMP	03006.	115	1	LH CREW STA-INSTAL.	1.4	282.5	-6.5	51.0
INTERIM STOW. ASSY (ISA)	03007.	114	* 1	OVER AS ENG. COVER	7.6	260.0	.0	2.2
BRACKET, CAMERA MOUNT	B1001.1	115	1	IN BRKT. BG (ISA/OASE)	.6	260.0	.0	2.2
BRACKET, CAMERA MOUNT	B1001.1	115	1	IN BRKT. BG (ISA/OASE)	.6	260.0	.0	2.2
BAG, CAMERA MOUNT, BRACKET	03034.	115	1	ISA (OVER AS ENG CVR)	.3	280.0	.0	-10.0
DEVICE, IN-SUIT DRINKING	B1048.	114	2	ISA (OVER AS ENG CVR)	.2	280.0	.0	-10.0
BAG, STOWAGE, THERMAL SAMPLES	B1060.	111	2	ISA (OVER AS ENG CVR)	.2	280.0	.0	-10.0
SAMPLES, THERMAL COAT, DEGRADE	F1002.	111	2	ISA (OVER AS ENG CVR)	.8	280.0	.0	-10.0
LM EQUIP. RELOC. 1					14.40	269.09	1.99	16.18

NOTE: Further information relating to this table is given on pages 3.4-19, 3.4-20 and 3.4-21.

Table 3.4-9.2 (Continued)

MISSION H-3 TRANSFERRED CREW AND EQUIPMENT STOWAGE LIST								
ITEMS TRANSFERRED FROM CM INTO LM AT LM ACTIVATION (7)								
APOLLO COORDINATES								
DESCRIPTION	STOW. ITEM	REF	NO.	STOWAGE LOCATION	WEIGHT	X-C.G.	Y-C.G.	Z-C.G.
CREW-COMMANDER (CDR)	THJ	227	1	ON COUCH(CTR CREW STA	171.0	1043.0	.0	-10.4
CREW-LM PILOT (LAP)	THJ	227	1	ON COUCH(RH CREW STA	185.0	1043.0	24.5	-10.4
TORSO+LIMB SUIT ASSY, EV-CUP.	B0200.1	127	1	UN CREW-CDR(CTR STA)	39.3	1043.0	.0	-10.4
HELMET ASSY, PRESSURE-CDR.	B0200.2	127	1	UN CREW-CDR(CTR STA)	2.5	1043.0	.0	-10.4
GLOVES, IV(PAIR)-CDR.	B0200.3	127	1	ON CREW-CDR(CTR STA)	1.7	1043.0	.0	-10.4
COMMUNICATION CARRIER-CDR.	B0200.4	127	1	ON CREW-CDR(CTR STA)	1.6	1043.0	.0	-10.4
POCKET, CHECKLIST+SCISSORS-CDR.	B0200.5	167	1	UN PGA(CREW-CTR STA)	.2	1043.0	.0	-10.4
POCKET, CHECKLIST-CDR.	B0200.6	167	1	ON PGA(CREW-CTR STA)	.2	1043.0	.0	-10.4
UCTA-CDR.	B0205.	117	1	UN CREW-CDR(CTR STA)	.5	1043.0	.0	-10.4
BIOINSTRUMENTATION-CJK.	B0203.	111	1	UN CREW-CDR(CTR STA)	1.1	1043.0	.0	-10.4
GARMENT, LIQUID COOLING - CDR.	B0137.	111	1	ON CREW-CDR(CTR STA)	5.0	1043.0	.0	-10.4
EARPLUGS(PAIR)-CDR.	B0210.	111	1	ON PGA(CREW-CTR STA)	NEGL	1043.0	.0	-10.4
EARPIECE, MULTIMEDICOM CARR)-CDR.	EG200.1	111	1	UN CREW-CDR(CTR STA)	NEGL	1043.0	.0	-10.4
EARTUBE(CUM CARRIER)-CDR.	EG200.2	111	1	ON CREW-CDR(CTR STA)	NEGL	1043.0	.0	-10.4
SUNGLASSES-CDR.	AG200.	117	1	ON CREW-CDR(CTR STA)	.1	1043.0	.0	-10.4
POUCH, SUNGLASSES-CDR.	A0201.	117	1	ON CREW-CDR(CTR STA)	NEGL	1043.0	.0	-10.4
CHRONOGRAPH-CDR.	A0202.	117	1	UN CREW-CDR(CTR STA)	.1	1043.0	.0	-10.4
WATCHBAND-CDR.	A0203.	117	1	ON CREW-CDR(CTR STA)	NEGL	1043.0	.0	-10.4
PENS, DATA RECORDING-CDR.	A0204.	117	1	UN CREW-CDR(CTR STA)	.1	1043.0	.0	-10.4
PEN, MARKER-CDR.	A0205.	117	1	ON CREW-CDR(CTR STA)	NEGL	1043.0	.0	-10.4
PENCIL-CDR.	A0206.	117	1	ON CREW-CDR(CTR STA)	.1	1043.0	.0	-10.4
PENLIGHTS-CDR.	B0206.	117	1	UN CREW-CDR(CTR STA)	.3	1043.0	.0	-10.4
BIUBELT ASSY-CDR.	B0207.	117	1	ON CREW-CDR(CTR STA)	.2	1043.0	.0	-10.4
DOSIMETER, PERSONAL-CDR.	J0200.	117	1	UN CREW-CDR(CTR STA)	.4	1043.0	.0	-10.4
DOSIMETER, PASSIVE-CDR.	D0201.	117	1	CWG POCKET(CREW-CDR)	NEGL	1043.0	.0	-10.4
TORSO+LIMB SUIT ASSY, EV-LMP.	B0200.1	127	1	ON CREW-LMP(RH STA)	39.3	1043.0	24.5	-10.4
HELMET ASSY, PRESSURE-LMP.	B0200.2	127	1	ON CREW-LMP(RH STA)	2.5	1043.0	24.5	-10.4
GLOVES, IV(PAIR)-LMP.	B0200.7	127	1	ON CREW-LMP(RH STA)	1.6	1043.0	24.5	-10.4
COMMUNICATIONS CARRIER-LMP.	J0200.4	127	1	ON CREW-LMP(RH STA)	1.6	1043.0	24.5	-10.4
POCKET, CHECKLIST+SCISSORS-LMP.	B0200.5	167	1	UN PGA(CREW-RH STA)	.2	1043.0	24.5	-10.4
POCKET, CHECKLIST-LMP.	B0200.6	167	1	ON PGA(CREW-RH STA)	.2	1043.0	24.5	-10.4

NOTE: Further information relating to this table is given on pages 3.4-19, 3.4-20 and 3.4-21.

Table 3.4-9.2 (Continued)

MISSION H-3 TRANSFERRED CREW AND EQUIPMENT STOWAGE LIST								
ITEMS TRANSFERRED FROM CM INTO LM AT LM ACTIVATION (7)								
						APOLLO COORDINATES		
DESCRIPTION	STOW. ITEM	REF	QU.	STOWAGE LOCATION	WEIGHT	X-C.G.	Y-C.G.	Z-C.G.
UCTA-LMP.	B0205.	117	1	UN CREW-LMP(RH STA)	.5	1043.0	24.5	-10.4
BIOINSTRUMENTATION-LMP.	B0203.	111	1	ON CREW-LMP(RH STA)	1.1	1043.0	24.5	-10.4
GARMENT, LIQUID COOLING - LMP.	B0107.	111	1	UN CREW-LMP(RH STA)	5.0	1043.0	24.5	-10.4
EARPLUGS(PAIR)-LMP.	B0210.	111	1	UN PGA (CREW-RH STA)	NEGL	1043.0	24.5	-10.4
EARPIECE, MOLDED(COMM.CARR.)LMP.	E0200.1	111	1	ON CREW-LMP(RH STA)	NEGL	1043.0	24.5	-10.4
EARTUBE(COMM.CARRIER)-LMP.	E0200.2	111	1	UN CREW-LMP(RH STA)	NEGL	1043.0	24.5	-10.4
SUNGLASSES-LMP.	A0200.	117	1	UN CREW-LMP(RH STA)	.1	1043.0	24.5	-10.4
POUCH, SUNGLASSES-LMP.	A0201.	117	1	UN CREW-LMP(RH STA)	NEGL	1043.0	24.5	-10.4
CHRONOGRAPH-LMP.	A0202.	117	1	ON CREW-LMP(RH STA)	.1	1043.0	24.5	-10.4
WATCHBAND-LMP.	A0203.	117	1	ON CREW-LMP(RH STA)	NEGL	1043.0	24.5	-10.4
PENS, DATA RECORDING-LMP.	A0204.	117	1	UN CREW-LMP(RH STA)	.1	1043.0	24.5	-10.4
PENS, MARKER-LMP.	A0205.	117	1	UN CREW-LMP(RH STA)	NEGL	1043.0	24.5	-10.4
PENCIL-LMP.	A0206.	117	1	ON CREW-LMP(RH STA)	.1	1043.0	24.5	-10.4
PENLIGHTS-LMP.	B0206.	117	1	ON CREW-LMP(RH STA)	.3	1043.0	24.5	-10.4
BIOBELT ASSY-LMP.	B0207.	117	1	UN CREW-LMP(RH STA)	.2	1043.0	24.5	-10.4
DOSIMETER, PERSONAL-LMP.	D0200.	117	1	UN CREW-LMP(RH STA)	.4	1043.0	24.5	-10.4
DOSIMETER, PASSIVE-LMP.	D0201.	117	1	CMG POCKET (CREW-LMP)	NEGL	1043.0	24.5	-10.4
LM ACTIVATION CHECKLIST	A0114.12	114	1	IN FDF (R3)	.5	1072.0	26.0	9.0
LM L.S.CHECKLIST	A0114.10	114	1	IN FDF (R3)	1.0	1072.0	26.0	9.0
LM SYSTEMS ACTIVATION CHECKLIST	A0114.12	114	1	IN FDF (R3)	.5	1072.0	26.0	9.0
LM TIMELINE BOOK	A0114.14	114	1	IN FDF (R3)	.5	1072.0	26.0	9.0
LM XFR DATA CARD KIT	A0114.1H	114	1	IN FDF (R3)	.6	1072.0	26.0	9.0
LM DATA CARD BOOK	A0114.19	114	1	IN FDF (R3)	.3	1072.0	26.0	9.0
LM ORBIT MONITOR CHART	A0114.22	114	1	IN FDF (R3)	.3	1072.0	26.0	9.0
DOSIMETER, PASSIVE RADIATION	D0101.	111	1	16MM MAG BAG (R13)	NEGL	1024.0	45.0	-26.0
SCISSORS	B0204.	111	1	UN CREW-COR(CTR.STA)	.5	1043.0	.0	-10.4
BAG, STOW+XFR, 16MM MAG.	00300.	111	1	AREA R13	.3	1024.0	45.0	-26.0
BAG, 70 MM MAG(LM XFR)	00301.	111	1	AREA R13	.5	1024.0	45.0	-26.0
MAGAZINE, 16MM DATA ACQUISITION	A0101.1	111	1	IN XFR BAG (R13)	1.0	1024.0	45.0	-26.0
MAGAZINE, 16MM DATA ACQUISITION	A0101.1	111	1	IN XFR BAG (R13)	1.0	1024.0	45.0	-26.0
MAGAZINE, 16MM DATA ACQUISITION	A0101.1	111	6	IN XFR BAG (R13)	6.0	1024.0	45.0	-26.0

NOTE: Further information relating to this table is given on pages 3.4-19, 3.4-20 and 3.4-21.

Table 3.4-9.2 (Continued)

MISSION M-3 TRANSFERRED CREW AND EQUIPMENT STOWAGE LIST								
ITEMS TRANSFERRED FROM CM INTO LM AT LM ACTIVATION (7)								
APOLLO COORDINATES								
DESCRIPTION	STOW. ITEM	REF	NO.	STOWAGE LOCATION	WEIGHT	X-C.G.	Y-C.G.	Z-C.G.
BAG, STOW+XFR, 164M MAG.	U6393.	111	1	AREA R13	.1	1024.0	45.0	-26.0
MAGAZINE, 70 MM L.S. HASSEL.	A0108.1	111	3	AREA R13	4.2	1024.0	45.0	-26.0
DISPENSER, TISSUE	B0103.	111	1	AREA A9	1.4	1012.0	22.0	-23.0
MAGAZINE, 70MM L.S. HASSEL BLAD	A0108.1	111	2	IN XFR BAG (R13)	2.8	1024.0	45.0	-26.0
SUBSYSTEM, FECAL CONTAINMNT-CDK	B0113.	117	1	ON CREW-COR(CTR. STA)	.3	1043.0	.0	-10.4
SUBSYSTEM, FECAL CONTAINMNT-LMP	B0113.	117	1	ON CREW-LMP(RH STA)	.3	1043.0	24.5	-10.4
BAG, 70MM MAG. (LM XFR)	U6430.	111	1	AREA R13	.5	1024.0	45.0	-26.0
2 CREW+EQUIP, CM-LM					485.30	1042.49	13.83	-10.82

NOTE: Further information relating to this table is given on pages 3.4-19, 3.4-20 and 3.4-21.

Table 3.4-9.2 (Continued)

MISSION H-3 TRANSFERRED CREW AND EQUIPMENT STORAGE LIST								
ITEMS TRANSFERRED FROM CM INTO LM AT LM ACTIVATION (B)								
LM COORDINATES								
DESCRIPTION	STOW. ITEM	REF	NO.	STOWAGE LOCATION	WEIGHT	X-C.G.	Y-C.G.	Z-C.G.
CREW-COMMANDER (CDR)	T6D	227	1	LH CREW STATION-	171.0	260.0	-22.0	45.0
CREW-LM PILOT (LMP)	T6D	227	1	RH CREW STATION-	185.0	260.0	22.0	45.0
TORSO+LIMB SUIT ASSY, EV-CDR.	B0200.1	127	1	ON CREW(LH CREW STA)	39.3	260.0	-22.0	45.0
HELMET ASSY, PRESSURE-CDR.	B0200.2	127	1	ON CREW(LH CREW STA)	2.5	260.0	-22.0	45.0
GLOVES, IV(PAIR)-CDR.	B0200.3	127	1	ON CREW(LH CREW STA)	1.7	260.0	-22.0	45.0
COMMUNICATION CARRIER-CDR.	B0200.4	127	1	ON CREW(LH CREW STA)	1.6	260.0	-22.0	45.0
POCKET,CHECKLIST+SCISSORS-CDR.	HJ200.5	167	1	ON PGA-CDR(ON CREW)	.2	250.6	-22.0	43.4
POCKET,CHECKLIST-CDR.	B0200.6	167	1	ON PGA-CDR(ON CREW)	.2	250.6	-22.0	43.4
UCTA-CDR.	B0205.	117	1	ON CREW(LH CREW STA)	.5	260.0	-22.0	45.0
BIOINSTRUMENTATION-CDR.	B0205.	111	1	ON CREW(LH CREW STA)	1.1	260.0	-22.0	45.0
GARMENT, LIQUID COOLING - CDR.	B0107.	111	1	ON CREW(LH CREW STA)	5.0	260.0	-22.0	45.0
EARPLUGS(PAIR)-CDR.	B0210.	111	1	ON PGA-CDR(ON CREW)	NEGL	250.6	-22.0	43.4
EARPIECE, MOLDED(COM. CARR)-CDR.	E0200.1	111	1	UN CREW(LH CREW STA)	NEGL	260.0	-22.0	45.0
EARTUBE(COM. CARRIER)-CDR.	E0200.2	111	1	ON CREW(LH CREW STA)	NEGL	260.0	-22.0	45.0
SUNGLASSES-CDR.	A0200.	117	1	ON CREW(LH CREW STA)	.1	260.0	-22.0	45.0
POUCH, SUNGLASSES-CDR.	A0201.	117	1	ON CREW(LH CREW STA)	NEGL	260.0	-22.0	45.0
CHRONOGRAPH-CDR.	A0202.	117	1	ON CREW(LH CREW STA)	.1	260.0	-22.0	45.0
WATCHBAND-CDR.	A0203.	117	1	ON CREW(LH CREW STA)	NEGL	260.0	-22.0	45.0
PENS, DATA RECORDING-CDR.	A0204.	117	1	ON CREW(LH CREW STA)	.1	260.0	-22.0	45.0
PEN, MARKER-CDR.	A0205.	117	1	ON CREW(LH CREW STA)	NEGL	260.0	-22.0	45.0
PENCIL-CDR.	A0206.	117	1	ON CREW(LH CREW STA)	.1	260.0	-22.0	45.0
PENLIGHTS-CDR	B0206.	117	1	ON CREW(LH CREW STA)	.3	260.0	-22.0	45.0
BIOBELT ASSY-CDR.	B0207.	117	1	ON CREW(LH CREW STA)	.2	260.0	-22.0	45.0
DOSIMETER, PERSONAL-CDR.	D0200.	117	1	UN CREW(LH CREW STA)	.4	260.0	-22.0	45.0
DOSIMETER, PASSIVE-CDR.	D0201.	117	1	ON CREW(LH CREW STA)	NEGL	260.0	-22.0	45.0
TORSO+LIMB SUIT ASSY, EV-LMP.	B0200.1	127	1	ON CREW(RH CREW STA)	39.3	260.0	22.0	45.0
HELMET ASSY, PRESSURE-LMP.	B0200.2	127	1	ON CREW(RH CREW STA)	2.5	260.0	22.0	45.0
GLOVES, IV(PAIR)-LMP.	B0200.7	127	1	ON CREW(RH CREW STA)	1.6	260.0	22.0	45.0
COMMUNICATIONS CARRIER-LMP.	B0200.4	127	1	ON CREW(RH CREW STA)	1.6	260.0	22.0	45.0
POCKET,CHECKLIST+SCISSORS-LMP.	B0200.5	167	1	ON PGA-LMP(ON CREW)	.2	250.6	22.0	43.4
POCKET,CHECKLIST-LMP.	B0200.6	167	1	UN PGA-LMP(ON CREW)	.2	250.6	22.0	43.4

NOTE: Further information relating to this table is given on pages 3.4-19, 3.4-20 and 3.4-21.

Table 3.4-9.2 (Continued)

MISSION H-3 TRANSFERRED CREW AND EQUIPMENT STOWAGE LIST								
ITEMS TRANSFERRED FROM CM INTO LM AT LM ACTIVATION (8)								
LM COORDINATES								
DESCRIPTION	STOW. ITEM	REF	NO.	STOWAGE LOCATION	WEIGHT	X-C.G.	Y-C.G.	Z-C.G.
UCTA-LMP.	B0205.	117	1	ON CREW(RH CREW STA)	.5	260.0	22.0	45.0
BIOINSTRUMENTATION-LMP.	B0203.	111	1	ON CREW(RH CREW STA)	1.1	260.0	22.0	45.0
GARMENT, LIQUID COOLING - LMP.	B0107.	111	1	ON CREW(RH CREW STA)	5.0	260.0	22.0	45.0
EARPLUGS(PAIR)-LMP.	B0210.	111	1	ON PGA-L4P(ON CREW)	NEGL	250.6	22.0	43.4
EARPIECE, MOLDED(COM. CARR.)LMP.	E0200.1	111	1	ON CREW(RH CREW STA)	NEGL	260.0	22.0	45.0
EARTUBE(COMM. CARRIER)-LMP.	E0200.2	111	1	ON CREW(RH CREW STA)	NEGL	260.0	22.0	45.0
SUNGLASSES-LMP.	A0200.	117	1	ON CREW(RH CREW STA)	.1	260.0	22.0	45.0
POUCH, SUNGLASSES-LMP.	A0201.	117	1	ON CREW(RH CREW STA)	NEGL	260.0	22.0	45.0
CHRONOGRAPH-LMP.	A0202.	117	1	ON CREW(RH CREW STA)	.1	260.0	22.0	45.0
WATCHBAND-LMP.	A0203.	117	1	ON CREW(RH CREW STA)	NEGL	260.0	22.0	45.0
PENS, DATA RECORDING-LMP.	A0204.	117	1	ON CREW(RH CREW STA)	.1	260.0	22.0	45.0
PENS, MARKER-LMP.	A0205.	117	1	ON CREW(RH CREW STA)	NEGL	260.0	22.0	45.0
PENCIL-LMP.	A0206.	117	1	ON CREW(RH CREW STA)	.1	260.0	22.0	45.0
PENLIGHTS-LMP.	B0206.	117	1	ON CREW(RH CREW STA)	.3	260.0	22.0	45.0
BIOBELT ASSY-LMP.	B0207.	117	1	ON CREW(RH CREW STA)	.2	260.0	22.0	45.0
DOSIMETER, PERSONAL-LMP.	D0200.	117	1	ON CREW(RH CREW STA)	.4	260.0	22.0	45.0
DOSIMETER, PASSIVE-LMP.	D0201.	117	1	ON CREW(RH CREW STA)	NEGL	260.0	22.0	45.0
LM ACTIVATION CHECKLIST	A0114.12	114	1	LM XFR DATA CARD KIT	.5	280.8	-20.0	14.0
LM L.S. CHECKLIST	A0114.10	114	1	LM XFR DATA CARD KIT	1.0	280.8	-20.0	14.0
LM SYSTEMS ACTIVATION CHECKLIST	A0114.12	114	1	L4 XFR DATA CARD KIT	.5	280.8	-20.0	14.0
LM TIMELINE BOOK	A0114.14	114	1	LM XFR DATA CARD KIT	.5	280.8	-20.0	14.0
LM XFR DATA CARD KIT	A0114.18	114	1	FLIGHT DATA FILE CTR	.6	280.8	-20.0	14.0
LM DATA CARD BOOK	A0114.19	114	1	LM XFR DATA CARD KIT	.3	280.8	-20.0	14.0
LM ORBIT MONITOR CHART	A0114.22	114	1	LM XFR DATA CARD KIT	.3	280.8	-20.0	14.0
DOSIMETER, PASSIVE RADIATION	D0101.	111	1	16MM MAG BAG(RHSSC)	NEGL	238.4	38.6	46.0
SCISSORS	B0204.	111	1	ON CREW(LH CREW STA)	.5	260.0	-22.0	45.0
BAG, STOW+XFR, 16MM MAG.	D0380.	111	1	RH SIDE STOW.COMPT.	.3	238.4	38.6	46.0
BAG, 70 MM MAG(LM XFR)	U0381.	111	1	RH SIDE STOW.COMPT.	.5	238.4	38.6	46.0
MAGAZINE, 16MM DATA ACQUISITION	A0101.1	111	1	ON CAM/RH WINDOW BKT	1.0	287.0	22.0	65.0
MAGAZINE, 16MM DATA ACQUISITION	A0101.1	111	1	XFR BAG(ISA/OASE)	1.0	260.0	.0	2.2
MAGAZINE, 16MM DATA ACQUISITION	A0101.1	111	6	XFR BAG (RHSSC)	6.0	238.4	38.6	46.0

NOTE: Further information relating to this table is given on pages 3.4-19, 3.4-20 and 3.4-21.

Table 3.4-9.2 (Continued)

MISSION H-3 TRANSFERRED CREW AND EQUIPMENT STORAGE LIST								
ITEMS TRANSFERRED FROM CM INTO LM AT LM ACTIVATION (8)								
DESCRIPTION	STOW. ITEM	REF	NO.	STOWAGE LOCATION	WEIGHT	LM COORDINATES		
						X-C.G.	Y-C.G.	Z-C.G.
BAG, STOW+XFR, 16MM MAG.	O6393.	111	1	ISA (OVER AS ENG CVR)	.1	280.0	.0	-10.0
MAGAZINE, 70 MM L.S. HASSEFL.	A0108.1	111	3	RH SIDE STOW.COMPT.	4.2	238.4	38.6	46.0
DISPENSER, TISSUE	B0103.	111	1	RH SIDE STOW.COMPT.	1.4	238.4	38.6	46.0
MAGAZINE, 70MM L.S.HASSELBLAD	A0109.1	111	2	RH SIDE STOW.COMPT.	2.8	238.4	38.6	46.0
SUBSYSTEM, FECAL CONTAINMNT-COR	B0113.	117	1	ON CREW (LH CREW STA)	.3	260.0	-22.0	45.0
SUBSYSTEM, FECAL CONTAINMNT-LMP	B0113.	117	1	ON CREW (RH CREW STA)	.3	260.0	22.0	45.0
BAG, 70MM MAG. (LM XFR)	U6430.	111	1	RH SIDE STOW.COMPT.	.5	238.4	38.6	46.0
2 CREW+EQUIP, CM-LM					485.30	259.50	1.75	44.74

NOTE: Further information relating to this table is given on pages 3.4-19, 3.4-20 and 3.4-21.

Table 3.4-9.2 (Continued)

MISSION H-3 TRANSFERRED CREW AND EQUIPMENT STORAGE LIST								
ITEMS TRANSFERRED FROM LM INTO CM AT LM ACTIVATION (9)								
DESCRIPTION	STOW. ITEM	REF	NO.	STORAGE LOCATION	WEIGHT	LM COORDINATES		
						X-C.G.	Y-C.G.	Z-C.G.
CSM/LM UMBILICAL	TBD	222	1	In LM TUNNEL	1.1	300.0	.0	.0
EQUIP.XFR,LM-CM 1					1.10	300.00	.00	.00

NOTE: Further information relating to this table is given on pages 3.4-19, 3.4-20 and 3.4-21.

U
N
I
T
E
D
S
T
A
T
E
S
O
F
A
M
E
R
I
C
A

Amendment 88
10/5/70

Table 3.4-9.2 (Continued)

MISSION H-3 TRANSFERRED CREW AND EQUIPMENT STORAGE LIST								
ITEMS TRANSFERRED FROM LM INTO CM AT LM ACTIVATION (10)								
DESCRIPTION	STOW. ITEM	REF	NO.	STORAGE LOCATION	WEIGHT	APOLLO COORDINATES		
						X-C.G.	Y-C.G.	Z-C.G.
CSM/LM UMBILICAL	TBD	222	1	UNDER RH COUCH	1.1	1018.0	24.5	-15.0
EQUIP.XFR.LM-CM 1					1.10	1018.00	24.50	-15.00

NOTE: Further information relating to this table is given on pages 3.4-19, 3.4-20 and 3.4-21.

Table 3.4-9.2 (Continued)

MISSION H-3 TRANSFERRED CREW AND EQUIPMENT STOWAGE LIST								
ITEMS OFFLOADED FROM ASC. STAGE PRIOR TO LUNAR LIFT-OFF (11)								
LM COORDINATES								
DESCRIPTION	STOW. ITEM	REF	NO.	STOWAGE LOCATION	WEIGHT	X-C.G.	Y-C.G.	Z-C.G.
EARPLUGS(PAIR)-CDR.	B0210.	111	1	ON PGA-COR(ON CREW)	NEGL	250.6	-22.0	43.4
EARPLUGS(PAIR)-LMP.	00210.	111	1	ON PGA-LMP(ON CREW)	NEGL	250.6	22.0	43.4
BATTERY, PLSS	B1004.	111	2	LH SIDE STOW.COMPT.	11.0	235.0	-34.0	45.0
BRACKET,CAMERA MOUNT	B1001.1	115	1	IN BRKT.BG(ISA/OASE)	.6	260.0	.0	2.2
BAG, CAMERA MOUNT.BRACKET	03034.	115	1	ISA(OVER AS ENG CVR)	.3	280.0	.0	-10.0
FILTER,POLARIZING	A1005.	115	1	JN 60MM LENS(RHSSC)	.2	238.4	38.6	46.0
CAMERA,LS ELECT.HASSELBLAD	A1015.	115	1	RH SIDE STOW.COMPT.	3.1	238.4	38.6	46.0
LENS, 60 MM	A1016.	115	1	RH SIDE STOW.COMPT.	1.8	238.4	38.6	46.0
ADAPTER,BRKT,RT,ANGLE 16MM CAM	A1021.	115	1	LH SIDE STOW.COMPT.	.2	235.0	-34.0	45.0
CABLE,REMOTE CONTROL,16MM CAM.	A1022.	115	1	LH SIDE STOW.COMPT.	.7	235.0	-34.0	45.0
TRIGGER,ELECT.HASSELBLAD CAMRA	A1027.	115	1	RH SIDE STOW.COMPT.	.2	238.4	38.6	46.0
HANDLE,ELECT.HASSELBLAD CAMERA	A1028.	115	1	RH SIDE STOW.COMPT.	.5	238.4	38.6	46.0
TETHER,EVA RETRACTABLE-CDR.	A1029.	115	1	UN CDR PLSS(RechG ST	.2	262.8	-20.8	15.4
TETHER,EVA RETRACTABLE-LMP.	A1029.	115	1	ON LMP PLSS(CBN.FLR)	.2	219.7	.0	44.7
REMOTE CONTRL UNIT-PLSS	B1001.	115	2	ON MINUS Z27 BHD-RCU	10.2	280.0	.0	-21.5
BOOTS, LUNAR (PR.)-CDR.	B1018.	115	1	UPR.BOOT BOX	4.5	280.8	-20.0	-9.5
BOOTS, LUNAR (PR.)-LMP.	B1018.	115	1	LWR.BOOT BOX	4.5	273.8	-20.0	-9.5
BAG ASSY,LEC + W.T.	B1020.1	115	1	LH SIDE STOW.COMPT.	.2	235.0	-34.0	45.0
CONVEYOR ASSY,LUNAR EQUIP(LEC)	B1020.2	115	1	LH SIDE STOW.COMPT.	1.2	235.0	-34.0	45.0
PLSS/EVC ASSY-CDR.	B1024.	114	1	RECHARGE STA.-PLSS	83.1	262.8	-20.8	15.4
PLSS/EVC ASSY-LMP.	B1025.	114	1	ON CABIN FLOOR-PLSS	83.0	219.7	.0	44.7
BAG,JETTISON STOWAGE	B1027.	115	1	LH SIDE STOW.COMPT.	.9	235.0	-34.0	45.0
BUDDY SLSS ASSY	B1052.	116	1	ON PLUS Z27 BHD	10.9	260.0	-37.0	28.0
CONTAINER,HUDDY SLSS ASSY-STOW	03059.	119	1	ON PLUS Z27 BHD	3.1	260.0	-37.0	28.0
LM FOOD ASSY NO.1(2 2/3 M.DAY)	C1000.	115	1	FOOD CONTAINER NO.1	2.3	279.8	-20.0	.0
LM FOOD ASSY NO.2(2 2/3 M.DAY)	C1000.	115	1	FOOD CONTAINER NO.2	3.0	273.8	-20.0	.0
ADAPTER SRC/DPS	03004.	115	1	ON UPS(SRC RACK NO.1	2.4	257.4	-20.7	-6.0
ADAPTER SRC/DPS	03004.	115	1	ON UPS(SRC RACK NO.2	2.4	265.9	-20.7	-6.0
CANNISTER,ECS LIQH	03008.	115	1	AFT OF ASC.ENG.COVER	9.2	245.8	8.8	-15.0
URINE COLLECTION ASSY (SMALL)	03009.	115	3	RH SIDE STOW.COMPT.	.9	238.4	38.6	46.0
CONTAINER ASSY,DISPOSAL (LWR)	03012.	115	2	LH SIDE STOW.COMPT.	3.6	235.0	-34.0	45.0
CONTAINER,PLSS CONDENSATE	03014.	115	1	LH MID-SECTION AREA	4.4	264.8	-13.0	15.0

NOTE: Further information relating to this table is given on pages 3.4-19, 3.4-20 and 3.4-21.

Amendment 92
12/4/70

Table 3.4-9.2 (Continued)

MISSION H-3 TRANSFERRED CREW AND EQUIPMENT STOWAGE LIST								
ITEMS UNFLOADED FROM ASC. STAGE PRIOR TO LUNAR LIFT-OFF (11)								
LM COORDINATES								
DESCRIPTION	STOW. ITEM	REF	NO.	STOWAGE LOCATION	WEIGHT	X-C.G.	Y-C.G.	Z-C.G.
STRAP, ECS LIGH CANNISTER	03024.	115	1	CANNISTR (REAR, ASC. EC	.1	245.8	8.8	-15.0
HAMMOCK ASSY-COM.	03048.	115	1	LH SIDE STOW.COMPT.	4.1	235.0	-34.0	45.0
HAMMOCK ASSY-LMP.	03050.	115	1	LH SIDE STOW.COMPT.	3.9	235.0	-34.0	45.0
CONTR, CONT. SAMPLE RETRN (EMPTY)	G4016.	115	1	LH SIDE STOW.COMPT.	.6	235.0	-34.0	45.0
ARM RESTS-CDK	TBD	346	2	RH CREW STATION-	2.2	260.0	22.0	45.0
ARM RESTS-LMP.	TBD	346	2	LH CREW STATION-	2.2	260.0	-22.0	45.0
BAG, 16 MM CAMERA-STWG.	03062.	111	1	LH SIDE STOW.COMPT.	1.0	235.0	-34.0	45.0
B+W TV SYSTEM	E1000.	111	1	ON MINUS Z27 BHD- TV	7.6	285.0	.0	-21.5
COLLECTION BAG, CALIB. PLSS FW	81026.	111	1	LH SIDE STOW.COMPT.	.8	235.0	-34.0	45.0
COLLECTION BAG, CAL. PLSS FW WS	81026.1	111	1	LH SIDE STOW.COMPT.	.5	235.0	-34.0	45.0
CAM./POWR. PAK ASSY, 16MM L.S.	A1043.	111	1	LH SIDE STOW.COMPT.	8.9	235.0	-34.0	45.0
LEFT AT LUNAR SITE					280.70	246.94	-12.94	25.01

NOTE: Further information relating to this table is given on pages 3.4-19, 3.4-20 and 3.4-21.

Table 3.4-9.2 (Continued)

MISSION H-3 TRANSFERRED CREW AND EQUIPMENT STOWAGE LIST								
ITEMS UNLOADED INTO ASC. STAGE PRIOR TO LUNAR LIFT-OFF (12)								
DESCRIPTION	STOW. ITEM	REF	NO.	STOWAGE LOCATION	WEIGHT	LM COORDINATES		
						X-C.G.	Y-C.G.	Z-C.G.
SAMPLE CONTAINER, MAGNETIC SHLD	G4039.	111	1	ISA(OVER AS ENG CVR)	1.0	280.0	.0	-10.0
SAMPLE CONT., SPECIAL ENVIRON.	G4040.	111	1	LH SIDE STOW.COMPT.	1.0	235.0	-34.0	45.0
CONTRN.SAMPL.RET.NO.1(LOADED)	G4003.	115	1	SRC RACK NO.1-LWR.	65.0	257.4	-20.7	-6.0
CONTRN.SAMPL.RET.NO.2(LOADED)	G4004.	115	1	SRC RACK NO.2-UPR.	65.0	265.9	-20.7	-6.0
S.W.C. EXPERIMENT	G4011.	115	1	ISA(OVER AS ENG CVR)	.3	280.0	.0	-10.0
CONTR.CONT.SMPL.RETRN(LOADED)	G4016.	115	1	ISA(OVER AS ENG CVR)	2.6	280.0	.0	-10.0
CASSETTE,CLOSE-UP CAMERA(CSC)	J1001.	115	1	ISA(OVER AS ENG CVR)	.5	280.0	.0	-10.0
BAG,SAMPLE RETURN	D3060.	111	1	ON PLUS Z27 BHD	35.0	260.0	-37.0	28.0
BAG, LUNAR EQUIPMENT TRANSFER	D3018.	111	1	ISA(OVER AS ENG CVR)	.9	280.0	.0	-10.0
BAG,SOLAR WIND COMP. EXP.	G4011.1	111	1	ISA(OVER AS ENG CVR)	180	280.0	.0	-10.0
WEIGH BAG WITH FOOTBALL SIZ RK	G4018.	111	1	LH SIDE STOW.COMPT.	30.0	235.0	-34.0	45.0
WEIGH BAG WITH FOOTBALL SIZ RK	G4018.	111	1	ISA(OVER AS ENG CVR)	30.0	280.0	.0	-10.0
WEIGH BAG WITH SMALL ROCKS	G4018.	111	1	ISA(OVER AS ENG CVR)	15.0	280.0	.0	-10.0
UNLOAD AT LUN.SITE					246.31	261.81	-20.46	4.43

NOTE: Further information relating to this table is given on pages 3.4-19, 3.4-20 and 3.4-21.

Table 3.4-9.2 (Continued)

MISSION H-3 TRANSFERRED CREW AND EQUIPMENT STOWAGE LIST								
ITEMS REARRANGED IN LM PRIOR TO LUNAR LIFT-OFF (13)								
DESCRIPTION	STOW. ITEM	REF	NO.	STOWAGE LOCATION	WEIGHT	LM COORDINATES		
						X-C.G.	Y-C.G.	Z-C.G.
MAGAZINE, 16MM DATA ACQUISITION	A0101.1	111	1	ON CAM/RH WINDOW BKT	1.0	287.0	22.0	65.0
MAGAZINE, 70MM L.S.HASSELBLAD	A0108.1	111	2	70MM XFR BAG(KHSSC)	2.8	238.4	38.6	46.0
OXYGEN PURGE SYS(OPSI)-CDR.	B1012.	115	1	SRC RACK NO.1-LWR.	35.0	257.4	-20.7	-6.0
OXYGEN PURGE SYS(OPSI)-LMP.	B1012.	115	1	SRC RACK NO.2-UPR.	35.0	265.9	-20.7	-6.0
HELMET STOWAGE BAG-CDR.	B1013.	115	1	ON CABIN FLOOR	1.4	221.0	-18.3	53.0
LUNAR EVA VISOR (LEVA)	B1014.	115	1	HSB/LH(ON CABIN FLR)	4.2	221.0	-18.3	53.0
GLOVES, EV (PAIR)-CDR.	B1015.	115	1	HSB/LH(ON CABIN FLR)	2.6	221.0	-18.3	53.0
KIT, EMU MAINTENANCE	B1016.	115	1	HSB/LH(ON CABIN FLR)	.5	221.0	-18.3	53.0
PURGE VALVE ASSY-CDR.	B1017.	115	1	LUNAR OVERSHOES-UPR	.5	280.8	-20.0	-9.5
PURGE VALVE ASSY-LMP.	B1017.	115	1	LUNAR OVERSHOES-LWR	.5	273.8	-20.0	-9.5
LIFE LINE (LIGHT WEIGHT)	B1020.4	115	1	BAG ASY, LEC+WT(LHSSC)	.3	235.0	-34.0	45.0
BAG, DEPLOY. LIFE LINE	B1020.5	115	1	BAG ASY, LEC+WT(LHSSC)	.1	235.0	-34.0	45.0
TETHER, WAIST EVA	B1020.6	115	1	BAG ASY, LEC+WT(LHSSC)	.5	235.0	-34.0	45.0
TETHER, WAIST EVA	B1020.7	115	1	BAG ASY, LEC+WT(LHSSC)	.5	235.0	-34.0	45.0
STRAPS, ATTACH, PLSS, LOWER (LH)	B1021.	115	2	ON CDR PLSS(RECHG ST	.4	262.8	-20.8	15.4
STRAPS, ATTACH, PLSS, LOWER (RH)	B1022.	115	2	ON LMP PLSS(CBN. FLR)	.6	219.7	.0	44.7
LUNAR EVA VISOR (LEVA)	B1014.	115	1	HSB/LH(ON CABIN FLR)	4.2	221.0	-18.3	53.0
HELMET STOWAGE BAG-LMP.	B1058.	111	1	ON CABIN FLOOR	1.4	221.0	-18.3	53.0
GLOVES, EV (PAIR)	B1057.	111	1	HSB/LH(JN CABIN FLR)	2.2	221.0	-18.3	53.0
BAG, 70MM MAG. 1LM XFR)	06430.	111	1	RH SIDE STOW. CUMPT.	.5	238.4	38.6	46.0
LM EQUIP. RELOC. 2					94.20	253.49	-17.81	8.04

NOTE: Further information relating to this table is given on pages 3.4-19, 3.4-20 and 3.4-21.

Table 3.4-9.2 (Continued)

MISSION H-3 TRANSFERRED CREW AND EQUIPMENT STOWAGE LIST								
ITEMS REARRANGED IN LM PRIOR TO LUNAR LIFT-OFF (14)								
LM COORDINATES								
DESCRIPTION	STOW. ITEM	REF	NO.	STOWAGE LOCATION	WEIGHT	X-C.G.	Y-C.G.	Z-C.G.
MAGAZINE, 16MM DATA ACQUISITION	A0101.1	111	1	XFR BAG (ISA/OASE)	1.0	260.0	.0	2.2
MAGAZINE, 70MM L.S. HASSELBLAD	A0108.1	111	2	ISA (OVER AS ENG CVR)	2.8	280.0	.0	-10.0
OXYGEN PURGE SYS (OPS)-CDR.	B1012.	115	1	ON CABIN FLOOR-OPS	35.0	219.7	.0	44.7
OXYGEN PURGE SYS (OPS)-LMP.	B1012.	115	1	ON CABIN FLOOR-OPS	35.0	219.7	.0	44.7
HELMET STOWAGE BAG-CDR.	B1013.	115	1	HSB (ON ASC. ENG COVR)	1.4	260.0	-5.5	-1.5
LUNAR EVA VISOR (LEVA)	B1014.	115	1	HSB (ON ASC. ENG COVR)	4.2	260.0	-5.5	-1.5
GLOVES, EV (PAIR)-CDR.	B1015.	115	1	HSB (ON ASC. ENG COVR)	2.6	260.0	-5.5	-1.5
KIT, EMU MAINTENANCE	B1016.	115	1	HSB (ON ASC. ENG COVR)	.5	260.0	-5.5	-1.5
PURGE VALVE ASSY-CDR.	B1017.	115	1	RH SIDE STOW. COMPT.	.5	238.4	38.6	46.0
PURGE VALVE ASSY-LMP.	B1017.	115	1	RH SIDE STOW. COMPT.	.5	238.4	38.6	46.0
LIFE LINE (LIGHT WEIGHT)	B1020.4	115	1	LH SIDE STOW. COMPT.	.3	235.0	-34.0	45.0
BAG, DEPLOY. LIFE LINE	B1020.5	115	1	LH SIDE STOW. COMPT.	.1	235.0	-34.0	45.0
TETHER, WAIST EVA	B1020.6	115	1	LH SIDE STOW. COMPT.	.5	235.0	-34.0	45.0
TETHER, WAIST EVA	B1020.7	115	1	LH SIDE STOW. COMPT.	.5	235.0	-34.0	45.0
STRAPS, ATTACH, PLSS, LOWER (LH)	B1021.	115	2	RH SIDE STOW. COMPT.	.4	238.4	38.6	46.0
STRAPS, ATTACH, PLSS, LOWER (RH)	B1022.	115	2	RH SIDE STOW. COMPT.	.6	238.4	38.6	46.0
LUNAR EVA VISOR (LEVA)	B1014.	115	1	HSB (ON ASC. ENG COVR)	4.2	260.0	5.5	6.0
HELMET STOWAGE BAG-LMP.	B1058.	111	1	HSB (ON ASC. ENG COVR)	1.4	260.0	5.5	6.0
GLOVES, EV (PAIR)	B1057.	111	1	HSB (ON ASC. ENG COVR)	2.2	260.0	5.5	6.0
BAG, 70MM MAG. (LM XFR)	G6430.	111	1	ISA (OVER AS ENG CVR)	.5	280.0	.0	-10.0
LM EQUIP. RELOC. 2					94.20	229.92	.26	34.89

NOTE: Further information relating to this table is given on pages 3.4-19, 3.4-20 and 3.4-21.

Amendment 92
12/4/70

Table 3.4-9.2 (Continued)

MISSION H-3 TRANSFERRED CREW AND EQUIPMENT STORAGE LIST								
ITEMS TRANSFERRED FROM ASC. STAGE INTO CM PRIOR TO ASG. STAGE JETTISON (15)								
LN COORDINATES								
DESCRIPTION	STOW. ITEM	REF	NO.	STORAGE LOCATION	WEIGHT	X-C.G.	Y-C.G.	Z-C.G.
CREW-COMMANDER (CDR)	TBD	227	1	LH CREW STATION-	171.0	260.0	-22.0	45.0
CREW-LM PILOT (LMP)	TBD	227	1	RH CREW STATION-	185.0	260.0	22.0	45.0
TORSO+LMB SUIT ASSY, EV-CDR.	80200.1	127	1	ON CREW(LH CREW STA)	39.3	260.0	-22.0	45.0
HELMET ASSY, PRESSURE-CDR.	80200.2	127	1	ON CREW(LH CREW STA)	2.5	260.0	-22.0	45.0
GLOVES, IV(PAIR)-CDR.	80200.3	127	1	ON CREW(LH CREW STA)	1.7	260.0	-22.0	45.0
COMMUNICATION CARRIER-CDR.	80200.4	127	1	ON CREW(LH CREW STA)	1.6	260.0	-22.0	45.0
POCKET,CHECKLIST+SCISSORS-CDR.	80200.5	167	1	ON PGA-CJ(R)ON CREW)	.2	250.6	-22.0	43.4
POCKET,CHECKLIST-CDR.	80200.6	167	1	ON PGA-CJ(R)ON CREW)	.2	250.6	-22.0	43.4
UCTA-CDR.	80205.	117	1	ON CREW(LH CREW STA)	.5	260.0	-22.0	45.0
BIOINSTRUMENTATION-CDR.	80203.	111	1	ON CREW(LH CREW STA)	1.1	260.0	-22.0	45.0
GARMENT, LIQUID COOLING - CDR.	80107.	111	1	ON CREW(LH CREW STA)	5.0	260.0	-22.0	45.0
EARPIECE, MOLDED COM. CARRI-CDR.	80200.1	111	1	ON CREW(LH CREW STA)	NEGL	260.0	-22.0	45.0
EARTUBE(COM. CARRIER)-CDR.	80200.2	111	1	ON CREW(LH CREW STA)	NEGL	260.0	-22.0	45.0
SUNGLASSES-CDR.	A0200.	117	1	ON CREW(LH CREW STA)	.1	260.0	-22.0	45.0
POUCH, SUNGLASSES-CDR.	A0201.	117	1	ON CREW(LH CREW STA)	NEGL	260.0	-22.0	45.0
CHRONOGRAPH-CDR.	A0202.	117	1	ON CREW(LH CREW STA)	.1	260.0	-22.0	45.0
WATCHBAND-CDR.	A0203.	117	1	ON CREW(LH CREW STA)	NEGL	260.0	-22.0	45.0
PENS, DATA RECORDING-CDR.	A0204.	117	1	ON CREW(LH CREW STA)	.1	260.0	-22.0	45.0
PEN, MARKER-CDR.	A0205.	117	1	ON CREW(LH CREW STA)	NEGL	260.0	-22.0	45.0
PENCIL-CDR.	A0206.	117	1	ON CREW(LH CREW STA)	.1	260.0	-22.0	45.0
PENLIGHTS-CDR	80206.	117	1	ON CREW(LH CREW STA)	.3	260.0	-22.0	45.0
BIOBELT ASSY-CDR.	80207.	117	1	ON CREW(LH CREW STA)	.2	260.0	-22.0	45.0
DOSIMETER, PERSONAL-CDR.	80200.	117	1	ON CREW(LH CREW STA)	.4	260.0	-22.0	45.0
DOSIMETER, PASSIVE-CDR.	80201.	117	1	ON CREW(LH CREW STA)	NEGL	260.0	-22.0	45.0
TORSO+LMB SUIT ASSY, EV-LMP.	80200.1	127	1	ON CREW(RH CREW STA)	39.3	260.0	22.0	45.0
HELMET ASSY, PRESSURE-LMP.	80200.2	127	1	ON CREW(RH CREW STA)	2.5	260.0	22.0	45.0
GLOVES, IV(PAIR)-LMP.	80200.7	127	1	ON CREW(RH CREW STA)	1.6	260.0	22.0	45.0
COMMUNICATIONS CARRIER-LMP.	80200.4	127	1	ON CREW(RH CREW STA)	1.6	260.0	22.0	45.0
POCKET,CHECKLIST+SCISSORS-LMP.	80200.5	167	1	ON PGA-LMP(ON CREW)	.2	250.6	22.0	43.4
POCKET,CHECKLIST-LMP.	80200.6	167	1	ON PGA-LMP(ON CREW)	.2	250.6	22.0	43.4
UCTA-LMP.	80205.	117	1	ON CREW(RH CREW STA)	.5	260.0	22.0	45.0
BIOINSTRUMENTATION-LMP.	80203.	111	1	ON CREW(RH CREW STA)	1.1	260.0	22.0	45.0

NOTE: Further information relating to this table is given on pages 3.4-19, 3.4-20 and 3.4-21.

Table 3.4-9.2 (Continued)

MISSION H-3 TRANSFERRED CREW AND EQUIPMENT STORAGE LIST								
ITEMS TRANSFERRED FROM ASC. STAGE INTO CM PRIOR TO ASC. STAGE JETTISON (15)								
LM COORDINATES								
DESCRIPTION	STOW. ITEM	REF	NO.	STOWAGE LOCATION	WEIGHT	X-C.G.	Y-C.G.	Z-C.G.
GARMENT, LIQUID COOLING - LMP.	B0107.	111	1	ON CREW(RH CREW STA)	5.0	260.0	22.0	45.0
EARPIECE, MCLDEDICUM. CARR. LMP.	E0200.1	111	1	ON CREW(RH CREW STA)	NEGL	260.0	22.0	45.0
EARTUBE(COMM. CARFIER)-LMP.	E0200.2	111	1	ON CREW(RH CREW STA)	NEGL	260.0	22.0	45.0
SUNGLASSES-LMP.	A0200.	117	1	ON CREW(RH CREW STA)	.1	260.0	22.0	45.0
POUCH, SUNGLASSES-LMP.	A0201.	117	1	ON CREW(RH CREW STA)	NEGL	260.0	22.0	45.0
CHRONOGRAPH-LMP.	A0202.	117	1	ON CREW(RH CREW STA)	.1	260.0	22.0	45.0
WATCHBAND-LMP.	A0203.	117	1	ON CREW(RH CREW STA)	NEGL	260.0	22.0	45.0
PENS, DATA RECORDING-LMP.	A0204.	117	1	ON CREW(RH CREW STA)	.1	260.0	22.0	45.0
PENS, MARKER-LMP.	A0205.	117	1	ON CREW(RH CREW STA)	NEGL	260.0	22.0	45.0
PENCIL-LMP.	A0206.	117	1	ON CREW(RH CREW STA)	.1	260.0	22.0	45.0
PENLIGHTS-LMP.	B0206.	117	1	ON CREW(RH CREW STA)	.3	260.0	22.0	45.0
BIOBELT ASSY-LMP.	B0207.	117	1	ON CREW(RH CREW STA)	.2	260.0	22.0	45.0
DOSIMETER, PERSONAL-LMP.	D0200.	117	1	ON CREW(RH CREW STA)	.4	260.0	22.0	45.0
DOSIMETER, PASSIVE-LMP.	D0201.	117	1	ON CREW(RH CREW STA)	NEGL	260.0	22.0	45.0
LM ACTIVATION CHECKLIST	A0114.12	114	1	LM XFR DATA CARD KIT	.5	280.8	-20.0	14.0
LM L.S. CHECKLIST	A0114.10	114	1	LM XFR DATA CARD KIT	1.0	280.8	-20.0	14.0
LM SYSTEMS ACTIVATION CHECKLIST	A0114.12	114	1	LM XFR DATA CARD KIT	.5	280.8	-20.0	14.0
LM TIMELINE BOOK	A0114.14	114	1	LM XFR DATA CARD KIT	.5	280.8	-20.0	14.0
LM XFR DATA CARD KIT	A0114.18	114	1	FLIGHT DATA FILE CTR	.6	280.8	-20.0	14.0
LM DATA CARD BOOK	A0114.19	114	1	LM XFR DATA CARD KIT	.3	280.8	-20.0	14.0
LM ORBIT MONITOR CHART	A0114.22	114	1	LM XFR DATA CARD KIT	.3	280.8	-20.0	14.0
DOSIMETER, PASSIVE RADIATION	D0101.	111	1	16MM MAG BAG(RHSSC)	NEGL	238.4	38.6	46.0
SCISSORS	B0204.	111	1	ON CREW(LH CREW STA)	.5	260.0	-22.0	45.0
BAG, STOW+XFR, 16MM MAG.	O0380.	111	1	RH SIDE STOW.COMPT.	.3	238.4	38.6	46.0
BAG, 70 MM MAG(LM XFR)	O0391.	111	1	RH SIDE STOW.COMPT.	.5	238.4	38.6	46.0
MAGAZINE, 16MM DATA ACQUISITION	A0101.1	111	1	XFR BAG(ISA/OASE)	1.0	260.0	.0	2.2
MAGAZINE, 16MM DATA ACQUISITION	A0101.1	111	1	XFR BAG(ISA/OASE)	1.0	260.0	.0	2.2
MAGAZINE, 16MM DATA ACQUISITION	A0101.1	111	6	XFR BAG(RHSSC)	6.0	238.4	38.6	46.0
BAG, STOW+XFR, 16MM MAG.	O6393.	111	1	ISA(OVER AS ENG CVR)	.1	280.0	.0	-10.0
MAGAZINE, 70 MM L.S. HASSEL.	A0108.1	111	3	RH SIDE STOW.COMPT.	4.2	238.4	38.6	46.0
MAGAZINE, 70MM L.S. HASSELBLAD	A0108.1	111	2	RH SIDE STOW.COMPT.	2.8	238.4	38.6	46.0
SUBSYSTEM, FECAL CONTAINMENT-CDR	B0113.	117	1	ON CREW(LH CREW STA)	.3	260.0	-22.0	45.0

NOTE: Further information relating to this table is given on pages 3.4-19, 3.4-20 and 3.4-21.

Table 3.4-9.2 (Continued)

MISSION H-3 TRANSFERRED CREW AND EQUIPMENT STOWAGE LIST								
ITEMS TRANSFERRED FROM ASC. STAGE INTO CM PRIOR TO ASC. STAGE JETTISON (15)								
LM COORDINATES								
DESCRIPTION	STOW. ITEM	REF	NO.	STOWAGE LOCATION	WEIGHT	X-C.G.	Y-C.G.	Z-C.G.
SUBSYSTEM, FECAL CONTAINMENT-LMP	B0113.	117	1	UN CREW(RH CREW STA)	.3	260.0	22.0	45.0
INTERIM STOW. ASSY (ISA)	U3007.	114	* 1	OVER AS ENG. COVER	7.6	260.0	.0	2.2
BRACKET, CAMERA MOUNT	B1001.1	115	1	IN RRKT. BG (ISA/OASE)	.6	260.0	.0	2.2
BAG, STOWAGE, THERMAL SAMPLES	B1060.	111	2	ISA(OVER AS ENG CVR)	.2	280.0	.0	-10.0
SAMPLES, THERMAL COAT. DEGRADE	F1002.	111	2	ISA(OVER AS ENG CVR)	.8	280.0	.0	-10.0
CAMERA, LS ELECT. HASSELBLAD	A1015.	115	1	RH SIDE STOW.COMPT.	3.1	238.4	38.6	46.0
LENS, 60 MM	A1016.	115	1	RH SIDE STOW.COMPT.	1.8	238.4	38.6	46.0
TRIGGER, ELECT. HASSELBLAD CAMERA	A1027.	115	1	RH SIDE STOW.COMPT.	.2	238.4	38.6	46.0
HANDLE, ELECT. HASSELBLAD CAMERA	A1028.	115	1	RH SIDE STOW.COMPT.	.5	238.4	38.6	46.0
SAMPLE CONTAINER, MAGNETIC SHLO	G4039.	111	1	ISA(OVER AS ENG CVR)	1.0	280.0	.0	-10.0
SAMPLE CONT., SPECIAL ENVIRON.	G4040.	111	1	LH SIDE STOW.COMPT.	1.0	235.0	-34.0	45.0
CONTR. SAMPL. RET. NO. 1 (LOADED)	G4003.	115	1	SRC RACK NO.1-LWR.	65.0	257.4	-20.7	-6.0
CONTR. SAMPL. RET. NO. 2 (LOADED)	G4004.	115	1	SRC RACK NO.2-UPR.	65.0	265.9	-20.7	-6.0
S.W.C. EXPERIMENT	G4011.	115	1	ISA(OVER AS ENG CVR)	.3	280.0	.0	-10.0
CONTR. CONT. SMPL. RETRN (LOADED)	G4016.	115	1	ISA(OVER AS ENG CVR)	2.6	280.0	.0	-10.0
LM LUNAR SURFACE MAPS	A1008.5	111	1	FLIGHT DATA FILE CTR	1.7	280.8	-20.0	14.0
CASSETTE, CLOSE-UP CAMERA (CSC)	J1001.	115	1	ISA(OVER AS ENG CVR)	.5	280.0	.0	-10.0
LM RENDEZVOUS CHARTS	A1008.6	111	1	FLIGHT DATA FILE CTR	.5	280.8	-20.0	14.0
KIT, PILOTS PREFERENCE (PPK)	A1007.	115	2	RH SIDE STOW.COMPT.	1.0	238.4	38.6	46.0
KIT, PILOTS PREFERENCE (PPK)	A1007.	115	1	LH SIDE STOW.COMPT.	.5	235.0	-34.0	45.0
FLAG KIT, STANDARD	N1002.	166	1	LH SIDE STOW.COMPT.	.9	235.0	-34.0	45.0
D.S.E.A.	O3005.	115	1	UN PLUS 227 BMD	2.3	260.0	-37.0	28.0
BAG, SAMPLE RETURN	O3060.	111	1	UN PLUS 227 BMD	35.0	260.0	-37.0	28.0
BAG, 70MM MAG. (LM XFR)	O6430.	111	1	ISA(OVER AS ENG CVR)	.5	280.0	.0	-10.0
BAG, LUNAR EQUIPMENT TRANSFER	O3018.	111	1	ISA(OVER AS ENG CVR)	.9	280.0	.0	-10.0
BAG, SOLAR WIND COMP. EXP.	G4011.1	111	1	ISA(OVER AS ENG CVR)	T80	280.0	.0	-10.0
WEIGH BAG WITH FOOTBALL SIZ RK	G4018.	111	1	LH SIDE STOW.COMPT.	30.0	235.0	-34.0	45.0
WEIGH BAG WITH FOOTBALL SIZ RK	G4018.	111	1	ISA(OVER AS ENG CVR)	30.0	280.0	.0	-10.0
WEIGH BAG WITH SMALL ROCKS	G4018.	111	1	ISA(OVER AS ENG CVR)	15.0	280.0	.0	-10.0
2 CREW+EQUIP, LM-CM					751.91	260.16	-5.60	30.74

NOTE: Further information relating to this table is given on pages 3.4-19, 3.4-20 and 3.4-21.

Table 3.4-9.2 (Continued)

MISSION H-3 TRANSFERRED CREW AND EQUIPMENT STOWAGE LIST								
ITEMS TRANSFERRED FROM ASC. STAGE INTO CM PRIOR TO ASC. STAGE JETTISON (16)								
APOLLO COORDINATES								
DESCRIPTION	STOW. ITEM	REF	QU.	STOWAGE LOCATION	WEIGHT	X-C.G.	Y-C.G.	Z-C.G.
CREW-COMMANDER (CDR)	T8D	227	1	ON COUCH(CTR CREW STA	171.0	1043.0	.0	-10.4
CREW-LM PILOT (LMP)	T8D	227	1	ON COUCH(RH CREW STA	185.0	1043.0	24.5	-10.4
TORSO+LIMB SUIT ASSY, EV-CDR.	80200.1	127	1	ON CREW-CDR(CTR. STA)	39.3	1043.0	.0	-10.4
HELMET ASSY, PRESSURE-CDR.	80200.2	127	1	ON CREW-CDR(CTR. STA)	2.5	1043.0	.0	-10.4
GLOVES, IV(PAIR)-CDR.	80200.3	127	1	ON CREW-CDR(CTR. STA)	1.7	1043.0	.0	-10.4
COMMUNICATION CARRIER-CDR.	80200.4	127	1	ON CREW-CDR(CTR. STA)	1.6	1043.0	.0	-10.4
POCKET, CHECKLIST+SCISSORS-CDR.	80200.5	167	1	ON PGA (CREW-CTR STA)	.2	1043.0	.0	-10.4
POCKET, CHECKLIST-CDR.	80200.6	167	1	ON PGA (CREW-CTR STA)	.2	1043.0	.0	-10.4
UCTA-CDR.	80205.	117	1	ON CREW-CDR(CTR. STA)	.5	1043.0	.0	-10.4
BIOINSTRUMENTATION-CDR.	80203.	111	1	ON CREW-CDR(CTR. STA)	1.1	1043.0	.0	-10.4
GARMENT, LIQUID COOLING - CDR.	80107.	111	1	ON CREW-CDR(CTR. STA)	5.0	1043.0	.0	-10.4
EARPIECE, MOLDED (COM. CARR)-CDR.	80200.1	111	1	ON CREW-CDR(CTR. STA)	NEGL	1043.0	.0	-10.4
EARTUBE (COM. CARRIER)-CDR.	80200.2	111	1	ON CREW-CDR(CTR. STA)	NEGL	1043.0	.0	-10.4
SUNGLASSES-CDR.	A0200.	117	1	ON CREW-CDR(CTR. STA)	.1	1043.0	.0	-10.4
POUCH, SUNGLASSES-CUP.	A0201.	117	1	ON CREW-CDR(CTR. STA)	NEGL	1043.0	.0	-10.4
CHRONOGRAPH-CDR.	A0202.	117	1	ON CREW-CDR(CTR. STA)	.1	1043.0	.0	-10.4
WATCHBAND-CDR.	A0203.	117	1	ON CREW-CDR(CTR. STA)	NEGL	1043.0	.0	-10.4
PENS, DATA RECORDING-CDR.	A0204.	117	1	ON CREW-CDR(CTR. STA)	.1	1043.0	.0	-10.4
PEN, MARKER-CDR.	A0205.	117	1	ON CREW-CDR(CTR. STA)	NEGL	1043.0	.0	-10.4
PENCIL-CDR.	A0206.	117	1	ON CREW-CDR(CTR. STA)	.1	1043.0	.0	-10.4
PENLIGHTS-CDR.	B0206.	117	1	ON CREW-CDR(CTR. STA)	.3	1043.0	.0	-10.4
BIOBELT ASSY-CDR.	80207.	117	1	ON CREW-CDR(CTR. STA)	.2	1043.0	.0	-10.4
DOSIMETER, PERSONAL-CDR.	D0200.	117	1	ON CREW-CDR(CTR. STA)	.4	1043.0	.0	-10.4
DOSIMETER, PASSIVE-CDR.	D0201.	117	1	ON CREW-CDR(CTR. STA)	NEGL	1043.0	.0	-10.4
TORSO+LIMB SUIT ASSY, EV-LMP.	80200.1	127	1	ON CREW-LMP(RH STA)	39.3	1043.0	24.5	-10.4
HELMET ASSY, PRESSURE-LMP.	80200.2	127	1	ON CREW-LMP(RH STA)	2.5	1043.0	24.5	-10.4
GLOVES, IV(PAIR)-LMP.	80200.7	127	1	ON CREW-LMP(RH STA)	1.6	1043.0	24.5	-10.4
COMMUNICATIONS CARRIER-LMP.	80200.4	127	1	ON CREW-LMP(RH STA)	1.6	1043.0	24.5	-10.4
POCKET, CHECKLIST+SCISSORS-LMP.	80200.5	167	1	ON PGA (CREW-RH STA)	.2	1043.0	24.5	-10.4
POCKET, CHECKLIST-LMP.	80200.6	167	1	ON PGA (CREW-RH STA)	.2	1043.0	24.5	-10.4
UCTA-LMP.	80205.	117	1	ON CREW-LMP(RH STA)	.5	1043.0	24.5	-10.4
BIOINSTRUMENTATION-LMP.	80203.	111	1	ON CREW-LMP(RH STA)	1.1	1043.0	24.5	-10.4

NOTE: Further information relating to this table is given on pages 3.4-19, 3.4-20 and 3.4-21.

Table 3.4-9.2 (Continued)

MISSION H-3 TRANSFERRED CREW AND EQUIPMENT STOWAGE LIST								
ITEMS TRANSFERRED FROM ASC. STAGE INTO CM PRIOR TO ASC. STAGE JETTISON (16)								
APOLLO COORDINATES								
DESCRIPTION	STOW. ITEM	REF	NO.	STOWAGE LOCATION	WEIGHT	X-C.G.	Y-C.G.	Z-C.G.
GARMENT, LIQUID COOLING - LMP.	B0107.	111	1	ON CREW-LMP(RH STA)	5.0	1043.0	24.5	-10.4
EARPIECE, MOLDED (COM. CARR.) LMP.	E0200.1	111	1	ON CREW-LMP(RH STA)	NEGL	1043.0	24.5	-10.4
EARTUBE (COMM. CARRIER)-LMP.	E0200.2	111	1	ON CREW-LMP(RH STA)	NEGL	1043.0	24.5	-10.4
SUNGLASSES-LMP.	A0200.	117	1	ON CREW-LMP(RH STA)	.1	1043.0	24.5	-10.4
POUCH, SUNGLASSES-LMP.	A0201.	117	1	ON CREW-LMP(RH STA)	NEGL	1043.0	24.5	-10.4
CHRONOGRAPH-LMP.	A0202.	117	1	ON CREW-LMP(RH STA)	.1	1043.0	24.5	-10.4
MATCHBAND-LMP.	A0203.	117	1	ON CREW-LMP(RH STA)	NEGL	1043.0	24.5	-10.4
PENS, DATA RECORDING-LMP.	A0204.	117	1	ON CREW-LMP(RH STA)	.1	1043.0	24.5	-10.4
PENS, MARKER-LMP.	A0205.	117	1	ON CREW-LMP(RH STA)	NEGL	1043.0	24.5	-10.4
PENCIL-LMP.	A0206.	117	1	ON CREW-LMP(RH STA)	.1	1043.0	24.5	-10.4
PENLIGHTS-LMP.	B0206.	117	1	ON CREW-LMP(RH STA)	.3	1043.0	24.5	-10.4
BIOBELT ASSY-LMP.	B0207.	117	1	ON CREW-LMP(RH STA)	.2	1043.0	24.5	-10.4
DOSIMETER, PERSONAL-LMP.	D0200.	117	1	ON CREW-LMP(RH STA)	.4	1043.0	24.5	-10.4
DOSIMETER, PASSIVE-LMP.	D0201.	117	1	ON CREW-LMP(RH STA)	NEGL	1043.0	24.5	-10.4
LM ACTIVATION CHECKLIST	A0114.12	114	1	IN FDF (R3)	.5	1072.0	26.0	9.0
LM L.S. CHECKLIST	A0114.10	114	1	IN FDF (R3)	1.0	1072.0	26.0	9.0
LM SYSTEMS ACTIVATION CHECKLIST	A0114.12	114	1	IN FDF (R3)	.5	1072.0	26.0	9.0
LM TIMELINE BOOK	A0114.14	114	1	IN FDF (R3)	.5	1072.0	26.0	9.0
LM XFR DATA CARD KIT	A0114.18	114	1	IN FDF (R3)	.6	1072.0	26.0	9.0
LM DATA CARD BOOK	A0114.19	114	1	IN FDF (R3)	.3	1072.0	26.0	9.0
LM ORBIT MONITOR CHART	A0114.22	114	1	IN FDF (R3)	.3	1072.0	26.0	9.0
DOSIMETER, PASSIVE RADIATION	D0101.	111	1	16MM MAG BAG (R13)	NEGL	1024.0	45.0	-26.0
SCISSORS	B0204.	111	1	ON CREW-COR(CTR. STA)	.5	1043.0	.0	-10.4
BAG, STOW+XFR, 16MM MAG.	00380.	111	1	AREA R13	.3	1024.0	45.0	-26.0
BAG, 70 MM MAG (LM XFR)	00381.	111	1	APEA R13	.5	1024.0	45.0	-26.0
MAGAZINE, 16MM DATA ACQUISITION	A0101.1	111	1	XFR+STOW BG, 16MM(B1)	1.0	1050.0	-27.0	39.0
MAGAZINE, 16MM DATA ACQUISITION	AC101.1	111	1	XFR+STOW BG, 16MM(B1)	1.0	1050.0	-27.0	39.0
MAGAZINE, 16MM DATA ACQUISITION	A0101.1	111	6	XFR BG/DECON. BG(R13)	6.0	1024.0	45.0	-26.0
BAG, STOW+XFR, 16MM MAG.	06393.	111	1	AREA B1	.1	1050.0	-27.0	39.0
MAGAZINE, 70 MM L.S. HASSEL.	A0108.1	111	3	AREA R13	4.2	1024.0	45.0	-26.0
MAGAZINE, 70MM L.S. HASSELBLAD	A0109.1	111	2	XFR BG/DECON. BG(R13)	2.8	1024.0	45.0	-26.0
SUBSYSTEM, FECAL CONTAINMENT-CDR	B0113.	117	1	ON CREW-COR(CTR. STA)	.3	1043.0	.0	-10.4

NOTE: Further information relating to this table is given on pages 3.4-19, 3.4-20 and 3.4-21.

Table 3.4-9.2 (Continued)

MISSION H-3 TRANSFERRED CREW AND EQUIPMENT STOWAGE LIST								
ITEMS TRANSFERRED FROM ASC. STAGE INTJ CM PRIOR TO ASC. STAGE JETTISON (16)								
APULLO COORDINATES								
DESCRIPTION	STOW. ITEM	REF	NO.	STOWAGE LOCATION	WEIGHT	X-C.G.	Y-C.G.	Z-C.G.
SUBSYSTEM, FECAL CONTAINMNT-LMP	B0113.	117	1	ON CREW-LMP(RH STA)	.3	1043.0	24.5	-10.4
INTERIM STOW. ASSY (ISA)	U3007.	114	* 1	IN DECONT.BG (ON A1)	7.6	1012.0	-22.0	-26.0
BRACKET, CAMERA MOUNT	B1001.1	115	1	ISA (DECON.BG/ON A1)	.6	1012.0	-22.0	-26.0
BAG, STOWAGE, THERMAL SAMPLES	B1060.	111	2	IN DECONT.BG (ON A1)	.2	1012.0	-22.0	-26.0
SAMPLES, THERMAL COAT. DEGRADE	F1002.	111	2	IN DECONT.BG (ON A1)	.8	1012.0	-22.0	-26.0
CAMERA, LS ELECT. HASSELBLAD	A1015.	115	1	ISA (DECON.BG/ON A1)	3.1	1012.0	-22.0	-26.0
LENS, 60 MM	A1016.	115	1	AREA A1	1.8	1012.0	-22.0	-26.0
TRIGGER, ELECT. HASSELBLAD CAMRA	A1027.	115	1	ISA (DECON.BG/ON A1)	.2	1012.0	-22.0	-26.0
HANDLE, ELECT. HASSELBLAD CAMERA	A1028.	115	1	ISA (DECON.BG/ON A1)	.5	1012.0	-22.0	-26.0
SAMPLE CONTAINER, MAGNETIC SHLD	G4039.	111	1	ISA (DECON.BG/ON A1)	1.0	1012.0	-22.0	-26.0
SAMPLE CONT., SPECIAL ENVIRON.	G4040.	111	1	ISA (DECON.BG/ON A1)	1.0	1012.0	-22.0	-26.0
CONTNR. SAMPL. RET. NO. 1 (LOADED)	G4003.	115	1	AREA B5	65.0	1031.0	-8.0	39.0
CONTNR. SAMPL. RET. NO. 2 (LOADED)	G4004.	115	1	AREA B6	65.0	1031.0	13.0	39.0
S.W.C. EXPERIMENT	G4011.	115	1	ISA (DECON.BG/ON A1)	.3	1012.0	-22.0	-26.0
CONTR. CONT. SMPL. RETRN (LOADED)	G4016.	115	1	BAG, RETURN EQUIP (B1)	2.6	1050.0	-27.0	39.0
LM LUNAR SURFACE MAPS	A1008.5	111	1	VOLUME CENTROID CM	1.7	1040.6	.0	.0
CASSETTE, CLOSE-UP CAMERA (CSC)	J1001.	115	1	BAG, RETURN EQUIP (B1)	.5	1050.0	-27.0	39.0
LM RENDEZVOUS CHARTS	A1008.6	111	1	VOLUME CENTROID CM	.5	1040.6	.0	.0
KIT, PILOTS PREFERENCE (PPK)	A1007.	115	2	AREA R13	1.0	1024.0	45.0	-26.0
KIT, PILOTS PREFERENCE (PPK)	A1007.	115	1	CABN FN FLTR BG (A13)	.5	1010.0	-22.0	-2.0
FLAG KIT, STANDARD	N1002.	166	1	CABN FN FLTR BG (A13)	.9	1010.0	-22.0	-2.0
D.S.E.A.	O3005.	115	1	AREA R13	2.3	1024.0	45.0	-26.0
BAG, SAMPLE RETURN	O3060.	111	1	ON CONTAINER A10	35.0	1011.0	23.0	6.0
BAG, 70MM MAG. (LM XF4)	O6430.	111	1	AREA R13	.5	1024.0	45.0	-26.0
BAG, LUNAR EQUIPMENT TRANSFER	U3019.	111	1	ISA (DECON.BG/ON A1)	.9	1012.0	-22.0	-26.0
BAG, SOLAR WIND CUMP. EXP.	G4011.1	111	1	AREA A1	T80	1012.0	-22.0	-26.0
WEIGH BAG WITH FOOTBALL SIZ RK	G4019.	111	1	AREA A13	30.0	1010.0	-22.0	-2.0
WEIGH BAG WITH FOOTBALL SIZ RK	G4018.	111	1	ISA (DECON.BG/ON A1)	30.0	1012.0	-22.0	-26.0
WEIGH BAG WITH SMALL ROCKS	G4018.	111	1	ISA (DECON.BG/ON A1)	15.0	1012.0	-22.0	-26.0
2 CREW+EQUIP, LM-CM					751.91	1035.20	7.51	-1.95

NOTE: Further information relating to this table is given on pages 3.4-19, 3.4-20 and 3.4-21.

Table 3.4-9.2 (Continued)

MISSION H-3 TRANSFERRED CREW AND EQUIPMENT STOWAGE LIST								
ITEMS TRANSFERRED FROM CM INTO ASC. STAGE PRIOR TO ASC. STAGE JETTISON (17)								
APOLLO COORDINATES								
DESCRIPTION	STOW. ITEM	REF	NO.	STOWAGE LOCATION	WEIGHT	X-C.G.	Y-C.G.	Z-C.G.
CSM/LM UMBILICAL	T80	222	1	UNDER RH COUCH	1.1	1018.0	24.5	-15.0
BRUSH, VACUUM	B0139.	111	1	IN BAG (UN AB)	.4	1018.0	22.0	-23.0
HOSE, VACUUM	Oe332.	111	1	VAC. HOSE BG (SIDE AB)	2.3	1012.0	22.0	-23.0
BAG, JETTISON STOWAGE	B0147.	111	1	AREA R13	.9	1024.0	45.0	-26.0
CO2 ABSORBERS (USED)	00327.	121	4	AREA B5	26.8	1031.0	-8.0	39.0
CO2 ABSORBERS (USED)	00327.	121	4	AREA B6	26.8	1031.0	13.0	39.0
SHIM, CO2 ABSORBERS (USED)	00328.	161	4	AREA B5	.8	1031.0	-8.0	39.0
SHIM, CO2 ABSORBERS (USED)	00328.	161	4	AREA B6	.8	1031.0	13.0	39.0
CONTAINER, B5	00342.	111	1	AREA B5	14.5	1031.0	-8.0	39.0
CONTAINER, B6	00343.	111	1	AREA B6	14.5	1031.0	13.0	39.0
DOCKING MECHANISM AND PROBE	00349.	222	1	IN CM TUNNEL	193.5	1110.3	.0	.0
COUPL. ASY, PGA O2 UMB. INTERCON.	00351.	116	1	AREA A1	.4	1012.0	-22.0	-26.0
BAG CAMERA - HATCH BRKT NDDW	06437.	111	1	IN CM PGA CONTAINER	.3	1015.0	.0	-19.9
EQUIP. XFR. CM-LM					283.10	1084.91	1.16	11.18

NOTE: Further information relating to this table is given on pages 3.4-19, 3.4-20 and 3.4-21.

Table 3.4-9.2 (Continued)

MISSION H-3 TRANSFERRED CREW AND EQUIPMENT STOWAGE LIST								
ITEMS TRANSFERRED FROM CM INTO ASC. STAGE PRIOR TO ASC. STAGE JETTISON (18)								
LM COORDINATES								
DESCRIPTION	STOW. ITEM	REF	NO.	STOWAGE LOCATION	WEIGHT	X-C.G.	Y-C.G.	Z-C.G.
CSM/LM UMBILICAL	TBD	222	1	IN L4 TUNNEL	1.1	300.0	.0	.0
BRUSH, VACUUM	60139.	111	1	ON VACUUM HOSE	.4	233.0	-3.0	63.0
HOSE, VACUUM	06332.	111	1	IN CONTAIN./FWD HTCH	2.3	233.0	-3.0	63.0
BAG, JETTISON STOWAGE	80147.	111	1	UNDER LMSSC	.9	236.5	-35.0	46.0
CO2 ABSORBERS (USED)	00327.	121	4	SRC RACK NO.1-LWR.	26.8	257.4	-20.7	-6.0
CO2 ABSORBERS (USED)	00327.	121	4	SRC RACK NO.2-UPR.	26.8	265.9	-20.7	-6.0
SHIM, CO2 ABSORBERS (USED)	00328.	161	4	SRC RACK NO.1-LWR.	.8	257.4	-20.7	-6.0
SHIM CO2 ABSORBERS (USED)	00323.	161	4	SRC RACK NO.2-UPR.	.8	265.9	-20.7	-6.0
CONTAINER, B5	00342.	111	1	SRC RACK NO.1-LWR.	14.5	257.4	-20.7	-6.0
CONTAINER, B6	00343.	111	1	SRC RACK NO.2-UPR.	14.5	265.9	-20.7	-6.0
COUPL.ASY,PGA O2 UMB.INTERCON.	00351.	116	1	IN CONTAIN./FWD HTCH	.4	233.0	-3.0	63.0
DOCKING PROBE	00349.	222	1	ON CABIN FLOOR	81.8	221.0	18.3	53.0
DOCKING STRUCTURE	TBD	222	1	IN L4 TUNNEL	111.7	314.7	.0	.0
BAG CAMERA - HATCH BRKT NDOW	06437.	111	1	LM VOLUME CENTROID.	.3	254.0	.0	.0
EQUIP.XFR. CM-LM					283.10	270.58	-1.01	14.37

NOTE: Further information relating to this table is given on pages 3.4-19, 3.4-20 and 3.4-21.

Amendment 92
12/4/70

Table 3.4-9.2 (Continued)

MISSION H-3 TRANSFERRED CREW AND EQUIPMENT STOWAGE LIST								
ITEMS REARRANGED IN ASC. STAGE PRIOR TO ASC. STAGE JETTISON (19)								
DESCRIPTION	STOW. ITEM	REF	NO.	STOWAGE LOCATION	WEIGHT	LM COORDINATES		
						X-C.G.	Y-C.G.	Z-C.G.
DOCKING DROGUE	F1000.	112	1	IN LM TUNNEL	21.4	300.0	.0	.0
LM EQUIP.RELOC.3					21.40	300.00	.00	.00

NOTE: Further information relating to this table is given on pages 3.4-19, 3.4-20 and 3.4-21.

Table 3.4-9.2 (Continued)

MISSION H-3 TRANSFERRED CREW AND EQUIPMENT STOWAGE LIST								
ITEMS REARRANGED IN ASC. STAGE PRIOR TO ASC. STAGE JETTISON (20)								
LM COORDINATES								
DESCRIPTION	STOW. ITEM	REF	NO.	STOWAGE LOCATION	WEIGHT	X-C.G.	Y-C.G.	Z-C.G.
DOCKING DROGUE	F1000.	112	1	ON CABN FLOOR/DROGUE	21.4	218.5	-19.6	47.6
LM EQUIP.RELOC.3					21.40	218.50	-19.60	47.60

NOTE: Further information relating to this table is given on pages 3.4-19, 3.4-20 and 3.4-21.

Table 3.4-9.2 (Continued)

MISSION H-3 TRANSFERRED CREW AND EQUIPMENT STOWAGE LIST								
ITEMS REARRANGED IN CM POST A/S JETTISON (21)								
APOLLO COORDINATES								
DESCRIPTION	STUM. ITEM	REF	NO.	STOWAGE LOCATION	WEIGHT	X-C.G.	Y-C.G.	Z-C.G.
TORSO+LIMB SUIT ASSY,IV-CMP.	80201.1	127	1	ON CREW-CMP(LH STA)	30.5	1043.0	-24.5	-10.4
HELMET ASSY,PRESSURE-CMP.	80201.2	127	1	ON CREW-CMP(LH STA)	2.5	1043.0	-24.5	-10.4
GLOVES,IV(PAIR)-CMP.	80201.3	127	1	ON CREW-CMP(LH STA)	1.7	1043.0	-24.5	-10.4
COMMUNICATIONS CARRIER-CMP.	80201.4	127	1	ON CREW-CMP(LH STA)	1.6	1043.0	-24.5	-10.4
POCKET,CHECKLIST+SCISSORS-CMP.	80201.5	167	1	ON PGA (CREW-LH STA)	.2	1043.0	-24.5	-10.4
POCKET, CHECKLIST-CMP	80201.6	167	1	ON PGA (CREW-LH STA)	.2	1043.0	-24.5	-10.4
BAG, MOTION SICKNESS-CMP.	AU208.	111	1	ON PGA (CREW-LH STA)	.1	1043.0	-24.5	-10.4
UCTA-CMP.	80205.	117	1	ON PGA (CREW-LH STA)	.5	1043.0	-24.5	-10.4
T-ADAPTER,CWG-CMP.	80135.	111	1	IN ADAPTER BAG (AB)	.4	1012.0	22.0	-23.0
JACKET ASSY,ICG-CMP.	80112.1	111	1	IN CM PGA CONTAINER	1.8	1015.0	.0	-19.9
TROUSER ASSY,ICG-CMP.	80112.2	111	1	IN CM PGA CONTAINER	1.8	1015.0	.0	-19.9
BOOT,RIGHT,ICG-CMP.	80112.3	111	1	IN CM PGA CONTAINER	.4	1015.0	.0	-19.9
BOOT,LEFT,ICG-CMP.	80112.4	111	1	IN CM PGA CONTAINER	.4	1015.0	.0	-19.9
EARTUBE,UNIVERSAL-CMP.	E0105.1	111	1	ON ICG(PGA CONTAINER)	NEGL	1015.0	.0	-19.9
HEADSET,LIGHTWEIGHT-CMP.	E0104.	111	1	AREA A8	.4	1012.0	22.0	-23.0
SUBSYSTEM,FECAL CONTAINMNT-CMP	80113.	117	1	ON CREW-CMP(LH STA)	.3	1043.0	-24.5	-10.4
TORSO+LIMB SUIT ASSY,EV-CDR.	80200.1	127	1	ON CREW-CDR(CTR.STA)	39.3	1043.0	.0	-10.4
HELMET ASSY,PRESSURE-CDR.	80200.2	127	1	ON CREW-CDR(CTR.STA)	2.5	1043.0	.0	-10.4
GLOVES,IV(PAIR)-CDR.	80200.3	127	1	ON CREW-CDR(CTR.STA)	1.7	1043.0	.0	-10.4
COMMUNICATION CARRIER-CDR.	80200.4	127	1	ON CREW-CDR(CTR.STA)	1.6	1043.0	.0	-10.4
POCKET,CHECKLIST+SCISSORS-CDR.	80200.5	167	1	ON PGA(CREW-CTR STA)	.2	1043.0	.0	-10.4
POCKET,CHECKLIST-CDR.	80200.6	167	1	ON PGA(CREW-CTR STA)	.2	1043.0	.0	-10.4
T-ADAPTER,CWG-CDR.	80135.	111	1	IN ADAPTER BAG (AB)	.4	1012.0	22.0	-23.0
JACKET ASSY,ICG-CDR.	80112.1	111	1	IN CM PGA CONTAINER	1.8	1015.0	.0	-19.9
TROUSER ASSY,ICG-CDR.	80112.2	111	1	IN CM PGA CONTAINER	1.8	1015.0	.0	-19.9
BOOT,RIGHT,ICG-CDR.	80112.3	111	1	IN CM PGA CONTAINER	.4	1015.0	.0	-19.9
BOOT,LEFT,ICG-CDR.	80112.4	111	1	IN CM PGA CONTAINER	.4	1015.0	.0	-19.9
EARTUBE,UNIVERSAL-CDR.	E0105.	111	1	ON ICG(PGA CONTAINER)	NEGL	1015.0	.0	-19.9
HEADSET,LIGHTWEIGHT-CDR.	E0104.	111	1	AREA A8	.4	1012.0	22.0	-23.0
GARMENT,CONSTANT WEAR-CDR.	80208.	111	1	IN CM PGA CONTAINER	.8	1015.0	.0	-19.9
GARMENT,LIQUID COOLING - CDR.	80107.	111	1	ON CREW-CDR(CTR.STA)	5.0	1043.0	.0	-10.4
TORSO+LIMB SUIT ASSY,EV-LMP.	80200.1	127	1	ON CREW-LMP(RH STA)	39.3	1043.0	24.5	-10.4

NOTE: Further information relating to this table is given on pages 3.4-19, 3.4-20 and 3.4-21.

Table 3.4-9.2 (Continued)

MISSION H-3 TRANSFERRED CREW AND EQUIPMENT STOWAGE LIST								
ITEMS REARRANGED IN CM POST A/S JETTISON (21)								
APOLLO COORDINATES								
DESCRIPTION	STOW. ITEM	REF	NO.	STOWAGE LOCATION	WEIGHT	X-C.G.	Y-C.G.	Z-C.G.
HELMET ASSY, PRESSURE-LMP.	80200.2	127	1	ON CREW-LMP(RH STA)	2.5	1043.0	24.5	-10.4
GLOVES, IV(PAIR)-LMP.	80200.7	127	1	ON CREW-LMP(RH STA)	1.6	1043.0	24.5	-10.4
COMMUNICATIONS CARRIER-LMP.	80200.4	127	1	ON CREW-LMP(RH STA)	1.6	1043.0	24.5	-10.4
POCKET,CHECKLIST+SCISSORS-LMP.	80200.5	167	1	ON PGA (CREW-RH STA)	.2	1043.0	24.5	-10.4
POCKET,CHECKLIST-LMP.	80200.6	167	1	ON PGA (CREW-RH STA)	.2	1043.0	24.5	-10.4
T-ADAPTER,CWG-LMP.	80135.	111	1	IN ADAPTER BAG (A8)	.4	1012.0	22.0	-23.0
JACKET ASSY, ICG-LMP.	80112.1	111	1	IN CM PGA CONTAINER	1.8	1015.0	.0	-19.9
TROUSER ASSY, ICG-LMP.	80112.2	111	1	IN CM PGA CONTAINER	1.8	1015.0	.0	-19.9
BOOT, RIGHT, ICG-LMP.	80112.3	111	1	IN CM PGA CONTAINER	.4	1015.0	.0	-19.9
BOOT, LEFT, ICG-LMP.	80112.4	111	1	IN CM PGA CONTAINER	.4	1015.0	.0	-19.9
EARTUBE, UNIVERSAL-LMP.	E0105.	111	1	ON ICG (PGA CONTAINER)	NEGL	1015.0	.0	-19.9
HEADSET, LIGHTWEIGHT-LMP.	E0104.	111	1	AREA A8	.4	1012.0	22.0	-23.0
GARMENT, CONSTANT WEAR-LMP.	80208.	111	1	IN CM PGA CONTAINER	.8	1015.0	.0	-19.9
GARMENT, LIQUID COOLING - LMP.	80107.	111	1	ON CREW-LMP(RH STA)	5.0	1043.0	24.5	-10.4
SUBSYSTEM, FECAL CONTAINMNT-CDR	80113.	117	1	UN CREW-CDR(CTR.STA)	.3	1043.0	.0	-10.4
SUBSYSTEM, FECAL CONTAINMNT-LMP	80113.	117	1	ON CREW-LMP(RH STA)	.3	1043.0	24.5	-10.4
BAG, DECON, LUNAR SAMPLE	06425.	111	1	AREA A8	5.0	1012.0	22.0	-23.0
BAG, DECON, LUNAR SAMPLE	06426.	111	1	AREA A8	5.0	1012.0	22.0	-23.0
BAG, DECONTAM., CSC CASSETTE	06328.	111	1	SRC 1 DECON.BAG (A8)	.1	1012.0	22.0	-23.0
BAG, DECONTAM, CONTNR. LUNAR SRC	06329.	111	1	SRC 1 DECON.BAG (A8)	.1	1012.0	22.0	-23.0
BAG, DECONTAM, LS HASSELBLAD MAG	06330.	111	1	SRC 1 DECON.BAG (A8)	.2	1012.0	22.0	-23.0
BAG, DECONTAMINATION, SRC NO.2	06331.	111	1	SRC 1 DECON.BAG (A8)	.9	1012.0	22.0	-23.0
BAG, DECONTAMINATION, SRC NO.1	06331.1	111	1	AREA A8	.9	1012.0	22.0	-23.0
BAG, DECONTAMINATION, ISA	06385.	111	1	AREA A8	4.6	1012.0	22.0	-23.0
BAG, RETURN EQUIPMENT	06394.	111	1	AREA A8	1.0	1012.0	22.0	-23.0
BAG, DECONTAM., 16MM L.S. MAG.	06409.	111	1	AREA A8	.3	1012.0	22.0	-23.0
DECON. BAG, 70MM MAG.	06431.	111	1	AREA A8	.2	1012.0	22.0	-23.0
CM EQUIP.RELOC.3					174.60	1036.95	4.45	-12.70

NOTE: Further information relating to this table is given on pages 3.4-19, 3.4-20 and 3.4-21.

Table 3.4-9.2 (Continued)

MISSION H-3 TRANSFERRED CREW AND EQUIPMENT STORAGE LIST								
ITEMS REARRANGED IN CM POST A/S JETTISON (22)								
APOLLO COORDINATES								
DESCRIPTION	STOW. ITEM	REF	NU.	STORAGE LOCATION	WEIGHT	X-C.G.	Y-C.G.	Z-C.G.
TORSO+LIMB SUIT ASSY, IV-CMP.	80201.1	127	1	SLEEP RESTRAINT-RT.	30.5	1015.0	22.0	-38.0
HELMET ASSY, PRESSURE-CMP.	80201.2	127	1	SLEEP RESTRAINT-RT.	2.5	1015.0	22.0	-38.0
GLOVES, IV (PAIR)-CMP.	80201.3	127	1	SLEEP RESTRAINT-RT.	1.7	1015.0	22.0	-38.0
COMMUNICATIONS CARRIER-CMP.	80201.4	127	1	IN ACCES. BAG (HSB/CMP)	1.6	1043.0	-22.0	-55.5
POCKET, CHECKLIST+SCISSORS-CMP.	80201.5	167	1	ON ICG-CJR./CTR.STA.	.2	1043.0	.0	-10.4
POCKET, CHECKLIST-CMP	80201.6	167	1	ON ICG-CJR./CTR.STA.	.2	1043.0	.0	-10.4
BAG, MOTION SICKNESS-CMP.	A0203.	111	1	ON PGA (PGA CONTAINER)	.1	1015.0	.0	-19.9
UCTA-CMP.	80205.	117	1	ON CREW-CMP (LH STA)	.5	1043.0	-24.5	-10.4
T-ADAPTER, CWG-CMP.	80135.	111	1	ON CREW-CMP (LH STA)	.4	1043.0	-24.5	-10.4
JACKET ASSY, ICG-CMP.	80112.1	111	1	ON CREW-CMP (LH STA)	1.8	1043.0	-24.5	-10.4
TROUSER ASSY, ICG-CMP.	80112.2	111	1	ON CREW-CMP (LH STA)	1.8	1043.0	-24.5	-10.4
BOOT, RIGHT, ICG-CMP.	80112.3	111	1	ON CREW-CMP (LH STA)	.4	1043.0	-24.5	-10.4
BOOT, LEFT, ICG-CMP.	80112.4	111	1	ON CREW-CMP (LH STA)	.4	1043.0	-24.5	-10.4
EARTUBE, UNIVERSAL-CMP.	E0105.1	111	1	ON ICG-CMP./LH STA.	NEGL	1043.0	-24.5	-10.4
HEADSET, LIGHTWEIGHT-CMP.	E0104.	111	1	ON CREW-CMP (LH STA)	.4	1043.0	-24.5	-10.4
SUBSYSTEM, FECAL CONTAINMENT-CMP	80113.	117	1	AREA U1	.3	1033.0	23.0	-50.0
TORSO+LIMB SUIT ASSY, EV-CDR.	80200.1	127	1	IN CM PGA CONTAINER	39.3	1015.0	.0	-19.9
HELMET ASSY, PRESSURE-CDR.	80200.2	127	1	IN CDR HSB-LH LEB	2.5	1048.0	-30.0	34.0
GLOVES, IV (PAIR)-CDR.	80200.3	127	1	IN ACCES. BAG (HSB/CDR)	1.7	1048.0	-30.0	34.0
COMMUNICATION CARRIER-CDR.	80200.4	127	1	IN ACCES. BAG (HSB/CDR)	1.6	1048.0	-30.0	34.0
POCKET, CHECKLIST+SCISSORS-CDR.	80200.5	167	1	ON ICG-CJR./CTR.STA.	.2	1043.0	.0	-10.4
POCKET, CHECKLIST-CDR.	80200.6	167	1	ON ICG-CJR./CTR.STA.	.2	1043.0	.0	-10.4
T-ADAPTER, CWG-CDR.	80135.	111	1	ON CREW-CDR (CTR.STA)	.4	1043.0	.0	-10.4
JACKET ASSY, ICG-CDR.	80112.1	111	1	ON CREW-CDR (CTR.STA)	1.8	1043.0	.0	-10.4
TROUSER ASSY, ICG-CDR.	80112.2	111	1	ON CREW-CDR (CTR.STA)	1.8	1043.0	.0	-10.4
BOOT, RIGHT, ICG-CDR.	80112.3	111	1	ON CREW-CDR (CTR.STA)	.4	1043.0	.0	-10.4
BOOT, LEFT, ICG-CDR.	80112.4	111	1	ON CREW-CDR (CTR.STA)	.4	1043.0	.0	-10.4
EARTUBE, UNIVERSAL-CDR.	E0105.	111	1	ON ICG-CJR./CTR.STA.	NEGL	1043.0	.0	-10.4
HEADSET, LIGHTWEIGHT-CDR.	E0104.	111	1	ON CREW-CDR (CTR.STA)	.4	1043.0	.0	-10.4
GARMENT, CONSTANT WEAR-CDR.	80203.	111	1	ON CREW-CDR (CTR.STA)	.8	1043.0	.0	-10.4
GARMENT, LIQUID COOLING - CDR.	80107.	111	1	AREA U1	5.0	1033.0	23.0	-50.0
TORSO+LIMB SUIT ASSY, EV-LMP.	80200.1	127	1	IN CM PGA CONTAINER	39.3	1015.0	.0	-19.9

NOTE: Further information relating to this table is given on pages 3.4-19, 3.4-20 and 3.4-21.

Table 3.4-9.2 (Continued)

MISSION H-3 TRANSFERRED CREW AND EQUIPMENT STOWAGE LIST								
ITEMS REARRANGED IN CM POST A/S JETTISON (22)							APOLLO COORDINATES	
DESCRIPTION	STOW. ITEM	REF	NO.	STOWAGE LOCATION	WEIGHT	X-C.G.	Y-C.G.	Z-C.G.
HELMET ASSY,PRESSURE-LMP.	80200.2	127	1	IN LMP HSB-RH BHD	2.5	1034.0	22.0	-55.0
GLOVES,IV(PAIR)-LMP.	80200.7	127	1	IN ACCES.BAG(HSB/LMP	1.6	1034.0	22.0	-55.0
COMMUNICATIONS CARRIER-LMP.	80200.4	127	1	IN ACCES.BAG(HSB/LMP	1.6	1034.0	22.0	-55.0
POCKET,CHECKLIST+SCISSORS-LMP.	80200.5	167	1	ON ICG-L4P./RH STA.	.2	1043.0	24.5	-10.4
POCKET,CHECKLIST-LMP.	80200.6	167	1	ON ICG-LMP./RH STA.	.2	1043.0	24.5	-10.4
T-ADAPTER,LWG-LMP.	80135.	111	1	ON CREW-LMP(RH STA)	.4	1043.0	24.5	-10.4
JACKET ASSY,ICG-LMP.	80112.1	111	1	ON CREW-LMP(RH STA)	1.8	1043.0	24.5	-10.4
TROUSER ASSY,ICG-LMP.	80112.2	111	1	UN CREW-LMP(RH STA)	1.8	1043.0	24.5	-10.4
BOOT,RIGHT,ICG-L4P.	80112.3	111	1	ON CREW-LMP(RH STA)	.4	1043.0	24.5	-10.4
BOOT,LEFT,ICG-LMP.	80112.4	111	1	UN CREW-LMP(RH STA)	.4	1043.0	24.5	-10.4
EARTUBE,UNIVERSAL-LMP.	E0105.	111	1	ON ICG-L4P./RH STA.	NEGL	1043.0	24.5	-10.4
HEADSET,LIGHTWEIGHT-LMP.	E0104.	111	1	ON CREW-LMP(RH STA)	.4	1043.0	24.5	-10.4
GARMENT,CONSTANT WEAR-LMP.	30208.	111	1	ON CREW-LMP(RH STA)	.8	1043.0	24.5	-10.4
GARMENT,LIQUID COOLING - LMP.	80107.	111	1	AREA U1	5.0	1033.0	23.0	-50.0
SUBSYSTEM,FECAL CONTAINMNT-CDR	80113.	117	1	AREA U1	.3	1033.0	23.0	-50.0
SUBSYSTEM,FECAL CONTAINMNT-LMP	80113.	117	1	AREA U1	.3	1033.0	23.0	-50.0
BAG,DECON,LUNAR SAMPLE	06425.	111	1	AREA A13	5.0	1010.0	-22.0	-2.0
BAG,DECON,LUNAR SAMPLE	06426.	111	1	ON CONTAINER A10	5.0	1011.0	23.0	6.0
BAG,DECONTAM.,CSC CASSETTE	06328.	111	1	BAG,RETURN EQUIP(B1)	.1	1050.0	-27.0	39.0
BAG,DECONTAM,CCNTNR,LUNAR SRC	06329.	111	1	BAG,RETURN EQUIP(B1)	.1	1050.0	-27.0	39.0
BAG,DECONTAM,LS HASSELBLAD MAG	06330.	111	1	AREA R13	.2	1024.0	45.0	-26.0
BAG,DECONTAMINATION,SRC NO.2	06331.	111	1	AREA B6	.9	1031.0	13.0	39.0
BAG,DECONTAMINATION,SRC NO.1	06331.1	111	1	AREA B5	.9	1031.0	-8.0	39.0
BAG,DECONTAMINATION,ISA	06395.	111	1	AREA A1	4.6	1012.0	-22.0	-26.0
BAG,RETURN EQUIPMENT	06394.	111	1	AREA B1	1.0	1050.0	-27.0	39.0
BAG,DECONTAM.,16MM L.S. MAG.	06409.	111	1	AREA R13	.3	1024.0	45.0	-26.0
DECON. BAG, 70MM MAG.	06431.	111	1	AREA R13	.2	1024.0	45.0	-26.0
CM EQUIP.RELOC.3					174.60	1021.23	4.90	-21.95

NOTE: Further information relating to this table is given on pages 3.4-19, 3.4-20 and 3.4-21.

Table 3.4-9.2 (Continued)

MISSION H-3 TRANSFERRED CREW AND EQUIPMENT STORAGE LIST								
ITEMS REARRANGED IN CM PRIOR TO ENTRY (23)								
DESCRIPTION	STOW. ITEM	REF	NO.	STOWAGE LOCATION	WEIGHT	APOLLO COORDINATES		
						X-C.G.	Y-C.G.	Z-C.G.
COMMUNICATIONS CARRIER-CMP.	30201.4	127	1	IN ACCES. BAG (HSB/CMP	1.6	1043.0	-22.0	-55.5
HEADSET, LIGHTWEIGHT-CMP.	E0104.	111	1	UN CREW-CMP (LH STA)	.4	1043.0	-24.5	-10.4
GLOVES, IV (PAIR)-CDR.	80200.3	127	1	IN ACCES. BAG (HSB/CDR	1.7	1048.0	-30.0	34.0
COMMUNICATION CARRIER-CDR.	80200.4	127	1	IN ACCES. BAG (HSB/CDR	1.6	1048.0	-30.0	34.0
HEADSET, LIGHTWEIGHT-CDR.	E0104.	111	1	ON CREW-CDR (CTR. STA)	.4	1043.0	.0	-10.4
GLOVES, IV (PAIR)-LMP.	80200.7	127	1	IN ACCES. BAG (HSB/LMP	1.6	1034.0	22.0	-55.0
COMMUNICATIONS CARRIER-LMP.	80200.4	127	1	IN ACCES. BAG (HSB/LMP	1.6	1034.0	22.0	-55.0
HEADSET, LIGHTWEIGHT-LMP.	E0104.	111	1	ON CREW-LMP (RH STA)	.4	1043.0	24.5	-10.4
BAG, HELMET STOW, INFLIGHT-CMP.	80105.	115	1	LH BMD-HSB/CMP	.6	1043.0	-22.0	-55.0
BAG, HELMET STOW, INFLIGHT-CDR.	80105.	115	1	LH LEB-HSB/CDR	.6	1048.0	-30.0	34.0
BAG, HELMET STOW, INFLIGHT-LMP.	80105.	115	1	RH BMD-HSB/LMP	.6	1034.0	22.0	-55.0
BAG, ACCESSORY-CMP.	80105.1	115	1	IN CMP HSB-LH BMD	.3	1043.0	-22.0	-55.0
BAG, ACCESSORY-CDR.	80105.1	115	1	IN CDR HSB-LH LEB	.3	1048.0	-30.0	34.0
BAG, ACCESSORY-LMP.	80105.1	115	1	IN LMP HSB-RH BMD	.3	1034.0	22.0	-55.0
CONTAINER, TEMP. STOW-CMP.	00301.	115	1	RH LEB-TSB	1.7	1039.5	33.5	34.0
CONTAINER, TEMP. STOW-CDR.	00301.	115	1	LH GIRTH RING/TSB	1.7	1028.0	-45.0	-28.0
CONTAINER, TEMP. STOW-LMP.	00301.	115	1	RH GIRTH RING-TSB	1.7	1030.0	36.0	-43.0
CONTAINER, R12	00344	115	1	CONT. R12 (RH GRTH RG)	2.7	1034.0	41.0	-21.0
CSM LAUNCH CHECKLIST	A0114.1	164	2	DFD (R12/RH GRTH.RNG)	1.0	1034.0	41.0	-21.0
CSM G/C CHECKLIST	A0114.2	164	1	DFD (R12/RH GRTH.RNG)	1.0	1034.0	41.0	-21.0
CSM SYSTEM CHECKLIST	A0114.3	164	1	DFD (R12/RH GRTH.RNG)	1.0	1034.0	41.0	-21.0
CSM LUNAR LANDMARK MAP	A0114.5	164	1	DFD (R12/RH GRTH.RNG)	.6	1034.0	41.0	-21.0
CSM DATA SYSTEMS	A0114.7	164	1	DFD (R12/RH GRTH.RNG)	.9	1034.0	41.0	-21.0
CSM MALFUNCTIONS PROCEEDURES	A0114.8	164	1	DFD (R12/RH GRTH.RNG)	.6	1034.0	41.0	-21.0
FLIGHT PLAN	A0114.9	164	1	DFD (R12/RH GRTH.RNG)	3.0	1034.0	41.0	-21.0
CMP SOLO BOOK	A0114.11	164	1	DFD (R12/RH GRTH.RNG)	.9	1034.0	41.0	-21.0
RESCUE BOOK	A0114.15	164	1	DFD (R12/RH GRTH.RNG)	.9	1034.0	41.0	-21.0
SLEEP RESTRAINT ASSY-LH	03022.	117	1	UNDER LH COUCH	3.7	1018.0	-24.5	-15.0
PAD, HEADREST-CDR.	R0130.	117	1	AREA A5	1.1	1015.0	9.0	28.0
HEEL RESTRAINT (PR)-CDR.	H0132.	117	1	AREA A5	1.2	1015.0	9.0	28.0

NOTE: Further information relating to this table is given on pages 3.4-19, 3.4-20 and 3.4-21.

Table 3.4-9.2 (Continued)

MISSION H-3 TRANSFERRED CREW AND EQUIPMENT STOWAGE LIST								
ITEMS REARRANGED IN CM PRIOR TO ENTRY (23)								
APOLLO COORDINATES								
DESCRIPTION	STOW. ITEM	REF	NO.	STOWAGE LOCATION	WEIGHT	X-C.G.	Y-C.G.	Z-C.G.
PAD, HEADREST-LMP.	80130.	117	1	AREA A5	1.1	1015.0	9.0	28.0
HEEL RESTRAINT(PRI)-L4P	80132.	117	1	AREA A5	1.2	1015.0	9.0	28.0
PAD, HEADREST-CMP.	80130.	117	1	AREA A5	1.1	1015.0	9.0	28.0
HEEL RESTRAINT(PRI)-CMP.	80132.	117	1	AREA A5	1.2	1015.0	9.0	28.0
FILTER, CABIN FAN	06395.	111	1	FILTER BAG(PGA CONT)	2.4	1015.0	.0	-19.9
STOW.BAG, CABIN FAN FILTER	06410.	111	1	IN CM PGA CONTAINER	1.6	1015.0	.0	-19.9
CM EQUIP.RELOC.4					44.30	1029.90	9.91	-11.35

NOTE: Further information relating to this table is given on pages 3.4-19, 3.4-20 and 3.4-21.

Table 3.4-9.2 (Continued)

MISSION H-3 TRANSFERRED CREW AND EQUIPMENT STOWAGE LIST								
ITEMS REARRANGED IN CM PRIOR TO ENTRY (24)								
DESCRIPTION	STOW. ITEM	REF	NO.	STOWAGE LOCATION	WEIGHT	APOLLO COORDINATES		
						X-C.G.	Y-C.G.	Z-C.G.
COMMUNICATIONS CARRIER-CMP.	B0201.4	127	1	ON CREW-CMP(LH STA)	1.6	1043.0	-24.5	-10.4
HEADSET, LIGHTWEIGHT-CMP.	E0104.	111	1	AREA A8	.4	1012.0	22.0	-23.0
GLOVES, IV(PAIR)-CDR.	B0200.3	127	1	ACCES. BAG (HSB/R6)	1.7	1048.0	46.0	29.0
COMMUNICATION CARRIER-CDR.	B0200.4	127	1	ON CREW-CUR(CTR. STA)	1.6	1043.0	.0	-10.4
HEADSET, LIGHTWEIGHT-CDR.	E0104.	111	1	AREA A8	.4	1012.0	22.0	-23.0
GLOVES, IV(PAIR)-LMP.	B0200.7	127	1	ACCES. BAG (HSB/L3)	1.6	1048.0	-47.0	12.0
COMMUNICATIONS CARRIER-LMP.	B0200.4	127	1	ON CREW-LMP(RH STA)	1.6	1043.0	24.5	-10.4
HEADSET, LIGHTWEIGHT-LMP.	E0104.	111	1	AREA A8	.4	1012.0	22.0	-23.0
BAG, HELMET STOW, INFLIGHT-CMP.	B0105.	115	1	AREA B1	.6	1050.0	-27.0	39.0
BAG, HELMET STOW, INFLIGHT-CDR.	B0105.	115	1	AREA R6	.6	1048.0	46.0	29.0
BAG, HELMET STOW, INFLIGHT-LMP.	B0105.	115	1	AREA L3	.6	1048.0	-47.0	12.0
BAG, ACCESSORY-CMP.	B0105.1	115	1	HELMET STOW BAG (B1)	.3	1050.0	-27.0	39.0
BAG, ACCESSORY-CDR.	B0105.1	115	1	HELMET STOW BAG (R6)	.3	1048.0	46.0	29.0
BAG, ACCESSORY-LMP.	B0105.1	115	1	HELMET STOW BAG (L3)	.3	1048.0	-47.0	12.0
CONTAINER, TEMP. STOW-CMP.	00301.	115	1	AREA A1	1.7	1012.0	-22.0	-26.0
CONTAINER, TEMP. STOW-CDR.	00301.	115	1	AREA A1	1.7	1012.0	-22.0	-26.0
CONTAINER, TEMP. STOW-LMP.	00301.	115	1	AREA A1	1.7	1012.0	-22.0	-26.0
CONTAINER, R12	00344	115	1	AREA R3	2.7	1072.0	26.0	9.0
CSM LAUNCH CHECKLIST	A0114.1	164	2	IN FDF (R12/IN R3)	1.0	1072.0	26.0	9.0
CSM G/C CHECKLIST	A0114.2	164	1	IN FDF (R12/IN R3)	1.0	1072.0	26.0	9.0
CSM SYSTEM CHECKLIST	A0114.3	164	1	IN FDF (R12/IN R3)	1.0	1072.0	26.0	9.0
CSM LUNAR LANDMARK MAP	A0114.5	164	1	IN FDF (R12/IN R3)	.6	1072.0	26.0	9.0
CSM DATA SYSTEMS	A0114.7	164	1	IN FDF (R12/IN R3)	.9	1072.0	26.0	9.0
CSM MALFUNCTIONS PROCEDURES	A0114.8	164	1	IN FDF (R12/IN R3)	.6	1072.0	26.0	9.0
FLIGHT PLAN	A0114.9	164	1	IN FDF (R12/IN R3)	3.0	1072.0	26.0	9.0
CMP SOLU BOOK	A0114.11	164	1	IN FDF (R12/IN R3)	.9	1072.0	26.0	9.0
RESCUE BOOK	A0114.15	164	1	IN FDF (R12/IN R3)	.9	1072.0	26.0	9.0
SLEEP RESTRAINT ASSY-LH	U3022.	117	1	AFT UPR EQUIP. BAY-LH	3.7	1018.0	-21.9	-49.9
PAO, HEADSET-CDR.	B0130.	117	1	ON COUCH(CTR. CRW. STA)	1.1	1043.0	.0	-10.4
HEEL RESTRAINT(PR)-LMP.	B0132.	117	1	ON CREW-CUR(CTR. STA)	1.2	1043.0	.0	-10.4

NOTE: Further information relating to this table is given on pages 3.4-19, 3.4-20 and 3.4-21.

Table 3.4-9.2 (Continued)

MISSION H-3 TRANSFERRED CREW AND EQUIPMENT STORAGE LIST								
ITEMS REARRANGED IN CM PRIOR TO ENTRY (24)								
DESCRIPTION	STOW. ITEM	REF	NO.	STOWAGE LOCATION	WEIGHT	APOLLO COORDINATES		
						X-C.G.	Y-C.G.	Z-C.G.
PAD, HEADREST-LMP.	80130.	117	1	ON COUCH(RH CREW STA	1.1	1043.0	24.5	-10.4
HEEL RESTRAINT(PR)-LIP	80132.	117	1	ON CREW-LMP(RH STA)	1.2	1043.0	24.5	-10.4
PAD, HEADREST-CMP.	80130.	117	1	ON COUCH(LH CREW STA	1.1	1043.0	-24.5	-10.4
HEEL RESTRAINT(PR)-CMP.	80132.	117	1	ON CREW-CMP(LH STA)	1.2	1043.0	-24.5	-10.4
FILTER, CABIN FAN	06395.	111	1	AREA A8	2.4	1012.0	22.0	-23.0
STOW.BAG, CABIN FAN FILTER	06410.	111	1	AREA A8	1.6	1012.0	22.0	-23.0
CM EQUIP.RELOC.4					44.30	1042.67	5.11	-6.88

NOTE: Further information relating to this table is given on pages 3.4-19, 3.4-20 and 3.4-21.

Table 3.4-9.2 (Continued)

LM-9 EMERGENCY LIFTOFF TRANSFERABLE EQUIPMENT LIST								
ITEMS REARRANGED IN ASCENT STAGE PRE EVA 1 FOR EMERGENCY LIFTOFF								
DESCRIPTION	STOW. ITEM	REF	NO.	STOWAGE LOCATION	WEIGHT	X-C.G.	Y-C.G.	Z-C.G.
REMOTE CONTROL UNIT- PLSS	81001.		1	ON MINUS Z27 BHD-RCU	5.1	280.0	.0	-21.5
REMOTE CONTROL UNIT- PLSS	81001.		1	ON MINUS Z27 BHD-RCU	5.1	280.0	.0	-21.5
BAG, JETTISON STOWAGE	81027		1	LH SIDE STOW.COMPT.	.9	235.0	-34.0	45.0
O2 PURGE SYS STOWAGE BRACKETS	03004.		1	ON OPS(SRC RACK NO.1	2.4	257.4	-20.7	-6.0
O2 PURGE SYS STOWAGE BRACKETS	03004.		1	ON OPS(SRC RACK NO.2	2.4	265.9	-20.7	-6.0
ARM RESTS - CDR	TBD		1	LH CREW STA-INSTAL.	1.1	282.5	-6.5	51.0
ARM RESTS - LMP	TBD		1	RH CREW STA-INSTAL.	1.1	284.5	6.5	52.0
ARM RESTS - LMP	TBD		1	RH CREW STA-INSTAL.	1.1	284.5	6.5	52.0
BAG, 16MM CAMERA- STOWAGE	03062.		1	LH SIDE STOW.COMPT.	1.0	235.0	-34.0	45.0
BUDDY SLSS ASSY	81052.		1	ON PLUS Z27 BHD	10.9	260.0	-37.0	28.0
PLSS/EVC ASSY- LMP	81025.		1	ON CABIN FLOOR-PLSS	83.0	219.7	.0	44.7
CAMERA L.S. ELECT. HASSELGLAD	A1015.		1	RH SIDE STOW.COMPT.	3.1	238.4	38.6	46.0
MAG, 70MM L.S. HASSELGLAD	A0108. 1		1	RH SIDE STOW.COMPT.	1.4	238.4	38.6	46.0
OXYGEN PURGE SYSTEM	81012. 2		1	SRC RACK NO.1-LWR.	35.0	257.4	-20.7	-6.0
OXYGEN PURGE SYSTEM	81012. 2		1	SRC RACK NO.2-UPR.	35.0	265.9	-20.7	-6.0
LENS,60 MM L.S.E.H.	A1016.		1	RH SIDE STOW.COMPT.	1.8	238.4	38.6	46.0
TRIGGER, L.S.E.H.	A1027.		1	RH SIDE STOW.COMPT.	.2	238.4	38.6	46.0
HANDLE, L.S.E.H.	A1028.		1	RH SIDE STOW.COMPT.	.5	238.4	38.6	46.0
CONTAINER, BUDY SLSS	03059.		1	ON PLUS Z27 BHD	3.1	260.0	-37.0	28.0
KIT,EMU MAINTENANCE	81016.		1	HSB/LH(ON CABIN FLRI	.5	221.0	-18.3	53.0
PURGE VALVE ASSY	81017.		1	UPR.BOOT BOX	.5	280.8	-20.0	-9.5
PURGE VALVE ASSY	81017.		1	LWR.BOOT BOX	.5	273.8	-20.0	-9.5
B+W TV SYSTEM	E1000.		1	ON MINUS Z27 BHD- TV	7.6	285.0	.0	-21.5
PRE EVA 1 REANG.					203.30	245.49	-9.26	19.01

NOTE: Further information relating to this table is given on pages 3.4-19, 3.4-20 and 3.4-21.

Table 3.4-9.2 (Continued)

LN-8 EMERGENCY LIFTOFF TRANSFERABLE EQUIPMENT LIST								
ITEMS REARRANGED IN ASCENT STAGE PRE EVA 1 FOR EMERGENCY LIFTOFF								
DESCRIPTION	STOW. ITEM	REF	NO.	STOWAGE LOCATION	WEIGHT	X-C.G.	V-C.G.	Z-C.G.
REMOTE CONTROL UNIT- PLSS	B1001.		1	ISA(OVER AS ENG CVR)	5.1	280.0	.0	-10.0
REMOTE CONTROL UNIT- PLSS	B1001.		1	ISA(OVER AS ENG CVR)	5.1	280.0	.0	-10.0
BAG, JETTISON STOWAGE	B1027		1	ISA(OVER AS ENG CVR)	.9	280.0	.0	-10.0
O2 PURGE SYS STOWAGE BRACKETS	O3004.		1	ISA(OVER AS ENG CVR)	2.4	280.0	.0	-10.0
O2 PURGE SYS STOWAGE BRACKETS	O3004.		1	ISA(OVER AS ENG CVR)	2.4	280.0	.0	-10.0
ARM RESTS - CDR	TBD		1	ISA(OVER AS ENG CVR)	1.1	280.0	.0	-10.0
ARM RESTS - LMP	TBD		1	ISA(OVER AS ENG CVR)	1.1	280.0	.0	-10.0
ARM RESTS - LMP	TBD		1	ISA(OVER AS ENG CVR)	1.1	280.0	.0	-10.0
BAG, 16MM CAMERA- STOWAGE	O3062.		1	ISA(OVER AS ENG CVR)	1.0	280.0	.0	-10.0
BUDDY SLSS ASSY	B1052.		1	ISA(OVER AS ENG CVR)	10.9	280.0	.0	-10.0
PLSS/EVC ASSY- LMP	B1025.		1	PLSS DONNING STA.	83.0	275.0	-5.0	19.2
CAMERA L.S. ELECT. HASSELBLAD	A1015.		1	ISA(OVER AS ENG CVR)	3.1	280.0	.0	-10.0
MAG, 70MM L.S. HASSELBLAD	A0108. 1		1	ISA(OVER AS ENG CVR)	1.4	280.0	.0	-10.0
OXYGEN PURGE SYSTEM	B1012. 2		1	ON CABIN FLOOR-OPS	35.0	219.7	.0	44.7
OXYGEN PURGE SYSTEM	B1012. 2		1	ON CABIN FLOOR-OPS	35.0	219.7	.0	44.7
LENS, 60 MM L.S.E.H.	A1016.		1	ISA(OVER AS ENG CVR)	1.8	280.0	.0	-10.0
TRIGGER, L.S.E.H	A1027.		1	ISA(OVER AS ENG CVR)	.2	280.0	.0	-10.0
HANDLE, L.S.F.H.	A1028.		1	ISA(OVER AS ENG CVR)	.5	280.0	.0	-10.0
CONTAINER, BUDY SLSS	O3059.		1	ISA(OVER AS ENG CVR)	3.1	280.0	.0	-10.0
KIT, EMU MAINTENANCE	B1016.		1	ISA(OVER AS ENG CVR)	.5	280.0	.0	-10.0
PURGE VALVE ASSY	B1017.		1	ISA(OVER AS ENG CVR)	.5	280.0	.0	-10.0
PURGE VALVE ASSY	B1017.		1	ISA(OVER AS ENG CVR)	.5	280.0	.0	-10.0
B+W TV SYSTEM	E1000.		1	ISA(OVER AS ENG CVR)	7.6	280.0	.0	-10.0
PRE EVA 1 REANG.					203.30	257.20	-2.04	20.76

NOTE: Further information relating to this table is given on pages 3.4-19, 3.4-20 and 3.4-21.

Table 3.4-9.2 (Continued)

L4-8 EMERGENCY LIFTOFF TRANSFERABLE EQUIPMENT LIST								
ITEMS OFFLOADED AT LUNAR SITE DURING EVA 1								
						LM COORDINATES		
DESCRIPTION	STOW. ITEM	REF	NO.	STOWAGE LOCATION	WEIGHT	X-C.G.	Y-C.G.	Z-C.G.
CONVEYOR ASSY, LUNAR ED. (LEC)	B1020. 2		1	LH SIDE STOW.COMPT.	1.2	235.0	-34.0	45.0
BAG, JETTISON STOWAGE	B1027		1	LH SIDE STOW.COMPT.	.9	235.0	-34.0	45.0
O2 PURGE SYS STOWAGE BRACKETS	03004.		1	ON OPSISRC RACK NO.1	2.4	257.4	-20.7	-6.0
O2 PURGE SYS STOWAGE BRACKETS	03004.		1	ON OPSISRC RACK NO.2	2.4	265.9	-20.7	-6.0
ARM RESTS - CDR	TBD		1	LH CREW STA-INSTAL.	1.1	282.5	-6.5	51.0
ARM RESTS - LMP	TBD		1	RH CREW STA-INSTAL.	1.1	284.5	6.5	52.0
ARM RESTS - LMP	TBD		1	RH CREW STA-INSTAL.	1.1	284.5	6.5	52.0
BAG, 16MM CAMERA- STOWAGE	03052.		1	LH SIDE STOW.COMPT.	1.0	235.0	-34.0	45.0
LM LUNAR SURFACE MAPS	A1009. 5		1	FLIGHT DATA FILE CTR	1.7	280.8	-20.0	14.0
CAMERA L.S. ELECT. HASSELBLAD	A1015.		1	RH SIDE STOW.COMPT.	3.1	238.4	38.6	46.0
CAMERA L.S. ELECT. HASSELBLAD	A1015.		1	RH SIDE STOW.COMPT.	3.1	238.4	38.6	46.0
MAG, 70MM L.S. HASSELBLAD	A0109. 1		2	RH SIDE STOW.COMPT.	2.8	238.4	38.6	46.0
MAGAZINE, 16MM DATA ACQUISITION	A0101. 1		1	ISA(OVER AS ENG CVR)	1.0	280.0	.0	-10.0
CAMERA, 16MM DATA ACQUISITION	A1043.		1	LH SIDE STOW.COMPT.	8.9	235.0	-34.0	45.0
MAGAZINE, 16MM DATA ACQUISITION	A0101. 1		2	RH SIDE STOW.COMPT.	2.0	238.4	38.6	46.0
SAMPLES, THERMO CUAT. DEGRAD.	F1002.		2	ISA(OVER AS ENG CVR)	.8	280.0	.0	-10.0
CLSRC (WITHOUT SAMPLE)	G4016.		1	LH SIDE STOW.COMPT.	.6	235.0	-34.0	45.0
LENS,60 MM L.S.E.H.	A1016.		1	RH SIDE STOW.COMPT.	1.8	238.4	38.6	46.0
LENS,60 MM L.S.E.H.	A1016.		1	RH SIDE STOW.COMPT.	1.8	238.4	38.6	46.0
TRIGGER, L.S.E.H.	A1027.		1	RH SIDE STOW.COMPT.	.2	238.4	38.6	46.0
TRIGGER, L.S.E.H.	A1027.		1	RH SIDE STOW.COMPT.	.2	238.4	38.6	46.0
HANDLE, L.S.E.H.	A1028.		1	RH SIDE STOW.COMPT.	.5	238.4	38.6	46.0
HANDLE, L.S.E.H.	A1028.		1	RH SIDE STOW.COMPT.	.5	238.4	38.6	46.0
BRACKET, CAMERA MOUNT	B1001. 1		1	ISA(OVER AS ENG CVR)	.6	280.0	.0	-10.0
BRACKET, CAMERA MOUNT	B1001. 1		1	ISA(OVER AS ENG CVR)	.6	280.0	.0	-10.0
BAG,LFC	B1020. 1		1	LH SIDE STOW.COMPT.	.2	235.0	-34.0	45.0
CONTAINER, RUDY SLESS	03059.		1	ON PLUS 227 BHD	3.1	260.0	-37.0	28.0
ADAPTER, BRACKET, XT. ANGLE	A1021.		1	LH SIDE STOW.COMPT.	.2	235.0	-34.0	45.0
CABLE, REMOTE CONTROL	A1022.		1	LH SIDE STOW.COMPT.	.7	235.0	-34.0	45.0
B+W TV SYSTEM	E1000.		1	ON MINUS 227 BHD- TV	7.6	285.0	.0	-21.5
BAG,CAMERA MOUNT BRKT	03034.		1	ISA(OVER AS ENG CVR)	.3	280.0	.0	-10.0
EVA 1 OFFLOAD					53.50	254.20	-1.67	26.33

NOTE: Further information relating to this table is given on pages 3.4-19, 3.4-20 and 3.4-21.

Table 3.4-9.2 (Continued)

LM-8 EMERGENCY LIFTOFF TRANSFERABLE EQUIPMENT LIST								
ITEMS UNLOADED INTO ASC. STAGE DURING EVA 1								
DESCRIPTION	STOW. ITEM	REF	NO.	STORAGE LOCATION	WEIGHT	LM COORDINATES		
						X-C.G.	Y-C.G.	Z-C.G.
CRT./CAN, PLSS LIGHT REPLACEMENT	B1003.		2	FLIGHT DATA FILE CTR	13.4	280.8	-20.0	14.0
BAG, LUNAR EQUIPMENT TRANSFER	O3018.		1	R.H. CAB. FLOOR, FORWARD	.9	221.7	24.0	60.5
LM LUNAR SURFACE MAPS	A1039. 5		1	ETB (RH FLOOR, FWD)	1.7	221.7	24.0	60.5
CAMERA L.S. ELECT. HASSELBLAD	A1015.		1	ETB (RH FLOOR, FWD)	3.1	221.7	24.0	60.5
CAMERA L.S. ELECT. HASSELBLAD	A1015.		1	ETB (RH FLOOR, FWD)	3.1	221.7	24.0	60.5
MAG, 70MM L.S. HASSELBLAD	A0108. 1		2	ETB (RH FLOOR, FWD)	2.8	221.7	24.0	60.5
MAGAZINE, 16MM DATA ACQUISITION	A0101. 1		1	ETB (RH FLOOR, FWD)	1.0	221.7	24.0	60.5
MAGAZINE, 16MM DATA ACQUISITION	A0101. 1		2	ETB (RH FLOOR, FWD)	2.0	221.7	24.0	60.5
CONTNR. SAMPL. RET. NO. 1 (100)	O4003.		1	SRC RACK NO. 1-LWR.	65.0	257.4	-20.7	-6.0
WEIGH BAG WITH SMALL ROCKS	G4018.		1	ISA (OVER AS ENG CVR)	15.0	280.0	.0	-10.0
WEIGH BAG WITH FOOTBALL S17-RK	G4018.		1	LM SIDE STOW. COMPT.	30.0	235.0	-34.0	45.0
CLSRC (WITH SAMPLE)	G4016.		1	ISA (OVER AS ENG CVR)	2.6	280.0	.0	-10.0
LENS/SCRIBE/BRUSH	T80		1	ETB (RH FLOOR, FWD)	.3	221.7	24.0	60.5
LENS, 60 MM L.S.E.H.	A1016.		1	ETB (RH FLOOR, FWD)	1.8	221.7	24.0	60.5
LENS, 60 MM L.S.E.H.	A1016.		1	ETB (RH FLOOR, FWD)	1.8	221.7	24.0	60.5
TRIGGER, L.S.E.H.	A1027.		1	ETB (RH FLOOR, FWD)	.2	221.7	24.0	60.5
TRIGGER, L.S.E.H.	A1027.		1	ETB (RH FLOOR, FWD)	.2	221.7	24.0	60.5
HANDLE, L.S.E.H.	A1028.		1	ETB (RH FLOOR, FWD)	.5	221.7	24.0	60.5
HANDLE, L.S.E.H.	A1028.		1	ETB (RH FLOOR, FWD)	.5	221.7	24.0	60.5
BRACKET, CAMERA MOUNT	B1001. 1		1	ETB (RH FLOOR, FWD)	.6	221.7	24.0	60.5
BRACKET, CAMERA MOUNT	B1001. 1		1	ETB (RH FLOOR, FWD)	.6	221.7	24.0	60.5
EVA 1 UNLOAD					147.10	252.55	-14.46	15.28

NOTE: Further information relating to this table is given on pages 3.4-19, 3.4-20 and 3.4-21.

Table 3.4-9.2 (Continued)

LM-8 EMERGENCY LIFTOFF TRANSFERABLE EQUIPMENT LIST								
ITEMS REARRANGED IN ASCENT STAGE PRE EVA 2 FOR EMERGENCY LIFTOFF								
DESCRIPTION	STOW. ITEM	REF	NO.	STOWAGE LOCATION	WEIGHT	X-C.G.	Y-C.G.	Z-C.G.
REMOTE CONTROL UNIT- PLSS	B1001.		1	ON MINUS Z27 BHD-RCU	5.1	280.0	.0	-21.5
REMOTE CONTROL UNIT- PLSS	B1001.		1	ON MINUS Z27 BHD-RCU	5.1	280.0	.0	-21.5
CRT./CAN, PLSS LITHIUM REPLACEMENT	B1003.		2	FLIGHT DATA FILE CTR	13.4	280.8	-20.0	14.0
BAG, PLSS FEEDWATER COLLECTION	B1026.		2	LH SIDE STOW.COMPT.	.8	235.0	-34.0	45.0
BAG, PLSS FEEDWTR. COL. W/O SCALE	B1026.		1	LH SIDE STOW.COMPT.	.5	235.0	-34.0	45.0
URINE BAGS	U3009.		2	RH SIDE STOW.COMPT.	.6	238.4	38.6	46.0
BAG, LUNAR EQUIPMENT TRANSFER	U3019.		1	R.H. CAB. FLOOR, FORWARD	.9	221.7	24.0	60.5
HAMMOCK-CDR	O3048.		1	LH SIDE STOW.COMPT.	4.1	235.0	-34.0	45.0
HAMMOCK-LMP	O3050.		1	LH SIDE STOW.COMPT.	3.9	235.0	-34.0	45.0
BATTERY, PLSS	B1004.		1	LH SIDE STOW.COMPT.	5.5	235.0	-34.0	45.0
BATTERY, PLSS	B1004.		1	LH SIDE STOW.COMPT.	5.5	235.0	-34.0	45.0
BUDDY SLSS ASSY	B1052.		1	UN PLUS Z27 BHD	10.9	260.0	-37.0	28.0
PLSS/EVC ASSY- L4P	B1025.		1	ON CABIN FLOOR-PLSS	83.0	219.7	.0	44.7
CAMERA L.S. ELECT. HASSELRLAD	A1015.		1	ETB (RH FLOOR, FWD)	3.1	221.7	24.0	60.5
CAMERA L.S. ELECT. HASSELRLAD	A1015.		1	ETB (RH FLOOR, FWD)	3.1	221.7	24.0	60.5
MAG, 70MM L.S. HASSELRLAD	A0108. 1		2	ETB (RH FLOOR, FWD)	2.8	221.7	24.0	60.5
MAG, 70MM L.S. HASSELRLAD	A0108. 1		1	RH SIDE STOW.COMPT.	1.4	238.4	38.6	46.0
MAGAZINE, 16MM DATA ACQUISITION	A0101. 1		1	ETB (RH FLOOR, FWD)	1.0	221.7	24.0	60.5
MAGAZINE, 16MM DATA ACQUISITION	A0101. 1		2	ETB (RH FLOOR, FWD)	2.0	221.7	24.0	60.5
DISPOSAL CONTAINER*	O3012.		1	LH SIDE STOW.COMPT.	1.8	235.0	-34.0	45.0
LENS/SCRIBE/BRUSH	T80		1	ETB (RH FLOOR, FWD)	.3	221.7	24.0	60.5
POLARIZING FILTER	A1005.		1	RH SIDE STOW.COMPT.	.2	238.4	38.6	46.0
LM ECS CARTRIDGE +BRACKET	O3008.		1	AFT OF ASC. ENG. COVER	9.2	245.8	8.8	-15.0
OXYGEN PURGE SYSTEM	B1012. 2		1	SRC RACK NO.1-LWR.	35.0	257.4	-20.7	-6.0
OXYGEN PURGE SYSTEM	R1012. 2		1	SRC RACK NO.2-UPR.	35.0	265.9	-20.7	-6.0
LENS, 60 MM L.S.E.H.	A1016.		1	ETB (RH FLOOR, FWD)	1.8	221.7	24.0	60.5
LENS, 60 MM L.S.E.H.	A1016.		1	ETB (RH FLOOR, FWD)	1.8	221.7	24.0	60.5
TRIGGER, L.S.E.H.	A1027.		1	ETB (RH FLOOR, FWD)	.2	221.7	24.0	60.5
TRIGGER, L.S.E.H.	A1027.		1	ETB (RH FLOOR, FWD)	.2	221.7	24.0	60.5
HANDLE, L.S.E.H.	A1028.		1	ETB (RH FLOOR, FWD)	.5	221.7	24.0	60.5
HANDLE, L.S.E.H.	A1028.		1	ETB (RH FLOOR, FWD)	.5	221.7	24.0	60.5

NOTE: Further information relating to this table is given on pages 3.4-19, 3.4-20 and 3.4-21.

Table 3.4-9.2 (Continued)

LM-8 EMERGENCY LIFTOFF TRANSFERABLE EQUIPMENT LIST								
ITEMS REARRANGED IN ASCENT STAGE PRE EVA 2 FOR EMERGENCY LIFTOFF								
DESCRIPTION	STOW. ITEM	REF	NO.	STOWAGE LOCATION	WEIGHT	X-C.G.	Y-C.G.	Z-C.G.
BRACKET, CAMERA MOUNT	B1001. 1		1	ETR (RH FLOOR, FWD)	.6	221.7	24.0	60.5
BRACKET, CAMERA MOUNT	B1001. 1		1	ETR (RH FLOOR, FWD)	.6	221.7	24.0	60.5
KIT, EMU MAINTENANCE	B1016.		1	MSB/LH(ON CABIN FLR)	.5	221.0	-18.3	53.0
PURGE VALVE ASSY	B1017.		1	UPR. BOOT BOX	.5	280.8	-20.0	-9.5
PURGE VALVE ASSY	B1017.		1	LWR. BOOT BOX	.5	273.8	-20.0	-9.5
SAMPLE SCALE	G4031.			LH SIDE STOW.COMPT.	1.5	235.0	-34.0	45.0
PRE EVA 2 REANG.					243.40	242.50	-9.53	23.74

NOTE: Further information relating to this table is given on pages 3.4-19, 3.4-20 and 3.4-21.

Table 3.4-9.2 (Continued)

LM-B EMERGENCY LIFTOFF TRANSFERABLE EQUIPMENT LIST								
ITEMS REARRANGED IN ASCENT STAGE PRE EVA 2 FOR EMERGENCY LIFTOFF								
DESCRIPTION	STOW. ITEM	REF	NO.	STOWAGE LOCATION	WEIGHT	X-C.G.	Y-C.G.	Z-C.G.
REMOTE CONTROL UNIT- PLSS	31001.		1	UPR. BOOT BOX	5.1	280.8	-20.0	-9.5
REMOTE CONTROL UNIT- PLSS	81001.		1	LWR. BOOT BOX	5.1	273.8	-20.0	-9.5
CRT./CAN. PLSS LIGHT REPLACEMENT	81003.		2	ISA(OVER AS ENG CVR)	13.4	280.0	.0	-10.0
BAG, PLSS FEEDWATER COLLECTION	81026.		2	ISA(OVER AS ENG CVR)	.8	280.0	.0	-10.0
BAG, PLSS FEEDWTR. CGL. W/O SCALE	81026.		1	ISA(OVER AS ENG CVR)	.5	280.0	.0	-10.0
URINE BAGS	03009.		2	ISA(OVER AS ENG CVR)	.6	280.0	.0	-10.0
BAG, LUNAR EQUIPMENT TRANSFER	03018.		1	CAB FLOOR, FORWARD	.9	221.7	.0	37.5
HAMMOCK-COR	03048.		1	ISA(OVER AS ENG CVR)	4.1	280.0	.0	-10.0
HAMMOCK-LMP	03050.		1	ISA(OVER AS ENG CVR)	3.9	280.0	.0	-10.0
BATTERY, PLSS	81004.		1	ISA(OVER AS ENG CVR)	5.5	280.0	.0	-10.0
BATTERY, PLSS	81004.		1	ISA(OVER AS ENG CVR)	5.5	280.0	.0	-10.0
BUDDY SLSS ASSY	81052.		1	CAB FLOOR, FORWARD	10.9	221.7	.0	37.5
PLSS/EVC ASSY- LMP	81025.		1	PLSS DONNING STA.	83.0	275.0	-5.0	19.2
CAMERA L.S. ELECT. HASSELBLAD	A1015.		1	CAB FLOOR, FORWARD	3.1	221.7	.0	37.5
CAMERA L.S. ELECT. HASSELBLAD	A1015.		1	CAB FLOOR, FORWARD	3.1	221.7	.0	37.5
MAG, 70MM L.S. HASSELBLAD	A0109. 1		2	CAB FLOOR, FORWARD	2.8	221.7	.0	37.5
MAG, 70MM L.S. HASSELBLAD	A0109. 1		1	CAB FLOOR, FORWARD	1.4	221.7	.0	37.5
MAGAZINE, 16MM DATA ACQUISITION	A0101. 1		1	CAB FLOOR, FORWARD	1.0	221.7	.0	37.5
MAGAZINE, 16MM DATA ACQUISITION	A0101. 1		2	CAB FLOOR, FORWARD	2.0	221.7	.0	37.5
DISPOSAL CONTAINER	03012.		1	ISA(OVER AS ENG CVR)	1.8	280.0	.0	-10.0
LENS/SCRIBE/BRUSH	TBD		1	CAB FLOOR, FORWARD	.3	221.7	.0	37.5
POLARIZING FILTER	A1005.		1	CAB FLOOR, FORWARD	.2	221.7	.0	37.5
LM ECS CARTRIDGE +BRACKET	03008.		1	ISA(OVER AS ENG CVR)	9.2	280.0	.0	-10.0
OXYGEN PURGE SYSTEM	81012. 2		1	DN CABIN FLOOR-OPS	35.0	219.7	.0	44.7
OXYGEN PURGE SYSTEM	91012. 2		1	DN CABIN FLOOR-OPS	35.0	219.7	.0	44.7
LENS, 60 MM L.S.E.H.	A1016.		1	CAB FLOOR, FORWARD	1.8	221.7	.0	37.5
LENS, 60 MM L.S.E.H.	A1016.		1	CAB FLOOR, FORWARD	1.8	221.7	.0	37.5
TRIGGER, L.S.E.H.	A1027.		1	CAB FLOOR, FORWARD	.2	221.7	.0	37.5
TRIGGER, L.S.E.H.	A1027.		1	CAB FLOOR, FORWARD	.2	221.7	.0	37.5
HANDLE, L.S.E.H.	A1028.		1	CAB FLOOR, FORWARD	.5	221.7	.0	37.5
HANDLE, L.S.E.H.	A1028.		1	CAB FLOOR, FORWARD	.5	221.7	.0	37.5

NOTE: Further information relating to this table is given on pages 3.4-19, 3.4-20 and 3.4-21.

Table 3.4-9.2 (Continued)

LM-9 EMERGENCY LIFTOFF TRANSFERABLE EQUIPMENT LIST								
ITEMS REARRANGED IN ASCENT STAGE PRE EVA 2 FOR EMERGENCY LIFTOFF								
DESCRIPTION	STOW. ITEM	REF	NO.	STOWAGE LOCATION	WEIGHT	X-C.G.	Y-C.G.	Z-C.G.
BRACKET, CAMERA MOUNT	81001. 1		1	CAB FLOOR, FOWARD	.6	221.7	.0	37.5
BRACKET, CAMERA MOUNT	81001. 1		1	CAB FLOOR, FOWARD	.6	221.7	.0	37.5
KIT,EMU MAINTENANCE	81016.		1	ISA(OVER AS ENG CVR)	.5	280.0	.0	-10.0
PURGE VALVE ASSY	81017.		1	ISA(OVER AS ENG CVR)	.5	280.0	.0	-10.0
PURGE VALVE ASSY	81017.		1	ISA(OVER AS ENG CVR)	.5	280.0	.0	-10.0
SAMPLE SCALE	G4031.			ISA(OVER AS ENG CVR)	1.5	280.0	.0	-10.0
PRE EVA 2 REANG.					243.40	253.20	-2.54	21.93

NOTE: Further information relating to this table is given on pages 3.4-19, 3.4-20 and 3.4-21.

Table 3.4-9.2 (Continued)

LM-8 EMERGENCY LIFTOFF TRANSFERABLE EQUIPMENT LIST								
ITEMS OFFLOADED AT LUNAR SITE DURING EVA 2								
LM COORDINATES								
DESCRIPTION	STOW. ITEM	REF	NO.	STORAGE LOCATION	WEIGHT	X-C.G.	Y-C.G.	Z-C.G.
CRT./CAN,PLSS LIQH(REPLACEMENT	B1003.		2	FLIGHT DATA FILE CTR	13.4	280.8	-20.0	14.0
BAG,PLSS FEEDWATER COLLECTION	B1026.		2	LH SIDE STOW.COMPT.	.8	235.0	-34.0	45.0
BAG,PLSS FEEDWTR.COL.W/O SCALE	B1026.		1	LH SIDE STOW.COMPT.	.5	235.0	-34.0	45.0
URINE BAGS	03009.		2	RH SIDE STOW.COMPT.	.6	238.4	38.6	46.0
BAG,LUNAR EQUIPMENT TRANSFER	03018.		1	R.H.CAB.FLOOR,FOWARD	.9	221.7	24.0	60.5
HAMMOCK-COR	03048.		1	LH SIDE STOW.COMPT.	4.1	235.0	-34.0	45.0
HAMMOCK-LMP	03050.		1	LH SIDE STOW.COMPT.	3.9	235.0	-34.0	45.0
BATTERY, PLSS	B1004.		1	LH SIDE STOW.COMPT.	5.5	235.0	-34.0	45.0
BATTERY, PLSS	B1004.		1	LH SIDE STOW.COMPT.	5.5	235.0	-34.0	45.0
BUDDY SLSS ASSY	B1052.		1	ON PLUS Z27 BHD	10.9	260.0	-37.0	28.0
LM LUNAR SURFACE MAPS	A1008. 5		1	ETB (RH FLOOR,FWD)	1.7	221.7	24.0	60.5
LM FOOD WASTE	C1000		1	FOOD CONTAINER NO.1	2.3	279.8	-20.0	.0
LM FOOD WASTE	C1000.		1	FOOD CONTAINER NO.2	3.0	273.8	-20.0	.0
CAMERA L.S. ELECT. HASSELBLAD	A1015.		1	ETB (RH FLOOR,FWD)	3.1	221.7	24.0	60.5
CAMERA L.S. ELECT. HASSELBLAD	A1015.		1	ETB (RH FLOOR,FWD)	3.1	221.7	24.0	60.5
MAG, 70MM L.S. HASSELBLAD	A0108. 1		2	ETB (RH FLOOR,FWD)	2.8	221.7	24.0	60.5
MAG, 70MM L.S. HASSELBLAD	A0108. 1		1	RH SIDE STOW.COMPT.	1.4	238.4	38.6	46.0
MAGAZINE, 16MM DATA ACQUISITON	A0101. 1		1	ETB (RH FLOOR,FWD)	1.0	221.7	24.0	60.5
MAGAZINE, 16MM DATA ACQUISITON	A0101. 1		2	ETB (RH FLOOR,FWD)	2.0	221.7	24.0	60.5
DISPOSAL CONTAINER	03012.		1	LH SIDE STOW.COMPT.	1.8	235.0	-34.0	45.0
LENS/SCRIBE/BRUSH	T8D		1	ETB (RH FLOOR,FWD)	.3	221.7	24.0	60.5
POLARIZING FILTER	A1005.		1	RH SIDE STOW.COMPT.	.2	238.4	38.6	46.0
LM ECS CARTRIDGE +BRACKET	03008.		1	AFT OF ASC.ENG.COVER	9.2	245.8	8.8	-15.0
LENS,60 MM L.S.E.H.	A1016.		1	ETB (RH FLOOR,FWD)	1.8	221.7	24.0	60.5
LENS,60 MM L.S.E.H.	A1016.		1	ETB (RH FLOOR,FWD)	1.8	221.7	24.0	60.5
TRIGGER, L.S.E.H.	A1027.		1	ETB (RH FLOOR,FWD)	.2	221.7	24.0	60.5
TRIGGER, L.S.E.H.	A1027.		1	ETB (RH FLOOR,FWD)	.2	221.7	24.0	60.5
HANDLE, L.S.E.H.	A1028.		1	ETB (RH FLOOR,FWD)	.5	221.7	24.0	60.5
HANDLE, L.S.E.H.	A1028.		1	ETB (RH FLOOR,FWD)	.5	221.7	24.0	60.5
BRACKET, CAMERA MOUNT	B1001. 1		1	ETB (RH FLOOR,FWD)	.6	221.7	24.0	60.5
BRACKET, CAMERA MOUNT	B1001. 1		1	ETB (RH FLOOR,FWD)	.6	221.7	24.0	60.5
ECS LIQH STRAP	03024.		1	AFT OF ASC.ENG.COVER	.1	245.8	8.8	-15.0
EVA 2 OFFLOAD					84.30	246.07	-10.15	32.33

NOTE: Further information relating to this table is given on pages 3.4-19, 3.4-20 and 3.4-21.

Table 3.4-9.2 (Continued)

LM-8 EMERGENCY LIFTOFF TRANSFERABLE EQUIPMENT LIST								
ITEMS UNLOADED INTO ASCENT STAGE DURING EVA2								
LM COORDINATES								
DESCRIPTION	STOW. ITEM	REF	NO.	STOWAGE LOCATION	WEIGHT	X-C.G.	Y-C.G.	Z-C.G.
BAG, LUNAR EQUIPMENT TRANSFER	U3018.		1	ISA(OVER AS ENG CVR)	.9	280.0	.0	-10.0
LM LUNAR SURFACE MAPS	A1008. 5		1	FLIGHT DATA FILE CTR	1.7	280.8	-20.0	14.0
CAMERA L.S. ELECT. HASSELBLAD	A1015.		1	RH SIDE STOW.COMPT.	3.1	238.4	38.6	46.0
MAG, 70MM L.S. HASSELBLAD	A0109. 1		2	RH SIDE STOW.COMPT.	2.8	238.4	38.6	46.0
MAG, 70MM L.S. HASSELBLAD	A0109. 1		1	ISA(OVER AS ENG CVR)	1.4	280.0	.0	-10.0
MAGAZINE, 16MM DATA ACQUISITION	A0101. 1		1	RH SIDE STOW.COMPT.	1.0	238.4	38.6	46.0
MAGAZINE, 16MM DATA ACQUISITION	A0101. 1		2	RH SIDE STOW.COMPT.	2.0	238.4	38.6	46.0
SAMPLE CONTAINER, MAGNETIC SHD	G4039.		1	ISA(OVER AS ENG CVR)	1.0	280.0	.0	-10.0
CASSETTE, CLGSE-UP CAMERA(CSC)	J1001.		1	ISA(OVER AS ENG CVR)	.5	280.0	.0	-10.0
CONTNR. SAMPL. RET. NO.2 (LOD)	G4004.		1	SRC RACK NO.2-UPR.	65.0	265.9	-20.7	-6.0
SOLAR WIND COMPOSITION EXPR.	G4011.		1	ISA(OVER AS ENG CVR)	.3	280.0	.0	-10.0
SAMPLES, THERMO COAT. DEGRAD.	F1002.		2	ISA(OVER AS ENG CVR)	.8	280.0	.0	-10.0
WEIGH BAG WITH FOOTBALL STR.RK	G4018.		1	ISA(OVER AS ENG CVR)	30.0	280.0	.0	-10.0
LENS, 60 MM L.S.E.H.	A1016.		1	RH SIDE STOW.COMPT.	1.8	238.4	38.6	46.0
TRIGGER, L.S.E.H.	A1027.		1	ISA(OVER AS ENG CVR)	.2	280.0	.0	-10.0
HANDLE, L.S.E.H.	A1023.		1	ISA(OVER AS ENG CVR)	.5	280.0	.0	-10.0
BRACKET, CAMERA MOUNT	R1001. 1		1	ISA(OVER AS ENG CVR)	.6	280.0	.0	-10.0
SESC(CONT.SAMPLES)	G4040.		1	LH SIDE STOW.COMPT.	1.0	235.0	-34.0	45.0
BAG, SAMPLE RETURN	03060.			ON PLUS 227 BHD	35.0	260.0	-37.0	28.0
EVA 2 UNLOAD					149.60	265.93	-15.34	5.27

NOTE: Further information relating to this table is given on pages 3.4-19, 3.4-20 and 3.4-21.

Table 3.4-9.2 (Continued)

LM-8 EMERGENCY LIFTOFF TRANSFERABLE EQUIPMENT LIST								
ITEMS REARRANGED IN ASCENT STAGE PRE DEPRES. FOR EMERGENCY LIFTOFF								
DESCRIPTION	STOW. ITEM	REF	NO.	STOWAGE LOCATION	WEIGHT	X-C.G.	Y-C.G.	Z-C.G.
REMOTE CONTROL UNIT- PLSS	B1001.		1	ON MINUS 227 BHD-RCU	5.1	280.0	.0	-21.5
REMOTE CONTROL UNIT- PLSS	B1001.		1	ON MINUS 227 BHD-RCU	5.1	280.0	.0	-21.5
ARM RESTS - CDR	T60		1	LH CREW STA-INSTAL.	1.1	282.5	-6.5	51.0
URINE BAG	O3009.		1	RH SIDE STOW.COMPT.	.3	238.4	38.6	46.0
CONTAINER, PLSS CONDENSATE	O3014.		1	LH MID-SECTION AREA	4.4	264.8	-13.0	15.0
BOOTS, LUNAR (PR.)-CDR	B1018.		1	UPR.BOOT BOX	4.5	280.8	-20.0	-9.5
BOOTS, LUNAR (PR.)	B1018.		1	LWR.BOOT BOX	4.5	273.8	-20.0	-9.5
TETHER, EVA RETRACTABLE-CDR	A1029		1	ON CDR PLSS(RECHG ST	.2	262.8	-20.8	15.4
TETHER, EVA RETRACTABLE-LMP	A1029		1	ON LMP PLSS(CBN.FLR)	.2	219.7	.0	44.7
PLSS/EVC ASSY- LMP	B1025.		1	ON CABIN FLOOR-PLSS	83.0	219.7	.0	44.7
CAMERA L.S. ELECT. HASSELBLAD	A1015.		1	RH SIDE STOW.COMPT.	3.1	238.4	38.6	46.0
MAGAZINE, 16MM DATA ACQUISITON	A0101. 1		1	RH SIDE STOW.COMPT.	1.0	238.4	38.6	46.0
MAGAZINE, 16MM DATA ACQUISITON	A0101. 1		2	RH SIDE STOW.COMPT.	2.0	238.4	38.6	46.0
DISPOSAL CONTAINER	O3012.		1	LH SIDE STOW.COMPT.	1.8	235.0	-34.0	45.0
OXYGEN PURGE SYSTEM	B1012. 2		1	SRC RACK NO.1-LWR.	35.0	257.4	-20.7	-6.0
OXYGEN PURGE SYSTEM	B1012. 2		1	SRC RACK NO.2-UPR.	35.0	265.9	-20.7	-6.0
SESC(CONT.SAMPLES)	G4040.		1	LH SIDE STOW.COMPT.	1.0	235.0	-34.0	45.0
KIT,EMU MAINTENANCE	B1016.		1	HSB/LH(ON CABIN FLR)	.5	221.0	-18.3	53.0
PURGE VALVE ASSY	B1017.		1	UPR.BOOT BOX	.5	280.8	-20.0	-9.5
PURGE VALVE ASSY	B1017.		1	LWR.BOOT BOX	.5	273.8	-20.0	-9.5
SAMPLE SCALE	G4031.			LH SIDE STOW.COMPT.	1.5	235.0	-34.0	45.0
PRE DEPPES.WEANG					190.30	243.82	-8.54	19.05

NOTE: Further information relating to this table is given on pages 3.4-19, 3.4-20 and 3.4-21.

Table 3.4-9.2 (Continued)

LM-8 EMERGENCY LIFTOFF TRANSFERABLE EQUIPMENT LIST								
ITEMS REARRANGED IN ASCENT STAGE PRE DEPPES. FOR EMERGENCY LIFTOFF								
DESCRIPTION	STOW. ITEM	REF	NO.	STORAGE LOCATION	WEIGHT	X-C.G.	Y-C.G.	Z-C.G.
REMOTE CONTROL UNIT- PLSS	B1001.		1	CAB FLOOR, FOWARD	5.1	221.7	.0	37.5
REMOTE CONTROL UNIT- PLSS	B1001.		1	CAB FLOOR, FOWARD	5.1	221.7	.0	37.5
ARM RESTS - CDR	T6D		1	CAB FLOOR, FOWARD	1.1	221.7	.0	37.5
URINE BAG	03009.		1	CAB FLOOR, FOWARD	.3	221.7	.0	37.5
CONTAINER, PLSS CONDENSATE	03014.		1	CAB FLOOR, FOWARD	4.4	221.7	.0	37.5
BOOTS, LUNAR (PR.)-CDR	B1018.		1	CAB FLOOR, FOWARD	4.5	221.7	.0	37.5
BOOTS, LUNAR (PR.)	B1018		1	CAB FLOOR, FOWARD	4.5	221.7	.0	37.5
TETHER, EVA RETRACTABLE-CDR	A1029		1	CAB FLOOR, FOWARD	.2	221.7	.0	37.5
TETHER, EVA RETRACTABLE-LMP	A1029		1	CAB FLOOR, FOWARD	.2	221.7	.0	37.5
PLSS/EVC ASSY- LMP	B1025.		1	PLSS DONNING STA.	83.0	275.0	-5.0	19.2
CAMERA L.S. ELECT. HASSELBLAD	A1015.		1	ISA(OVER AS ENG CVR)	3.1	280.0	.0	-10.0
MAGAZINE, 16MM DATA ACQUISITION	A0101. 1		1	ISA(OVER AS ENG CVR)	1.0	280.0	.0	-10.0
MAGAZINE, 16MM DATA ACQUISITION	A0101. 1		2	ISA(OVER AS ENG CVR)	2.0	280.0	.0	-10.0
DISPOSAL CONTAINER	03012.		1	CAB FLOOR, FOWARD	1.8	221.7	.0	37.5
OXYGEN PURGE SYSTEM	B1012. 2		1	ON CABIN FLOOR-OPS	35.0	219.7	.0	44.7
OXYGEN PURGE SYSTEM	B1012. 2		1	ON CABIN FLOOR-OPS	35.0	219.7	.0	44.7
SESC (CONT. SAMPLES)	G4040.		1	ISA(OVER AS ENG CVR)	1.0	280.0	.0	-10.0
KIT, EMJ MAINTENANCE	B1016.		1	ISA(OVER AS ENG CVR)	.5	280.0	.0	-10.0
PURGE VALVE ASSY	B1017.		1	ISA(OVER AS ENG CVR)	.5	280.0	.0	-10.0
PURGE VALVE ASSY	B1017.		1	ISA(OVER AS ENG CVR)	.5	280.0	.0	-10.0
SAMPLE SCALE	G4031.		1	ISA(OVER AS ENG CVR)	1.5	280.0	.0	-10.0
PRE DEPRES.REANG					190.30	247.31	-2.18	29.65

NOTE: Further information relating to this table is given on pages 3.4-19, 3.4-20 and 3.4-21.

Table 3.4-9.2 (Continued)

L ₄ -4 EMERGENCY LIFTOFF TRANSFERABLE EQUIPMENT LIST								
ITEMS OFFLOADED AT FINAL DEPRESSURIZATION								
DESCRIPTION	STOW. ITEM	REF	NO.	STOWAGE LOCATION	WEIGHT	X-C.G.	Y-C.G.	Z-C.G.
REMOTE CONTROL UNIT- PLSS	81001.		1	ON MINUS 227 BMD-RCU	5.1	280.0	.0	-21.5
REMOTE CONTROL UNIT- PLSS	81001.		1	ON MINUS 227 BMD-RCU	5.1	280.0	.0	-21.5
ARM RESTS - CDR	T8D		1	LH CREW STA-INSTAL.	1.1	282.5	-6.5	51.0
URINE BAG	03009.		1	RH SIDE STOW.COMPT.	.3	238.4	38.6	46.0
CONTAINER, PLSS CONDENSATE	03014.		1	LH MID-SECTION AREA	4.4	264.8	-13.0	15.0
BOOTS, LUNAR (PR.)-C/P	91018.		1	UPR. BOOT BOX	4.5	280.8	-20.0	-9.5
BOOTS, LUNAR (PR.)	91018.		1	LWR. BOOT BOX	4.5	273.8	-20.0	-9.5
TETHER, EVA RETRACTABLE-CDP	A1029		1	ON CDR PLSS(RECHG ST	.2	262.8	-20.8	15.4
TETHER, EVA RETRACTABLE-LMP	A1029		1	ON LMP PLSS(CBN.FLR)	.2	219.7	.0	44.7
PLSS/EVC ASSY- CDR	81024.		1	RECHARGE STA.-PLSS	83.1	262.8	-20.8	15.4
PLSS/EVC ASSY- LMP	81025.		1	ON CABIN FLOOR-PLSS	83.0	219.7	.0	44.7
DISPOSAL CONTAINER	03012.		1	LH SIDE STOW.COMPT.	1.8	235.0	-34.0	45.0
FINAL OFFLOAD					193.30	245.69	-10.48	25.42

NOTE: Further information relating to this table is given on pages 3.4-19, 3.4-20 and 3.4-21.

TABLE 3.4-10
CONSUMABLES LOADING REQUIREMENTS AND TOLERANCES

Mission H-3

SPS Propellant

Pressure (PSIA)		Temperature (°F)		Quantity Readout (Σ)	
Fuel	Oxidiser	Fuel	Oxidiser	Fuel	Oxidiser
110±4	110±4	70±5	70±5	See Figure 4.1-3	See Figure 4.1-4

SPS Propellant Load (lb)	Loading Requirement		Actual	
	Fuel	Oxidiser	Fuel	Oxidiser
¹ Load	15704.0	25092.0		
² Trapped Outside Tanks Tanked	78.6	123.7		
² Trapped Inside Tanks	15625.4	24968.3		
³ Nominal Deliverable	67.6	171.5		
	15557.8	24796.8		

⁴Service Module RCS Propellant

Secondary Fuel - Quade A, B, C, D - See Loading Window - Figure 4.3-1.

Primary Fuel - Quade A, B, C, D - See Loading Window - Figure 4.3-2.

Primary and Secondary Oxidiser - Quads A, B, C, D - See Loading Window - Figure 4.3-3.

⁵Command Module RCS Propellant

Fuel - System A and B - See Loading Window - Figure 4.3-4.

Oxidiser - System A and B - See Loading Window - Figure 4.3-5.

⁹Helium and Nitrogen

Consumable	Loading Requirement				Actual	
	Pressure (PSIA)	Temp (°F)	Weight (lb)	Earth Launch Weight (lb)	Pressure (PSIA)	Temp (°F)
Helium - SPS Bottles	3600	70	87.6	87.6		
Helium - Fuel Tanks	178	70	5.4			
Helium - N ₂ O ₄ Tanks	178	70				
Helium - SM/RCS						
Quad A	4150	70				
Quad B	4150	70				
Quad C	4150	70	6.0	6.0		
Quad D	4150	70				
Helium - CM/RCS						
System A	4150	70	1.0	1.0		
System B	4150	70				
Nitrogen - SM						
Primary	2500	85	1.3	1.3		
Secondary	2500	85				



Command Module Water and GOX

	Pressure (PSIA)	Loading Requirement Weight (lb)	Earth Launch Weight (lb)	Actual
Waste Water ⁶			18.0	
Potable Water ⁷			36.0	
CM/GOX	900±50	3.7	6.7 (Entry)	

⁸Service Module Hydrogen and Oxygen

	Loading Requirement (pounds)	Earth Launch Weight (pounds)
Hydrogen		
Tank 1	29.3	27.6
Tank 2	29.3	27.6
Oxygen		
Tank 1	330.1	316.6
Tank 2	330.1	316.6
Tank 3	330.1	198.1

NOTES:

¹Indicated propellant load is based on nominal pressure and temperature prior to actual loading. This number will be updated after loading is accomplished.

²See Section 4.1 for explanation of trapped SPS propellant.

³See Table 3.4-13 for loading uncertainties.

⁴See Section 4.2 for SM/RCS loads and uncertainties to be used in Mission Planning. Actual SM/RCS loads and uncertainties will be published in Table 3.4-15.

⁵See Section 4.2 for CM/RCS loads and uncertainties to be used in Mission Planning. Actual CM/RCS loads and uncertainties will be published in Table 3.4-14.

⁶Launch Rule Redlines determine lift-off values.

⁷Launch Rule Redlines determine lift-off values.

⁸Launch Mission Rules will determine minimum lift-off quantities for H₂ and O₂.

⁹CSM helium and nitrogen should be loaded in accordance with loading windows contained in CSM/LM Spacecraft Operational Data Book, Volume I, Part 2, SNA-8-D-027(1) P2.



TABLE 3.4-12

Mission H-3 SPS Propellant Load Parameters
(To be provided by KSC following loading)

<u>Fuel</u>		<u>Oxidizer</u>	
Adjusted quantity fuel readout - Percent	_____	Adjusted quantity oxidizer readout - Percent	_____
Fuel storage voltage reading taken from ACE to three significant digits - volts	_____	Oxidizer storage voltage reading taken from ACE to three significant digits - volts	_____
Fuel sump voltage reading taken from ACE to three significant digits - volts	_____	Oxidizer sump voltage reading taken from ACE to three significant digits - volts	_____

Enter the following information at Sump Tank Full Adjust
(Propellant at top of standpipe)

<u>Fuel</u>		<u>Oxidizer</u>	
Fuel sump tank pressure - PSIA	_____	Oxidizer sump tank pressure - PSIA	_____
Fuel temperature - °F	_____	Oxidizer temperature - °F	_____
Adjusted quantity fuel readout - Percent	_____	Adjusted quantity oxidizer readout - %	_____
Fuel sump voltage reading taken from ACE to three significant digits - volts	_____	Oxidizer sump voltage reading taken from ACE to three significant digits - volts	_____

Enter the following information at Storage Tank Full Adjust
(Propellant at Point Sensor #1)

<u>Fuel</u>		<u>Oxidizer</u>	
Fuel storage tank pressure - PSIA	_____	Oxidizer storage tank pressure - PSIA	_____
Fuel temperature - °F	_____	Oxidizer temperature - °F	_____
Adjusted quantity fuel readout - %	_____	Adjusted quantity oxidizer readout - %	_____
Fuel storage voltage reading taken from ACE to three significant digits - volts	_____	Oxidizer storage voltage reading taken from ACE to three significant digits - volts	_____
Fuel sump voltage reading taken from ACE to three significant digits - volts	_____	Oxidizer sump voltage reading taken from ACE to three significant digits - volts	_____

TABLE 3.4-12 (Continued)

Enter the following information when tanking is complete (110±5 PSIA) Time			
<u>Fuel</u>		<u>Oxidizer</u>	
a. System pressure - PSIA	_____	a. System pressure - PSIA	_____
b. Fuel temperature - °F	_____	b. Oxidizer temperature - °F	_____
c. Quantity fuel readout - %	_____	c. Quantity oxidizer readout - %	_____
d. Fuel measured specific gravity @ °C - 14.7 PSIA	_____	d. Oxidizer measured specific gravity @ °C - 14.7 PSIA	_____
e. Fuel measured density °C - 14.7 PSIA (Item d times 62.428) - lb/ft ³	_____	e. Oxidizer measured density @ °C - 14.7 PSIA (Item d times 62.428) - lb/ft ³	_____
f. Calculated density - lb/ft ³ - at system pressure and temperature. Items a and b above. Use density equation outlined in Section 4.1.	_____	f. Calculated density - lb/ft ³ - at system pressure and temperature. Item a and b above. Use density equation outlined in Section 4.1.	_____
g. Fuel storage voltage reading from ACE	_____	g. Oxidizer storage voltage reading from ACE	_____
h. Fuel sump voltage reading from ACE	_____	h. Oxidizer sump voltage reading from ACE	_____

Enter the following information at leak check pressure			
<u>Fuel</u>		<u>Oxidizer</u>	
System pressure - PSIA	_____	System pressure - PSIA	_____
Quantity fuel readout - %	_____	Quantity oxidizer readout - %	_____
Fuel storage voltage reading from ACE	_____	Oxidizer storage voltage readout from ACE	_____
Fuel sump voltage reading from ACE	_____	Oxidizer sump voltage readout from ACE	_____

TABLE 3.4-13
SPS PROPELLANT UNCERTAINTIES

ITEM	FUEL (lb)	OXIDIZER (lb)
<u>LOADING UNCERTAINTIES</u>		
Tank Volume	+24	+39
Temperature Gauge (+2.0°F)	+18	+46
Standpipe Height	+ 6	+10
Propellant Gauge (+0.35% of Gaugeable)	+54	+86
Density Measurement (1)	+ 0	+ 0
Batch Density (1)	+94	+75
Loading Pressure (1)	+ 8	+14
RSS	+113	+130
TOTAL RSS	+172	
Loading Specification (1) (2)	+16	+24
Tolerance on Propellant Temperature of Flight Load	+0.0 -46.0	+0.0 -113.0
TOTAL LOADING UNCERTAINTY	+212 -371	
<u>MISSION UNCERTAINTIES</u>		
Mixture Ratio Variation	TBD	
ΔV , I_{sp} , Vehicle Weight Variation	TBD	
Propellant usage uncertainty due to total loading uncertainty	TBD	
TOTAL PROPELLANT UNCERTAINTY FOR MISSION ΔV	TBD	

- NOTES: (1) Data will be known after loading is accomplished.
- (2) Loading specification is an allowable tolerance about nominal, this number is added to the loading uncertainty variables.

U U

TABLE 3.4-14

Command Module RCS Loading Parameters and Calculations

This table will be completed when loading is accomplished. For Mission Planning, reference should be made to Section 4.2 for nominal load, loading tolerances, trapped and deliverable propellants.

	<u>FUEL</u>		<u>OXIDIZER</u>	
	<u>Tank A</u>	<u>Tank B</u>	<u>Tank A</u>	<u>Tank B</u>
A. Tank Volume @ 0.0 PSIA (in ³)	_____	_____	_____	_____
B. Liquid Line Volume (in ³)	_____	_____	_____	_____
C. Total A + B (in ³)	_____	_____	_____	_____
D. Initial Weight in Bleed Unit Prior to Loading (lb)	_____	_____	_____	_____
E. Final Weight in Bleed Unit After Loading (lb)	_____	_____	_____	_____
F. Propellant Load (item D less than E Weigh Tank)	_____	_____	_____	_____
G. Propellant Load by P.V.	_____	_____	_____	_____
H. Loading Temperature (°F)	_____	_____	_____	_____
I. Specification Propellant Load @ 70±5°F (lb)	_____	_____	_____	_____
J. Total CM/RCS Propellant Load from Item G above (lb)	_____	_____	_____	_____
K. Maximum Trapped Propellant (lb)	_____	_____	_____	_____
L. Nominal Deliverable (lb)	_____	_____	_____	_____



TABLE 3.4-15

SERVICE MODULE RCS LOADING SUMMATION

This table will be completed when loading is accomplished. For Mission Planning, reference should be made to Section 4.2, for nominal load, loading tolerances, and nominal deliverable propellants.

<u>Quad A (lb)</u>		<u>Quad B (lb)</u>	
Secondary fuel	_____	Secondary fuel	_____
Primary fuel	_____	Primary Fuel	_____
Total fuel	_____ ±0.7	Total fuel	_____ ±0.7
Maximum Trapped	<u>2.1</u>	Maximum Trapped	<u>2.1</u>
Nominal Deliverable	_____	Nominal Deliverable	_____
Total Oxidizer	_____ ±2.3	Total Oxidizer	_____ ±2.3
Maximum Trapped	<u>4.5</u>	Maximum Trapped	<u>4.5</u>
Nominal Deliverable	_____	Nominal Deliverable	_____
<u>Quad C (lb)</u>		<u>Quad D (lb)</u>	
Secondary fuel	_____	Secondary fuel	_____
Primary fuel	_____	Primary fuel	_____
Total fuel	_____ ±0.7	Total fuel	_____ ±0.7
Maximum Trapped	<u>2.1</u>	Maximum Trapped	<u>2.1</u>
Nominal Deliverable	_____	Nominal Deliverable	_____
Total Oxidizer	_____ ±2.3	Total Oxidizer	_____ ±2.3
Maximum Trapped	<u>4.5</u>	Maximum Trapped	<u>4.5</u>
Nominal Deliverable	_____	Nominal Deliverable	_____
<u>Total SM/RCS Propellant Load (lb)</u>			
Total fuel	_____ ±1.4	Total Oxidizer	_____ ±4.6
Maximum Trapped	<u>8.4</u>	Maximum Trapped	<u>18.0</u>
Nominal Deliverable	_____	Nominal Deliverable	_____



LM-8 Consumable Loading Requirements
LM-8 APS Propellant

	<u>Fuel (lb)</u>	<u>Oxidizer (lb)</u>
Propellant Load	2006.7	3218.1
Trapped Outside Tanks	5.9	8.3
Tanked	2000.8	3209.8
Trapped Inside Tanks	10.1	27.6
Nominal Deliverable	1990.7	3182.2
Outage	TBD	TBD
Total APS Propellant	TBD	TBD

The following table should be used to determine the amount of propellant to be off-loaded from a full condition to arrive at the indicated load. The allowable tolerance for the calculated off-load is ± 0.5 pounds per weigh tank.

A. Final tank pressure at overfill (PSIG)	_____	_____
B. Propellant loading temperature (°F)	_____	_____
C. Nominal overfill quantity (lb)	2072.3	3307.2
D. Correction for tank pressure (lb)	_____	_____
Δ Fuel = 0.09 (Item A-40)		
Δ Oxidizer = 0.15 (Item A-40)		
¹ E. Correction for loading temperature (lb)		
Δ Fuel = -1.16 (Item B-65)		
Δ Oxidizer = -2.84 (Item B-65)		
² F. Measured density (GM/CC)	_____	_____
² G. Nominal density (GM/CC)	0.8994	1.4824
H. Delta density (GM/CC) (Item F-G)	_____	_____
³ I. Correction for measured density		
Δ Fuel = 2300 (Item H)		
Δ Oxidizer = 2300 (Item H)		
J. Propellant in GSE	_____	_____
K. Overfill quantity (C+D+E+I+J)	_____	_____
L. Target loading	2006.7	3218.1
M. Quantity required to fill RCS manifolds	_____	_____
N. Quantity to be off-loaded (Items K-L-M)	_____	_____

NOTES:

¹Loading temperature correction will always be negative.

²To calculate the nominal density solve the following equation where T= temperature in °C of the measured density (usually 4°C for oxidizer and 25°C for fuel). This equation is valid for 14.7 PSIA. Therefore, the measured density must also be at 14.7 PSIA.

Nominal fuel density = $0.922904 - 0.0009377 (°C)$

Nominal oxidizer density = $1.491539 - 0.0022832 (°C)$

³Correction for measured density may be either positive or negative.



LM-8 Consumable Loading Requirements

LM-8 DPS Propellant

	<u>Fuel (lb)</u>	<u>Oxidizer (lb)</u>
Propellant Load	<u>7072.8</u>	<u>11341.9</u>
Trapped Outside Tanks	<u>35.1</u>	<u>60.5</u>
Tanked	<u>7037.7</u>	<u>11281.4</u>
Trapped Inside Tanks	<u>14.8</u>	<u>102.7</u>
Nominal Deliverable	<u>7022.9</u>	<u>11178.7</u>
Outage	<u>TBD</u>	<u>TBD</u>
Total DPS Propellant Available	<u>TBD</u>	<u>TBD</u>

The following table should be used to determine the amount of propellant to be off-loaded from a full condition to arrive at the indicated load. The allowable tolerance for the calculated off-load is ± 0.5 pounds per weigh tank.

A1. Final tank pressure at overfill (PSIG)	_____	_____
B1. Propellant loading temperature (°F)	_____	_____
C1. Nominal overfill quantity (lb)	<u>7160.4</u>	<u>11452.9</u>
D1. Correction for tank pressure (lb)	_____	_____
Δ Fuel = 0.31 (Item A1-40)	_____	_____
Δ Oxidizer = 0.51 (Item A1-40)	_____	_____
¹ E1. Correction for loading temperature (lb)	_____	_____
Δ Fuel = -4.0 (Item B1-65)	_____	_____
Δ Oxidizer = -9.85 (Item B1-65)	_____	_____
² F1. Measured density (GM/CC)	_____	_____
² G1. Nominal density (GM/CC)	<u>0.8994</u>	<u>1.4824</u>
H1. Delta density (GM/CC) (Item F1-Item G1)	_____	_____
³ I1. Correction for measured density	_____	_____
Δ Fuel = 7900 (Item H1)	_____	_____
Δ Oxidizer = 7900 (Item H1)	_____	_____
J1. Propellant in GSE	_____	_____
K1. Overfill quantity (C1+D1+E1+I1+J1)	_____	_____
L1. Target loading	<u>7072.8</u>	<u>11341.9</u>
M1. Quantity required to fill RCS manifolds (APS only)	<u>XXXXXX</u>	<u>XXXXXX</u>
N1. Quantity to be off-loaded (Items K1-L1-M1)	_____	_____

NOTES:

¹Loading temperature correction will always be negative.

²To calculate the nominal density solve the following equation where T=temperature in °C of the measured density (usually 4°C for oxidizer and 25°C for fuel). This equation is valid for 14.7 PSIA. Therefore, the measured density must also be at 14.7 PSIA.

Nominal fuel density = $0.922904 - 0.0009377 (°C)$

Nominal oxidizer density = $1.491539 - 0.0022832 (°C)$

³Correction for measured density may be either positive or negative.



TABLE 3.4-17
LOAD CALCULATION

<u>APS PROPELLANT</u>		<u>Fuel</u>	<u>Oxidizer</u>
1.	Full tank - Item K, Table 3.4-15 (lb)	_____	_____
¹ 2.	Density of off-load tables at loading temperature and pressure (lb/ft ³)	_____	_____
¹ 3.	Propellant volume (divide item 1 by item 2. (ft ³))	_____	_____
¹ 4.	Measured density (from Table 3.4-19) (lb/ft ³)	_____	_____
5	Resulting full tank load (lb)	_____	_____
6.	Off-load amount (lb)	_____	_____
7.	Propellant required to fill RCS manifolds (lb)	_____	_____
8.	Propellant load (lb)	_____	_____
<u>DPS PROPELLANT</u>			
9.	Full tank - Item K1 Table 3.4-16 (lb)	_____	_____
¹ 10.	Density of off-load tables at loading temperature and pressure (lb/ft ³)	_____	_____
¹ 11.	Propellant volume (divide Item 9 by Item 10)(ft ³)	_____	_____
¹ 12.	Measured density (from Table 3.4-19) (lb/ft ³)	_____	_____
13.	Resulting full tank load (lb)	_____	_____
14.	Off-load amount (lb)	_____	_____
15.	Propellant load (lb)	_____	_____

RCS PROPELLANT

P. V. Calculations

	<u>Fuel</u>		<u>Oxidizer</u>	
	<u>Tank A</u>	<u>Tank B</u>	<u>Tank A</u>	<u>Tank B</u>
A. GSE Volume (in ³)	_____	_____	_____	_____
B. Initial Ullage Pressure (PSIG)	_____	_____	_____	_____
C. Initial GSE Pressure (PSIG)	_____	_____	_____	_____
D. Final GSE - S/C Pressure (PSIG)	_____	_____	_____	_____
E. Ullage Volume (in ³) - Solve the following equation by substituting the values in the indicated steps.	_____	_____	_____	_____
Ullage Volume = $\frac{(D-C)(A)}{B-D}$				

NOTE: ¹These items will be completed only if a density sample is not made prior to loading. If a density sample is made prior to loading, then the items will be left blank.



TABLE 3.4-19

Amendment 78
3/9/70

LM-8 APS Propellant Loading Parameters
(To Be Completed by KSC at Loading)

	<u>Fuel</u>	<u>Oxidizer</u>
Loading Pressure - PSIA	_____	_____
Loading Temperature - Fill Line - Degrees F	TT 58 Fuel TT258 Oxidizer	_____
Loading Temperature - Return Line - Degrees F	TT 59 Fuel TT259 Oxidizer	_____
Loading Temperature - Tank - Degrees F	GP0718 Fuel GP1218 Oxidizer	_____
Number of Times Weigh Tank Used (Flow Meter Not Used)	_____	_____
Total Pounds Off-Loaded Using Weigh Tank (Flow Meter Not Used)	_____	_____
Pounds Off-Loaded Using Flow Meter (Weigh Tank Not Used)	_____	_____
Measured Fuel Density @ °C; @ PSIA GM/CC	_____	_____
Measured Oxidizer Density @ °C; @ PSIA GM/CC	_____	_____



LM-8 DPS Propellant Loading Parameters

	<u>Fuel</u>	<u>Oxidizer</u>
Loading Pressure - PSIA	_____	_____
Loading Temperature - Fill Line - Degrees F	_____	_____
	TT 58 Fuel	
	TT258 Oxidizer	
Loading Temperature - Return Line - Degrees F	_____	_____
	TT 59 Fuel	
	TT259 Oxidizer	
Loading Temperature - Tank One - Degrees F	_____	_____
	GQ3718 Fuel	
	GQ4218 Oxidizer	
Loading Temperature - Tank Two - Degrees F	_____	_____
	GQ3719 Fuel	
	GQ4219 Oxidizer	
Number of Times Weigh Tank Used (Flow Meter Not Used)	_____	_____
Total Pounds Off-Loaded Using Weigh Tank (Flow Meter Not Used)	_____	_____
Pounds Off-Loaded Using Flow Meter (Weigh Tank Not Used)	_____	_____
Measured Fuel Density @ °C; PSIA GM/CC	_____	_____
Measured Oxidizer Density @ °C; PSIA GM/CC	_____	_____



Table 3.4-20 presents CSM-110/LM-8 (docked) mass properties, in Apollo coordinates, as a function of spacecraft weight for the Hybrid SM/SPS burn.

Table 3.4-21 presents CSM-110/LM-8 (docked) mass properties, in Apollo coordinates, as a function of spacecraft weight for L.O.I. SM/SPS burn.

Table 3.4-22 presents the CSM-110/LM-8 (docked) mass properties, in Apollo coordinates as a function of spacecraft weight for the D.O.I. SM/SPS burn.

Table 3.4-23 presents the CSM-110 mass properties, in Apollo coordinates, as a function of CSM weight for the Circularization I SM/SPS burn.

Table 3.4-24 presents the CSM-110 mass properties, in Apollo coordinates, as a function of CSM weight for the Plane Change I SM/SPS burn.

Table 3.4-25 presents the CSM-110 mass properties, in Apollo coordinates, as a function of CSM weight for the T.E.I. SM/SPS burn.

Table 3.4-26 presents the LM-8 mass properties, in LM coordinates, as a function of LM weight for the P.D.I. DPS burn.

Table 3.4-27 presents the LM-8 ascent stage mass properties, in LM coordinates as a function of weight for the lunar lift-off APS burn.

Table 3.4-28 presents the LM-8 mass properties, in LM coordinates, as a function of LM weight for the T.P.I. burn.

U U

X(A) COORDINATES

TABLE 3.4-20

CSM-110/LM-8 HYBRID BURN

WEIGHT LBS.	X-BAR	Y-BAR INCHES	Z-BAR	IXX	IYY	IZZ SLUG-FT SQ	PXY	PXZ	PYZ	PITCH DEGREES	YAW	AVERAGE MOMENT	INERTIA/THRUST RATIO
98056.9	1038.29	2.59	4.03	57039	538046	540981	-8079	-9664	3433	1.025	-.226	539513	1.494
97056.9	1039.05	2.58	3.95	56516	536427	539795	-8066	-9553	3288	1.050	-.231	538111	1.484
96056.9	1039.89	2.57	3.88	55993	534523	538323	-8051	-9429	3142	1.074	-.237	536423	1.474
95056.9	1040.84	2.56	3.81	55470	532304	536538	-8035	-9290	2996	1.100	-.242	534421	1.461
94056.9	1041.88	2.56	3.73	54947	529742	534409	-8017	-9136	2850	1.126	-.248	532076	1.448
93056.9	1043.03	2.55	3.65	54424	526805	531906	-7998	-8967	2704	1.153	-.255	529355	1.432
92056.9	1044.28	2.54	3.57	53900	523459	528993	-7976	-8783	2558	1.181	-.261	526226	1.416
91056.9	1045.64	2.53	3.49	53376	519668	525636	-7953	-8582	2412	1.209	-.268	522652	1.397
90056.9	1047.11	2.52	3.40	52852	515394	521797	-7927	-8365	2266	1.238	-.276	518595	1.377
89056.9	1048.69	2.51	3.32	52327	510597	517435	-7900	-8131	2120	1.268	-.283	514016	1.354
88056.9	1050.39	2.50	3.23	51802	505234	512507	-7870	-7879	1974	1.298	-.291	508871	1.330
87056.9	1052.22	2.49	3.14	51277	499260	506968	-7838	-7608	1828	1.328	-.300	503114	1.304
86056.9	1054.18	2.48	3.05	50752	492625	500769	-7804	-7318	1682	1.359	-.308	496697	1.276
85056.9	1056.26	2.46	2.96	50226	485280	493859	-7768	-7008	1535	1.391	-.317	489570	1.246
84056.9	1058.49	2.45	2.86	49700	477169	486185	-7729	-6678	1389	1.423	-.326	481677	1.214
83056.9	1060.86	2.44	2.76	49174	468232	477684	-7687	-6326	1243	1.455	-.336	472958	1.180
82056.9	1063.37	2.43	2.66	48647	458469	468358	-7643	-5954	1097	1.488	-.345	463414	1.143
81056.9	1066.05	2.42	2.56	48120	447696	458022	-7597	-5557	950	1.521	-.355	452859	1.104
80056.9	1068.08	2.36	2.51	47604	440690	451017	-7487	-5363	843	1.537	-.375	445853	1.078
79056.9	1069.33	2.24	2.52	47101	438594	448436	-7300	-5385	780	1.538	-.405	443515	1.066
78056.9	1070.71	2.13	2.54	46598	436096	445454	-7093	-5408	717	1.538	-.436	440775	1.054
77056.9	1072.20	2.01	2.55	46094	433205	442077	-6868	-5434	654	1.539	-.467	437641	1.040
76056.9	1073.81	1.89	2.56	45590	429920	438306	-6625	-5462	591	1.540	-.499	434113	1.024
75056.9	1075.54	1.77	2.58	45086	426233	434133	-6363	-5491	528	1.541	-.531	430183	1.008
74056.9	1077.39	1.64	2.59	44581	422127	429540	-6083	-5523	465	1.542	-.564	425834	.990
73056.9	1079.37	1.51	2.61	44075	417578	424504	-5784	-5557	402	1.543	-.598	421041	.971
72056.9	1081.47	1.38	2.62	43569	412555	418993	-5465	-5593	339	1.545	-.631	415774	.951
71056.9	1083.72	1.24	2.64	43062	407017	412967	-5126	-5632	276	1.547	-.666	409992	.929
70056.9	1086.11	1.10	2.65	42555	400921	406382	-4765	-5673	213	1.549	-.700	403652	.906
69056.9	1088.64	.96	2.67	42047	394217	399188	-4381	-5716	151	1.551	-.736	396702	.882
68056.9	1091.35	.81	2.69	41538	386849	391329	-3972	-5763	88	1.554	-.771	389089	.856
67056.9	1094.22	.65	2.70	41029	378760	382750	-3537	-5812	26	1.557	-.807	380755	.828
66056.9	1097.26	.49	2.72	40519	369892	373390	-3075	-5864	-36	1.560	-.843	371641	.799
65056.9	1100.50	.33	2.74	40008	360186	363192	-2584	-5919	-98	1.563	-.879	361689	.768
64056.9	1103.94	.16	2.76	39496	349586	352099	-2062	-5978	-161	1.566	-.916	350843	.736
63056.9	1107.58	-.01	2.78	38984	338041	340060	-1509	-6040	-223	1.570	-.953	339051	.702
62056.9	1111.43	-.19	2.80	38471	325506	327030	-924	-6106	-285	1.574	-.990	326268	.666

X(A) COORDINATES

TABLE 3.4-21

CSM-110/LM-8 L.O.I. BURN

WEIGHT LBS.	X-BAR	Y-BAR INCHES	Z-BAR	IXX	IYY	IZZ SLUG-FT SQ	PXY	PXZ	PYZ	PITCH DEGREES	YAW DEGREES	AVERAGE MOMENT	INERTIA/THRUST RATIO
97885.5	1038.48	2.60	4.03	56924	537566	540517	-8091	-9690	3470	1.026	-.225	539041	1.491
96885.5	1039.24	2.59	3.96	56402	535942	539325	-8079	-9579	3324	1.050	-.230	537633	1.482
95885.5	1040.09	2.58	3.88	55879	534030	537847	-8064	-9455	3179	1.075	-.236	535938	1.471
94885.5	1041.04	2.57	3.81	55356	531804	536054	-8048	-9316	3033	1.101	-.241	533929	1.459
93885.5	1042.08	2.56	3.73	54833	529234	533916	-8030	-9162	2887	1.127	-.247	531575	1.445
92885.5	1043.23	2.55	3.65	54309	526287	531403	-8011	-8993	2741	1.154	-.254	528845	1.430
91885.5	1044.49	2.54	3.57	53786	522930	528480	-7989	-8808	2595	1.182	-.260	525705	1.413
90885.5	1045.85	2.53	3.49	53262	519128	525112	-7966	-8607	2449	1.210	-.267	522120	1.394
89885.5	1047.33	2.52	3.40	52737	516842	521260	-7941	-8389	2303	1.239	-.275	518051	1.374
88885.5	1048.92	2.51	3.32	52213	510031	516884	-7913	-8155	2157	1.268	-.282	513458	1.352
87885.5	1050.62	2.50	3.23	51688	504653	511941	-7884	-7902	2011	1.299	-.290	508297	1.327
86885.5	1052.46	2.49	3.14	51163	498663	506386	-7852	-7631	1865	1.329	-.298	502524	1.301
85885.5	1054.42	2.48	3.05	50637	492011	500170	-7818	-7341	1719	1.360	-.307	496090	1.273
84885.5	1056.52	2.47	2.96	50112	484646	493241	-7782	-7031	1572	1.392	-.316	488943	1.243
83885.5	1058.75	2.46	2.86	49586	476514	485545	-7743	-6700	1426	1.424	-.325	481030	1.211
82885.5	1061.13	2.45	2.76	49059	467554	477022	-7702	-6347	1280	1.456	-.334	472288	1.177
81885.5	1063.65	2.44	2.66	48532	457767	467672	-7659	-5975	1134	1.489	-.344	462720	1.140
80885.5	1066.33	2.42	2.56	48005	446968	457310	-7612	-5577	987	1.522	-.354	452139	1.101
79885.5	1068.37	2.36	2.51	47490	439941	450284	-7503	-5383	880	1.538	-.374	445112	1.075
78885.5	1069.63	2.25	2.52	46987	437833	447691	-7315	-5405	817	1.539	-.404	442762	1.063
77885.5	1071.01	2.14	2.54	46484	435321	444694	-7108	-5428	754	1.539	-.435	440007	1.051
76885.5	1072.51	2.02	2.55	45980	432414	441302	-6882	-5454	691	1.540	-.466	436858	1.037
75885.5	1074.13	1.90	2.56	45476	429112	437514	-6639	-5482	628	1.541	-.498	433313	1.021
74885.5	1075.87	1.78	2.58	44972	425406	433322	-6376	-5512	565	1.542	-.530	429364	1.005
73885.5	1077.73	1.65	2.59	44466	421281	428710	-6096	-5543	502	1.543	-.563	424995	.987
72885.5	1079.72	1.52	2.61	43961	416710	423652	-5796	-5577	439	1.544	-.597	420181	.968
71885.5	1081.83	1.39	2.62	43455	411663	418117	-5477	-5614	376	1.546	-.631	414890	.947
70885.5	1084.09	1.25	2.64	42948	406101	412066	-5137	-5652	313	1.548	-.665	409084	.926
69885.5	1086.48	1.11	2.65	42441	399978	405454	-4775	-5693	250	1.550	-.700	402716	.903
68885.5	1089.04	.96	2.67	41933	393244	398230	-4391	-5737	188	1.552	-.735	395737	.878
67885.5	1091.75	.81	2.69	41424	385844	390340	-3981	-5783	125	1.555	-.770	388092	.852
66885.5	1094.63	.66	2.70	40915	377721	381726	-3546	-5833	63	1.558	-.806	379724	.825
65885.5	1097.70	.50	2.72	40405	368816	372330	-3083	-5885	0	1.561	-.842	370573	.796
64885.5	1100.95	.33	2.74	39894	359070	362091	-2591	-5940	-61	1.564	-.879	360580	.765
63885.5	1104.40	.16	2.76	39382	348426	350955	-2068	-5999	-123	1.567	-.915	349690	.732
62885.5	1108.06	-.01	2.78	38870	336834	338868	-1515	-6061	-186	1.571	-.952	337851	.698
61885.5	1111.93	-.19	2.80	38357	324248	325788	-928	-6127	-248	1.575	-.989	325018	.662

X(A) COORDINATES

TABLE 3.4-21 (CONTINUED)

CSM-110/LM-8 L.O.I. BURN

WEIGHT LBS.	X-BAR	Y-BAR INCHES	Z-BAR	IXX	IYY	IZZ SLUG-FT SQ	PXY	PXZ	PYZ	PITCH DEGREES	YAW	AVERAGE MOMENT	INERTIA /THRUST RATIO
60885.5	1116.03	-.38	2.82	37843	310584	311628	-313	-6198	-310	1.579	-1.026	311106	.625
59885.5	1120.37	-.57	2.84	37327	295773	296321	347	-6271	-372	1.583	-1.064	296047	.585
58885.5	1124.96	-.77	2.86	36811	279728	279778	1042	-6349	-433	1.588	-1.101	279753	.544
57885.5	1129.85	-.97	2.89	36294	262168	261720	1783	-6433	-495	1.593	-1.138	261944	.501

X(A) COORDINATES

TABLE 3.4-22

CSM-110/LMB O.O.I. BURN

WEIGHT LBS.	X-BAR	Y-BAR INCHES	Z-BAR	IXX	IYY	IZZ SLUG-FT SQ	PXY	PXZ	PYZ	PITCH DEGREES	YAW DEGREES	AVERAGE MOMENT	INERTIA/THRUST RATIO
97846.1	1038.50	2.60	4.03	56889	537371	540326	-8092	-9694	3479	1.026	-.225	538848	1.490
96846.1	1039.26	2.59	3.96	56366	535745	539134	-8079	-9583	3333	1.050	-.230	537439	1.481
95846.1	1040.11	2.58	3.88	55844	533833	537654	-8065	-9458	3188	1.075	-.235	535744	1.470
94846.1	1041.06	2.57	3.81	55321	531606	535861	-8049	-9319	3042	1.101	-.241	533734	1.458
93846.1	1042.11	2.56	3.73	54798	529035	533722	-8031	-9165	2896	1.127	-.247	531379	1.444
92846.1	1043.26	2.55	3.65	54274	526087	531208	-8012	-8996	2750	1.154	-.253	528648	1.429
91846.1	1044.51	2.55	3.57	53750	522729	528284	-7990	-8811	2604	1.182	-.260	525507	1.412
90846.1	1045.88	2.54	3.49	53226	518925	524914	-7967	-8610	2458	1.210	-.267	521920	1.393
89846.1	1047.35	2.53	3.41	52702	514638	521061	-7942	-8393	2312	1.239	-.274	517849	1.373
88846.1	1048.94	2.52	3.32	52178	509825	516684	-7914	-8158	2166	1.269	-.282	513254	1.351
87846.1	1050.65	2.51	3.23	51653	504446	511739	-7885	-7905	2020	1.299	-.290	508092	1.327
86846.1	1052.49	2.49	3.14	51128	498453	506181	-7853	-7634	1874	1.329	-.298	502317	1.301
85846.1	1054.45	2.48	3.05	50602	491799	499963	-7819	-7344	1728	1.360	-.307	495881	1.273
84846.1	1056.55	2.47	2.96	50077	484432	493032	-7783	-7034	1581	1.392	-.316	488732	1.242
83846.1	1058.78	2.46	2.86	49550	476298	485334	-7745	-6703	1435	1.424	-.325	480816	1.210
82846.1	1061.16	2.45	2.76	49024	467335	476807	-7703	-6350	1289	1.456	-.334	472071	1.176
81846.1	1063.68	2.44	2.66	48497	457545	467454	-7660	-5978	1143	1.489	-.344	462499	1.139
80846.1	1066.37	2.43	2.56	47970	446742	457088	-7613	-5580	996	1.522	-.354	451915	1.100
79846.1	1068.41	2.37	2.51	47454	439712	450059	-7504	-5386	889	1.539	-.374	444886	1.074
78846.1	1069.67	2.25	2.52	46952	437602	447465	-7316	-5407	826	1.539	-.404	442533	1.063
77846.1	1071.06	2.14	2.54	46449	435088	444466	-7109	-5431	763	1.539	-.435	439777	1.050
76846.1	1072.56	2.02	2.55	45945	432179	441071	-6884	-5457	700	1.540	-.466	436625	1.036
75846.1	1074.18	1.90	2.56	45441	428874	437281	-6640	-5485	637	1.541	-.498	433078	1.020
74846.1	1075.92	1.78	2.58	44936	425166	433087	-6378	-5514	574	1.542	-.530	429127	1.004
73846.1	1077.78	1.65	2.59	44431	421038	428472	-6097	-5546	511	1.543	-.563	424755	.986
72846.1	1079.77	1.52	2.61	43926	416464	423411	-5798	-5580	448	1.545	-.596	419938	.967
71846.1	1081.88	1.39	2.62	43420	411414	417873	-5478	-5616	385	1.546	-.630	414644	.947
70846.1	1084.14	1.25	2.64	42913	405848	411818	-5138	-5655	322	1.548	-.665	408833	.925
69846.1	1086.54	1.11	2.65	42406	399721	405202	-4776	-5696	259	1.550	-.699	402461	.902
68846.1	1089.09	.96	2.67	41898	392982	397974	-4391	-5740	197	1.553	-.735	395478	.878
67846.1	1091.81	.81	2.69	41389	385578	390079	-3982	-5786	134	1.555	-.770	387828	.852
66846.1	1094.70	.66	2.70	40880	377449	381460	-3546	-5835	72	1.558	-.806	379455	.824
65846.1	1097.76	.50	2.72	40370	368539	372058	-3083	-5888	9	1.561	-.842	370298	.795
64846.1	1101.02	.33	2.74	39859	358786	361813	-2591	-5943	-52	1.564	-.879	360300	.764
63846.1	1104.47	.16	2.76	39347	348136	350670	-2069	-6002	-114	1.568	-.915	349403	.731
62846.1	1108.13	-.01	2.78	38835	336536	338576	-1515	-6064	-177	1.571	-.952	337556	.697
61846.1	1112.01	-.19	2.80	38322	323943	325487	-928	-6130	-239	1.575	-.989	324715	.661

X(A) COORDINATES

TABLE 3.4-22 (CONTINUED) CSM-110/LM8 D.O.I. BURN

WEIGHT LBS.	X-BAR	Y-BAR INCHES	Z-BAR	IXX	IYY	IZZ SLUG-FT SQ	PXY	PXZ	PYZ	PITCH DEGREES	YAW	AVERAGE MOMENT	INERTIA/THRUST RATIO
60846.1	1116.11	-.38	2.82	37808	310270	311319	-312	-6201	-301	1.579	-1.026	310794	.624
59846.1	1120.46	-.57	2.84	37292	295449	296002	347	-6274	-363	1.583	-1.064	295725	.585
58846.1	1125.05	-.77	2.86	36776	279394	279449	1043	-6352	-424	1.588	-1.101	279421	.544
57846.1	1129.94	-.97	2.89	36259	261822	261379	1784	-6436	-486	1.593	-1.138	261600	.501

X(A) COORDINATES

TABLE 3.4-23

CSM-110 CIRCULARIZATION BURN

WEIGHT LBS.	X-BAR	Y-BAR INCHES	Z-BAR	IXX	IYY	IZZ SLUG-FT SQ	PXY	PXZ	PYZ	PITCH DEGREES	YAW	AVERAGE MOMENT	INERTIA/THRUST. RATIO
63480.8	933.61	3.92	6.48	33782	75654	78232	-1897	-27	3188	-1.542	1.283	76943	.435
62480.8	933.10	3.92	6.41	33266	74991	77995	-1894	-60	3044	-1.519	1.299	76493	.435
61480.8	932.70	3.93	6.33	32749	74409	77840	-1892	-86	2900	-1.490	1.313	76124	.434
60480.8	932.41	3.94	6.25	32233	73889	77747	-1890	-105	2756	-1.456	1.324	75818	.434
59480.8	932.24	3.95	6.17	31716	73413	77697	-1889	-117	2611	-1.416	1.333	75555	.433
58480.8	932.19	3.96	6.09	31199	72958	77670	-1889	-121	2468	-1.370	1.340	75314	.432
57480.8	932.26	3.97	6.00	30682	72503	77643	-1890	-117	2324	-1.318	1.344	75073	.430
56480.8	932.47	3.98	5.91	30165	72025	77592	-1892	-105	2180	-1.259	1.344	74809	.428
55480.8	932.81	3.99	5.82	29647	71498	77493	-1894	-84	2036	-1.195	1.342	74495	.425
54480.8	933.31	4.00	5.73	29130	70895	77318	-1898	-54	1892	-1.124	1.337	74106	.420
53480.8	933.95	4.01	5.63	28612	70187	77038	-1902	-14	1748	-1.047	1.329	73612	.415
52480.8	934.77	4.02	5.52	28093	69343	76623	-1908	36	1604	-.963	1.317	72983	.408
51480.8	935.75	4.03	5.42	27575	68329	76038	-1915	97	1460	-.874	1.302	72183	.400
50480.8	936.93	4.04	5.31	27056	67109	75247	-1923	170	1316	-.778	1.283	71178	.390
49480.8	938.30	4.06	5.19	26537	65644	74211	-1932	256	1173	-.677	1.261	69928	.378
48480.8	939.88	4.07	5.07	26018	63886	72883	-1943	355	1029	-.571	1.235	68385	.364
47480.8	941.67	4.08	4.94	25499	61811	71238	-1955	467	885	-.460	1.206	66525	.348
46480.8	943.72	4.10	4.81	24979	59325	69181	-1969	595	741	-.344	1.174	64253	.330
45480.8	944.61	4.03	4.78	24468	57751	67609	-2006	671	637	-.308	1.120	62680	.319
44480.8	944.06	3.87	4.86	23969	57664	67045	-2047	689	577	-.358	1.048	62354	.319
43480.8	943.64	3.70	4.93	23470	57606	66510	-2078	702	518	-.407	.969	62058	.319
42480.8	943.36	3.52	5.01	22565	57572	65999	-2099	710	458	-.455	.883	61785	.318
41480.8	943.21	3.34	5.10	22468	57558	65506	-2111	715	399	-.503	.790	61532	.318
40480.8	943.19	3.15	5.19	21966	57554	65024	-2114	716	340	-.549	.690	61289	.316
39480.8	943.31	2.95	5.28	21463	57552	64543	-2107	712	281	-.594	.582	61047	.315
38480.8	943.57	2.73	5.38	20960	57538	64050	-2089	703	223	-.638	.468	60794	.313
37480.8	944.00	2.51	5.48	20455	57498	63529	-2060	689	165	-.680	.347	60514	.310
36480.8	944.60	2.27	5.59	19949	57413	62964	-2020	670	107	-.721	.218	60188	.307
35480.8	945.40	2.02	5.70	19443	57263	62331	-1966	644	50	-.759	.082	59797	.303
34480.8	946.40	1.76	5.82	18935	57022	61608	-1897	612	-5	-.794	-.061	59315	.298
33480.8	947.64	1.48	5.95	18425	56663	60767	-1812	572	-62	-.827	-.211	58715	.291
32480.8	949.14	1.18	6.09	17915	56156	59775	-1708	524	-117	-.855	-.368	57966	.284
31480.8	950.93	.86	6.23	17402	55467	58600	-1584	466	-172	-.880	-.531	57034	.275
30480.8	953.04	.52	6.39	16888	54558	57205	-1437	399	-227	-.900	-.699	55882	.265
29480.8	955.51	.16	6.55	16372	53392	55551	-1265	320	-280	-.916	-.873	54472	.253
28480.8	958.36	-.22	6.73	15854	51927	53597	-1066	229	-333	-.927	-1.051	52762	.239
27480.8	961.63	-.64	6.92	15333	50122	51301	-838	124	-385	-.933	-1.233	50712	.224

X(A) COORDINATES

TABLE 3.4-23 (CONTINUED) CSM-110 CIRCULARIZATION BURN

WEIGHT LBS.	X-BAR	Y-BAR INCHES	Z-BAR	IXX	IYY	IZZ SLUG-FT SQ	PXY	PXZ	PYZ	PITCH DEGREES	YAW	AVERAGE MOMENT	INERTIA/THRUST RATIO
26480.8	965.38	-1.08	7.12	14810	47914	48601	-581	3	-436	-.934	-1.418	48257	.207
25480.8	969.66	-1.56	7.34	14284	45232	45425	-278	-132	-486	-.929	-1.605	45328	.189
24480.8	974.54	-2.08	7.58	13754	42001	41697	63	-289	-534	-.919	-1.793	41849	.168
23480.8	980.19	-2.64	7.84	13221	38062	37260	458	-469	-581	-.902	-1.980	37661	.145

X(A) COORDINATES

TABLE 3.4-24

CSM-110 PLANE CHANGE 1

WEIGHT LBS.	X-BAR	Y-BAR INCHES	Z-BAR	IXX	IYY	IZZ SLUG-FT SQ	PXY	PXZ	PYZ	PITCH DEGREES	YAW	AVERAGE MOMENT	INERTIA /THRUST RATIO
63377.5	933.60	3.93	6.48	33685	75575	78166	-1899	-26	3213	-1.541	1.290	76871	.435
62377.5	933.09	3.93	6.40	33173	74911	77929	-1896	-59	3069	-1.518	1.306	76420	.434
61377.5	932.69	3.94	6.33	32656	74329	77773	-1894	-85	2925	-1.489	1.320	76051	.434
60377.5	932.40	3.95	6.25	32140	73810	77681	-1892	-104	2781	-1.455	1.331	75745	.434
59377.5	932.23	3.96	6.17	31623	73333	77631	-1891	-116	2637	-1.415	1.341	75482	.433
58377.5	932.18	3.97	6.09	31106	72878	77604	-1891	-120	2493	-1.368	1.347	75241	.432
57377.5	932.25	3.98	6.00	30589	72424	77576	-1892	-117	2349	-1.316	1.351	75000	.430
56377.5	932.46	3.99	5.91	30072	71945	77526	-1894	-104	2205	-1.258	1.352	74736	.428
55377.5	932.80	4.00	5.82	29554	71418	77426	-1896	-83	2061	-1.193	1.350	74422	.424
54377.5	933.30	4.01	5.72	29036	70815	77251	-1900	-53	1917	-1.122	1.345	74033	.420
53377.5	933.94	4.02	5.62	28518	70107	76972	-1905	-13	1773	-1.044	1.337	73540	.414
52377.5	934.76	4.03	5.52	28000	69264	76557	-1910	36	1629	-.961	1.325	72910	.408
51377.5	935.75	4.05	5.41	27482	68250	75972	-1917	98	1486	-.871	1.310	72111	.399
50377.5	936.92	4.06	5.30	26963	67031	75181	-1925	171	1342	-.775	1.291	71106	.389
49377.5	938.29	4.07	5.18	26444	65566	74145	-1935	257	1198	-.674	1.269	69856	.377
48377.5	939.88	4.09	5.06	25925	63808	72817	-1946	357	1054	-.568	1.243	68312	.364
47377.5	941.68	4.10	4.94	25405	61733	71172	-1959	468	911	-.456	1.214	66452	.348
46377.5	943.73	4.11	4.81	24885	59246	69115	-1973	596	767	-.340	1.182	64181	.330
45377.5	944.62	4.04	4.78	24375	57671	67542	-2009	673	663	-.304	1.128	62607	.319
44377.5	944.07	3.88	4.85	23876	57585	66979	-2051	690	603	-.354	1.056	62282	.319
43377.5	943.65	3.72	4.93	23376	57527	66444	-2082	703	543	-.403	.977	61985	.319
42377.5	943.37	3.54	5.01	22876	57493	65933	-2103	712	484	-.451	.891	61713	.318
41377.5	943.22	3.36	5.09	22375	57479	65441	-2115	716	424	-.499	.798	61460	.317
40377.5	943.20	3.16	5.18	21873	57475	64959	-2117	717	365	-.545	.698	61217	.316
39377.5	943.32	2.96	5.27	21370	57473	64477	-2110	713	307	-.590	.590	60975	.314
38377.5	943.59	2.75	5.37	20867	57459	63984	-2093	704	248	-.634	.476	60722	.312
37377.5	944.02	2.52	5.47	20362	57419	63464	-2064	690	190	-.677	.354	60441	.310
36377.5	944.62	2.29	5.58	19857	57334	62898	-2023	671	133	-.717	.225	60116	.306
35377.5	945.41	2.04	5.69	19350	57183	62266	-1969	645	75	-.755	.089	59724	.302
34377.5	946.42	1.77	5.82	18842	56942	61542	-1901	613	19	-.790	-.054	59242	.297
33377.5	947.67	1.49	5.94	18333	56583	60700	-1815	573	-36	-.823	-.204	58642	.291
32377.5	949.18	1.19	6.08	17822	56076	59708	-1712	525	-92	-.851	-.361	57892	.283
31377.5	950.97	.87	6.23	17310	55385	58533	-1588	468	-147	-.876	-.525	56959	.275
30377.5	953.09	.54	6.38	16756	54476	57136	-1441	400	-201	-.897	-.694	55806	.264
29377.5	955.56	.18	6.55	16280	53307	55481	-1269	321	-255	-.912	-.868	54394	.252
28377.5	958.43	-.21	6.72	15762	51840	53524	-1071	230	-308	-.923	-1.047	52682	.239
27377.5	961.71	-.63	6.91	15241	50032	51225	-.842	125	-360	-.929	-1.229	50629	.224

X(A) COORDINATES

TABLE 3.4-24 (CONTINUED)

CSM-110 PLANE CHANGE 1

WEIGHT LBS.	X-BAR	Y-BAR INCHES	Z-BAR	IXX	IYY	IZZ SLUG-FT SQ	PXY	PXZ	PYZ	PITCH DEGREES	YAW	AVERAGE MOMENT	INERTIA/THRUST RATIO
26377.5	965.48	-1.07	7.12	14718	47820	48521	-585	5	-411	-.930	-1.415	48170	.207
25377.5	969.79	-1.55	7.34	14192	45132	45339	-282	-131	-461	-.925	-1.602	45236	.188
24377.5	974.69	-2.08	7.58	13662	41894	41605	59	-287	-509	-.915	-1.790	41749	.168
23377.5	980.37	-2.64	7.84	13129	37946	37158	454	-468	-556	-.898	-1.978	37552	.145

XA COORDINATES

TABLE 3.4-25

CSM-110 T.E.I. BURN

WEIGHT LBS.	X-BAR	Y-BAR INCHES	Z-BAR	IXX	IYY	IZZ SLUG-FT SQ	PXY	PXZ	PYZ	PITCH DEGREES	YAW	AVERAGE MOMENT	INERTIA/THRUST RATIO
63610.1	934.10	4.05	6.34	33594	75626	78201	-1774	-187	3256	-1.443	1.346	76913	.433
62610.1	933.61	4.06	6.26	33077	74969	77970	-1770	-220	3112	-1.419	1.363	76470	.432
61610.1	933.22	4.07	6.18	32561	74392	77820	-1767	-247	2968	-1.388	1.378	76106	.432
60610.1	932.94	4.08	6.10	32044	73876	77732	-1765	-266	2824	-1.352	1.391	75804	.432
59610.1	932.78	4.09	6.02	31527	73402	77684	-1764	-278	2680	-1.311	1.401	75543	.431
58610.1	932.73	4.10	5.94	31009	72947	77658	-1764	-281	2536	-1.263	1.409	75303	.430
57610.1	932.82	4.11	5.85	30492	72491	77629	-1765	-277	2392	-1.210	1.414	75060	.428
56610.1	933.03	4.12	5.76	29974	72010	77576	-1767	-264	2249	-1.150	1.416	74793	.425
55610.1	933.39	4.14	5.66	29456	71477	77471	-1770	-241	2105	-1.084	1.415	74474	.422
54610.1	933.89	4.15	5.56	28938	70867	77290	-1775	-210	1961	-1.012	1.410	74078	.418
53610.1	934.54	4.16	5.46	28420	70150	77001	-1780	-168	1818	-.934	1.403	73575	.412
52610.1	935.37	4.18	5.36	27901	69294	76574	-1788	-115	1674	-.851	1.392	72934	.405
51610.1	936.36	4.19	5.25	27382	68267	75976	-1796	-51	1530	-.761	1.377	72121	.397
50610.1	937.54	4.21	5.13	26863	67031	75169	-1806	25	1387	-.665	1.360	71100	.387
49610.1	938.92	4.22	5.01	26344	65547	74115	-1818	114	1243	-.564	1.338	69831	.375
48610.1	940.51	4.24	4.89	25824	63767	72765	-1832	217	1100	-.458	1.313	68266	.361
47610.1	942.31	4.26	4.76	25304	61668	71096	-1848	333	956	-.347	1.285	66382	.345
46610.1	944.37	4.28	4.62	24783	59154	69013	-1865	466	813	-.232	1.253	64083	.327
45610.1	945.27	4.21	4.59	24273	57568	67429	-1903	544	709	-.195	1.201	62498	.317
44610.1	944.74	4.05	4.66	23775	57488	66872	-1942	560	648	-.242	1.132	62180	.317
43610.1	944.34	3.89	4.73	23276	57436	66343	-1972	571	588	-.287	1.055	61889	.316
42610.1	944.07	3.72	4.81	22777	57406	65837	-1991	579	528	-.332	.972	61621	.316
41610.1	943.94	3.54	4.88	22276	57394	65346	-2002	583	468	-.376	.882	61370	.315
40610.1	943.94	3.36	4.97	21775	57391	64865	-2003	583	409	-.418	.786	61128	.313
39610.1	944.08	3.16	5.05	21274	57387	64383	-1995	579	350	-.460	.682	60885	.312
38610.1	944.36	2.95	5.15	20771	57370	63887	-1976	570	291	-.500	.571	60628	.310
37610.1	944.81	2.73	5.24	20268	57324	63362	-1947	556	232	-.539	.453	60343	.307
36610.1	945.43	2.50	5.34	19764	57232	62789	-1906	537	174	-.576	.328	60010	.304
35610.1	946.24	2.26	5.45	19258	57071	62147	-1852	512	116	-.611	.196	59609	.299
34610.1	947.27	2.00	5.56	18752	56818	61412	-1783	481	59	-.643	.057	59115	.294
33610.1	948.53	1.73	5.68	18244	56444	60555	-1698	443	2	-.672	-.089	58499	.288
32610.1	950.06	1.44	5.81	17735	55918	59545	-1596	397	-54	-.697	-.242	57732	.281
31610.1	951.87	1.14	5.95	17224	55206	58349	-1473	342	-110	-.719	-.401	56777	.272
30610.1	954.00	.81	6.09	16712	54271	56928	-1328	278	-165	-.737	-.566	55600	.261
29610.1	956.48	.46	6.25	16197	53074	55244	-1159	203	-219	-.751	-.736	54159	.249
28610.1	959.35	.09	6.41	15681	51575	53256	-963	116	-273	-.760	-.910	52415	.236
27610.1	962.65	-.31	6.59	15163	49730	50922	-738	16	-326	-.764	-1.089	50326	.221

XA COORDINATES

TABLE 3.4-25 (CONTINUED)

CSM-110 T.E.I. BURN

Amendment 92
12/4/70

WEIGHT LBS.	X-BAR	Y-BAR INCHES	Z-BAR	IXX	IYY	IZZ SLUG-FT SQ	PXY	PXZ	PYZ	PITCH DEGREES	YAW	AVERAGE MOMENT	INERTIA/THRUST RATIO
26610.1	966.42	-.74	6.78	14642	47478	48178	-486	-97	-378	-.763	-1.270	47828	.204
25610.1	970.72	-1.21	6.98	14119	44746	44953	-189	-227	-430	-.758	-1.453	44850	.185
24610.1	975.62	-1.71	7.21	13592	41460	41171	146	-374	-480	-.747	-1.638	41316	.165
23610.1	981.28	-2.25	7.45	13062	37459	36673	533	-545	-528	-.729	-1.822	37066	.142

XE COORDINATES

TABLE 3.4-26

LM-8 PRE P.D.I. TO TOUCHDOWN

WEIGHT LBS.	X-BAR	Y-BAR INCHES	Z-BAR	IXX	IYY	IZZ SLUG-FT SQ	PXY	PXZ	PYZ	PILOT ROLL DEGREES	PILOT PITCH DEGREES
34072.8	185.88	-.28	.77	23895	26044	25971	187	742	382	-.499	-1.382
33811.6	186.04	-.28	.77	23730	25932	25896	187	741	382	-.500	-1.385
33550.4	186.20	-.28	.78	23566	25818	25819	188	740	383	-.502	-1.389
33289.2	186.36	-.28	.79	23402	25702	25741	188	739	383	-.503	-1.393
33028.0	186.52	-.29	.79	23238	25586	25662	188	738	383	-.504	-1.397
32766.8	186.68	-.29	.80	23073	25468	25581	189	737	383	-.506	-1.402
32505.6	186.83	-.29	.81	22909	25349	25500	189	736	383	-.508	-1.406
32244.4	186.99	-.29	.81	22745	25229	25417	189	736	383	-.509	-1.411
31983.2	187.15	-.30	.82	22581	25108	25334	190	735	383	-.511	-1.416
31722.0	187.31	-.30	.83	22416	24986	25249	190	734	383	-.513	-1.420
31460.8	187.47	-.30	.83	22252	24864	25164	190	733	383	-.515	-1.425
31199.6	187.63	-.30	.84	22088	24740	25078	191	732	383	-.516	-1.430
30938.4	187.80	-.31	.85	21924	24616	24991	191	731	383	-.518	-1.435
30677.2	187.96	-.31	.85	21759	24491	24904	191	730	383	-.520	-1.441
30416.0	188.13	-.31	.86	21595	24366	24815	192	729	383	-.522	-1.446
30154.8	188.31	-.31	.87	21431	24239	24726	192	728	383	-.524	-1.451
29893.6	188.48	-.32	.88	21267	24112	24636	192	727	384	-.526	-1.456
29632.4	188.66	-.32	.88	21102	23984	24545	193	726	384	-.528	-1.461
29371.2	188.85	-.32	.89	20938	23855	24454	193	725	384	-.529	-1.466
29110.0	189.04	-.32	.90	20774	23725	24361	194	724	384	-.531	-1.471
28848.8	189.23	-.33	.91	20610	23594	24268	194	723	384	-.533	-1.477
28587.6	189.44	-.33	.92	20445	23462	24173	194	722	384	-.535	-1.482
28326.4	189.64	-.33	.92	20281	23329	24078	195	721	384	-.537	-1.486
28065.2	189.86	-.34	.93	20117	23195	23981	195	719	384	-.538	-1.491
27804.0	190.08	-.34	.94	19953	23060	23882	196	718	384	-.540	-1.496
27542.8	190.31	-.34	.95	19788	22923	23783	196	717	384	-.542	-1.501
27281.6	190.55	-.35	.96	19624	22784	23682	197	715	384	-.543	-1.505
27020.4	190.80	-.35	.97	19460	22644	23579	197	714	384	-.545	-1.509
26759.2	191.06	-.35	.98	19295	22502	23474	198	713	384	-.546	-1.514
26498.0	191.32	-.36	.99	19131	22359	23368	198	711	384	-.548	-1.518
26236.8	191.60	-.36	1.00	18967	22213	23260	199	710	385	-.549	-1.521
25975.6	191.89	-.36	1.01	18803	22065	23150	199	708	385	-.551	-1.525
25714.4	192.19	-.37	1.02	18638	21915	23037	200	706	385	-.552	-1.528
25453.2	192.50	-.37	1.03	18474	21763	22922	201	704	385	-.553	-1.532
25192.0	192.82	-.38	1.04	18310	21604	22800	201	703	385	-.554	-1.535
24930.8	193.15	-.38	1.05	18146	21441	22675	202	701	385	-.555	-1.538
24669.6	193.50	-.38	1.06	17981	21277	22548	203	699	385	-.556	-1.540

XE COORDINATES

TABLE 3.4-26 (CONTINUED)

LM-8 PRE P.O.I. TO TOUCHDOWN

WEIGHT LBS.	X-BAR	Y-BAR INCHES	Z-BAR	IXX	IYY	IZZ SLUG-FT SQ	PXY	PXZ	PYZ	PILOT ROLL DEGREES	PILOT PITCH DEGREES
24408.4	193.86	-.39	1.07	17817	21110	22418	203	697	385	-.557	-1.543
24147.2	194.24	-.39	1.09	17653	20939	22284	204	695	385	-.558	-1.545
23886.0	194.62	-.40	1.10	17488	20763	22146	205	692	385	-.558	-1.547
23624.8	195.03	-.40	1.11	17324	20584	22004	206	690	385	-.559	-1.548
23363.6	195.45	-.40	1.12	17160	20400	21858	207	688	385	-.560	-1.550
23102.4	195.88	-.41	1.13	16995	20212	21707	208	685	385	-.560	-1.551
22841.2	196.33	-.41	1.15	16831	20019	21552	208	683	386	-.560	-1.552
22580.0	196.80	-.42	1.16	16667	19822	21392	209	680	386	-.561	-1.553
22318.8	197.28	-.42	1.17	16503	19621	21228	210	677	386	-.561	-1.554
22057.6	197.78	-.43	1.19	16338	19414	21059	211	675	386	-.561	-1.554
21796.4	198.30	-.43	1.20	16174	19202	20885	212	672	386	-.561	-1.554
21535.2	198.83	-.44	1.22	16010	18986	20706	214	669	386	-.561	-1.554
21274.0	199.37	-.44	1.23	15845	18765	20522	215	665	386	-.561	-1.554
21012.8	199.96	-.45	1.25	15681	18538	20332	216	662	386	-.561	-1.554
20751.6	200.55	-.46	1.26	15517	18307	20138	217	659	386	-.561	-1.554
20490.4	201.16	-.46	1.28	15352	18070	19939	218	655	386	-.561	-1.553
20229.2	201.80	-.47	1.30	15188	17828	19734	220	652	386	-.560	-1.552
19968.0	202.45	-.47	1.31	15024	17581	19524	221	648	387	-.560	-1.551
19706.8	203.12	-.48	1.33	14860	17328	19309	222	644	387	-.560	-1.550
19445.6	203.78	-.49	1.35	14695	17084	19103	224	641	387	-.560	-1.550
19184.4	204.50	-.49	1.37	14531	16821	18877	225	637	387	-.559	-1.549
18923.2	205.23	-.50	1.38	14367	16553	18646	227	632	387	-.559	-1.548
18662.0	205.99	-.51	1.40	14202	16281	18411	228	628	387	-.558	-1.547
18400.8	206.77	-.51	1.42	14038	16004	18172	230	624	387	-.558	-1.546
18139.6	207.57	-.52	1.44	13874	15722	17927	231	619	387	-.558	-1.545
17878.4	208.39	-.53	1.47	13709	15434	17677	233	615	387	-.557	-1.543
17617.2	209.24	-.54	1.49	13545	15142	17422	235	610	387	-.557	-1.542
17356.0	210.11	-.54	1.51	13380	14844	17162	237	605	387	-.556	-1.541
17094.8	211.01	-.55	1.53	13216	14540	16895	238	600	388	-.556	-1.540
16833.6	211.94	-.56	1.56	13052	14229	16622	240	595	388	-.556	-1.539
16572.4	212.89	-.57	1.58	12887	13913	16343	242	589	388	-.555	-1.538
16311.2	213.88	-.58	1.61	12723	13589	16057	244	584	388	-.555	-1.537
16050.0	214.90	-.59	1.63	12559	13259	15764	246	578	388	-.554	-1.535
15788.8	215.96	-.60	1.66	12394	12921	15463	249	572	388	-.554	-1.534

XE COORDINATES TABLE 3.4-27 LM-8 AS LUNAR LIFTOFF TO INSERTION

WEIGHT LBS.	X-BAR	Y-BAR INCHES	Z-BAR	IXX	IYY	IZZ SLUG-FT SQ.	PXY	PXZ	PYZ	ROLL MOMENT OFFSET (DEG./SEC. SQ.)	PITCH MOMENT
10838.5	244.16	.04	2.86	6787	3450	5951	59	223	-18	.101	5.682
10578.5	244.55	.04	2.93	6609	3434	5758	59	221	-18	.109	5.420
10318.5	244.97	.04	3.00	6430	3418	5564	59	218	-18	.119	5.142
10058.5	245.41	.04	3.08	6251	3401	5370	59	215	-18	.129	4.846
9798.5	245.87	.04	3.16	6073	3383	5174	59	212	-18	.141	4.532
9538.5	246.36	.05	3.25	5894	3364	4978	59	209	-18	.154	4.197
9278.5	246.87	.05	3.34	5715	3344	4780	59	205	-18	.169	3.839
9018.5	247.42	.05	3.43	5537	3323	4581	59	202	-18	.185	3.455
8758.5	247.99	.05	3.54	5358	3300	4381	58	198	-18	.204	3.044
8498.5	248.61	.06	3.64	5179	3277	4180	58	194	-18	.225	2.601
8238.5	249.26	.06	3.76	5000	3251	3977	58	187	-18	.249	2.123
7978.5	249.95	.06	3.88	4821	3224	3773	58	185	-18	.276	1.606
7718.5	250.69	.07	4.01	4642	3195	3567	58	180	-18	.308	1.044
7458.5	251.48	.07	4.15	4463	3165	3359	58	174	-18	.345	.432
7198.5	252.33	.07	4.30	4284	3131	3149	58	169	-18	.389	-.238
6938.5	253.24	.08	4.46	4105	3096	2936	58	163	-18	.441	-.974
6678.5	254.22	.08	4.64	3925	3058	2721	57	156	-18	.503	-1.787
6418.5	255.28	.09	4.83	3746	3016	2503	57	149	-18	.579	-2.688
6158.5	256.44	.09	5.03	3567	2971	2281	57	141	-18	.674	-3.695
5898.5	257.69	.10	5.25	3387	2922	2056	57	133	-18	.795	-4.825

XE COORDINATES

TABLE 3.4-28

LM-8 T.P.I. BURN

WEIGHT LBS.	X-BAR	Y-BAR INCHES	Z-BAR	I XX	I YY	I ZZ SLUG-FT SQ.	PXY	PXZ	PYZ	ROLL MOMENT OFFSET (DEG./SEC. SQ.)	PITCH MOMENT
6134.1	256.14	.10	4.99	3569	2964	2282	57	144	-16	.734	-3.544
6108.1	256.26	.10	5.01	3551	2960	2260	57	144	-16	.745	-3.651
6082.1	256.38	.10	5.04	3533	2955	2237	57	143	-16	.757	-3.759
6056.1	256.50	.10	5.06	3515	2950	2215	57	142	-16	.769	-3.868
6030.1	256.63	.10	5.08	3497	2946	2193	57	141	-16	.782	-3.979
6004.1	256.75	.10	5.10	3479	2941	2170	57	140	-16	.795	-4.091
5978.1	256.87	.10	5.12	3461	2936	2148	57	140	-16	.808	-4.204
5952.1	257.00	.11	5.15	3443	2931	2125	57	139	-16	.821	-4.318
5926.1	257.13	.11	5.17	3425	2926	2103	57	138	-16	.835	-4.434
5900.1	257.26	.11	5.19	3407	2922	2080	57	137	-16	.849	-4.552
5874.1	257.39	.11	5.21	3389	2917	2057	56	136	-16	.864	-4.670
5848.1	257.52	.11	5.24	3371	2912	2035	56	135	-16	.878	-4.791
5822.1	257.65	.11	5.26	3353	2906	2012	56	134	-16	.894	-4.912
5796.1	257.78	.11	5.28	3335	2901	1989	56	134	-16	.909	-5.035
5770.1	257.92	.11	5.31	3317	2896	1966	56	133	-16	.926	-5.160
5744.1	258.05	.11	5.33	3299	2891	1944	56	132	-16	.942	-5.287

SUPPLEMENTARY DATA APPLICABLE TO SEQUENTIAL MASS PROPERTIES TABLES

General Comments to be applied to Tables 3.5-1 through 3.5-8:

Inertia data dispersions are +10%.

Dispersions shall be used as 3σ deviation values.

All initial propellant weights are total tanked.

The (+) or (-) sign following the name of an item indicates that the item is added to or subtracted from the preceding total.

Table 3.5-1

SM/SPS gimbal angles for SPS abort sequence are: Pitch = -0.4104
Yaw = 1.895

Tables 3.5-7 and 3.5-8

CSM and LM consumables changes are presented in Tables 3.5-7 and 3.5-8, respectively.

Table 3.5-3

The mass Spectrometer and Gamma-Ray Spectrometer are shown deployed after each SPS firing following D.O.I. For all other summations the M.S. and G.R. Spectrometers are not deployed. The following are the individual mass properties for the M.S. and G.R. Spectrometers in Apollo Coordinates.

	Weight (lb)	X-Bar (in)	Y-Bar (in)	Z-Bar (in)
Gamma-Ray Retracted	45.4	865.1	33.0	-57.0
Gamma-Ray Deployed	{28.0 17.4	865.1 865.1	231.3 132.2	-312.4 -184.7
Mass Spectrometer Retracted	47.4	863.1	55.8	-40.5
Mass Spectrometer Deployed	{27.4 20.0	863.1 863.1	341.7 198.8	-149.4 -94.9

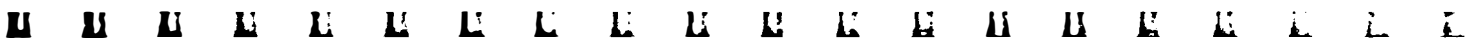

U
N
I
T
E
D
S
T
A
T
E
S
O
F
A
M
E
R
I
C
A

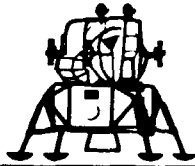

Amendment 94
12/10/70

XE COORDINATES TABLE 3.5-1
LM-10 EXPECTED SEQUENTIAL MASS PROPERTIES

DESCRIPTION	S	WEIGHT POUNDS	C. G. INCHES			INERTIAS SLUG-FT ²			PRODUCTS SLUG-FT ²			DISPERSIONS LB/IN			
			X	Y	Z	I _{XX}	I _{YY}	I _{ZZ}	P _{XY}	P _{XZ}	P _{YZ}	D _W	D _X	D _Y	D _Z
ASCENT STAGE	+	4726.0	257.6	-.2	3.0	2777	2676	1581	57	116	-9	25.0	1.0	.5	.5
34 LM RCS FUEL	+	102.5	279.1	44.6	14.5	0	0	0	0	0	0	1.0	1.0	.1	.1
37 LM RCS FUEL	+	102.6	279.1	-44.6	-14.5	0	0	0	0	0	0	1.0	1.0	.1	.1
28 LM RCS OXY	+	200.7	275.4	-44.6	14.5	0	1	1	0	0	0	2.0	1.0	.1	.1
31 LM RCS OXY	+	200.7	275.4	44.6	-14.5	0	1	1	0	0	0	2.0	1.0	.1	.1
22 LM APS FUEL	+	2002.7	228.0	-71.3	.0	0	0	0	0	0	0	5.4	1.0	.5	.5
19 LM APS OXY	+	3217.5	228.0	44.5	.0	0	0	0	0	0	0	8.7	1.0	.5	.5
ASCENT STAGE		10552.7	244.1	-.1	1.3	6642	3329	6035	52	157	-36	27.2	.6	.3	.3
DESCENT STAGE	+	6179.0	156.4	3.4	-7.4	6983	4874	3796	144	-89	264	25.0	1.0	.5	.5
77 LM DPS FUEL	+	3755.5	160.4	54.0	.0	0	7	7	0	0	0	7.1	1.0	.5	.5
80 LM DPS FUEL	+	3755.5	160.4	-54.0	.0	0	7	7	0	0	0	7.1	1.0	.5	.5
71 LM DPS OXY	+	5998.7	160.4	.0	54.0	0	12	12	0	0	0	12.7	1.0	.5	.5
74 LM DPS OXY	+	5998.8	160.4	.0	-54.0	0	12	12	0	0	0	12.7	1.0	.5	.5
DESCENT STAGE		25687.5	159.4	.8	-1.8	19328	12537	8592	130	-58	238	32.4	.5	.2	.2
LM AT EARTH LAUNCH		36240.2	184.1	.6	-.9	25988	27440	26186	64	525	197	42.3	.4	.2	.2

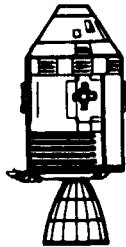

Amendment 94
12/10/70

XA COORDINATES TABLE 3.5-2
CSM 112/LM10 EXPECTED SEQUENTIAL MASS PROPERTIES

DESCRIPTION	S	WEIGHT POUNDS	C. G. INCHES			INERTIAS SLUG-FT ²			PRODUCTS SLUG-FT ²			DISPERSIONS LB/IN.			
			X	Y	Z	I _{XX}	I _{YY}	I _{ZZ}	P _{XY}	P _{XZ}	P _{YZ}	DM	DX	DY	DZ
SLA RING	+	98.0	835.7	2.0	-6.6	120	65	56	0	0	0	.0	.0	.0	.0
SERVICE MODULE	+	13475.0	917.3	1.6	.5	9464	14323	13186	-173	530	-1616	25.0	1.0	.5	.5
COMMAND MODULE	+	12863.0	1041.3	-.2	5.5	5886	5405	4959	29	-409	14	25.0	1.0	.5	.5
CSM LESS SPS PROPELLANT		26436.0	977.3	.7	2.9	15512	42096	40472	-464	1030	-1615	35.4	.7	.4	.4
43 SM SPS F-STORE	+	6756.7	904.0	-14.8	-47.8	0	1915	1915	0	0	0	59.0	1.0	.5	.5
46 SM SPS D-STORE	+	10768.9	903.9	14.8	47.8	0	3047	3047	0	0	0	121.0	1.0	.5	.5
49 SM SPS F-SUMP	+	8868.7	906.8	-48.3	-6.6	0	2608	2608	0	0	0	59.0	1.0	.5	.5
52 SM SPS D-SUMP	+	14199.4	907.0	48.3	6.6	0	4210	4210	0	0	0	121.0	1.0	.5	.5
SM WITH SPS PROPELLANT		54166.7	908.4	6.3	4.3	30223	35242	37446	-245	356	2334	192.0	.5	.3	.3
CSM AT EARTH LAUNCH		67029.7	933.9	5.0	4.5	36206	80267	82115	-2140	304	2331	193.6	.4	.2	.2

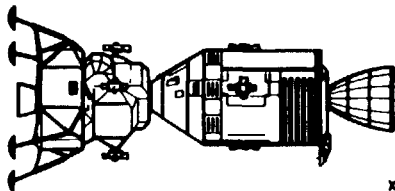

Amendment 94
12/10/70

XA COORDINATES TABLE 3.5-2 (CONTINUED)
CSM 112/LM10 EXPECTED SEQUENTIAL MASS PROPERTIES

DESCRIPTION	S	WEIGHT POUNDS	C. G. INCHES			INERTIAS SLUG-FT ²			PRODUCTS SLUG-FT ²			DISPERSIONS LB/IN			
			X	Y	Z	IXX	IYY	IZZ	PXY	PXZ	PYZ	DW	DX	DY	DZ
CSM AT EARTH LAUNCH		67029.7	933.9	5.0	4.5	36206	80267	82115	-2140	304	2331	193.6	.4	.2	.2
LM AT EARTH LAUNCH		36240.2	583.6	.6	-.9	25988	27440	26186	64	525	197	42.3	.4	.2	.2
SLA (EXCLUDING RING)		3985.4	637.6	1.1	.5	10147	12629	12606	-47	117	28	25.0	1.0	.5	.5
LES		9190.0	1300.9	.0	-.9	817	28433	28414	16	460	1	25.0	1.0	.5	.5
CSM+LM+SLA+LES AT LAUNCH		116445.3	843.7	3.1	2.3	73458	1247123	1247626	3092	8189	2705	201.3	.3	.2	.2
CSM+LM+SLA AT E.O.I.		107255.3	804.5	3.4	2.6	72598	768523	769047	6127	10863	2683	199.8	.4	.2	.2
CSM+LM+SLA PRE TRANS/DOCK		107243.5	804.5	3.4	2.6	72596	768498	769027	6118	10857	2685	199.8	.4	.2	.2
CSM AT TRANS/DOCK.		66947.3	933.9	5.0	4.5	36129	80221	82083	-2146	305	2353	193.6	.4	.2	.2
LM AT TRANS/DOCK.		36237.5	1238.2	-.5	.9	25983	26220	27193	-488	211	-445	42.3	.4	.3	.1
CSM/LM DOCKED		103184.8	1040.8	3.1	3.3	62332	576387	579309	11114	-5066	2008	198.2	.4	.2	.2
CM EQUIP.RELOC.1	-	507.9	1042.6	-8.7	-11.5	35	7	31	0	1	2	.0	.0	.0	.0
CM EQUIP.RELOC.1	+	507.9	1035.4	-8.9	-13.2	29	26	36	-7	6	-2	.0	.0	.0	.0
SIM DOOR	-	160.0	912.1	43.2	-59.5	20	65	85	0	0	0	.0	.0	.0	.0
CM GASEOUS O2	+	6.7	1168.7	13.0	-7.5	0	0	0	0	0	0	.0	.0	.0	.0
CSM/LM PRE L.O.I.		102816.5	1041.2	3.0	3.4	61982	574878	577841	10998	-5275	2139	198.2	.4	.2	.2
CSM/LM POST L.O.I.		76132.2	1084.2	2.0	1.8	48150	442009	448208	-8533	-594	-999	198.2	.7	.2	.2

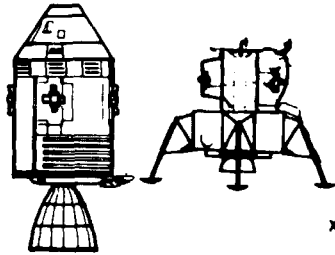

Amendment 94
12/10/70

XA COORDINATES TABLE 3.5-2 (CONTINUED)
CSM 112/LM10 EXPECTED SEQUENTIAL MASS PROPERTIES

DESCRIPTION	S	WEIGHT POUNDS	C. G. INCHES			INERTIAS SLUG-FT ²			PRODUCTS SLUG-FT ²			DISPERSIONS LB/IN			
			X	Y	Z	I _{XX}	I _{YY}	I _{ZZ}	P _{XY}	P _{XZ}	P _{YZ}	D _W	D _X	D _Y	D _Z
CSM/LM PRE D.O.I.		76079.3	1084.3	2.0	1.8	48100	441724	447930	-8539	-592	-986	198.2	.7	.2	.2
CSM/LM POST D.O.I.		75505.5	1085.5	1.9	1.8	47810	438350	444276	-8351	-598	-1023	198.2	.7	.2	.2
DEPLOY M.S. AND G.R.		75505.5	1085.5	2.1	1.7	49853	439200	445468	-9210	42	-1894	198.2	.7	.2	.2
2 CREW+EQUIP,CM-LM	-	488.4	1042.5	13.9	-10.9	21	4	22	-2	1	-1	.0	.0	.0	.0
EQUIP.XFR,LM-CM 1	+	1.1	1018.0	24.5	-15.0	0	0	0	0	0	0	.0	.0	.0	.0
CM EQUIP.RELOC.2	-	180.4	1021.5	-1.8	-20.1	15	13	11	-1	1	-2	.0	.0	.0	.0
CM EQUIP.RELOC.2	+	180.4	1041.8	-.3	-13.8	20	5	16	0	1	2	.0	.0	.0	.0
LANDING GEAR UP	-	488.0	1306.5	1.1	-.7	740	444	451	-2	1	-6	.0	.0	.0	.0
LANDING GEAR DOWN	+	488.0	1303.1	1.6	-.9	1921	1027	1139	-3	2	-10	.0	.0	.0	.0
2 CREW+EQUIP,CM-LM	+	488.4	1163.3	39.3	-21.3	55	43	17	1	2	23	.0	.0	.0	.0
LM EQUIP.RELOC.1	-	11.0	1156.5	47.7	-22.3	0	0	0	0	0	0	.0	.0	.0	.0
LM EQUIP.RELOC.1	+	11.0	1150.6	15.8	-21.9	0	0	0	0	0	0	.0	.0	.0	.0
EQUIP.XFR,LM-CM 1	-	1.1	1122.7	.0	-.0	0	0	0	0	0	0	.0	.0	.0	.0
CSM/LM AT SEPARATION		75342.3	1086.5	2.1	1.8	49047	438255	444259	-8016	-864	-1046	198.2	.7	.2	.2

Gamma-Ray and mass spectrometers are not deployed unless specifically stated. See page 3.5-1.

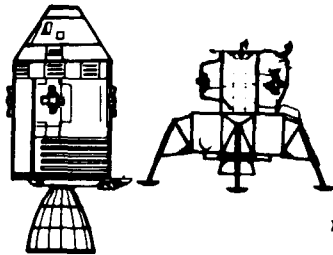

Amendment 94
12/10/70

XA COORDINATES TABLE 3.5-2(CONTINUED)
CSM 112/LM10 EXPECTED SEQUENTIAL MASS PROPERTIES

DESCRIPTION	S	WEIGHT POUNDS	C. G. INCHES			INERTIAS SLUG-FT ²			PRODUCTS SLUG-FT ²			DISPERSIONS LB/IN			
			X	Y	Z	I _{XX}	I _{YY}	I _{ZZ}	P _{XY}	P _{XZ}	P _{YZ}	DX	DY	DZ	
CSM PRE CIRC. BURN		38612.9	943.5	4.0	2.9	21526	60373	65287	-2501	1449	-554	193.6	.7	.3	.3
CSM POST CIRC. BURN		38316.3	943.7	4.0	2.9	21379	60336	65109	-2489	1447	-572	193.6	.7	.3	.3
EXPERIMENT JETT SM	-	77.3	886.0	22.0	-50.3	0	0	0	0	0	0	.0	.0	.0	.0
CSM AT SATT. JETT.		38239.0	943.8	3.9	3.0	21326	60234	65048	-2471	1395	-556	193.6	.7	.3	.3
DEPLOY M.S. AND G.R.		38239.0	943.8	4.4	2.6	23358	61090	66223	-2781	1625	-1425	193.6	.7	.3	.3
CSM PRE PLANE CHANGE 1		37940.0	943.9	4.0	3.0	21086	60053	64908	-2489	1414	-486	193.6	.7	.3	.3
CSM POST PLANE CHANGE 1		36703.2	944.9	3.7	3.0	20471	59820	64082	-2427	1402	-564	193.6	.7	.3	.3
DEPLOY M.S. AND G.R.		36703.2	944.9	4.2	2.6	22504	60676	65259	-2741	1635	-1434	193.6	.7	.3	.3
CSM AT ASCT. STAGE DOCKING		36618.0	945.0	3.8	3.0	20386	59757	64032	-2425	1402	-541	193.6	.7	.3	.3
ASCENT STAGE AT DOCKING		5775.0	1164.1	4.5	-2.8	3299	2249	2658	-157	33	-387	27.2	.8	.6	.2
CSM/ASCENT STAGE MANNED		42393.0	974.8	3.9	2.2	23723	113756	118406	-2407	59	-933	195.5	.8	.3	.3

Gamma-Ray and mass spectrometers are not deployed unless specifically stated. See page 3.5-1.

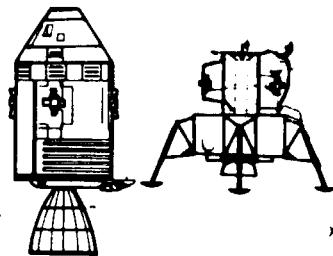

Amendment 94
12/10/70

XA COORDINATES
CSM 112/LM10 EXPECTED SEQUENTIAL MASS PROPERTIES

TABLE 3.5-2 (CONTINUED)

DESCRIPTION	S	WEIGHT POUNDS	C. G. INCHES			INERTIAS SLUG-FT ²			PRODUCTS SLUG-FT ²			DISPERSIONS LB/IN			
			X	Y	Z	IXX	IYY	IZZ	PXY	PXZ	PYZ	DX	DY	DZ	
2 CREW+EQUIP, LM-CM	-	830.2	1164.2	22.9	-19.0	160	73	123	11	1	9	.0	.0	.0	.0
EQUIP.XFR. CM-LM	+	376.5	1150.6	.0	-.0	0	62	62	0	0	0	.0	.0	.0	.0
LM EQUIP.RELOC.3	-	21.4	1122.7	.0	-.0	0	0	0	0	0	0	.0	.0	.0	.0
LM EQUIP.RELOC.3	+	21.4	1204.2	31.4	-40.8	0	0	0	0	0	0	.0	.0	.0	.0
2 CREW+EQUIP, LM-CM	+	830.2	1033.0	9.7	1.4	105	96	73	7	-18	-17	.0	.0	.0	.0
EQUIP.XFR. CM-LM	-	376.5	1066.7	3.9	11.6	27	187	174	-16	-38	0	.0	.0	.0	.0
CSM/ASCENT STAGE UNMANNED		42380.9	973.0	3.6	2.5	23503	109632	114243	-3007	648	-893	195.5	.7	.3	.3
CSM POST ASCENT STAGE JET		37071.7	945.7	3.9	2.9	20465	59842	64118	-2310	1311	-561	193.6	.7	.3	.3

Gamma-Ray and mass spectrometers are not deployed unless specifically stated. See page 3.5-1.

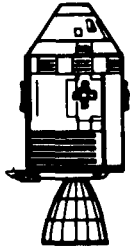

Amendment 94
12/10/70

KA COORDINATES TABLE 3.5-2(CONTINUED)
CSM 112/LM10 EXPECTED SEQUENTIAL MASS PROPERTIES

DESCRIPTION	S	WEIGHT POUNDS	C. G. INCHES			INERTIAS SLUG-FT ²			PRODUCTS SLUG-FT ²			DISPERSIONS LB/IN			
			X	Y	Z	I _{XX}	I _{YY}	I _{ZZ}	P _{XY}	P _{XZ}	P _{YZ}	OX	OX	OY	OZ
DEPLOY M.S. AND G.R.		37071.7	945.7	4.4	2.5	22496	60698	65294	-2627	1547	-1429	193.6	.7	.3	.3
CM EQUIP.RELOC.3	-	190.2	1040.5	-1.1	-12.8	22	7	18	1	0	1	.0	.0	.0	.0
CM EQUIP.RELOC.3	+	190.2	1022.3	6.6	-23.0	30	24	16	-2	4	-10	.0	.0	.0	.0
CSM PRE T.E.I.		36829.5	945.7	4.0	2.8	20299	59598	63872	-2400	1311	-522	193.6	.7	.3	.3
CSM POST T.E.I.		27288.4	968.6	1.5	3.2	15518	47213	46886	-987	1080	-1118	193.6	1.1	.4	.4
DEPLOY M.S. AND G.R.		27288.4	968.6	2.1	2.8	17569	48071	48079	-1393	1382	-1994	193.6	1.1	.4	.4
EQUIP.XFR. SM-CM	-	89.1	930.1	39.3	-53.4	1	13	14	-4	0	0	.0	.0	.0	.0
EQUIP.XFR. SM-CM	+	89.1	1020.4	-24.0	16.0	3	9	5	0	4	0	.0	.0	.0	.0
EVA OFFLOAD	-	32.6	1047.8	-26.8	37.3	0	0	0	0	0	0	.0	.0	.0	.0
CSM AT E.V.A		27255.8	968.8	1.3	3.4	15433	47120	46834	-965	1035	-1076	193.6	1.1	.4	.4
DEPLOY M.S. AND G.R.		27255.8	968.8	2.0	2.9	17486	47979	48029	-1372	1338	-1954	193.6	1.1	.4	.4
CM EQUIP.RELOC.4	-	26.2	1027.0	-10.1	-4.8	5	4	3	0	0	0	.0	.0	.0	.0
CM EQUIP.RELOC.4	+	26.2	1037.0	-2.2	-15.9	3	3	4	1	1	1	.0	.0	.0	.0
CSM PRE CM/SM SEPARATION		27006.5	969.2	1.4	3.3	15272	46911	46666	-988	1066	-1019	193.6	1.1	.4	.4
SM POST CM/SM SEPARATION		14060.7	904.6	2.8	1.0	9258	15112	15391	-439	554	-989	192.0	1.3	.7	.7

3.5-8

SNA-B-D-027 (III) REV 2

Gamma-Ray and mass spectrometers are not deployed unless specifically stated. See page 3.5-1.

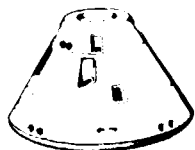

Amendment 94
12/10/70

XA COORDINATES TABLE 3.5-2(CONTINUED)
CSM 112/LM10 EXPECTED SEQUENTIAL MASS PROPERTIES

DESCRIPTION	S	WEIGHT POUNDS	C. G. INCHES			INERTIAS SLUG-FT ²			PRODUCTS SLUG-FT ²			DISPERSIONS LB/IN			
			X	Y	Z	IXX	IYY	IZZ	PXY	PXZ	PYZ	DM	DX	DY	DZ
CM POST CM/SM SEPARATION		12945.8	1039.4	-.2	5.8	5970	5326	4320	38	-384	-10	25.0	1.0	.5	.5
CM AT ENTRY		12934.2	1039.4	-.1	5.8	5963	5319	4819	38	-382	-9	25.0	1.0	.5	.5
ABLATOR BURNOFF	-	150.0	1031.1	.0	7.4	103	81	78	0	0	0	.0	.0	.0	.0
ENTRY COOLING	-	2.0	1022.6	-19.7	62.5	0	0	0	0	0	0	.0	.0	.0	.0
FWD HEAT SHIELD	-	310.0	1094.3	-.5	.8	64	26	23	0	0	0	.0	.0	.0	.0
OROGUE+DISCONNECTS	-	80.0	1089.0	.0	23.9	1	1	0	0	0	0	.0	.0	.0	.0
CM AT MAIN CHUTE DEPLOY		12361.5	1037.9	-.1	5.6	5768	4930	4462	38	-373	-6	25.0	1.0	.5	.5
PILOT CHUTE+RISERS	-	45.5	1089.9	5.9	-5.8	2	2	1	0	0	0	.0	.0	.0	.0
MAIN CHUTE	-	401.4	1089.1	.4	8.5	62	22	43	0	0	0	.0	.0	.0	.0
CM HCS DUMP	-	202.7	1022.6	-5.8	57.0	0	0	0	0	0	0	.0	.0	.0	.0
CM AT IMPACT		11711.9	1036.2	-.1	4.7	5581	4515	4145	29	-351	6	25.0	1.1	.5	.5

U
N
I
T
E
D
S
T
A
T
E
S
O
F
A
M
E
R
I
C
A

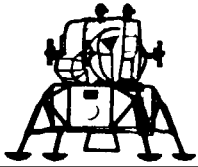

Amendment 94
12/10/70

XE COORDINATES TABLE 3.5-3
LM-10 EXPECTED SEQUENTIAL MASS PROPERTIES

DESCRIPTION	S	WEIGHT POUNDS	C. G. INCHES			INERTIAS SLUG-FT ²			PRODUCTS SLUG-FT ²			DISPERSIONS LB/IN			
			X	Y	Z	IXX	IYY	IZZ	PXY	PXZ	PYZ	DX	DY	DZ	
LM AT EARTH LAUNCH		36240.2	184.1	.6	-0.9	25988	27440	26186	64	525	197	42.3	.4	.2	.2
LANDING GEAR UP	-	488.0	116.3	.0	1.3	740	455	441	0	3	0	.0	.0	.0	.0
LANDING GEAR DOWN	+	488.0	119.7	.0	1.8	1921	1046	1021	0	4	0	.0	.0	.0	.0
LM CABLING	-	2.7	209.7	88.8	-29.0	0	0	0	0	0	0	.0	.0	.0	.0
CM GASEOUS O ₂	+	6.7	254.0	.0	15.0	0	0	0	0	0	0	.0	.0	.0	.0
2 CREW+EQUIP,CM-LM	+	488.4	259.5	1.2	44.7	55	4	56	-3	0	0	.0	.0	.0	.0
LM EQUIP.RELOC.1	-	11.0	266.2	4.5	52.4	0	0	0	0	0	0	.0	.0	.0	.0
LM EQUIP.RELOC.1	+	11.0	272.2	-11.1	24.6	0	0	0	0	0	0	.0	.0	.0	.0
EQUIP.XFR,LM-CM 1	-	1.1	300.0	.0	.0	0	0	0	0	0	0	.0	.0	.0	.0
LM AT SEPARATION		36701.5	185.1	.6	-0.3	27408	28767	27338	64	879	193	42.3	.4	.2	.2
LM PRE P.O.I.		36635.5	185.0	.6	-0.3	27372	28637	27189	66	880	191	42.3	.4	.2	.2

SNA-B-D-027(III) REV 2

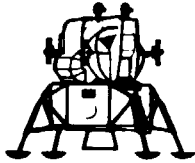

Amendment 94
12/10/70

XE COORDINATES
LM-10 EXPECTED SEQUENTIAL MASS PROPERTIES

DESCRIPTION	S	WEIGHT POUNDS	C. G. INCHES			INERTIAS SLUG-FT ²			PRODUCTS SLUG-FT ²			DISPERSIONS LB/IN			
			X	Y	Z	IXX	IYY	IZZ	PXY	PXZ	PYZ	DW	DX	DY	DZ
ASCENT STAGE AT T.P.I.		5876.0	258.2	-.2	5.2	3342	2870	2026	49	155	-18	27.2	.8	.4	.4
ASCENT STAGE AT DOCKING		5775.0	257.7	-.2	5.3	3299	2848	1973	49	158	-16	27.2	.8	.4	.4
2 CREW+EQUIP, LM-CM	-	830.2	258.5	-5.0	29.4	160	103	93	-7	-8	26	.0	.0	.0	.0
EQUIP.XFR. CM-L4	+	376.5	272.1	.0	.0	0	62	62	0	0	0	.0	.0	.0	.0
LM EQUIP.RELOC.3	-	21.4	300.0	.0	.0	0	0	0	0	0	0	.0	.0	.0	.0
LM EQUIP.RELOC.3	+	21.4	218.5	-19.6	47.6	0	0	0	0	0	0	.0	.0	.0	.0
ASCENT STAGE AT JETTISON		5309.2	258.2	.5	1.4	3022	2707	1948	60	154	-23	27.2	.9	.5	.4

Table 3.5-4

High Altitude Abort Mass Properties

To be Supplied at a Later Date

M U N E L L L E N E L E H H E L L E

Table 3.5-6

SIVB Sequential Mass Properties (LV Coordinates)

To be Supplied at a Later Date

M M E

TABLE 3.5-7

CSM 112 Consumables Weight Change Summary

(To be used in conjunction with CSM sequential mass properties Table 3.5-2)

From	EVENT	To	Consumable	Weight Change (Pounds)	Amount Remaining (Pounds)	Total Usage (Pounds)
Earth Orbit		Pre Trans/Dock	SM-Hydrogen	-0.8	81.6	-0.8
			SM-Oxygen	-15.8	934.0	-15.8
			CM-Potable H ₂ O	+4.0	40.0	
			CM-Waste H ₂ O	+0.8	18.8	
Pre Trans/Dock		Post Trans/Dock	SM-RCS	-70.6	1271.8	-70.6
Post Trans/Dock		Pre L.O.I.	SM-Hydrogen	-15.5	66.1	-16.3
			SM-Oxygen	-155.6	778.4	-171.4
			SM-RCS	-85.5	1186.3	-156.1
			CM-Waste H ₂ O	+41.2	60.0	
			CM-L1OH	+13.6	13.6	
			CM-Food	-13.2		-13.2
Pre L.O.I.		Post L.O.I.	SM-SPS	-26684.3	13909.4	-26684.3
Post L.O.I.		Pre D.O.I.	SM-Hydrogen	-0.8	65.3	-17.1
			SM-Oxygen	-7.4	771.0	-178.8
			SM-RCS	-44.7	1141.6	-200.8
Pre D.O.I.		Post D.O.I.	SM-SPS	-573.8	13335.6	-27258.1
Post D.O.I.		CSM/LM Separation	SM-Hydrogen	-3.4	61.9	-20.5
			SM-Oxygen	-35.9	735.1	-214.7
			SM-RCS	-95.1	1046.5	-295.9
			CM-L1OH	5.0	18.6	
			CM-Food	-3.8		-17.0
CSM/LM Separation		Pre Circularization	SM-Hydrogen	-0.3	61.6	-20.8
			SM-Oxygen	-2.6	732.5	-217.3
			SM-RCS	-25.0	1021.5	-320.9
Pre Circularization		Post Circularization	SM-SPS	-296.6	13039.0	-27554.7



TABLE 3.5-7 (Continued)

CSM 112 Consumables Weight Change Summary

(To be used in conjunction with CSM sequential mass properties Table 3.5-2)

From	EVENT	To	Consumable	Weight Change (Pounds)	Amount Remaining (Pounds)	Total Usage (Pounds)
Post Circularization		Pre Plane Change 1	SM-Hydrogen	-13.2	48.4	-34.0
			SM-Oxygen	-117.4	615.1	-334.7
			SM-RCS	-168.4	853.1	-489.3
Pre Plane Change 1		Post Plane Change 1	SM-SPS	-1236.8	11802.2	-28791.5
Post Plane Change 1		CSM/ASCT Docking	SM-Hydrogen	-1.7	46.7	-35.7
			SM-Oxygen	-14.2	600.9	-348.7
			SM-RCS	-73.0	780.1	-562.3
			CM-Food	-6.3		-23.3
			CM-LiOH	+7.8	26.4	
			CM-Fecal	+2.2	2.2	
CSM/ASCT Docking		Pre T.E.I.	SM-Hydrogen	-10.9	35.8	-46.6
			SM-Oxygen	-104.7	496.2	-453.6
			SM-RCS	-128.9	651.2	-691.2
			CM-LiOH	+5.0	31.4	
			CM-Fecal	+1.1	3.3	
			CM-Food	-3.8		-27.1
Pre T.E.I.		Post T.E.I.	SM-SPS	-9541.1	2661.1	-38332.6
Post T.E.I.		SM Jettison	SM-Hydrogen	-14.9	20.9	-61.5
			SM-Oxygen	-168.9	327.3	-622.5
			SM-RCS	-71.8	579.4	-763.0
			CM-LiOH	+13.4	44.8	
			CM-Food	-10.4		-37.5
			CM-Fecal	+3.3	6.6	
SM Jettison		CM @ Entry	CM-RCS	-11.6	233.4	-11.6
CM @ Entry		CM @ M.C. Deploy	CM-RCS	-30.7	202.7	-42.3
CM @ M.C. Deploy		CM @ Impact	CM-RCS	-202.7	0.0	-245.0



TABLE 3.5-8

Amendment 94
12/10/70

LM-10 Consumables Change Summary

(To be used in conjunction with the LM sequential mass properties Table 3.5-2)

From	EVENT	To	Consumable	Weight Change (Pounds)	Amount Remaining (Pounds)	Total Usage (Pounds)
Earth Orbit		CSM/LM Separation	D/S-Oxygen	-5.0	91.0	-5.0
			D/S-Water	-20.0	360.0	-20.0
			LM-RCS	-5.0	601.5	-5.0
CSM/LM Separation		Pre P.D.I.	D/S-Oxygen	-3.0	88.0	-8.0
			D/S-Water	-12.0	348.0	-32.0
			LM-RCS	-51.0	550.5	-56.0
Pre P.D.I.		LM @ Touchdown	D/S-Oxygen	-1.0	87.0	-9.0
			D/S-Water	-3.0	345.0	-35.0
			LM-RCS	-100.0	450.5	-156.0
			LM-DPS	-18762.0	746.5	-18762.0
LM @ Touchdown	A/S @ Lift-Off	LM-RCS	-5.0	445.5	-161.0	
LM @ Lift-Off	A/S in Orbit	LM-APS	-4958.7	261.5	-4958.7	
A/S in Orbit		A/S @ T.P.I.	A/S-Water	-8.0	77.0	-8.0
			A/S-Oxygen	-0.4	4.4	-0.4
			LM-RCS	-20.0	425.5	-181.0
A/S @ T.P.I.		A/S @ Docking	A/S Water	-20.0	57.0	-28.0
			A/S-Oxygen	-1.0	3.4	-1.4
			LM-RCS	-80.0	345.5	-261.0
A/S @ Docking	A/S Jettison	A/S-Water	-12.0	45.0	-40.0	

MISSION J-1 TRANSFERABLE EQUIPMENT

REFERENCE CODE EXPLANATION

The reference table used with this Transferable Equipment List is a directory of information sources from which data for each item were obtained. It is intended to define the exact source for each portion of the data used. This reference table is correlated to each item in the Transferable Equipment List by a 3-digit reference code number.

The code is the form

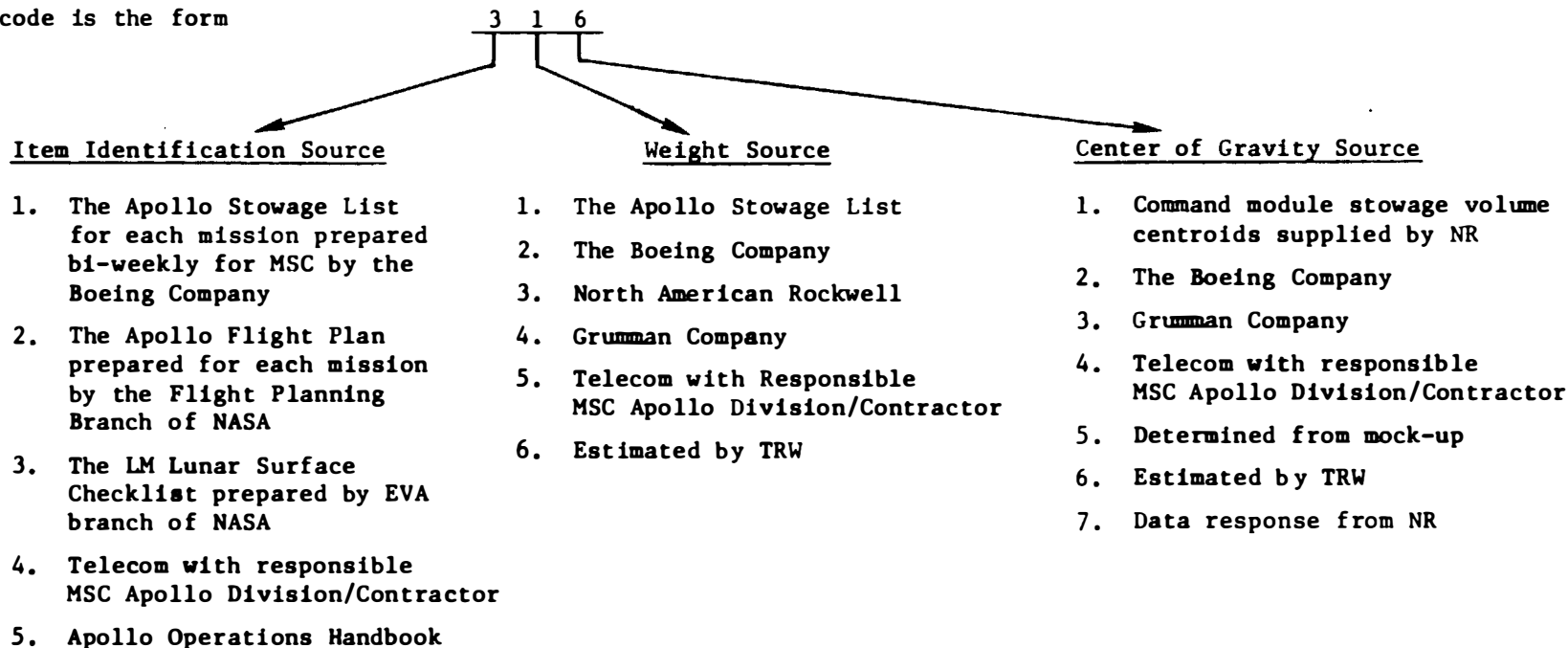

TABLE 3.5-9

MISSION J-1 COMMAND MODULE STOWAGE VOLUME CENTROIDS

S/C 112

<u>AREA</u>	<u>X</u>	<u>Y</u>	<u>Z</u>
A1	1012.0	-22.0	-26.0
2	1010.0	-23.0	8.0
3	1016.0	-24.0	28.0
4	1015.0	-7.0	28.0
5	1015.0	9.0	28.0
6	1017.0	26.0	28.0
7	1010.0	23.0	8.0
8	1012.0	22.0	-23.0
9	1013.0	0.0	16.0
B1	1050.0	-27.0	39.0
2	1039.0	-38.0	37.0
3	1031.0	-28.0	40.0
4	1031.0	-20.0	40.0
5	1031.0	-8.0	39.0
6	1031.0	13.0	39.0
8	1024.0	-38.0	37.0
L2	1059.0	-44.0	14.0
3	1048.0	-47.0	12.0
R1	1072.0	26.0	21.0
2	1072.0	26.0	14.0
3	1072.0	26.0	9.0
4	1075.0	28.0	3.0
5	1059.0	44.0	15.0
6	1048.0	46.0	29.0
8	1052.0	46.0	12.0
11	1038.0	47.0	26.0
13	1024.0	45.0	-26.0
U1	1033.0	23.0	-50.0
2	1033.0	-23.0	-50.0
3	1033.0	-36.0	-44.0
4	1038.0	39.0	-43.0



Table 3.5-9.1

The following stowage locations have unique volume centroids not associated with stowage volumes.

<u>NOMENCLATURE</u>	<u>LOCATION</u>	<u>X</u>	<u>Y</u>	<u>Z</u>
G&N Signal Cond. Panel	LEB	1069.0	25.0	29.0
Display Keyboard	LEB	1060.0	26.0	32.0
Sleep Restraint Assy - Right	Aft UEB	1018.0	25.0	-47.9
Sleep Restraint Assy - Left	Aft UEB	1018.0	-21.0	-49.9
Food Container	L3	1048.0	-47.0	12.0
Food Container	B1	1050.0	-27.0	39.0
Fecal Stowage Container	RHEB	1039.0	47.0	12.0
PGA Container	On Aft Bulkhead Under Center Couch	1015.0	0.0	-19.9
Forward Hatch Container	Under L.H. Couch	1018.0	-24.5	-15.0
Container, R12 (In-flight Location)	R.H. Girth Ring	1036.5	40.0	-25.0
Helmet Stowage and Accessory Bags (In-flight Location) - L.H.	L.H. Girth Ring	1036.5	-40.0	-25.0
Helmet Stowage and Accessory Bags (In-flight Location) - Ctr.	LEB	1050.0	-27.0	39.0
Helmet Stowage and Accessory Bags (In-flight Location) - R.H.	R.H. Girth Ring	1036.5	40.0	-25.0
Temporary Stowage Bag - L.H. (In-flight Location)	LHEB	1039.0	-47.0	12.0
Temporary Stowage Bag - Ctr. (In-flight Location)	LEB	1050.0	-27.0	39.0
Temporary Stowage Bag - R.H. (In-flight Location)	RHEB	1039.0	47.0	12.0
CO ₂ Absorbers (2)	In ECU	1031.0	-48.3	19.6
CO ₂ Absorbers (4)	A3	1016.0	-24.0	28.0
CO ₂ Absorbers (4)	A4	1015.0	- 7.0	28.0
CO ₂ Absorbers (2)	A6	1017.0	26.0	28.0
CO ₂ Absorbers (4)	B5	1031.0	- 8.0	39.0
CO ₂ Absorbers (4)	B6	1031.0	13.0	39.0
	Composite Loca- tion used in Sequential Mass Properties Tables For CO ₂ Absorbed.			
First 6.8 lb. CO ₂ Absorbed	B5	1031.0	- 8.0	39.0
Next 6.8 lb. CO ₂ Absorbed	B6	1031.0	13.0	39.0
Remainder CO ₂ Absorbed	Composite Loca- tion	1018.5	-14.3	26.1



TABLE 3.5-9.2

MISSION J-1 LUNAR MODULE STOWAGE VOLUME CENTROIDS

LM-10

<u>AREA</u>	<u>X</u>	<u>Y</u>	<u>Z</u>
A1B	262.8	-20.8	15.4
A1C ICG Assy	240.5	-15.3	13.3
A1C	240.5	-18.0	13.3
A1D	270.3	-15.0	19.0
A1E	265.9	-20.7	-6.0
A1F	257.4	-20.7	-6.0
A1G	257.5	-20.0	-18.0
A1H	265.9	-20.0	-18.0
A1K	281.0	-20.0	-8.5
A1L	273.7	-20.0	-8.5
A2	260.0	-37.0	28.0
A3	280.0	0	-10.0
A4	244.1	-3.5	13.5
A5	224.3	-1.5	29.3
A10	250.0	8.8	-11.8
A11 PLSS LiOH Cart	263.6	18.8	-2.4
A11 ECS LiOH Cart	261.2	20.7	5.9
A12	272.0	0	-18.0
A13	300.0	0	0
F1A	244.5	-36.6	31.4
F1B	235.5	-35.5	38.5
F1C	242.5	-35.6	38.6
F1D	242.8	-35.4	47.2
F1E	237.9	-33.6	55.0
F1F	235.5	-37.6	46.6
F1G	228.0	-40.2	43.2
F5	286.0	17.8	66.6
F6	270.3	0	52.8
F6B	270.3	0	52.8
F6C	270.3	0	52.8
F7A	238.0	38.0	49.8
F7B	238.0	38.0	49.8
F7C	238.0	38.0	41.0
F7D	238.0	38.0	38.4
F7E	238.0	38.0	32.7
F7F	238.0	38.0	31.6
F7H	238.0	38.0	45.5
F7J	238.0	38.0	39.2
F7K	238.0	38.0	42.7



TABLE 3.5-9.2 (Continued)

MISSION J-1 LUNAR MODULE STOWAGE VOLUME CENTROIDS

LM-10

<u>AREA</u>	<u>X</u>	<u>Y</u>	<u>Z</u>
F7L	236.0	36.0	48.0
F7N	238.0	38.0	53.1
F7P	238.0	38.0	53.4
F8	221.0	18.0	51.0
F9	219.7	0	44.7
F10	221.0	-18.0	51.0

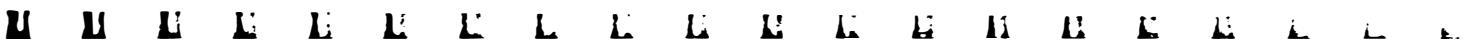

Table 3.5-9.3

MISSION J-1 TRANSFERRED CREW AND EQUIPMENT STOWAGE LIST								
ITEMS REARRANGED IN CM PRIOR TO FIRST MID-COURSE CORRECTION (1)								
APOLLO COORDINATES								
DESCRIPTION	STOW. ITEM	REF	NO.	STOWAGE LOCATION	WEIGHT	X-C.G.	Y-C.G.	Z-C.G.
CREW-COMMAND MODULE PILOT(CMP)	TBD	227	1	ON COUCH(CTR CRW STA	159.0	1043.0	.0	-10.4
CREW-COMMANDER (CDR)	TBD	227	1	ON COUCH(LH CREW STA	167.0	1043.0	-24.5	-10.4
ADAPTER,CWG ELECTRICAL-CMP	80135.	111	1	IN ADAPTER BAG (AB)	.4	1012.0	22.0	-23.0
ADAPTER,CWG ELECTRICAL-CDR	80135.	111	1	IN ADAPTER BAG (AB)	.4	1012.0	22.0	-23.0
ADAPTER,CWG ELECTRICAL-LMP	80135.	111	1	IN ADAPTER BAG (AB)	.4	1012.0	22.0	-23.0
HEADSET, LIGHT WEIGHT	E0104.	111	1	AREA AB	.4	1012.0	22.0	-23.0
HEADSET, LIGHT WEIGHT	E0104.	111	1	AREA AB	.4	1012.0	22.0	-23.0
HEADSET, LIGHT WEIGHT	E0104.	111	1	AREA AB	.4	1012.0	22.0	-23.0
ASSY, BIOINSTRUMENTATION	80203.	111	1	ON CREW-CMP(CTR STA)	1.1	1043.0	.0	-10.4
ASSY, BIOINSTRUMENTATION	80203.	111	1	ON CREW-CDR(LH STA)	1.1	1043.0	-24.5	-10.4
UCTA	80205.	111	1	ON CREW-LMP(RH STA)	.5	1043.0	24.5	-10.4
UCTA	80205.	111	1	ON CREW-CDR(LH STA)	.5	1043.0	-24.5	-10.4
UCTA	80205.	111	1	ON CREW-CMP(CTR STA)	.5	1043.0	.0	-10.4
ITLSA IV	80212.	111	1	ON CREW-CMP(CTR STA)	40.4	1043.0	.0	-10.4
ITLSA EV	80211.	111	1	ON CREW-CDR(LH STA)	45.0	1043.0	-24.5	-10.4
ITLSA EV	80211.	111	1	ON CREW-LMP(RH STA)	45.0	1043.0	24.5	-10.4
GLOVES, IV PAIR	80213.	111	1	ON CREW-CMP(CTR STA)	2.1	1043.0	.0	-10.4
GLOVES, IV PAIR	80213.	111	1	ON CREW-CDR(LH STA)	2.1	1043.0	-24.5	-10.4
GLOVES, IV PAIR	80213.	111	1	ON CREW-LMP(RH STA)	2.1	1043.0	24.5	-10.4
HELMET ASSY, PRESSURE	80214.	111	1	ON CREW-CMP(CTR STA)	2.6	1043.0	.0	-10.4
HELMET ASSY, PRESSURE	80214.	111	1	ON CREW-CDR(LH STA)	2.6	1043.0	-24.5	-10.4
HELMET ASSY, PRESSURE	80214.	111	1	ON CREW-LMP(RH STA)	2.6	1043.0	24.5	-10.4
HARNESS, ELEC.-SUIT	80215.	111	1	ON CREW-CDR(LH STA)	.5	1043.0	-24.5	-10.4
HARNESS, ELEC.-SUIT	80215.	111	1	ON CREW-CMP(CTR STA)	.5	1043.0	.0	-10.4
HARNESS, BIOINSTRUMENTATION	80216.	111	1	ON CREW-CDR(LH STA)	.3	1043.0	-24.5	-10.4
HARNESS, BIOINSTRUMENTATION	80216.	111	1	ON CREW-CMP(CTR STA)	.3	1043.0	.0	-10.4
COMMUNICATION CARRIER	80217.	111	1	ON CREW-LMP(RH STA)	1.6	1043.0	24.5	-10.4
COMMUNICATION CARRIER	80217.	111	1	ON CREW-CDR(LH STA)	1.6	1043.0	-24.5	-10.4
COMMUNICATION CARRIER	80217.	111	1	ON CREW-CMP(CTR STA)	1.6	1043.0	.0	-10.4
POCKET, CHECKLIST + SCISSORS	80218.	111	1	ON CREW-LMP(RH STA)	.2	1043.0	24.5	-10.4
POCKET, CHECKLIST + SCISSORS	80218.	111	1	ON CREW-CDR(LH STA)	.2	1043.0	-24.5	-10.4
POCKET, CHECKLIST + SCISSORS	80218.	111	1	ON CREW-CMP(CTR STA)	.2	1043.0	.0	-10.4

Table 3.5-9.3 (Continued)

MISSION J-1 TRANSFERRED CREW AND EQUIPMENT STOWAGE LIST								
ITEMS REARRANGED IN CM PRIOR TO FIRST MID-COURSE CORRECTION (1)								APOLLO COORDINATES
DESCRIPTION	STOW. ITEM	REF	NO.	STOWAGE LOCATION	WEIGHT	X-C.G.	Y-C.G.	Z-C.G.
POCKET, CHECKLIST	80219.	111	1	ON CREW-LMP(RH STA)	.2	1043.0	24.5	-10.4
POCKET, CHECKLIST	80219.	111	1	ON CREW-CDR(LH STA)	.2	1043.0	-24.5	-10.4
POCKET, CHECKLIST	80219.	111	1	ON CREW-CMP(CTR STA)	.2	1043.0	.0	-10.4
DOSIMETER, PERSONAL	00200.	117	1	ON CREW-CDR(LH STA)	.4	1043.0	-24.5	-10.4
DOSIMETER, PERSONAL	00200.	117	1	ON CREW-CMP(CTR STA)	.4	1043.0	.0	-10.4
DOSIMETER, PASSIVE	00201.	117	3	CMG POCKET(STOWED)	NEGL	1015.0	.0	-19.0
DOSIMETER, PASSIVE	00201.	117	3	CMG POCKET(STOWED)	NEGL	1015.0	.0	-19.0
EARPIECE, MOULDED (COM.CARRIER)	E0200.1	111	1	ON CREW-LMP(RH STA)	NEGL	1043.0	24.5	-10.4
EARPIECE, MOULDER (COM.CARRIER)	E0200.1	111	1	ON CREW-COR(CTR. STA)	NEGL	1043.0	.0	-10.4
EARTUBE (COM.CARRIER)	E0200.2	111	2	ON CREW-LMP(RH STA)	NEGL	1043.0	24.5	-10.4
EARTUBE (COM.CARRIER)	E0200.2	111	2	ON CREW-COR(CTR. STA)	NEGL	1043.0	.0	-10.4
BAG, HELMET STOW, INFLIGHT	80105.	115	1	AREA U2	.6	1033.0	-23.0	-50.2
BAG, HELMET STOW, INFLIGHT	80105.	115	1	AREA U2	.6	1033.0	-23.0	-50.2
BAG, HELMET STOW, INFLIGHT	80105.	115	1	AREA U2	.6	1033.0	-23.0	-50.2
BAG, ACCESSORY	80105.1	115	1	IN HSB (U2)	.3	1033.0	-23.0	-50.2
BAG, ACCESSORY	80105.1	115	1	IN HSB (U2)	.3	1033.0	-23.0	-50.2
BAG, ACCESSORY	80105.1	115	1	IN HSB (U2)	.3	1033.0	-23.0	-50.2
JACKET ASSY, ICG	80112.1	111	1	AREA U2	1.8	1033.0	-23.0	-50.2
JACKET ASSY, ICG	80112.1	111	1	AREA U2	1.8	1033.0	-23.0	-50.2
JACKET ASSY, ICG	80112.1	111	1	AREA U2	1.8	1033.0	-23.0	-50.2
TROUSER ASSY, ICG	80112.2	111	1	AREA U2	1.8	1033.0	-23.0	-50.2
TROUSER ASSY, ICG	80112.2	111	1	AREA U2	1.8	1033.0	-23.0	-50.2
TROUSER ASSY, ICG	80112.2	111	1	AREA U2	1.8	1033.0	-23.0	-50.2
BOOT, RIGHT, ICG	80112.3	111	1	AREA U2	.4	1033.0	-23.0	-50.2
BOOT, RIGHT, ICG	80112.3	111	1	AREA U2	.4	1033.0	-23.0	-50.2
BOOT, RIGHT, ICG	80112.3	111	1	AREA U2	.4	1033.0	-23.0	-50.2
BOOT, LEFT, ICG	80112.4	111	1	AREA U2	.4	1033.0	-23.0	-50.2
BOOT, LEFT, ICG	80112.4	111	1	AREA U2	.4	1033.0	-23.0	-50.2
BOOT, LEFT, ICG	80112.4	111	1	AREA U2	.4	1033.0	-23.0	-50.2
OPS CONTROL UNIT ADAPTER	80151.	111	1	AREA A2	1.4	1010.0	-23.0	8.0
STRAPS, ATTACH, OPS/PGA	80152.	111	2	AREA A2	NEGL	1010.0	-23.0	8.0
STRAPS, ATTACH, OPS/PGA	80153.	111	1	AREA A2	NEGL	1010.0	-23.0	8.0

Table 3.5-9.3 (Continued)

MISSION J-1 TRANSFERRED CREW AND EQUIPMENT STOWAGE LIST								
ITEMS REARRANGED IN CM PRIOR TO FIRST MID-COURSE CORRECTION (1)								
APOLLO COORDINATES								
DESCRIPTION	STOW. ITEM	REF	NO.	STOWAGE LOCATION	WEIGHT	X-C.G.	Y-C.G.	Z-C.G.
PANEL IND.-VERB/NOUN LIST	H0104.	115	1	GNIC PANEL	.2	1050.0	.0	22.0
BAG,MOTION SICKNESS	A0208.	111	1	ON PGA (CREW-CTR STA)	.1	1043.0	.0	-10.4
BAG,MOTION SICKNESS	A0208.	111	1	ON PGA (CREW-LH STA)	.1	1043.0	-24.5	-10.4
BAG,MOTION SICKNESS	A0208.	111	1	ON PGA (CREW-RH STA)	.1	1043.0	24.5	-10.4
POCKET,CHECKLIST + SCISSORS	80201.5	167	1	ON CREW-CMP(CTR STA)	NEGL	1043.0	.0	-10.4
VEST,DUAL LIFE	80202.	111	1	ON CREW-CMP(CTR STA)	2.4	1043.0	.0	-10.4
VEST,DUAL LIFE	80202.	111	1	ON CREW-CDR(LH STA)	NEGL	1043.0	-24.5	-10.4
VEST,DUAL LIFE	80202.	111	1	ON CREW-LMP(RH STA)	NEGL	1043.0	24.5	-10.4
CONTAINER,R12	00344.	115	1	AREA R3	2.7	1072.0	26.0	9.0
EARTUBE,UNIVERSAL	E0105.	111	1	AREA U2	NEGL	1033.0	-23.0	-50.2
EARTUBE,UNIVERSAL	E0105.	111	1	AREA U2	NEGL	1033.0	-23.0	-50.2
EARTUBE,UNIVERSAL	E0105.	111	1	AREA U2	NEGL	1033.0	-23.0	-50.2
EARPIECE,MOULDED (COM.CARRIER)	E0200.1	111	1	ON CREW-CMP(LH STA)	NEGL	1043.0	-24.5	-10.4
EARTUBE (COM.CARRIER)	E0200.2	111	1	ON CREW-CMP(LH STA)	NEGL	1043.0	-24.5	-10.4
CM EQUIP.RELOC.1					507.91	1042.61	-8.71	-11.54

Table 3.5-9.3 (Continued)

MISSION J-1 TRANSFERRED CREW AND EQUIPMENT STOWAGE LIST								
ITEMS REARRANGED IN CM PRIOR TO FIRST MID-COURSE CORRECTION (2)								
APOLLO COORDINATES								
DESCRIPTION	STOW. ITEM	REF	NO.	STOWAGE LOCATION	WEIGHT	X-C.G.	Y-C.G.	Z-C.G.
CREW-COMMAND MODULE PILOTICMP)	T8D	227	1	ON COUCHILH CREW STA	159.0	1043.0	-24.5	-10.4
CREW-COMMANDER (COR)	T8D	227	1	ON COUCHICTR CRW STA	167.0	1043.0	.0	-10.4
ADAPTER,CWG ELECTRICAL-CMP	80135.	111	1	ON CREW-CMPILH STA	.4	1043.0	-24.5	-10.4
ADAPTER,CWG ELECTRICAL-COR	80135.	111	1	ON CREW-COR(CTR.STA)	.4	1043.0	.0	-10.4
ADAPTER,CWG ELECTRICAL-LMP	80135.	111	1	ON CREW-LMP(RH STA)	.4	1043.0	24.5	-10.4
HEADSET, LIGHT WEIGHT	E0104.	111	1	ON CREW-CMP(LH STA)	.4	1043.0	-24.5	-10.4
HEADSET, LIGHT WEIGHT	E0104.	111	1	ON CREW-COR(CTR.STA)	.4	1043.0	.0	-10.4
HEADSET, LIGHT WEIGHT	E0104.	111	1	ON CREW-LMP(RH STA)	.4	1043.0	24.5	-10.4
ASSY, BIOINSTRUMENTATION	80203.	111	1	ON CREW-CMP(LH STA)	1.1	1043.0	-24.5	-10.4
ASSY, BIOINSTRUMENTATION	80203.	111	1	ON CREW-COR(CTR.STA)	1.1	1043.0	.0	-10.4
UCTA	80205.	111	1	IN CM PGA CONTAINER	.5	1015.0	.0	-19.9
UCTA	80205.	111	1	IN CM PGA CONTAINER	.5	1015.0	.0	-19.9
UCTA	80205.	111	1	IN CM PGA CONTAINER	.5	1015.0	.0	-19.9
ITLSA IV	80212.	111	1	IN CM PGA CONTAINER	40.4	1015.0	.0	-19.9
ITLSA EV	80211.	111	1	IN CM PGA CONTAINER	45.0	1015.0	.0	-19.9
ITLSA EV	80211.	111	1	IN CM PGA CONTAINER	45.0	1015.0	.0	-19.9
GLOVES,IV PAIR	80213.	111	1	IN HSB (U2)	2.1	1033.0	-23.0	-50.2
GLOVES,IV PAIR	80213.	111	1	IN HSB (U2)	2.1	1033.0	-23.0	-50.2
GLOVES,IV PAIR	80213.	111	1	IN HSB (U2)	2.1	1033.0	-23.0	-50.2
HELMET ASSY, PRESSURE	80214.	111	1	IN HSB (U2)	2.6	1033.0	-23.0	-50.2
HELMET ASSY, PRESSURE	80214.	111	1	HELMET STOW BAG (B1)	2.6	1050.0	-27.0	39.0
HELMET ASSY, PRESSURE	80214.	111	1	HELMET STOW BAG (L3)	2.6	1048.0	-47.0	12.0
HARNESS, ELEC.-SUIT	80215.	111	1	ON CREW-COR(CTR.STA)	.5	1043.0	.0	-10.4
HARNESS, ELEC.-SUIT	80215.	111	1	ON CREW-CMP(LH STA)	.5	1043.0	-24.5	-10.4
HARNESS, BIOINSTRUMENTATION	80216.	111	1	ON CREW-COR(CTR.STA)	.3	1043.0	.0	-10.4
HARNESS, BIOINSTRUMENTATION	80216.	111	1	ON CREW-CMP(LH STA)	.3	1043.0	-24.5	-10.4
COMMUNICATION CARRIER	80217.	111	1	IN HSB (U2)	1.6	1033.0	-23.0	-50.2
COMMUNICATION CARRIER	80217.	111	1	HELMET STOW BAG (B1)	1.6	1050.0	-27.0	39.0
COMMUNICATION CARRIER	80217.	111	1	HELMET STOW BAG (L3)	1.6	1048.0	-47.0	12.0
POCKET, CHECKLIST + SCISSORS	80218.	111	1	ON ICG-CMP./LH STA.	.2	1043.0	-24.5	-10.4
POCKET, CHECKLIST + SCISSORS	80218.	111	1	ON ICG-COR./CTR.STA.	.2	1043.0	.0	-10.4
POCKET, CHECKLIST + SCISSORS	80218.	111	1	ON ICG-LMP./RH STA.	.2	1043.0	24.5	-10.4

Table 3.5-9.3 (Continued)

MISSION J-1 TRANSFERRED CREW AND EQUIPMENT STOWAGE LIST								
ITEMS REARRANGED IN CM PRIOR TO FIRST MID-COURSE CORRECTION (2)								
APOLLO COORDINATES								
DESCRIPTION	STOW. ITEM	REF	NO.	STOWAGE LOCATION	WEIGHT	X-C.G.	Y-C.G.	Z-C.G.
POCKET, CHECKLIST	80219.	111	1	ON ICG-CMP./LH STA.	.2	1043.0	-24.5	-10.4
POCKET, CHECKLIST	80219.	111	1	ON ICG-CDR./CTR.STA.	.2	1043.0	.0	-10.4
POCKET, CHECKLIST	80219.	111	1	ON ICG-LMP./RH STA.	.2	1043.0	24.5	-10.4
DOSIMETER, PERSONAL	00200.	117	1	ON CREW-CDR(CTR. STA)	.4	1043.0	.0	-10.4
DOSIMETER, PERSONAL	00200.	117	1	ON CREW-CMP(LH STA)	.4	1043.0	-24.5	-10.4
DOSIMETER, PASSIVE	00201.	117	3	CWG POCKET(CREW-CDR)	NEGL	1043.0	.0	-10.4
DOSIMETER, PASSIVE	00201.	117	3	CWG POCKET(CREW-LMP)	NEGL	1043.0	24.5	-10.4
EARPIECE, MOULDED (COM.CARRIER)	E0200.1	111	1	IN HSB (U2)	NEGL	1033.0	-23.0	-50.2
EARPIECE, MOULDER (COM.CARRIER)	E0200.1	111	1	IN HSB (U2)	NEGL	1033.0	-23.0	-50.2
EARTUBE (COM.CARRIER)	E0200.2	111	2	IN HSB (U2)	NEGL	1033.0	-23.0	-50.2
EARTUBE (COM.CARRIER)	E0200.2	111	2	HELMET STOW BAG (B1)	NEGL	1050.0	-27.0	39.0
BAG, HELMET STOW, INFLIGHT	80105.	115	1	AREA U2	.6	1033.0	-23.0	-50.2
BAG, HELMET STOW, INFLIGHT	80105.	115	1	AREA B1	.6	1050.0	-27.0	39.0
BAG, HELMET STOW, INFLIGHT	80105.	115	1	AREA L3	.6	1048.0	-47.0	12.0
BAG, ACCESSORY	80105.1	115	1	AREA U2	.3	1033.0	-23.0	-50.2
BAG, ACCESSORY	80105.1	115	1	AREA B1	.3	1050.0	-27.0	39.0
BAG, ACCESSORY	80105.1	115	1	AREA L3	.3	1048.0	-47.0	12.0
JACKET ASSY, ICG	80112.1	111	1	ON CREW-CMP(LH STA)	1.8	1043.0	-24.5	-10.4
JACKET ASSY, ICG	80112.1	111	1	ON CREW-CDR(CTR. STA)	1.8	1043.0	.0	-10.4
JACKET ASSY, ICG	80112.1	111	1	ON CREW-LMP(RH STA)	1.8	1043.0	24.5	-10.4
TROUSER ASSY, ICG	80112.2	111	1	ON CREW-CMP(LH STA)	1.8	1043.0	-24.5	-10.4
TROUSER ASSY, ICG	80112.2	111	1	ON CREW-CDR(CTR. STA)	1.8	1043.0	.0	-10.4
TROUSER ASSY, ICG	80112.2	111	1	ON CREW-LMP(RH STA)	1.8	1043.0	24.5	-10.4
BOOT, RIGHT, ICG	80112.3	111	1	ON CREW-CMP(LH STA)	.4	1043.0	-24.5	-10.4
BOOT, RIGHT, ICG	80112.3	111	1	ON CREW-CDR(CTR. STA)	.4	1043.0	.0	-10.4
BOOT, RIGHT, ICG	80112.3	111	1	ON CREW-LMP(RH STA)	.4	1043.0	24.5	-10.4
BOOT, LEFT, ICG	80112.4	111	1	ON CREW-CMP(LH STA)	.4	1043.0	-24.5	-10.4
BOOT, LEFT, ICG	80112.4	111	1	ON CREW-CDR(CTR. STA)	.4	1043.0	.0	-10.4
BOOT, LEFT, ICG	80112.4	111	1	ON CREW-LMP(RH STA)	.4	1043.0	24.5	-10.4
OPS CONTROL UNIT ADAPTER	80151.	111	1	AREA A7	1.4	1010.0	23.0	8.0
STRAPS, ATTACH, OPS/PGA	80152.	111	2	AREA A7	NEGL	1010.0	23.0	8.0
STRAPS, ATTACH, OPS/PGA	80153.	111	1	AREA A7	NEGL	1010.0	23.0	8.0

Table 3.5-9.3 (Continued)

MISSION J-1 TRANSFERRED CREW AND EQUIPMENT STOWAGE LIST								
ITEMS REARRANGED IN CM PRIOR TO FIRST MID-COURSE CORRECTION (2)								
APOLLO COORDINATES								
DESCRIPTION	STOW. ITEM	REF	NO.	STOWAGE LOCATION	WEIGHT	X-C.G.	Y-C.G.	Z-C.G.
PANEL IND.-VERB/NOUN LIST	H0104.	115	1	DATA CARD KIT (R3)	.2	1072.0	26.0	9.0
BAG,MOTION SICKNESS	A0208.	111	1	ON PGA(PGA CONTAINR)	.1	1015.0	.0	-19.9
BAG,MOTION SICKNESS	A0208.	111	1	ON PGA(PGA CONTAINR)	.1	1015.0	.0	-19.9
BAG,MOTION SICKNESS	A0208.	111	1	ON PGA(PGA CONTAINR)	.1	1015.0	.0	-19.9
POCKET,CHECKLIST + SCISSORS	80201.5	167	1	ON ICG-CMP./LH STA.	NEGL	1043.0	-24.5	-10.4
VEST,DUAL LIFE	80202.	111	1	IN HSB (U2)	2.4	1033.0	-23.0	-50.2
VEST,DUAL LIFE	80202.	111	1	IN HSB (U2)	NEGL	1033.0	-23.0	-50.2
VEST,DUAL LIFE	80202.	111	1	IN HSB (U2)	NEGL	1033.0	-23.0	-50.2
CONTAINER,R12	00344.	115	1	RH GIRTH RING	2.7	1034.0	41.0	-21.0
EARTUBE,UNIVERSAL	E0105.	111	1	ON ICG-COR./CTR.STA.	NEGL	1043.0	.0	-10.4
EARTUBE,UNIVERSAL	E0105.	111	1	ON ICG-LMP./RH STA.	NEGL	1043.0	24.5	-10.4
EARTUBE,UNIVERSAL	E0105.	111	1	ON ICG-CMP./LH STA.	NEGL	1043.0	-24.5	-10.4
EARPIECE,MOULDED (COM.CARRIER)	E0200.1	111	1	IN HSB (U2)	NEGL	1033.0	-23.0	-50.2
EARTUBE (COM.CARRIER)	E0200.2	111	1	IN HSB (U2)	NEGL	1033.0	-23.0	-50.2
CM EQUIP.RELOC.1					507.91	1035.43	-8.86	-13.23

Table 3.5-9.3 (Continued)

MISSION J-1 TRANSFERRED CREW AND EQUIPMENT STOWAGE LIST								
ITEMS REARRANGED IN CM PRIOR TO LM ACTIVATION (3)								
APOLLO COORDINATES								
DESCRIPTION	STOW. ITEM	REF	NO.	STOWAGE LOCATION	WEIGHT	X-C.G.	Y-C.G.	Z-C.G.
GARMENT, LIQUID COOLING CDR	B0107.	111	1	AREA U1	5.0	1033.0	23.0	-50.0
GARMENT, LIQUID COOLING LMP	B0107.	111	1	AREA U1	5.0	1033.0	23.0	-50.0
SUBSYSTEM, FECAL CONTAINMENT	B0113.	111	1	AREA A2	.3	1010.0	-23.0	8.0
SUBSYSTEM, FECAL CONTAINMENT	B0113.	111	1	AREA A2	.3	1010.0	-23.0	8.0
ADAPTER, CWG ELECTRICAL-CMP	B0135.	111	1	ON CREW-CMP(LH STA)	.4	1043.0	-24.5	-10.4
ADAPTER, CWG ELECTRICAL-COR	B0135.	111	1	ON CREW-COR(CTR. STA)	.4	1043.0	.0	-10.4
ADAPTER, CWG ELECTRICAL-LMP	B0135.	111	1	ON CREW-LMP(RH STA)	.4	1043.0	24.5	-10.4
HEADSET, LIGHT WEIGHT	E0104.	111	1	ON CREW-CMP(LH STA)	.4	1043.0	-24.5	-10.4
HEADSET, LIGHT WEIGHT	E0104.	111	1	ON CREW-COR(CTR. STA)	.4	1043.0	.0	-10.4
HEADSET, LIGHT WEIGHT	E0104.	111	1	ON CREW-LMP(RH STA)	.4	1043.0	24.5	-10.4
UCTA	B0205.	111	1	IN CM PGA CONTAINER	.5	1015.0	.0	-19.9
UCTA	B0205.	111	1	IN CM PGA CONTAINER	.5	1015.0	.0	-19.9
UCTA	B0205.	111	1	IN CM PGA CONTAINER	.5	1015.0	.0	-19.9
ITLSA IV	B0212.	111	1	IN CM PGA CONTAINER	40.4	1015.0	.0	-19.9
ITLSA EV	B0211.	111	1	IN CM PGA CONTAINER	45.0	1015.0	.0	-19.9
ITLSA EV	B0211.	111	1	IN CM PGA CONTAINER	45.0	1015.0	.0	-19.9
GLOVES, IV PAIR	B0213.	111	1	IN HSB (U2)	2.1	1033.0	-23.0	-50.2
GLOVES, IV PAIR	B0213.	111	1	IN HSB (U2)	2.1	1033.0	-23.0	-50.2
GLOVES, IV PAIR	B0213.	111	1	IN HSB (U2)	2.1	1033.0	-23.0	-50.2
HELMET ASSY, PRESSURE	B0214.	111	1	IN HSB (U2)	2.6	1033.0	-23.0	-50.2
HELMET ASSY, PRESSURE	B0214.	111	1	HELMET STOW BAG (B1)	2.6	1050.0	-27.0	39.0
HELMET ASSY, PRESSURE	B0214.	111	1	HELMET STOW BAG (L3)	2.6	1048.0	-47.0	12.0
COMMUNICATION CARRIER	B0217.	111	1	IN HSB (U2)	1.6	1033.0	-23.0	-50.2
COMMUNICATION CARRIER	B0217.	111	1	HELMET STOW BAG (B1)	1.6	1050.0	-27.0	39.0
COMMUNICATION CARRIER	B0217.	111	1	HELMET STOW BAG (L3)	1.6	1048.0	-47.0	12.0
POCKET, CHECKLIST + SCISSORS	B0218.	111	1	ON ICG-COR./CTR. STA.	.2	1043.0	.0	-10.4
POCKET, CHECKLIST + SCISSORS	B0218.	111	1	ON ICG-LMP./RH STA.	.2	1043.0	24.5	-10.4
POCKET, CHECKLIST + SCISSORS	B0218.	111	1	ON ICG-CMP./LH STA.	.2	1043.0	-24.5	-10.4
POCKET, CHECKLIST	B0219.	111	1	ON ICG-COR./CTR. STA.	.2	1043.0	.0	-10.4
POCKET, CHECKLIST	B0219.	111	1	ON ICG-LMP./RH STA.	.2	1043.0	24.5	-10.4
POCKET, CHECKLIST	B0219.	111	1	ON ICG-CMP./LH STA.	.2	1043.0	-24.5	-10.4
DOSIMETER, PASSIVE	D0201.	117	3	CWG POCKET (CREW-COR)	NEGL	1043.0	.0	-10.4

Table 3.5-9.3 (Continued)

MISSION J-1 TRANSFERRED CREW AND EQUIPMENT STOWAGE LIST								
ITEMS REARRANGED IN CM PRIOR TO LM ACTIVATION (3)								
						APOLLO COORDINATES		
DESCRIPTION	STOW. ITEM	REF	NO.	STOWAGE LOCATION	WEIGHT	X-C.G.	Y-C.G.	Z-C.G.
DOSIMETER, PASSIVE	D0201.	117	3	CMG POCKET(CREW-LMP)	NEGL	1043.0	24.5	-10.4
EAPPIECE, MOULDED (COM.CARRIER)	E0200.1	111	1	1N HSB (U2)	NEGL	1033.0	-23.0	-50.2
EAPPIECE, MOULDER (COM.CARRIER)	E0200.1	111	1	1N HSB (U2)	NEGL	1033.0	-23.0	-50.2
EARTUBE (COM.CARRIER)	E0200.2	111	2	1N HSB (U2)	NEGL	1033.0	-23.0	-50.2
EARTUBE (COM.CARRIER)	E0200.2	111	2	HELMET STOW BAG (B1)	NEGL	1050.0	-27.0	39.0
JACKET ASSY, ICG	80112.1	111	1	ON CREW-CMP(LH STA)	1.8	1043.0	-24.5	-10.4
JACKET ASSY, ICG	80112.1	111	1	ON CREW-CDR(CTR.STA)	1.8	1043.0	.0	-10.4
JACKET ASSY, ICG	80112.1	111	1	ON CREW-LMP(RH STA)	1.8	1043.0	24.5	-10.4
TROUSER ASSY, ICG	80112.2	111	1	ON CREW-CMP(LH STA)	1.8	1043.0	-24.5	-10.4
TROUSER ASSY, ICG	80112.2	111	1	ON CREW-CDR(CTR.STA)	1.8	1043.0	.0	-10.4
TROUSER ASSY, ICG	80112.2	111	1	ON CREW-LMP(RH STA)	1.8	1043.0	24.5	-10.4
BOOT, RIGHT, ICG	80112.3	111	1	ON CREW-CMP(LH STA)	.4	1043.0	-24.5	-10.4
BOOT, RIGHT, ICG	80112.3	111	1	ON CREW-CDR(CTR.STA)	.4	1043.0	.0	-10.4
BOOT, RIGHT, ICG	80112.3	111	1	ON CREW-LMP(RH STA)	.4	1043.0	24.5	-10.4
BOOT, LEFT, ICG	80112.4	111	1	ON CREW-CMP(LH STA)	.4	1043.0	-24.5	-10.4
BOOT, LEFT, ICG	80112.4	111	1	ON CREW-CDR(CTR.STA)	.4	1043.0	.0	-10.4
BOOT, LEFT, ICG	80112.4	111	1	ON CREW-LMP(RH STA)	.4	1043.0	24.5	-10.4
BAG, MOTION SICKNESS	A0208.	111	1	ON PGA(PGA CONTAINR)	.1	1015.0	.0	-19.9
BAG, MOTION SICKNESS	A0208.	111	1	ON PGA(PGA CONTAINR)	.1	1015.0	.0	-19.9
BAG, MOTION SICKNESS	A0208.	111	1	ON PGA(PGA CONTAINR)	.1	1015.0	.0	-19.9
EARTUBE, UNIVERSAL	E0105.	111	1	ON ICG-CDR./CTR.STA.	NEGL	1043.0	.0	-10.4
EARTUBE, UNIVERSAL	E0105.	111	1	ON ICG-LMP./RH STA.	NEGL	1043.0	24.5	-10.4
EARTUBE, UNIVERSAL	E0105.	111	1	ON ICG-CMP./LH STA.	NEGL	1043.0	-24.5	-10.4
EAPPIECE, MOULDED (COM.CARRIER)	E0200.1	111	1	1N HSB (U2)	NEGL	1033.0	-23.0	-50.2
EARTUBE (COM.CARRIER)	E0200.2	111	1	1N HSB (U2)	NEGL	1033.0	-23.0	-50.2
SUBSYSTEM, FECAL CONTAINMENT	80113.	111	1	AREA A2	.3	1010.0	-23.0	8.0
GARMENT, CONSTANT WEAR	80208.	111	1	ON CREW-LMP(RH STA)	.8	1043.0	24.5	-10.4
GARMENT, CONSTANT WEAR	80208.	111	1	ON CREW-CDR(CTR.STA)	.8	1043.0	.0	-10.4
WATER SYS ASSY, RETURN CONTIN.	06444.	111	1	1N CM PGA CONTAINER	T80	1015.0	.0	-19.9
CM EQUIP.RELOC.2					180.42	1021.46	-1.79	-20.11

Table 3.5-9.3 (Continued)

MISSION J-1 TRANSFERRED CREW AND EQUIPMENT STOWAGE LIST								
ITEMS REARRANGED IN CM PRIOR TO LM ACTIVATION (4)								
						APOLLO COORDINATES		
DESCRIPTION	STOW. ITEM	REF	NO.	STOWAGE LOCATION	WEIGHT	X-C.G.	Y-C.G.	Z-C.G.
GARMENT, LIQUID COOLING CDR	80107.	111	1	ON CREW-CDR(CTR. STA)	5.0	1043.0	.0	-10.4
GARMENT, LIQUID COOLING LMP	80107.	111	1	ON CREW-LMP(RH STA)	5.0	1043.0	24.5	-10.4
SUBSYSTEM, FECAL CONTAINMENT	80113.	111	1	ON CREW-CDR(CTR. STA)	.3	1043.0	.0	-10.4
SUBSYSTEM, FECAL CONTAINMENT	80113.	111	1	ON CREW-LMP(RH STA)	.3	1043.0	24.5	-10.4
ADAPTER, CWG ELECTRICAL-CMP	80135.	111	1	IN ADAPTER BAG (AB)	.4	1012.0	22.0	-23.0
ADAPTER, CWG ELECTRICAL-CDR	80135.	111	1	IN ADAPTER BAG (AB)	.4	1012.0	22.0	-23.0
ADAPTER, CWG ELECTRICAL-LMP	80135.	111	1	IN ADAPTER BAG (AB)	.4	1012.0	22.0	-23.0
HEADSET, LIGHT WEIGHT	E0104.	111	1	AREA AB	.4	1012.0	22.0	-23.0
HEADSET, LIGHT WEIGHT	E0104.	111	1	AREA AB	.4	1012.0	22.0	-23.0
HEADSET, LIGHT WEIGHT	E0104.	111	1	AREA AB	.4	1012.0	22.0	-23.0
UCTA	80205.	111	1	ON CREW-LMP(RH STA)	.5	1043.0	24.5	-10.4
UCTA	80205.	111	1	ON CREW-CDR(CTR. STA)	.5	1043.0	.0	-10.4
UCTA	80205.	111	1	ON CREW-CMP(LH STA)	.5	1043.0	-24.5	-10.4
ITLSA IV	80212.	111	1	ON CREW-CMP(LH STA)	40.4	1043.0	-24.5	-10.4
ITLSA EV	80211.	111	1	ON CREW-LMP(RH STA)	45.0	1043.0	24.5	-10.4
ITLSA EV	80211.	111	1	ON CREW-CDR(CTR. STA)	45.0	1043.0	.0	-10.4
GLOVES, IV PAIR	80213.	111	1	ON CREW-CMP(LH STA)	2.1	1043.0	-24.5	-10.4
GLOVES, IV PAIR	80213.	111	1	ON CREW-LMP(RH STA)	2.1	1043.0	24.5	-10.4
GLOVES, IV PAIR	80213.	111	1	ON CREW-CDR(CTR. STA)	2.1	1043.0	.0	-10.4
HELMET ASSY, PRESSURE	80214.	111	1	ON CREW-CMP(LH STA)	2.6	1043.0	-24.5	-10.4
HELMET ASSY, PRESSURE	80214.	111	1	ON CREW-LMP(RH STA)	2.6	1043.0	24.5	-10.4
HELMET ASSY, PRESSURE	80214.	111	1	ON CREW-CDR(CTR. STA)	2.6	1043.0	.0	-10.4
COMMUNICATION CARRIER	80217.	111	1	ON CREW-CMP(LH STA)	1.6	1043.0	-24.5	-10.4
COMMUNICATION CARRIER	80217.	111	1	ON CREW-LMP(RH STA)	1.6	1043.0	24.5	-10.4
COMMUNICATION CARRIER	80217.	111	1	ON CREW-CDR(CTR. STA)	1.6	1043.0	.0	-10.4
POCKET, CHECKLIST + SCISSORS	80218.	111	1	ON PGA (CREW-RH STA)	.2	1043.0	24.5	-10.4
POCKET, CHECKLIST + SCISSORS	80219.	111	1	ON PGA (CREW-LH STA)	.2	1043.0	-24.5	-10.4
POCKET, CHECKLIST + SCISSORS	80218.	111	1	ON PGA(CREW-CTR STA)	.2	1043.0	.0	-10.4
POCKET, CHECKLIST	80219.	111	1	ON PGA (CREW-RH STA)	.2	1043.0	24.5	-10.4
POCKET, CHECKLIST	80219.	111	1	ON PGA (CREW-LH STA)	.2	1043.0	-24.5	-10.4
POCKET, CHECKLIST	80219.	111	1	ON PGA(CREW-CTR STA)	.2	1043.0	.0	-10.4
DOSIMETER, PASSIVE	00201.	117	3	CWG POCKET(STOWED)	NEGL	1015.0	.0	-19.0

Table 3.5-9.3 (Continued)

MISSION J-1 TRANSFERRED CREW AND EQUIPMENT STOWAGE LIST								
ITEMS REARRANGED IN CM PRIOR TO LM ACTIVATION (4)								
APOLLO COORDINATES								
DESCRIPTION	STOW. ITEM	REF	NO.	STOWAGE LOCATION	WEIGHT	X-C.G.	Y-C.G.	Z-C.G.
DOSIMETER, PASSIVE	00201.	117	3	CMG POCKET (STOWED)	NEGL	1015.0	.0	-19.0
EARPIECE, MOULDED (COM.CARRIER)	E0200.1	111	1	ON CREW-LMP(RH STA)	NEGL	1043.0	24.5	-10.4
EARPIECE, MOULDER (COM.CARRIER)	E0200.1	111	1	ON CREW-COR(CTR.STA)	NEGL	1043.0	.0	-10.4
EARTUBE (COM.CARRIER)	E0200.2	111	2	ON CREW-LMP(RH STA)	NEGL	1043.0	24.5	-10.4
EARTUBE (COM.CARRIER)	E0200.2	111	2	ON CREW-COR(CTR.STA)	NEGL	1043.0	.0	-10.4
JACKET ASSY, ICG	80112.1	111	1	AREA U2	1.8	1033.0	-23.0	-50.2
JACKET ASSY, ICG	80112.1	111	1	AREA U2	1.8	1033.0	-23.0	-50.2
JACKET ASSY, ICG	80112.1	111	1	AREA U2	1.8	1033.0	-23.0	-50.2
TROUSER ASSY, ICG	80112.2	111	1	AREA U2	1.8	1033.0	-23.0	-50.2
TROUSER ASSY, ICG	80112.2	111	1	AREA U2	1.8	1033.0	-23.0	-50.2
TROUSER ASSY, ICG	80112.2	111	1	AREA U2	1.8	1033.0	-23.0	-50.2
BOOT, RIGHT, ICG	80112.3	111	1	AREA U2	.4	1033.0	-23.0	-50.2
BOOT, RIGHT, ICG	80112.3	111	1	AREA U2	.4	1033.0	-23.0	-50.2
BOOT, RIGHT, ICG	80112.3	111	1	AREA U2	.4	1033.0	-23.0	-50.2
BOOT, LEFT, ICG	80112.4	111	1	AREA U2	.4	1033.0	-23.0	-50.2
BOOT, LEFT, ICG	80112.4	111	1	AREA U2	.4	1033.0	-23.0	-50.2
BOOT, LEFT, ICG	80112.4	111	1	AREA U2	.4	1033.0	-23.0	-50.2
BAG, MOTION SICKNESS	A0208.	111	1	ON PGA (CREW-RH STA)	.1	1043.0	24.5	-10.4
BAG, MOTION SICKNESS	A0208.	111	1	ON PGA (CREW-LH STA)	.1	1043.0	-24.5	-10.4
BAG, MOTION SICKNESS	A0208.	111	1	ON PGA (CREW-CTR STA)	.1	1043.0	.0	-10.4
EARTUBE, UNIVERSAL	E0105.	111	1	AREA U2	NEGL	1033.0	-23.0	-50.2
EARTUBE, UNIVERSAL	E0105.	111	1	AREA U2	NEGL	1033.0	-23.0	-50.2
EARTUBE, UNIVERSAL	E0105.	111	1	AREA U2	NEGL	1033.0	-23.0	-50.2
EARPIECE, MOULDED (COM.CARRIER)	E0200.1	111	1	ON CREW-CMP(LH STA)	NEGL	1043.0	-24.5	-10.4
EARTUBE (COM.CARRIER)	E0200.2	111	1	ON CREW-CMP(LH STA)	NEGL	1043.0	-24.5	-10.4
SUBSYSTEM, FECAL CONTAINMENT	80113.	111	1	ON CREW-CMP(LH STA)	.3	1043.0	-24.5	-10.4
GARMENT, CONSTANT WEAR	80208.	111	1	AREA U2	.8	1033.0	-23.0	-50.2
GARMENT, CONSTANT WEAR	80208.	111	1	AREA U2	.8	1033.0	-23.0	-50.2
WATER SYS ASSY, RETURN CONTIN.	06444.	111	1	AFT UEB CENTER (APRX	T80	1018.0	.0	-48.9
CM EQUIP. RELOC. 2					180.42	1041.77	-2.29	-13.84

Table 3.5-9.3 (Continued)

MISSION J-1 TRANSFERRED CREW AND EQUIPMENT STOWAGE LIST								
ITEMS TRANSFERRED FROM CM INTO LM AT LM ACTIVATION (5)								
APOLLO COORDINATES								
DESCRIPTION	STOW. ITEM	REF	NO.	STOWAGE LOCATION	WEIGHT	X-C.G.	Y-C.G.	Z-C.G.
CREW-COMMANDER (CDR)	T8D	227	1	ON COUCH(CTR CRW STA	167.0	1043.0	.0	-10.4
CREW-LM PILOT (LMP)	T8D	227	1	ON COUCH(RH CREW STA	173.0	1043.0	24.5	-10.4
LM LUNAR SURFACE CHECKLIST	A0114.10	114	1	IN FDF (R3)	1.0	1072.0	26.0	9.0
LM SYSTEMS ACTIVATION CHK.LST.	A0114.12	114	1	IN FDF (R3)	.5	1072.0	26.0	9.0
LM SYSTEMS ACTIVATION CHK.LST.	AQ114.12	114	1	IN FDF (R3)	.5	1072.0	26.0	9.0
LM LUNAR SURFACE MAPS	A0114.13	114	1	IN FDF (R3)	1.5	1072.0	26.0	9.0
LM TIMELINE BOOK	A0114.14	114	1	IN FDF (R3)	.5	1072.0	26.0	9.0
LM XFR DATA CARD KIT	A0114.18	114	1	IN FDF (R3)	.6	1072.0	26.0	9.0
LM DATA CARD BOOK	A0114.19	114	1	IN FDF (R3)	.3	1072.0	26.0	9.0
LM RNDZ/ABORT BOOK	A0114.22	114	1	IN FDF (R3)	.3	1072.0	26.0	9.0
MONOCULAR 10X40	A0130.	116	1	AREA U4	.7	1038.0	39.0	-43.0
GARMENT,LIQUID COOLING CDR	B0107.	111	1	ON CREW-CDR(CTR.STA)	5.0	1043.0	.0	-10.4
GARMENT,LIQUID COOLING LMP	B0107.	111	1	ON CREW-LMP(RH STA)	5.0	1043.0	24.5	-10.4
SUBSYSTEM,FECAL CONTAINMENT	B0113.	111	1	ON CREW-CDR(CTR.STA)	.3	1043.0	.0	-10.4
SUBSYSTEM,FECAL CONTAINMENT	B0113.	111	1	ON CREW-LMP(RH STA)	.3	1043.0	24.5	-10.4
ADAPTER,CWG ELECTRICAL-CDR	B0135.	111	1	IN ADAPTER BAG (A8)	.4	1012.0	22.0	-23.0
ADAPTER,CWG ELECTRICAL-LMP	B0135.	111	1	IN ADAPTER BAG (A8)	.4	1012.0	22.0	-23.0
DOSIMETER, PASSIVE RADIATION	D0101.	111	1	IN XFR BAG (R13)	NEGL	1024.0	45.0	-26.0
HEADSET, LIGHT WEIGHT	E0104.	111	1	AREA A8	.4	1012.0	22.0	-23.0
HEADSET, LIGHT WEIGHT	E0104.	111	1	AREA A8	.4	1012.0	22.0	-23.0
SUNGLASSES	A0200.	117	1	ON CREW-CDR(CTR.STA)	.1	1043.0	.0	-10.4
SUNGLASSES	A0200.	117	1	ON CREW-LMP(RH STA)	.1	1043.0	24.5	-10.4
POUCH,SUNGLASSES	A0201.	117	1	ON CREW-CDR(CTR.STA)	NEGL	1043.0	.0	-10.4
POUCH,SUNGLASSES	A0201.	117	1	ON CREW-LMP(RH STA)	NEGL	1043.0	24.5	-10.4
CHRONOGRAPH * -002	A0202.	117	1	ON CREW-CDR(CTR.STA)	.1	1043.0	.0	-10.4
CHRONOGRAPH * -002	A0202.	117	1	ON CREW-LMP(RH STA)	.1	1043.0	24.5	-10.4
WATCHBAND	A0203.	117	1	ON CREW-CDR(CTR.STA)	NEGL	1043.0	.0	-10.4
WATCHBAND	A0203.	117	1	ON CREW-LMP(RH STA)	NEGL	1043.0	24.5	-10.4
PENS,DATA RECORDING	A0204.	117	1	ON CREW-CDR(CTR.STA)	.1	1043.0	.0	-10.4
PENS,DATA RECORDING	A0204.	117	1	ON CREW-LMP(RH STA)	.1	1043.0	24.5	-10.4
PEN, MARKER	A0205.	117	1	ON CREW-CDR(CTR.STA)	NEGL	1043.0	.0	-10.4
PEN, MARKER	A0205.	117	1	ON CREW-LMP(RH STA)	NEGL	1043.0	24.5	-10.4

Table 3.5-9.3 (Continued)

MISSION J-1 TRANSFERRED CREW AND EQUIPMENT STORAGE LIST								
ITEMS TRANSFERRED FROM CM INTO LM AT LM ACTIVATION (5)								
APOLLO COORDINATES								
DESCRIPTION	STOW. ITEM	REF	NO.	STORAGE LOCATION	WEIGHT	X-C.G.	Y-C.G.	Z-C.G.
PENCIL	A0206.	117	1	ON CREW-CDR(CTR.STA)	.1	1043.0	.0	-10.4
PENCIL	A0206.	117	1	ON CREW-LMP(RH STA)	.1	1043.0	24.5	-10.4
ASSY, BIOINSTRUMENTATION	B0203.	111	1	ON CREW-CDR(CTR.STA)	1.1	1043.0	.0	-10.4
ASSY, BIOINSTRUMENTATION	B0203.	111	1	ON CREW-LMP(RH STA)	1.1	1043.0	24.5	-10.4
SCISSORS	B0204.	111	1	ON CREW-CDR(CTR.STA)	.5	1043.0	.0	-10.4
UCTA	B0205.	111	1	ON CREW-LMP(RH STA)	.5	1043.0	24.5	-10.4
UCTA	B0205.	111	1	ON CREW-CDR(CTR.STA)	.5	1043.0	.0	-10.4
PENLIGHTS	B0206.	117	1	ON CREW-LMP(RH STA)	.3	1043.0	24.5	-10.4
PENLIGHTS	B0206.	117	1	ON CREW-CDR(CTR.STA)	.3	1043.0	.0	-10.4
ASSY. BIOBELT	B0207.	117	1	ON CREW-LMP(RH STA)	.2	1043.0	24.5	-10.4
ASSY. BIOBELT	B0207.	117	1	ON CREW-CDR(CTR.STA)	.2	1043.0	.0	-10.4
EARPLUGS, PAIR	B0210.	111	1	ON CREW-LMP(RH STA)	NEGL	1043.0	24.5	-10.4
EARPLUGS, PAIR	B0210.	111	1	ON CREW-CDR(CTR.STA)	NEGL	1043.0	.0	-10.4
ITLSA EV	B0211.	111	1	ON CREW-LMP(RH STA)	45.0	1043.0	24.5	-10.4
ITLSA EV	B0211.	111	1	ON CREW-CDR(CTR.STA)	45.0	1043.0	.0	-10.4
GLOVES, IV PAIR	B0213.	111	1	ON CREW-LMP(RH STA)	2.1	1043.0	24.5	-10.4
GLOVES, IV PAIR	B0213.	111	1	ON CREW-CDR(CTR.STA)	2.1	1043.0	.0	-10.4
HELMET ASSY, PRESSURE	B0214.	111	1	ON CREW-LMP(RH STA)	2.6	1043.0	24.5	-10.4
HELMET ASSY, PRESSURE	B0214.	111	1	ON CREW-CDR(CTR.STA)	2.6	1043.0	.0	-10.4
HARNESS, ELEC.-SUIT	B0215.	111	1	ON CREW-CDR(CTR.STA)	.5	1043.0	.0	-10.4
HARNESS, ELEC.-SUIT	B0215.	111	1	ON CREW-LMP(RH STA)	.5	1043.0	24.5	-10.4
HARNESS, BIOINSTRUMENTATION	B0216.	111	1	ON CREW-CDR(CTR.STA)	.3	1043.0	.0	-10.4
HARNESS, BIOINSTRUMENTATION	B0216.	111	1	ON CREW-LMP(RH STA)	.3	1043.0	24.5	-10.4
COMMUNICATION CARRIER	B0217.	111	1	ON CREW-LMP(RH STA)	1.6	1043.0	24.5	-10.4
COMMUNICATION CARRIER	B0217.	111	1	ON CREW-CDR(CTR.STA)	1.6	1043.0	.0	-10.4
POCKET, CHECKLIST + SCISSORS	B0218.	111	1	ON PGA (CREW-RH STA)	.2	1043.0	24.5	-10.4
POCKET, CHECKLIST + SCISSORS	B0218.	111	1	ON PGA (CREW-CTR STA)	.2	1043.0	.0	-10.4
POCKET, CHECKLIST	B0219.	111	1	ON PGA (CREW-RH STA)	.2	1043.0	24.5	-10.4
POCKET, CHECKLIST	B0219.	111	1	ON PGA (CREW-CTR STA)	.2	1043.0	.0	-10.4
DOSIMETER, PERSONAL	00200.	117	1	ON CREW-CDR(CTR.STA)	.4	1043.0	.0	-10.4
DOSIMETER, PERSONAL	00200.	117	1	ON CREW-LMP(RH STA)	.4	1043.0	24.5	-10.4
DOSIMETER, PASSIVE	00201.	117	3	CWG POCKET (STOWED)	NEGL	1015.0	.0	-19.0

Table 3.5-9.3 (Continued)

MISSION J-1 TRANSFERRED CREW AND EQUIPMENT STOWAGE LIST								
ITEMS TRANSFERRED FROM CM INTO LM AT LM ACTIVATION (5)								
APOLLO COORDINATES								
DESCRIPTION	STOW. ITEM	REF	NO.	STOWAGE LOCATION	WEIGHT	X-C.G.	Y-C.G.	Z-C.G.
DOSIMETER, PASSIVE	D0201.	117	3	CMG POCKET (STOWED)	NEGL	1015.0	.0	-19.0
EARPIECE, MOULDED (COM.CARRIER)	E0200.1	111	1	ON CREW-CDR (CTR. STA)	NEGL	1043.0	.0	-10.4
EARPIECE, MOULDER (COM.CARRIER)	ED200.1	111	1	ON CREW-LMP (RH STA)	NEGL	1043.0	24.5	-10.4
EARTUBE (COM.CARRIER)	E0200.2	111	2	ON CREW-COR (CTR. STA)	NEGL	1043.0	.0	-10.4
EARTUBE (COM.CARRIER)	E0200.2	111	2	ON CREW-LMP (RH STA)	NEGL	1043.0	24.5	-10.4
BAG, XFER, 16MM MAG (6)	O6397.	111	1	IN XFR BAG (R13)	.3	1024.0	45.0	-26.0
BAG, XFER, 70MM MAG (4)	O6398.	111	1	IN XFR BAG (R13)	.3	1024.0	45.0	-26.0
MAGAZINE, L.S. HASSELBLAD	A0108.1	116	3	AREA R13	4.2	1024.0	45.0	-26.0
MAGAZINE, L.S. HASSELBLAD	A0108.1	116	1	AREA R13	1.4	1024.0	45.0	-26.0
MAGAZINE, L.S. HASSELBLAD	A0108.1	116	3	AREA R13	4.2	1024.0	45.0	-26.0
MAGAZINE, 16MM DATA ACQ.	A0101.1	116	5	AREA R13	5.0	1024.0	45.0	-26.0
MAGAZINE, 16MM DATA ACQ.	A0101.1	116	2	AREA R13	2.0	1024.0	45.0	-26.0
MAGAZINE, 16MM DATA ACQ.	A0101.1	116	1	AREA R13	1.0	1024.0	45.0	-26.0
BAG, TRANSFER-16MM MAG.(2)	O6432.	111	1	AREA R13	.1	1024.0	45.0	-26.0
BAG, TRANSFER-70MM MAG (3)	O6434.	111	1	AREA R13	.5	1024.0	45.0	-26.0
2 CREW+EQUIP, CM-LM					488.41	1042.46	13.88	-10.89

Table 3.5-9.3 (Continued)

MISSION J-1 TRANSFERRED CREW AND EQUIPMENT STORAGE LIST								
ITEMS TRANSFERRED FROM CM INTO LM AT LM ACTIVATION (6)								
DESCRIPTION	STOW. ITEM	REF	NO.	STOWAGE LOCATION	WEIGHT	LM COORDINATES		
						X-C.G.	Y-C.G.	Z-C.G.
CREW-COMMANDER (CDR)	TBD	227	1	LM CREW STATION-	167.0	260.0	-22.0	45.0
CREW-LM PILOT (LMP)	TBD	227	1	R4 CREW STATION-	173.0	260.0	22.0	45.0
LM LUNAR SURFACE CHECKLIST	A0114.10	114	1	LM XFR DATA CARD KIT	1.0	280.8	-20.0	14.0
LM SYSTEMS ACTIVATION CHK.LST.	A0114.12	114	1	LM XFR DATA CARD KIT	.5	280.8	-20.0	14.0
LM SYSTEMS ACTIVATION CHK.LST.	A0114.12	114	1	LM XFR DATA CARD KIT	.5	280.8	-20.0	14.0
LM LUNAR SURFACE MAPS	A0114.13	114	1	LM XFR DATA CARD KIT	1.5	280.8	-20.0	14.0
LM TIMELINE BOOK	A0114.14	114	1	LM XFR DATA CARD KIT	.5	280.8	-20.0	14.0
LM XFR DATA CARD KIT	A0114.18	114	1	LM XFR DATA CARD KIT	.6	280.8	-20.0	14.0
LM DATA CARD BOOK	A0114.19	114	1	LM XFR DATA CARD KIT	.3	280.8	-20.0	14.0
LM RNOZ/ABORT BOOK	A0114.22	114	1	LM XFR DATA CARD KIT	.3	280.8	-20.0	14.0
MONOCULAR 10X40	A0130.	116	1	F7B	.7	238.0	38.0	49.8
GARMENT, LIQUID COOLING CDR	B0107.	111	1	ON CREW(LH CREW STA)	5.0	260.0	-22.0	45.0
GARMENT, LIQUID COOLING LMP	B0107.	111	1	ON CREW(RH CREW STA)	5.0	260.0	-22.0	45.0
SUBSYSTEM, FECAL CONTAINMENT	B0113.	111	1	ON CREW(LH CREW STA)	.3	260.0	-22.0	45.0
SUBSYSTEM, FECAL CONTAINMENT	B0113.	111	1	ON CREW(RH CREW STA)	.3	260.0	22.0	45.0
ADAPTER, CWG ELECTRICAL-COR	B0135.	111	1	F1E	.4	237.9	-33.6	55.0
ADAPTER, CWG ELECTRICAL-LMP	B0135.	111	1	F1E	.4	237.9	-33.6	55.0
DOSIMETER, PASSIVE RADIATION	D0101.	111	1	F7L	NEGL	236.0	36.0	48.0
HEADSET, LIGHT WEIGHT	E0104.	111	1	F1B	.4	235.5	-35.5	38.5
HEADSET, LIGHT WEIGHT	E0104.	111	1	F1B	.4	235.5	-35.5	38.5
SUNGLASSES	A0200.	117	1	ON CREW(LH CREW STA)	.1	260.0	-22.0	45.0
SUNGLASSES	A0200.	117	1	ON CREW(RH CREW STA)	.1	260.0	22.0	45.0
POUCH, SUNGLASSES	A0201.	117	1	ON CREW(LH CREW STA)	NEGL	260.0	-22.0	45.0
POUCH, SUNGLASSES	A0201.	117	1	ON CREW(RH CREW STA)	NEGL	260.0	22.0	45.0
CHRONOGRAPH * -002	A0202.	117	1	ON CREW(LH CREW STA)	.1	260.0	-22.0	45.0
CHRONOGRAPH * -002	A0202.	117	1	ON CREW(RH CREW STA)	.1	260.0	22.0	45.0
WATCHBAND	A0203.	117	1	ON CREW(LH CREW STA)	NEGL	260.0	-22.0	45.0
WATCHBAND	A0203.	117	1	ON CREW(RH CREW STA)	NEGL	260.0	22.0	45.0
PENS, DATA RECORDING	A0204.	117	1	ON CREW(LH CREW STA)	.1	260.0	-22.0	45.0
PENS, DATA RECORDING	A0204.	117	1	ON CREW(RH CREW STA)	.1	260.0	22.0	45.0
PEN, MARKER	A0205.	117	1	ON CREW(LH CREW STA)	NEGL	260.0	-22.0	45.0
PEN, MARKER	A0205.	117	1	ON CREW(RH CREW STA)	NEGL	260.0	22.0	45.0

Table 3.5-9.3 (Continued)

MISSION J-1 TRANSFERRED CREW AND EQUIPMENT STOWAGE LIST								
ITEMS TRANSFERRED FROM CM INTO L4 AT LM ACTIVATION (6)								
						LM COORDINATES		
DESCRIPTION	STOW. ITEM	REF	NO.	STOWAGE LOCATION	WEIGHT	X-C.G.	Y-C.G.	Z-C.G.
PENCIL	A0206.	117	1	ON CREW(LH CREW STA)	.1	260.0	-22.0	45.0
PENCIL	A0206.	117	1	ON CREW(RH CREW STA)	.1	260.0	22.0	45.0
ASSY, BIOINSTRUMENTATION	80203.	111	1	ON CREW(LH CREW STA)	1.1	260.0	-22.0	45.0
ASSY, BIOINSTRUMENTATION	80203.	111	1	ON CREW(RH CREW STA)	1.1	260.0	22.0	45.0
SCISSORS	80204.	111	1	ON CREW(LH CREW STA)	.5	260.0	-22.0	45.0
UCTA	80205.	111	1	ON PGA-L4P(ON CREW)	.5	250.6	22.0	43.4
UCTA	80205.	111	1	ON PGA-COR(ON CREW)	.5	250.6	-22.0	43.4
PENLIGHTS	80206.	117	1	ON CREW(RH CREW STA)	.3	260.0	22.0	45.0
PENLIGHTS	80206.	117	1	ON CREW(LH CREW STA)	.3	260.0	-22.0	45.0
ASSY. BIOBELT	80207.	117	1	ON CREW(RH CREW STA)	.2	260.0	22.0	45.0
ASSY. BIOBELT	80207.	117	1	ON CREW(LH CREW STA)	.2	260.0	-22.0	45.0
EARPLUGS, PAIR	80210.	111	1	ON CREW(RH CREW STA)	NEGL	260.0	22.0	45.0
EARPLUGS, PAIR	80210.	111	1	ON CREW(LH CREW STA)	NEGL	260.0	-22.0	45.0
ITLSA EV	80211.	111	1	ON CREW(RH CREW STA)	45.0	260.0	22.0	45.0
ITLSA EV	80211.	111	1	ON CREW(LH CREW STA)	45.0	260.0	-22.0	45.0
GLOVES, IV PAIR	80213.	111	1	ON CREW(RH CREW STA)	2.1	260.0	22.0	45.0
GLOVES, IV PAIR	80213.	111	1	ON CREW(LH CREW STA)	2.1	260.0	-22.0	45.0
HELMET ASSY, PRESSURE	80214.	111	1	ON CREW(RH CREW STA)	2.6	260.0	22.0	45.0
HELMET ASSY, PRESSURE	80214.	111	1	ON CREW(LH CREW STA)	2.6	260.0	-22.0	45.0
HARNESS, ELEC.-SUIT	80215.	111	1	ON CREW(RH CREW STA)	.5	260.0	22.0	45.0
HARNESS, ELEC.-SUIT	80215.	111	1	ON CREW(LH CREW STA)	.5	260.0	-22.0	45.0
HARNESS, BIOINSTRUMENTATION	80216.	111	1	ON CREW(RH CREW STA)	.3	260.0	22.0	45.0
HARNESS, BIOINSTRUMENTATION	80216.	111	1	ON CREW(LH CREW STA)	.3	260.0	-22.0	45.0
COMMUNICATION CARRIER	80217.	111	1	ON CREW(RH CREW STA)	1.6	260.0	22.0	45.0
COMMUNICATION CARRIER	80217.	111	1	ON CREW(LH CREW STA)	1.6	260.0	-22.0	45.0
POCKET, CHECKLIST + SCISSORS	80218.	111	1	ON CREW(RH CREW STA)	.2	260.0	22.0	45.0
POCKET, CHECKLIST + SCISSORS	80218.	111	1	ON CREW(LH CREW STA)	.2	260.0	-22.0	45.0
POCKET, CHECKLIST	80219.	111	1	ON CREW(RH CREW STA)	.2	260.0	22.0	45.0
POCKET, CHECKLIST	80219.	111	1	ON CREW(LH CREW STA)	.2	260.0	-22.0	45.0
DOSIMETER, PERSONAL	00200.	117	1	ON CREW(RH CREW STA)	.4	260.0	22.0	45.0
DOSIMETER, PERSONAL	00200.	117	1	ON CREW(LH CREW STA)	.4	260.0	-22.0	45.0
DOSIMETER, PASSIVE	00201.	117	3	ON CREW(RH CREW STA)	NEGL	260.0	22.0	45.0

Table 3.5-9.3 (Continued)

MISSION J-1 TRANSFERRED CREW AND EQUIPMENT STOWAGE LIST								
ITEMS TRANSFERRED FROM CM INTO LM AT LM ACTIVATION (6)								
LM COORDINATES								
DESCRIPTION	STOW. ITEM	REF	NO.	STOWAGE LOCATION	WEIGHT	X-C.G.	Y-C.G.	Z-C.G.
DOSIMETER, PASSIVE	00201.	117	3	ON CREW(LH CREW STA)	NEGL	260.0	-22.0	45.0
EARPIECE, MOULDED (COM.CARRIER)	E0200.1	111	1	ON CREW(RH CREW STA)	NEGL	260.0	22.0	45.0
EARPIECE, MOULDER (COM.CARRIER)	E0200.1	111	1	ON CREW(LH CREW STA)	NEGL	260.0	-22.0	45.0
EARTUBE (COM.CARRIER)	E0200.2	111	2	ON CREW(RH CREW STA)	NEGL	260.0	22.0	45.0
EARTUBE (COM.CARRIER)	E0200.2	111	2	ON CREW(LH CREW STA)	NEGL	260.0	-22.0	45.0
BAG, XFER, 16MM MAG (6)	06397.	111	1	F7L	.3	236.0	36.0	48.0
BAG, XFER, 70MM MAG (4)	06398.	111	1	F70	.3	238.0	38.0	38.4
MAGAZINE, L.S. HASSELBLAD	A0108.1	116	3	F70	4.2	238.0	38.0	38.4
MAGAZINE, L.S. HASSELBLAD	A0108.1	116	1	F7C	1.4	238.0	38.0	41.0
MAGAZINE, L.S. HASSELBLAD	A0108.1	116	3	F70	4.2	238.0	38.0	38.4
MAGAZINE, 16MM DATA ACQ.	A0101.1	116	5	F7L	5.0	236.0	36.0	48.0
MAGAZINE, 16MM DATA ACQ.	A0101.1	116	2	ISA (F6)	2.0	270.0	.0	52.8
MAGAZINE, 16MM DATA ACQ.	A0101.1	116	1	F5	1.0	286.0	17.8	66.6
BAG, TRANSFER-16MM MAG.(2)	06432.	111	1	ISA (F6)	.1	270.0	.0	52.8
BAG, TRANSFER-70MM MAG (3)	06434.	111	1	F7P	.5	238.0	38.0	53.4
2 CREW*EQUIP, CM-LM					488.41	259.45	1.23	44.67

Table 3.5-9.3 (Continued)

MISSION J-1 TRANSFERRED CREW AND EQUIPMENT STORAGE LIST								
ITEMS TRANSFERRED FROM LM INTO CM AT LM ACTIVATION (8)								
APOLLO COORDINATES								
DESCRIPTION	STOW. ITEM	REF	NO.	STOWAGE LOCATION	WEIGHT	X-C.G.	Y-C.G.	Z-C.G.
CSM/LM UMBILICAL	TBD	222	1	UNDER RH COUCH	1.1	1018.0	24.5	-15.0
EQUIP.XFR,LM-CM 1					1.10	1018.00	24.50	-15.00

U
N
I
T
E
D
S
T
A
T
E
S
O
F
A
M
E
R
I
C
A

Amendment 94
12/10/70

Table 3.5-9.3 (Continued)

MISSION J-1 TRANSFERRED CREW AND EQUIPMENT STOWAGE LIST								
ITEMS REARRANGED IN LM PRIOR TO LM ACTIVATION (9)								
DESCRIPTION	STOW. ITEM	REF	NO.	STOWAGE LOCATION	WEIGHT	LM COORDINATES		
						X-C.G.	Y-C.G.	Z-C.G.
BRACKET, WEDGE, 16MM CAMERA	A1041.	115	1	F7A	1.3	238.0	38.0	49.8
INTERIM STOWAGE ASSY.	O3007.	111	1	F6	7.6	270.0	.0	52.8
MAGAZINE, 16MM DATA ACQ.	A0101.1	116	2	ISA (F6)	2.0	270.0	.0	52.8
BAG, TRANSFER-16MM MAG.(2)	O6432.	111	1	ISA (F6)	.1	270.0	.0	52.8
LM EQUIP.RELOC.1					11.00	266.22	4.49	52.45

Table 3.5-9.3 (Continued)

MISSION J-1 TRANSFERRED CREW AND EQUIPMENT STOWAGE LIST								
ITEMS REARRANGED IN LM PRIOR TO LM ACTIVATION (10)								
DESCRIPTION	STOW. ITEM	REF	NO.	STOWAGE LOCATION	WEIGHT	LM COORDINATES		
						X-C.G.	Y-C.G.	Z-C.G.
BRACKET, WEDGE, 16MM CAMERA	A1041.	115	1	F5	1.3	286.0	17.8	66.6
INTERIM STOWAGE ASSY.	03007.	111	1	A1D	7.6	270.3	-15.0	19.0
MAGAZINE, 16MM DATA ACQ.	A0101.1	116	2	ISA (A1D)	2.0	270.3	-15.0	19.0
BAG, TRANSFER-16MM MAG.(2)	06432.	111	1	ISA (A1D)	.1	270.3	-15.0	19.0
LM EQUIP.RELOC.1					11.00	272.16	-11.12	24.63

Table 3.5-9.3 (Continued)

MISSION J-1 TRANSFERRED CREW AND EQUIPMENT STOWAGE LIST								
ITEMS OFFLOADED FROM ASC. STAGE PRIOR TO LUNAR LIFT-OFF (11)								
						LM COORDINATES		
DESCRIPTION	STOW. ITEM	REF	NO.	STOWAGE LOCATION	WEIGHT	X-C.G.	Y-C.G.	Z-C.G.
LM SYSTEMS ACTIVATION CHK.LST.	A0114.12	114	1	LM XFR DATA CARD KIT	.5	280.8	-20.0	14.0
GARMENT, LIQUID COOLING COR	B0107.	111	1	ON CREW(LM CREW STA)	5.0	260.0	-22.0	45.0
GARMENT, LIQUID COOLING LMP	B0107.	111	1	ON CREW(RH CREW STA)	5.0	260.0	22.0	45.0
EARPLUGS, PAIR	B0210.	111	1	ON CREW(RH CREW STA)	NEGL	260.0	22.0	45.0
EARPLUGS, PAIR	B0210.	111	1	ON CREW(LM CREW STA)	NEGL	260.0	-22.0	45.0
CONTR.CONTINGMNCY,LUN.SAM.RTN.	G4016.	115	1	A1G	.7	257.5	-20.0	-18.0
CAMERA, L.S. HASSELBLAD	A1015.	115	1	F7C	3.6	238.0	38.0	41.0
LENS, 60 MM	A1016.	115	1	F7C	1.8	238.0	38.0	41.0
ADAPTER, BRKT,RT,ANGLE 16MM	A1021.	115	1	F7H	.2	238.0	38.0	45.5
CABLE, REMOTE, CONTROL,16MMCAM	A1022.	115	1	F7H	.7	238.0	38.0	45.5
PROTECTIVE COVERA, RESEAU	A1023.	115	1	F7C	.2	238.0	38.0	41.0
TRIGGER, ELECT. HASSELBLAD	A1027.	115	1	F7C	.2	238.0	38.0	41.0
HANDLE,, ELECT. HASSELBLAD	A1028.	115	1	F7C	.5	238.0	38.0	41.0
CHECKLIST, EVA CUFF	A1040.	115	1	F8	.3	221.0	18.0	51.0
CHECKLIST, EVA CUFF	A1040.	115	1	F10	.3	221.0	-18.0	51.0
REMOTE CONTROL UNIT-PLSS	B1001.	115	2	A12	10.2	272.0	.0	-18.0
BRACKET, CAMERA MOUNT	B1001.1	115	1	F7F	.6	238.0	38.0	31.6
UTILITY TOWEL ASSEMBLY, LM	B1008.	115	2	F10	.6	242.8	-35.4	47.2
DEFECTION COLLECTION DEVICE	B1009.	115	1	F1F	.2	235.5	-37.6	46.6
BAG ASSY, LEC + W.T.	B1020.1	115	1	F7N	.2	238.0	38.0	53.1
CONVEYOR ASSY, LUNAR EQUIP.	B1020.2	115	1	F7N	1.2	238.0	38.0	53.1
BAG, DEPLOYMENT, LEC	B1020.3	115	1	F7N	.1	238.0	38.0	53.1
PLSS/EVCS ASSY	B1024.	114	1	F9	86.3	219.7	.0	44.7
PLSS/EVCS ASSY	B1025.	114	1	A1B	86.3	262.8	-20.8	15.4
BAG, JETTISON STOWAGE	B1027.	115	3	A1G	2.7	257.5	-20.0	-18.0
DISPENSER, TISSUE	B1033.	116	1	F1E	1.4	237.9	-33.6	55.0
LCL ADAPTER	B1036.	116	2	F7E	.4	238.0	38.0	32.7
JACKET ASSY, ICG	B1039.1	116	2	A1C(ICG ASSY)	3.6	240.5	-15.3	13.3
TROUSER ASSY, ICG	B1039.2	116	2	A1C(ICG ASSY)	3.6	240.5	-15.3	13.3
BOOT, RIGHT, ICG	B1039.3	116	2	A1C(ICG ASSY)	.8	240.5	-15.3	13.3
BOOT, LEFT, ICG	B1039.4	116	2	A1C(ICG ASSY)	.8	240.5	-15.3	13.3
TOWELS,LM UTILITY(RED)	B1043.	115	2	F1G	.2	228.0	-40.2	43.2

Table 3.5-9.3 (Continued)

MISSION J-1 TRANSFERRED CREW AND EQUIPMENT STOWAGE LIST								
ITEMS OFFLOADED FROM ASC. STAGE PRIOR TO LUNAR LIFT-OFF (11)							LM COORDINATES	
DESCRIPTION	STOW. ITEM	REF	NO.	STOWAGE LOCATION	WEIGHT	X-C.G.	Y-C.G.	Z-C.G.
TOWELS, LM UTILITY (BLUE)	81044.	115	2	FIG	.2	228.0	-40.2	43.2
DEVICE, IN-SUIT DRINKING	81048.	114	2	VOLUME CENTROID AS	1.6	254.0	.0	.0
BUDDY SLSS ASSY SPLY (BUD. SYS.)	81052.	116	1	A5	10.9	224.3	-1.5	29.3
FOOD ASSY, LM	C1002.	165	1	A9 (APROX.)	3.3	278.0	.0	-20.0
WIPES, WET, FACIAL	C1005.0	115	5	F1A	NEGL	244.5	-36.6	31.4
TETHER, EVA RETRACTABLE	A1029.	115	1	F9	.2	219.7	.0	44.7
TETHER, EVA RETRACTABLE	A1029.	115	1	F9	.2	219.7	.0	44.7
CANISTER, ECS LIQH	03008.	115	1	A1D	9.2	270.3	-15.0	19.0
URINE COLLECTION ASSY.	03009.	115	1	F1F	.3	235.5	-37.6	46.6
BAG, EMESIS	03011.	115	1	F1F	.2	235.5	-37.6	46.6
STRAP, ECS LIQH CANNISTER	03024.	115	1	A1O	.1	250.0	8.8	-11.8
URINE RECEPTACLE SYSTEM	03039.	115	1	F1C	.6	242.5	-35.6	38.5
FECAL COLLECTION RECPT. ASSY	03040.	115	1	A4	1.2	244.1	-3.5	13.5
FECAL COLLECTION CONTAINER	03041.	115	9	F1F	2.7	235.5	-37.6	46.6
HAMMOCK ASSY.	03048.	115	1	FIG	4.1	228.0	-40.2	43.2
HAMMOCK ASSY.	03050.	115	1	FIG	3.9	228.0	-40.2	43.2
SCALE, SAMPLE	G4031.	115	1	F7K	.5	238.0	38.0	42.7
BOOTS, LUNAR PAIR	81018.	115	1	A1L	4.9	273.7	-20.0	-8.5
BOOTS, LUNAR PAIR	81018.	115	1	A1K	4.9	281.0	-20.0	-8.5
ADAPTER, SRC/OPS	03004.	115	1	A1F	2.4	257.4	-20.7	-6.0
ADAPTER, SRC/OPS	03004.	115	1	VOLUME CENTROID AS	2.4	254.0	.0	.0
CONTAINER, BUDDY SLSS ASSY, STOW	03059.	111	1	A5	3.1	224.3	-1.5	29.3
ARM RESTS	T80	346	2	LH CREW STATION-	2.2	260.0	-22.0	45.0
ARM RESTS	T80	346	2	RH CREW STATION-	2.2	260.0	22.0	45.0
LEFT AT LUNAR SITE					279.50	245.05	-9.24	26.05

Amendment 94
12/10/70

Table 3.5-9.3 (Continued)

MISSION J-1 TRANSFERRED CREW AND EQUIPMENT STORAGE LIST								
ITEMS UNLOADED INTO ASC. STAGE PRIOR TO LUNAR LIFT-OFF (12)								
DESCRIPTION	STOW. ITEM	REF	NO.	STOWAGE LOCATION	WEIGHT	LM COORDINATES		
						X-C.G.	Y-C.G.	Z-C.G.
CONTAINER SAMPLE RTN NO.1 (LD)	G4003	115	1	A1E	65.0	265.9	-20.7	-6.0
CONTAINER SAMPLE RTN NJ.2 (LD)	G4004	115	1	A1F	65.0	257.4	-20.7	-6.0
CONTR.CONTINGNCY,LUN.SAM.RTN.	G4016.	115	1	A1G	2.6	257.5	-20.0	-18.0
CONTAINER SAMPLE RTN NO.3 (LD)	G4020.	111	1	VOLUME CENTROID AS	65.0	254.0	.0	.0
BAG,SAMPLE RETURN	03060.	111	1	ON PLUS 227 BULKHEAD	35.0	260.0	-37.0	28.0
PENETROMETER,RECORDING	G4049.	111	1	VOLUME CENTROID AS	2.0	254.0	.0	.0
BAG,EXTRA SAMPLE COLLECTION	G4048.	111	3	A1D	35.0	270.3	-15.0	19.0
ONLOAD AT LUN.SITE					269.60	260.62	-16.93	3.03

Table 3.5-9.3 (Continued)

MISSION J-1 TRANSFERRED CREW AND EQUIPMENT STOWAGE LIST								
ITEMS REARRANGED IN LM PRIOR TO LUNAR LIFT-OFF (13)								LM COORDINATES
DESCRIPTION	STOW. ITEM	REF	NO.	STOWAGE LOCATION	WEIGHT	X-C.G.	Y-C.G.	Z-C.G.
OXYGEN PURGE SYSTEM	01012.	115	1	A1E	35.9	265.9	-20.7	-6.0
BAG, HELMET STOWAGE	01050.	115	1	F8	1.4	221.0	18.0	51.0
BAG, HELMET STOWAGE	01050.	115	1	F10	1.4	221.0	-18.0	51.0
LUNAR EXTRAVEHICULAR VISOR	01014.	115	1	F8	4.9	221.0	18.0	51.0
LUNAR EXTRAVEHICULAR VISOR	01014.	115	1	F10	4.9	221.0	-18.0	51.0
GLOVES, EV-PAIR	01015.	115	1	F8	3.0	221.0	18.0	51.0
GLOVES, EV-PAIR	01015.	115	1	F10	3.0	221.0	-18.0	51.0
KIT, EMU MAINTENANCE	01016.	115	1	F10	.5	221.0	-18.0	51.0
PURGE VALVE ASSY.	01017.	115	1	A1L	.6	273.7	-20.0	-8.5
PURGE VALVE ASSY.	01017.	115	1	A1K	.6	281.0	-20.0	-8.5
STRAPS, ATTACH, PLSS, LOWER(LH)	01021.	115	1	F9	.2	219.7	.0	44.7
STRAPS, ATTACH, PLSS, LOWER(LH)	01021.	115	1	A1B	.2	262.8	-20.8	15.4
GARMENT, LIQUID COOLING	01030.	111	1	A1C	6.9	240.5	-18.0	13.3
GARMENT, LIQUID COOLING	01030.	111	1	A1C	6.9	240.5	-18.0	13.3
BAG, TEMPORARY STOWAGE	03031.	111	1	F6B	.9	270.3	.0	52.8
STRAPS, ATTACH, PLSS, LOWER(RH)	01022.	115	1	F9	.3	219.7	.0	44.7
STRAPS, ATTACH, PLSS, LOWER(RH)	01022.	115	1	A1B	.3	262.8	-20.8	15.4
MAGAZINE, L.S. HASSELBLAD	A0108.1	116	1	F7C	1.4	238.0	38.0	41.0
LM EQUIP.RELOC.2					73.30	248.79	-13.39	14.56

Table 3.5-9.3 (Continued)

MISSION J-1 TRANSFERRED CREW AND EQUIPMENT STORAGE LIST								
ITEMS REARRANGED IN LM PRIOR TO LUNAR LIFT-OFF (14)								
DESCRIPTION	STOW. ITEM	REF	NO.	STOWAGE LOCATION	WEIGHT	LM COORDINATES		
						X-C.G.	Y-C.G.	Z-C.G.
OXYGEN PURGE SYSTEM	81012.	115	1	F9	35.9	219.7	.0	44.7
BAG, HELMET STOWAGE	81058.	115	1	A3	1.4	280.0	.0	-10.0
BAG, HELMET STOWAGE	81058.	115	1	A3	1.4	280.0	.0	-10.0
LUNAR EXTRAVEHICULAR VISOR	81014.	115	1	A3	4.9	280.0	.0	-10.0
LUNAR EXTRAVEHICULAR VISOR	81014.	115	1	A3	4.9	280.0	.0	-10.0
GLOVES, EV-PAIR	81015.	115	1	HSB(ON ASC.ENG COVR)	3.0	260.0	-5.5	-1.5
GLOVES, EV-PAIR	81015.	115	1	HSB(ON ASC.ENG COVR)	3.0	260.0	-5.5	-1.5
KIT, EMU MAINTENANCE	81016.	115	1	A3	.5	280.0	.0	-10.0
PURGE VALVE ASSY.	81017.	115	1	F7P	.6	238.0	38.0	53.4
PURGE VALVE ASSY.	81017.	115	1	F7P	.6	238.0	38.0	53.4
STRAPS, ATTACH, PLSS, LOWER(LH)	81021.	115	1	F7P	.2	238.0	38.0	53.4
STRAPS, ATTACH, PLSS, LOWER(LH)	81021.	115	1	F7P	.2	238.0	38.0	53.4
GARMENT, LIQUID COOLING	81030.	111	1	ON CREW(RH CREW STA)	6.9	260.0	22.0	45.0
GARMENT, LIQUID COOLING	81030.	111	1	ON CREW(LH CREW STA)	6.9	260.0	-22.0	45.0
BAG, TEMPORARY STOWAGE	03031.	111	1	A1D	.9	270.3	-15.0	19.0
STRAPS, ATTACH, PLSS, LOWER(RH)	81022.	115	1	F7P	.3	238.0	38.0	53.4
STRAPS, ATTACH, PLSS, LOWER(RH)	81022.	115	1	F7P	.3	238.0	38.0	53.4
MAGAZINE, L.S. HASSELBLAD	A0108.1	116	1	F7D	1.4	238.0	38.0	38.4
LM EQUIP.RELOC.2					73.30	242.88	1.23	31.02

Table 3.5-9.3 (Continued)

MISSION J-1 TRANSFERRED CREW AND EQUIPMENT STOWAGE LIST								
ITEMS TRANSFERRED FROM ASC. STAGE INTO CM PRIOR TO ASC. STAGE JETTISON (15)								LM COORDINATES
DESCRIPTION	STOW. ITEM	REF	NO.	STOWAGE LOCATION	WEIGHT	X-C.G.	Y-C.G.	Z-C.G.
CREW-COMMANDER (CDR)	TBD	227	1	LH CREW STATION-	167.0	260.0	-22.0	45.0
CREW-LM PILOT (LMP)	TBD	227	1	RH CREW STATION-	173.0	260.0	22.0	45.0
LM LUNAR SURFACE CHECKLIST	A0114.10	114	1	LM XFR DATA CARD KIT	1.0	280.8	-20.0	14.0
LM SYSTEMS ACTIVATION CHK.LST.	A0114.12	114	1	LM XFR DATA CARD KIT	.5	280.8	-20.0	14.0
LM LUNAR SURFACE MAPS	A0114.13	114	1	LM XFR DATA CARD KIT	1.5	280.8	-20.0	14.0
LM TIMELINE BOOK	A0114.14	114	1	LM XFR DATA CARD KIT	.5	280.8	-20.0	14.0
LM XFR DATA CARD KIT	A0114.18	114	1	LM XFR DATA CARD KIT	.6	280.8	-20.0	14.0
LM DATA CARD BOOK	A0114.19	114	1	LM XFR DATA CARD KIT	.3	280.8	-20.0	14.0
LM RNDZ/ABORT BOOK	A0114.22	114	1	LM XFR DATA CARD KIT	.3	280.8	-20.0	14.0
MONOCULAR 10x40	A0130.	116	1	F7B	.7	238.0	38.0	49.8
SUBSYSTEM,FECAL CONTAINMENT	B0113.	111	1	ON CREW(LM CREW STA)	.3	260.0	-22.0	45.0
SUBSYSTEM,FECAL CONTAINMENT	B0113.	111	1	ON CREW(RH CREW STA)	.3	260.0	22.0	45.0
ADAPTER,CWG ELECTRICAL-CDR	B0135.	111	1	F1E	.4	237.9	-33.6	55.0
ADAPTER,CWG ELECTRICAL-LMP	B0135.	111	1	F1E	.4	237.9	-33.6	55.0
DOSIMETER, PASSIVE RADIATION	D0101.	111	1	F7L	NEGL	236.0	36.0	48.0
HEADSET, LIGHT WEIGHT	E0104.	111	1	F1B	.4	235.5	-35.5	38.5
HEADSET, LIGHT WEIGHT	E0104.	111	1	F1B	.4	235.5	-35.5	38.5
SUNGLASSES	A0200.	117	1	ON CREW(LM CREW STA)	.1	260.0	-22.0	45.0
SUNGLASSES	A0200.	117	1	ON CREW(RH CREW STA)	.1	260.0	22.0	45.0
POUCH,SUNGLASSES	A0201.	117	1	ON CREW(LM CREW STA)	NEGL	260.0	-22.0	45.0
POUCH,SUNGLASSES	A0201.	117	1	ON CREW(RH CREW STA)	NEGL	260.0	22.0	45.0
CHRONOGRAPH * -002	A0202.	117	1	ON CREW(LM CREW STA)	.1	260.0	-22.0	45.0
CHRONOGRAPH * -002	A0202.	117	1	ON CREW(RH CREW STA)	.1	260.0	22.0	45.0
WATCHBAND	A0203.	117	1	ON CREW(LM CREW STA)	NEGL	260.0	-22.0	45.0
WATCHBAND	A0203.	117	1	ON CREW(RH CREW STA)	NEGL	260.0	22.0	45.0
PENS,DATA RECORDING	A0204.	117	1	ON CREW(LH CREW STA)	.1	260.0	-22.0	45.0
PENS,DATA RECORDING	A0204.	117	1	ON CREW(RH CREW STA)	.1	260.0	22.0	45.0
PEN, MARKER	A0205.	117	1	ON CREW(LM CREW STA)	NEGL	260.0	-22.0	45.0
PEN, MARKER	A0205.	117	1	ON CREW(RH CREW STA)	NEGL	260.0	22.0	45.0
PENCIL	A0206.	117	1	ON CREW(LH CREW STA)	.1	260.0	-22.0	45.0
PENCIL	A0206.	117	1	ON CREW(RH CREW STA)	.1	260.0	22.0	45.0

Table 3.5-9.3 (Continued)

MISSION J-1 TRANSFERRED CREW AND EQUIPMENT STOWAGE LIST								
ITEMS TRANSFERRED FROM ASC. STAGE INTO CM PRIOR TO ASC. STAGE JETTISON (15)								
LM COORDINATES								
DESCRIPTION	STOW. ITEM	REF	NO.	STOWAGE LOCATION	WEIGHT	X-C.G.	Y-C.G.	Z-C.G.
ASSY, BIOINSTRUMENTATION	80203.	111	1	ON CREW(LH CREW STA)	1.1	260.0	-22.0	45.0
ASSY, BIOINSTRUMENTATION	80203.	111	1	ON CREW(RH CREW STA)	1.1	260.0	22.0	45.0
SCISSORS	80204.	111	1	ON CREW(LH CREW STA)	.5	260.0	-22.0	45.0
UCTA	80205.	111	1	ON CREW(RH CREW STA)	.5	260.0	22.0	45.0
UCTA	80205.	111	1	ON CREW(LH CREW STA)	.5	260.0	-22.0	45.0
PENLIGHTS	80206.	117	1	ON CREW(RH CREW STA)	.3	260.0	22.0	45.0
PENLIGHTS	80206.	117	1	ON CREW(LH CREW STA)	.3	260.0	-22.0	45.0
ASSY. BIOBELT	80207.	117	1	ON CREW(RH CREW STA)	.2	260.0	22.0	45.0
ASSY. BIOBELT	80207.	117	1	ON CREW(LH CREW STA)	.2	260.0	-22.0	45.0
ITLSA EV	80211.	111	1	ON CREW(RH CREW STA)	45.0	260.0	22.0	45.0
ITLSA EV	80211.	111	1	ON CREW(LH CREW STA)	45.0	260.0	-22.0	45.0
GLOVES, IV PAIR	80213.	111	1	ON CREW(RH CREW STA)	2.1	260.0	22.0	45.0
GLOVES, IV PAIR	80213.	111	1	ON CREW(LH CREW STA)	2.1	260.0	-22.0	45.0
HELMET ASSY, PRESSURE	80214.	111	1	ON CREW(RH CREW STA)	2.6	260.0	22.0	45.0
HELMET ASSY, PRESSURE	80214.	111	1	ON CREW(LH CREW STA)	2.6	260.0	-22.0	45.0
HARNES, ELEC.-SUIT	80215.	111	1	ON CREW(RH CREW STA)	.5	260.0	22.0	45.0
HARNES, ELEC.-SUIT	80215.	111	1	ON CREW(LH CREW STA)	.5	260.0	-22.0	45.0
HARNES, BIOINSTRUMENTATION	80216.	111	1	ON CREW(RH CREW STA)	.3	260.0	22.0	45.0
HARNES, BIOINSTRUMENTATION	80216.	111	1	ON CREW(LH CREW STA)	.3	260.0	-22.0	45.0
COMMUNICATION CARRIER	80217.	111	1	ON CREW(RH CREW STA)	1.6	260.0	22.0	45.0
COMMUNICATION CARRIER	80217.	111	1	ON CREW(LH CREW STA)	1.6	260.0	-22.0	45.0
POCKET, CHECKLIST + SCISSORS	80218.	111	1	ON CREW(RH CREW STA)	.2	260.0	22.0	45.0
POCKET, CHECKLIST + SCISSORS	80218.	111	1	ON CREW(LH CREW STA)	.2	260.0	-22.0	45.0
POCKET, CHECKLIST	80219.	111	1	ON CREW(RH CREW STA)	.2	260.0	22.0	45.0
POCKET, CHECKLIST	80219.	111	1	ON CREW(LH CREW STA)	.2	260.0	-22.0	45.0
DOSIMETER, PERSONAL	00200.	117	1	ON CREW(RH CREW STA)	.4	260.0	22.0	45.0
DOSIMETER, PERSONAL	00200.	117	1	ON CREW(LH CREW STA)	.4	260.0	-22.0	45.0
DOSIMETER, PASSIVE	00201.	117	3	ON CREW(RH CREW STA)	NEGL	260.0	22.0	45.0
DOSIMETER, PASSIVE	00201.	117	3	ON CREW(LH CREW STA)	NEGL	260.0	-22.0	45.0
EARPIECE, MOULDED (COM.CARRIER)	E0200.1	111	1	ON CREW(RH CREW STA)	NEGL	260.0	22.0	45.0
EARPIECE, MOULDER (COM.CARRIER)	E0200.1	111	1	ON CREW(LH CREW STA)	NEGL	260.0	-22.0	45.0

Table 3.5-9.3 (Continued)

MISSION J-1 TRANSFERRED CREW AND EQUIPMENT STOWAGE LIST								
ITEMS TRANSFERRED FROM ASC. STAGE INTO CM PRIOR TO ASC. STAGE JETTISON (15)								
LM COORDINATES								
DESCRIPTION	STOW. ITEM	REF	NO.	STOWAGE LOCATION	WEIGHT	X-C.G.	Y-C.G.	Z-C.G.
EARTUBE (COM.CARRIER)	E0200.2	111	2	ON CREW(RH CREW STA)	NEGL	260.0	22.0	45.0
EARTUBE (COM.CARRIER)	E0200.2	111	2	ON CREW(LM CREW STA)	NEGL	260.0	-22.0	45.0
BAG,XFER, 16MM MAG (6)	06397.	111	1	F7L	.3	236.0	36.0	48.0
BAG,XFER, 70MM MAG (4)	06398.	111	1	F70	.3	238.0	38.0	38.4
KIT, PILOTS PREFERENCE	A1007.	111	2	A1H	1.0	265.9	-20.0	-18.0
KIT, PILOTS PREFERENCE	A1007.	111	1	A1H	.5	265.9	-20.0	-18.0
OXYGEN PURGE SYSTEM	81012.	115	1	F9	35.9	219.7	.0	44.7
BAG, HELMET STOWAGE	81058.	115	1	A3	1.4	280.0	.0	-10.0
BAG, HELMET STOWAGE	81058.	115	1	A3	1.4	280.0	.0	-10.0
LUNAR EXTRAVEHICULAR VISOR	81014.	115	1	A3	4.9	280.0	.0	-10.0
LUNAR EXTRAVEHICULAR VISOR	81014.	115	1	A3	4.9	280.0	.0	-10.0
GLOVES,EV-PAIR	81015.	115	1	HSB(ON ASC.ENG COVR)	3.0	260.0	-5.5	-1.5
GLOVES,EV-PAIR	81015.	115	1	HSB(ON ASC.ENG COVR)	3.0	260.0	-5.5	-1.5
KIT,EMU MAINTENANCE	81016.	115	1	A3	.5	280.0	.0	-10.0
PURGE VALVE ASSY.	81017.	115	1	F7P	.6	238.0	38.0	53.4
GARMENT,LIQUID COOLING	81030.	111	1	ON CREW(RH CREW STA)	6.9	260.0	22.0	45.0
GARMENT,LIQUID COOLING	81030.	111	1	ON CREW(LM CREW STA)	6.9	260.0	-22.0	45.0
FLAG KIT,STANDARO	N1002.	166	1	A1H	.9	265.9	-20.0	-18.0
CONTAINER SAMPLE RTN NO.1 (LD)	G4003	115	1	A1E	65.0	265.9	-20.7	-6.0
CONTAINER SAMPLE RTN NO.2 (LD)	G4004	115	1	A1F	65.0	257.4	-20.7	-6.0
CONTR.CONTINGNCY,LUN.SAM.RTN.	G4016.	115	1	A1G	2.6	257.5	-20.0	-18.0
CONTAINER SAMPLE RTN NO.3 (LD)	G4020.	111	1	VOLUME CENTROID AS	65.0	254.0	.0	.0
DSEA	03005.	115	1	VOLUME CENTROID AS	2.3	254.0	.0	.0
TETHER, WAIST EVA	81020.6	115	1	F7N	.5	238.0	38.0	53.1
TETHER, WAIST EVA	81020.7	115	1	F7N	.5	238.0	38.0	53.1
INTERIM STOWAGE ASSY.	03007.	111	1	A10	7.6	270.3	-15.0	19.0
BAG,SAMPLE RETURN	03060.	111	1	ON PLUS 227 BULKHEAD	35.0	260.0	-37.0	28.0
MAGAZINE, L.S. HASSELBLAD	A0108.1	116	3	F70	4.2	238.0	38.0	38.4
MAGAZINE, L.S. HASSELBLAD	A0108.1	116	1	F70	1.4	238.0	38.0	38.4
MAGAZINE, L.S. HASSELBLAD	A0108.1	116	3	F7D	4.2	238.0	38.0	38.4
PENETROMETER,RECORDING	G4049.	111	1	VOLUME CENTROID AS	2.0	254.0	.0	.0

Amendment 94
12/10/70

Table 3.5-9.3 (Continued)

MISSION J-1 TRANSFERRED CREW AND EQUIPMENT STOWAGE LIST								
ITEMS TRANSFERRED FROM ASC. STAGE INTO CM PRIOR TO ASC. STAGE JETTISON (15)								
LM COORDINATES								
DESCRIPTION	STOW. ITEM	REF	NO.	STOWAGE LOCATION	WEIGHT	X-C.G.	Y-C.G.	Z-C.G.
BAG, EXTRA SAMPLE COLLECTION	G4048.	111	3	A1D	35.0	270.3	-15.0	19.0
MAGAZINE, 16MM DATA ACQ.	A0101.1	116	5	F7L	5.0	236.0	36.0	48.0
MAGAZINE, 16MM DATA ACQ.	A0101.1	116	2	ISA (A10)	2.0	270.3	-15.0	19.0
MAGAZINE, 16MM DATA ACQ.	A0101.1	116	1	F5	1.0	286.0	17.8	66.6
BAG, TRANSFER-16MM MAG. (2)	06432.	111	1	ISA (A1D)	.1	270.3	-15.0	19.0
BAG, TRANSFER-70MM MAG (3)	06434.	111	1	F7P	.5	238.0	38.0	53.4
2 CREW+EQUIP, LM-CM					830.21	258.50	-4.96	29.36

Table 3.5-9.3 (Continued)

MISSION J-1 TRANSFERRED CREW AND EQUIPMENT STOWAGE LIST								
ITEMS TRANSFERRED FROM ASC. STAGE INTO CM PRIOR TO ASC. STAGE JETTISON (16)								
APOLLO COORDINATES								
DESCRIPTION	STOW. ITEM	REF	NO.	STOWAGE LOCATION	WEIGHT	X-C.G.	Y-C.G.	Z-C.G.
CREW-COMMANDER (CDR)	T80	227	1	ON COUCH(CTR CRW STA)	167.0	1043.0	.0	-10.4
CREW-LM PILOT (LMP)	T80	227	1	ON COUCH(RH CREW STA)	173.0	1043.0	24.5	-10.4
LM LUNAR SURFACE CHECKLIST	A0114.10	114	1	IN FDF (R3)	1.0	1072.0	26.0	9.0
LM SYSTEMS ACTIVATION CHK.LST.	A0114.12	114	1	IN FDF (R3)	.5	1072.0	26.0	9.0
LM LUNAR SURFACE MAPS	A0114.13	114	1	IN FDF (R3)	1.5	1072.0	26.0	9.0
LM TIMELINE BOOK	A0114.14	114	1	IN FDF (R3)	.5	1072.0	26.0	9.0
LM XFR DATA CARD KIT	A0114.18	114	1	IN FDF (R3)	.6	1072.0	26.0	9.0
LM DATA CARD BOOK	A0114.19	114	1	IN FDF (R3)	.3	1072.0	26.0	9.0
LM RNDZ/ABORT BOOK	A0114.22	114	1	IN FDF (R3)	.3	1072.0	26.0	9.0
MONOCULAR 10X40	A0130.	116	1	AREA U4	.7	1038.0	39.0	-43.0
SUBSYSTEM,FECAL CONTAINMENT	B0113.	111	1	ON CREW-LMP(RH STA)	.3	1043.0	24.5	-10.4
SUBSYSTEM,FECAL CONTAINMENT	B0113.	111	1	ON CREW-CDR(CTR.STA)	.3	1043.0	.0	-10.4
ADAPTER,CWG ELECTRICAL-CDR	B0135.	111	1	ON CREW-COR(CTR.STA)	.4	1043.0	.0	-10.4
ADAPTER,CWG ELECTRICAL-LMP	B0135.	111	1	ON CREW-LMP(RH STA)	.4	1043.0	24.5	-10.4
DOSIMETER, PASSIVE RADIATION	D0101.	111	1	IN XFR BAG (R13)	NEGL	1024.0	45.0	-26.0
HEADSET, LIGHT WEIGHT	E0104.	111	1	AREA A8	.4	1012.0	22.0	-23.0
HEADSET, LIGHT WEIGHT	E0104.	111	1	AREA A8	.4	1012.0	22.0	-23.0
SUNGLASSES	A0200.	117	1	ON CREW-CDR(CTR.STA)	.1	1043.0	.0	-10.4
SUNGLASSES	A0200.	117	1	ON CREW-LMP(RH STA)	.1	1043.0	24.5	-10.4
POUCH,SUNGLASSES	A0201.	117	1	ON CREW-CDR(CTR.STA)	NEGL	1043.0	.0	-10.4
POUCH,SUNGLASSES	A0201.	117	1	ON CREW-LMP(RH STA)	NEGL	1043.0	24.5	-10.4
CHRONOGRAPH * -002	A0202.	117	1	ON CREW-CDR(CTR.STA)	.1	1043.0	.0	-10.4
CHRONOGRAPH * -002	A0202.	117	1	ON CREW-LMP(RH STA)	.1	1043.0	24.5	-10.4
WATCHBAND	A0203.	117	1	ON CREW-CDR(CTR.STA)	NEGL	1043.0	.0	-10.4
WATCHBAND	A0203.	117	1	ON CREW-LMP(RH STA)	NEGL	1043.0	24.5	-10.4
PENS,DATA RECORDING	A0204.	117	1	ON CREW-CDR(CTR.STA)	.1	1043.0	.0	-10.4
PENS,DATA RECORDING	A0204.	117	1	ON CREW-LMP(RH STA)	.1	1043.0	24.5	-10.4
PEN, MARKER	A0205.	117	1	ON CREW-CDR(CTR.STA)	NEGL	1043.0	.0	-10.4
PEN, MARKER	A0205.	117	1	ON CREW-LMP(RH STA)	NEGL	1043.0	24.5	-10.4
PENCIL	A0206.	117	1	ON CREW-CDR(CTR.STA)	.1	1043.0	.0	-10.4
PENCIL	A0206.	117	1	ON CREW-LMP(RH STA)	.1	1043.0	24.5	-10.4

Table 3.5-9.3 (Continued)

MISSION J-1 TRANSFERRED CREW AND EQUIPMENT STORAGE LIST								
ITEMS TRANSFERRED FROM ASC. STAGE INTO CM PRIOR TO ASC. STAGE JETTISON (16)								
APOLLO COORDINATES								
DESCRIPTION	STOW. ITEM	REF	NO.	STOWAGE LOCATION	WEIGHT	X-C.G.	Y-C.G.	Z-C.G.
ASSY, BIOINSTRUMENTATION	B0203.	111	1	ON CREW-CDR(CTR.STA)	1.1	1043.0	.0	-10.4
ASSY, BIOINSTRUMENTATION	B0203.	111	1	ON CREW-LMP(RH STA)	1.1	1043.0	24.5	-10.4
SCISSORS	B0204.	111	1	ON CREW-CDR(CTR.STA)	.5	1043.0	.0	-10.4
UCTA	B0205.	111	1	ON CREW-LMP(RH STA)	.5	1043.0	24.5	-10.4
UCTA	B0205.	111	1	ON CREW-CDR(CTR.STA)	.5	1043.0	.0	-10.4
PENLIGHTS	B0206.	117	1	ON CREW-LMP(RH STA)	.3	1043.0	24.5	-10.4
PENLIGHTS	B0206.	117	1	ON CREW-CDR(CTR.STA)	.3	1043.0	.0	-10.4
ASSY. BIOBELT	B0207.	117	1	ON CREW-LMP(RH STA)	.2	1043.0	24.5	-10.4
ASSY. BIOBELT	B0207.	117	1	ON CREW-CDR(CTR.STA)	.2	1043.0	.0	-10.4
ITLSA EV	B0211.	111	1	ON CREW-LMP(RH STA)	45.0	1043.0	24.5	-10.4
ITLSA EV	B0211.	111	1	ON CREW-CDR(CTR.STA)	45.0	1043.0	.0	-10.4
GLOVES, IV PAIR	B0213.	111	1	ON CREW-LMP(RH STA)	2.1	1043.0	24.5	-10.4
GLOVES, IV PAIR	B0213.	111	1	ON CREW-CDR(CTR.STA)	2.1	1043.0	.0	-10.4
HELMET ASSY, PRESSURE	B0214.	111	1	ON CREW-LMP(RH STA)	2.6	1043.0	24.5	-10.4
HELMET ASSY, PRESSURE	B0214.	111	1	ON CREW-CDR(CTR.STA)	2.6	1043.0	.0	-10.4
HARNES, ELEC.-SUIT	B0215.	111	1	ON CREW-CDR(CTR.STA)	.5	1043.0	.0	-10.4
HARNES, ELEC.-SUIT	B0215.	111	1	ON CREW-LMP(RH STA)	.5	1043.0	24.5	-10.4
HARNES, BIOINSTRUMENTATION	B0216.	111	1	ON CREW-CDR(CTR.STA)	.3	1043.0	.0	-10.4
HARNES, BIOINSTRUMENTATION	B0216.	111	1	ON CREW-LMP(RH STA)	.3	1043.0	24.5	-10.4
COMMUNICATION CARRIER	B0217.	111	1	ON CREW-LMP(RH STA)	1.6	1043.0	24.5	-10.4
COMMUNICATION CARRIER	B0217.	111	1	ON CREW-CDR(CTR.STA)	1.6	1043.0	.0	-10.4
POCKET, CHECKLIST + SCISSORS	B0218.	111	1	ON CREW-LMP(RH STA)	.2	1043.0	24.5	-10.4
POCKET, CHECKLIST + SCISSORS	B0218.	111	1	ON CREW-CDR(CTR.STA)	.2	1043.0	.0	-10.4
POCKET, CHECKLIST	B0219.	111	1	ON CREW-LMP(RH STA)	.2	1043.0	24.5	-10.4
POCKET, CHECKLIST	B0219.	111	1	ON CREW-CDR(CTR.STA)	.2	1043.0	.0	-10.4
DOSIMETER, PERSONAL	D0200.	117	1	ON CREW-CDR(CTR.STA)	.4	1043.0	.0	-10.4
DOSIMETER, PERSONAL	D0200.	117	1	ON CREW-LMP(RH STA)	.4	1043.0	24.5	-10.4
DOSIMETER, PASSIVE	D0201.	117	3	ON CREW-LMP(RH STA)	NEGL	1043.0	24.5	-10.4
DOSIMETER, PASSIVE	D0201.	117	3	ON CREW-CDR(CTR.STA)	NEGL	1043.0	.0	-10.4
EARPIECE, MOULDED (COM.CARRIER)	E0200.1	111	1	ON CREW-CDR(CTR.STA)	NEGL	1043.0	.0	-10.4
EARPIECE, MOULDER (COM.CARRIER)	E0200.1	111	1	ON CREW-LMP(RH STA)	NEGL	1043.0	24.5	-10.4

Table 3.5-9.3 (Continued)

MISSION J-1 TRANSFERRED CREW AND EQUIPMENT STOWAGE LIST								
ITEMS TRANSFERRED FROM ASC. STAGE INTO CM PRIOR TO ASC. STAGE JETTISON (16)								
APOLLO COORDINATES								
DESCRIPTION	STOW. ITEM	REF	NO.	STOWAGE LOCATION	WEIGHT	X-C.G.	Y-C.G.	Z-C.G.
EARTUBE (COM.CARRIER)	E0200.2	111	2	ON CREW-COR(CTR.STA)	NEGL	1043.0	.0	-10.4
EARTUBE (COM.CARRIER)	E0200.2	111	2	ON CREW-LM(1RH STA)	NEGL	1043.0	24.5	-10.4
BAG,XFER, 16MM MAG (6)	06397.	111	1	AREA R13	.3	1024.0	45.0	-26.0
BAG,XFER, 70MM MAG (4)	06398.	111	1	AREA R13	.3	1024.0	45.0	-26.0
KIT, PILOTS PREFERENCE	A1007.	111	2	AREA A8	1.0	1012.0	22.0	-23.0
KIT, PILOTS PREFERENCE	A1007.	111	1	AREA A8	.5	1012.0	22.0	-23.0
OXYGEN PURGE SYSTEM	81012.	115	1	AREA A7	35.9	1010.0	23.0	8.0
BAG, HELMET STOWAGE	81058.	115	1	IN CM PGA CONTAINER	1.4	1015.0	.0	-19.9
BAG, HELMET STOWAGE	81058.	115	1	IN CM PGA CONTAINER	1.4	1015.0	.0	-19.9
LUNAR EXTRAVEHICULAR VISOR	81014.	115	1	IN CM PGA CONTAINER	4.9	1015.0	.0	-19.9
LUNAR EXTRAVEHICULAR VISOR	81014.	115	1	IN CM PGA CONTAINER	4.9	1015.0	.0	-19.9
GLOVES,EV-PAIR	81015.	115	1	IN CM PGA CONTAINER	3.0	1015.0	.0	-19.9
GLOVES,EV-PAIR	81015.	115	1	IN CM PGA CONTAINER	3.0	1015.0	.0	-19.9
KIT,EMU MAINTENANCE	81016.	115	1	IN CM PGA CONTAINER	.5	1015.0	.0	-19.9
PURGE VALVE ASSY.	81017.	115	1	AREA A7	.6	1010.0	23.0	8.0
GARMENT,LIQUID COOLING	81030.	111	1	ON CREW-LM(1RH STA)	6.9	1043.0	24.5	-10.4
GARMENT,LIQUID COOLING	81030.	111	1	ON CREW-COR(CTR.STA)	6.9	1043.0	.0	-10.4
FLAG KIT,STANDARD	N1002.	166	1	AREA A8	.9	1012.0	22.0	-23.0
CONTAINER SAMPLE RTN NO.1 (LD)	G4003	115	1	AREA B5	65.0	1031.0	-8.0	39.0
CONTAINER SAMPLE RTN NO.2 (LD)	G4004	115	1	AREA B6	65.0	1031.0	13.0	39.0
CONTR.CONTINGNCY,LUN.SAM.RTN.	G4016.	115	1	AREA R13	2.6	1024.0	45.0	-26.0
CONTAINER SAMPLE RTN NO.3 (LD)	G4020.	111	1	AREA A9	65.0	1013.0	.0	16.0
OSEA	03005.	115	1	AREA A8	2.3	1012.0	22.0	-23.0
TETHER, WAIST EVA	81020.6	115	1	AREA A7	.5	1010.0	23.0	8.0
TETHER, WAIST EVA	81020.7	115	1	AREA A7	.5	1010.0	23.0	8.0
INTERIM STOWAGE ASSY.	03007.	111	1	AREA A2	7.6	1010.0	-23.0	8.0
BAG,SAMPLE RETURN	03060.	111	1	AREA A7	35.0	1010.0	23.0	8.0
MAGAZINE, L.S. HASSELBLAD	A0108.1	116	3	AREA R13	4.2	1024.0	45.0	-26.0
MAGAZINE, L.S. HASSELBLAD	A0108.1	116	1	AREA R13	1.4	1024.0	45.0	-26.0
MAGAZINE, L.S. HASSELBLAD	A0108.1	116	3	AREA R13	4.2	1024.0	45.0	-26.0
PENETROMETER,RECORDING	G4049.	111	1	VOLUME CENTROID CM	2.0	1040.6	.0	.0

Table 3.5-9.3 (Continued)

MISSION J-1 TRANSFERRED CREW AND EQUIPMENT STOWAGE LIST								
ITEMS TRANSFERRED FROM ASC. STAGE INTO CM PRIOR TO ASC. STAGE JETTISON (16)								
APOLLO COORDINATES								
DESCRIPTION	STOW. ITEM	REF	NO.	STOWAGE LOCATION	WEIGHT	X-C.G.	Y-C.G.	Z-C.G.
BAG, EXTRA SAMPLE COLLECTION	G4048.	111	3	AREA A2	35.0	1010.0	-23.0	8.0
MAGAZINE, 16MM DATA ACQ.	A0101.1	116	5	IN XFR BAG (R13)	5.0	1024.0	45.0	-26.0
MAGAZINE, 16MM DATA ACQ.	A0101.1	116	2	AREA R13	2.0	1024.0	45.0	-26.0
MAGAZINE, 16MM DATA ACQ.	A0101.1	116	1	AREA R13	1.0	1024.0	45.0	-26.0
BAG, TRANSFER-16MM MAG.(2)	06432.	111	1	AREA R13	.1	1024.0	45.0	-26.0
BAG, TRANSFER-70MM MAG (3)	06434.	111	1	AREA R13	.5	1024.0	45.0	-26.0
2 CREW+EQUIP, LM-CM					830.21	1033.01	9.68	1.35

Table 3.5-9.3 (Continued)

MISSION J-1 TRANSFERRED CREW AND EQUIPMENT STOWAGE LIST								
ITEMS TRANSFERRED FROM CM INTO ASC. STAGE PRIOR TO ASC. STAGE JETTISON (17)								
APOLLO COORDINATES								
DESCRIPTION	STOW. ITEM	REF	NO.	STOWAGE LOCATION	WEIGHT	X-C.G.	Y-C.G.	Z-C.G.
SUBSYSTEM,FECAL CONTAINMENT	80113.	111	1	ON CREW-LMP(RH STA)	.3	1043.0	24.5	-10.4
SUBSYSTEM,FECAL CONTAINMENT	80113.	111	1	ON CREW-CDR(CTR.STA)	.3	1043.0	.0	-10.4
BAG, JETTISON STOWAGE	80147.	111	1	AREA A2	.9	1010.0	-23.0	8.0
FOOD PACKAGE	C0111.	111	1	AREA A7	50.0	1010.0	23.0	8.0
FECAL COLLECTION ASSY	00311.	111	12	AREA A7	2.4	1010.0	23.0	8.0
CO2 ABSORBER USED	00327.	121	4	AREA B5	26.8	1031.0	-8.0	39.0
CO2 ABSORBER USED	00327.	121	4	AREA B6	26.8	1031.0	13.0	39.0
CO2 ABSORBER USED	00327.	121	4	AREA A9	26.8	1013.0	.0	16.0
SHIM, CO2 ABSORBER	00328.	161	4	AREA B5	.8	1031.0	-8.0	39.0
SHIM, CO2 ABSORBER	00328.	161	4	AREA B6	.8	1031.0	13.0	39.0
SHIMS,CO2 ABSORBER	00328.	161	4	AREA A9	.8	1013.0	.0	16.0
CONTAINER,B5	00342.	111	1	AREA B5	14.5	1031.0	-8.0	39.0
CONTAINER,B6	00343.	111	1	AREA B6	14.5	1031.0	13.0	39.0
DOCKING PROBE AND MECHANISM	00349.	222	1	IN CM TUNNEL	193.5	1110.3	.0	.0
CONTAINGR A9	06348	111	1	AREA A9	14.7	1013.0	.0	16.0
COUPL.ASY,PGA O2 UMB.INTERCON.	00351.	116	1	AREA A8	.4	1012.0	22.0	-23.0
BAG,FECAL COLLECTON ASSY.	06418.	111	1	AREA A7	1.1	1010.0	23.0	8.0
CSM/LM UMBILICAL	T80	222	1	UNDER RH COUCH	1.1	1018.0	24.5	-15.0
EQUIP.XFR. CM-LM					376.50	1066.66	3.89	11.59

Table 3.5-9.3 (Continued)

MISSION J-1 TRANSFERRED CREW AND EQUIPMENT STOWAGE LIST								
ITEMS TRANSFERRED FROM CM INTO ASC. STAGE PRIOR TO ASC. STAGE JETTISON (18)								
LM COORDINATES								
DESCRIPTION	STOW. ITEM	REF	NO.	STOWAGE LOCATION	WEIGHT	X-C.G.	Y-C.G.	Z-C.G.
SUBSYSTEM,FECAL CONTAINMENT	80113.	111	1	VOLUME CENTROID AS	.3	254.0	.0	.0
SUBSYSTEM,FECAL CONTAINMENT	80113.	111	1	VOLUME CENTROID AS	.3	254.0	.0	.0
BAG, JETTISON STOWAGE	80147.	111	1	VOLUME CENTROID AS	.9	254.0	.0	.0
FOOD PACKAGE	C0111.	111	1	VOLUME CENTROID AS	50.0	254.0	.0	.0
FECAL COLLECTION ASSY	00311.	111	12	VOLUME CENTROID AS	2.4	254.0	.0	.0
CO2 ABSORBER USED	00327.	121	4	VOLUME CENTROID AS	26.8	254.0	.0	.0
CO2 ABSORBER USED	00327.	121	4	VOLUME CENTROID AS	26.8	254.0	.0	.0
CO2 ABSORBER USED	00327.	121	4	VOLUME CENTROID AS	26.8	254.0	.0	.0
SHIM, CO2 ABSORBER	00328.	161	4	VOLUME CENTROID AS	.8	254.0	.0	.0
SHIM, CO2 ABSORBER	00328.	161	4	VOLUME CENTROID AS	.8	254.0	.0	.0
SHIMS,CO2 ABSORBER	00328.	161	4	VOLUME CENTROID AS	.8	254.0	.0	.0
CONTAINER, B5	00342.	111	1	VOLUME CENTROID AS	14.5	254.0	.0	.0
CONTAINER, B6	00343.	111	1	VOLUME CENTROID AS	14.5	254.0	.0	.0
DOCKING PROBE	00349.	222	1	VOLUME CENTROID AS	81.8	254.0	.0	.0
DOCKING STRUCTURE	T8D	111	1	IN LM TUNNEL	111.7	314.7	.0	.0
CONTAINGR A9	06348	111	1	VOLUME CENTROID AS	14.7	254.0	.0	.0
COUPL.ASY,PGA O2 UMB.INTERCON.	00351.	116	1	VOLUME CENTROID AS	.4	254.0	.0	.0
BAG,FECAL COLLECTION ASSY.	06418.	111	1	VOLUME CENTROID AS	1.1	254.0	.0	.0
CSM/LM UMBILICAL	T8D	222	1	IN LM TUNNEL	1.1	300.0	.0	.0
EQUIP.XFR. CM-LM					376.50	272.14	.00	.00

Table 3.5-9.3 (Continued)

MISSION J-1 TRANSFERRED CREW AND EQUIPMENT STOWAGE LIST								
ITEMS REARRANGED IN ASC. STAGE PRIOR TO ASC. STAGE JETTISON (19)								
LM COORDINATES								
DESCRIPTION	STOW. ITEM	REF	NO.	STOWAGE LOCATION	WEIGHT	X-C.G.	Y-C.G.	Z-C.G.
DOCKING DROGUE	F1000.	112	1	IN LM TUNNEL	21.4	300.0	.0	.0
LM EQUIP.RELOC.3					21.40	300.00	.00	.00

U
N
I
T
E
D
S
T
A
T
E
S
O
F
A
M
E
R
I
C
A

Amendment 94
12/10/70

Table 3.5-9.3 (Continued)

MISSION J-1 TRANSFERRED CREW AND EQUIPMENT STOWAGE LIST								
ITEMS REARRANGED IN ASC. STAGE PRIOR TO ASC. STAGE JETTISON (20)								
LM COORDINATES								
DESCRIPTION	STOW. ITEM	REF	NO.	STOWAGE LOCATION	WEIGHT	X-C.G.	Y-C.G.	Z-C.G.
DOCKING DROGUE	F1000.	112	1	ON CABN FLOOR/DROGUE	21.4	218.5	-19.6	47.6
LM EQUIP.RELOC.3					21.40	218.50	-19.60	47.60

Table 3.5-9.3 (Continued)

MISSION J-1 TRANSFERRED CREW AND EQUIPMENT STOWAGE LIST								
ITEMS REARRANGED IN CM POST A/S JETTISON (21)								
DESCRIPTION	STOW. ITEM	REF	NO.	STOWAGE LOCATION	WEIGHT	APOLLO COORDINATES		
						X-C.G.	Y-C.G.	Z-C.G.
ADAPTER,CWG ELECTRICAL-CMP	80135.	111	1	IN ADAPTER BAG (A8)	.4	1012.0	22.0	-23.0
ADAPTER,CWG ELECTRICAL-COR	80135.	111	1	ON CREW-COR(CTR.STA)	.4	1043.0	.0	-10.4
ADAPTER,CWG ELECTRICAL-LMP	80135.	111	1	ON CREW-LMP(RH STA)	.4	1043.0	24.5	-10.4
HEADSET, LIGHT WEIGHT	E0104.	111	1	AREA A8	.4	1012.0	22.0	-23.0
HEADSET, LIGHT WEIGHT	E0104.	111	1	AREA A8	.4	1012.0	22.0	-23.0
HEADSET, LIGHT WEIGHT	E0104.	111	1	AREA A8	.4	1012.0	22.0	-23.0
ITLSA IV	80212.	111	1	ON CREW-CMP(LH STA)	40.4	1043.0	-24.5	-10.4
ITLSA EV	80211.	111	1	ON CREW-LMP(RH STA)	45.0	1043.0	24.5	-10.4
ITLSA EV	80211.	111	1	ON CREW-COR(CTR.STA)	45.0	1043.0	.0	-10.4
GLOVES,IV PAIR	80213.	111	1	ON CREW-CMP(LH STA)	2.1	1043.0	-24.5	-10.4
GLOVES,IV PAIR	80213.	111	1	ON CREW-LMP(RH STA)	2.1	1043.0	24.5	-10.4
GLOVES,IV PAIR	80213.	111	1	ON CREW-COR(CTR.STA)	2.1	1043.0	.0	-10.4
HELMET ASSY, PRESSURE	80214.	111	1	ON CREW-CMP(LH STA)	2.6	1043.0	-24.5	-10.4
HELMET ASSY, PRESSURE	80214.	111	1	ON CREW-LMP(RH STA)	2.6	1043.0	24.5	-10.4
HELMET ASSY, PRESSURE	80214.	111	1	ON CREW-COR(CTR.STA)	2.6	1043.0	.0	-10.4
COMMUNICATION CARRIER	80217.	111	1	ON CREW-CMP(LH STA)	1.6	1043.0	-24.5	-10.4
COMMUNICATION CARRIER	80217.	111	1	ON CREW-LMP(RH STA)	1.6	1043.0	24.5	-10.4
COMMUNICATION CARRIER	80217.	111	1	ON CREW-COR(CTR.STA)	1.6	1043.0	.0	-10.4
POCKET, CHECKLIST + SCISSORS	80218.	111	1	ON PGA (CREW-LH STA)	.2	1043.0	-24.5	-10.4
POCKET, CHECKLIST + SCISSORS	80218.	111	1	ON PGA (CREW-RH STA)	.2	1043.0	24.5	-10.4
POCKET, CHECKLIST + SCISSORS	80218.	111	1	ON PGA (CREW-CTR STA)	.2	1043.0	.0	-10.4
POCKET, CHECKLIST	80219.	111	1	ON PGA (CREW-RH STA)	.2	1043.0	24.5	-10.4
POCKET, CHECKLIST	80219.	111	1	ON PGA (CREW-CTR STA)	.2	1043.0	.0	-10.4
GARMENT, LIQUID COOLING	81030.	111	1	ON CREW-LMP(RH STA)	6.9	1043.0	24.5	-10.4
GARMENT, LIQUID COOLING	81030.	111	1	ON CREW-COR(CTR.STA)	6.9	1043.0	.0	-10.4
JACKET ASSY, ICG	80112.1	111	1	AREA U2	1.8	1033.0	-23.0	-50.2
JACKET ASSY, ICG	80112.1	111	1	AREA U2	1.8	1033.0	-23.0	-50.2
JACKET ASSY, ICG	80112.1	111	1	AREA U2	1.8	1033.0	-23.0	-50.2
TROUSER ASSY, ICG	80112.2	111	1	AREA U2	1.8	1033.0	-23.0	-50.2
TROUSER ASSY, ICG	80112.2	111	1	AREA U2	1.8	1033.0	-23.0	-50.2
TROUSER ASSY, ICG	80112.2	111	1	AREA U2	1.8	1033.0	-23.0	-50.2
BOOT, RIGHT, ICG	80112.3	111	1	AREA U2	.4	1033.0	-23.0	-50.2

Table 3.5-9.3 (Continued)

MISSION J-1 TRANSFERRED CREW AND EQUIPMENT STOWAGE LIST								
ITEMS REARRANGED IN CM POST A/S JETTISON (21)								
DESCRIPTION	STOW. ITEM	REF	NO.	STOWAGE LOCATION	WEIGHT	APOLLO COORDINATES		
						X-C.G.	Y-C.G.	Z-C.G.
BOOT,RIGHT,ICG	80112.3	111	1	AREA U2	.4	1033.0	-23.0	-50.2
BOOT,RIGHT,ICG	80112.3	111	1	AREA U2	.4	1033.0	-23.0	-50.2
BOOT,LEFT,ICG	80112.4	111	1	AREA U2	.4	1033.0	-23.0	-50.2
BOOT,LEFT,ICG	80112.4	111	1	AREA U2	.4	1033.0	-23.0	-50.2
BOOT,LEFT,ICG	80112.4	111	1	AREA U2	.4	1033.0	-23.0	-50.2
BAG,MOTION SICKNESS	A0208.	111	1	ON PGA (CREW-LH STA)	.1	1043.0	-24.5	-10.4
BAG,MOTION SICKNESS	A0208.	111	1	ON PGA (CREW-RH STA)	.1	1043.0	24.5	-10.4
BAG,MOTION SICKNESS	A0208.	111	1	ON PGA(CREW-CTR STA)	.1	1043.0	.0	-10.4
POCKET,CHECKLIST + SCISSORS	80201.5	167	1	ON PGA (CREW-LH STA)	NEGL	1043.0	-24.5	-10.4
BAG,DECONTAMINATION,SRC NO. 1	06331.	111	1	AREA A2	.9	1010.0	-23.0	8.0
BAG,DECONTAMINATION,SRC NO. 2	06331.	111	1	AREA A2	.9	1010.0	-23.0	8.0
BAG,DECONTAMINATION,SRC NO. 3	06331.	111	1	AREA A2	.9	1010.0	-23.0	8.0
CONTAINGR,EVA EQUIPMENT	06358	111	1	AREA A2	NEGL	1010.0	-23.0	8.0
WAIST RESTRAINT, IV CREWMAN	06365.	111	1	AREA A2	NEGL	1010.0	-23.0	8.0
CARRIER ASSY, CONT. A9	06403.	111	1	AREA A9	NEGL	1013.0	.0	16.0
EARTUBE,UNIVERSAL	E0105.	111	1	AREA U2	NEGL	1033.0	-23.0	-50.2
EARTUBE,UNIVERSAL	E0105.	111	1	AREA U2	NEGL	1033.0	-23.0	-50.2
EARTUBE,UNIVERSAL	E0105.	111	1	AREA U2	NEGL	1033.0	-23.0	-50.2
SUBSYSTEM,FECAL CONTAINMENT	80113.	111	1	ON CREW-CMP(LH STA)	.3	1043.0	-24.5	-10.4
GARMET,CONSTANT WEAR	80208.	111	1	AREA U2	.8	1033.0	-23.0	-50.2
GARMET,CONSTANT WEAR	80208.	111	1	AREA U2	.8	1033.0	-23.0	-50.2
TETHER,IV CREWMAN	06429.	111	1	AREA A2	T80	1010.0	-23.0	8.0
BAG,DECON,LUNAR SAMPLE	06426.	111	1	AREA A2	5.0	1010.0	-23.0	8.0
BAG, DECONTAMINATION 16MM MAG.	06433.	111	1	AREA A2	.3	1010.0	-23.0	8.0
BAG, DECONTAMINATION 70MM MAG.	06435.	111	1	AREA A2	.3	1010.0	-23.0	8.0
CM EQUIP.RELOC.3					190.22	1040.52	-1.09	-12.80

Table 3.5-9.3 (Continued)

MISSION J-1 TRANSFERRED CREW AND EQUIPMENT STORAGE LIST								
ITEMS REARRANGED IN CM POST A/S JETTISON (22)								
APOLLO COORDINATES								
DESCRIPTION	STOW. ITEM	REF	NO.	STOWAGE LOCATION	WEIGHT	X-C.G.	Y-C.G.	Z-C.G.
ADAPTER,CWG ELECTRICAL-CMP	B0135.	111	1	ON CREW-LMP(RH STA)	.4	1043.0	24.5	-10.4
ADAPTER,CWG ELECTRICAL-COR	B0135.	111	1	ON CREW-COR(CTR.STA)	.4	1043.0	.0	-10.4
ADAPTER,CWG ELECTRICAL-LMP	B0135.	111	1	ON CREW-CMP(LH STA)	.4	1043.0	-24.5	-10.4
HEADSET, LIGHT WEIGHT	E0104.	111	1	ON CREW-CMP(LH STA)	.4	1043.0	-24.5	-10.4
HEADSET, LIGHT WEIGHT	E0104.	111	1	ON CREW-LMP(RH STA)	.4	1043.0	24.5	-10.4
HEADSET, LIGHT WEIGHT	E0104.	111	1	ON CREW-COR(CTR.STA)	.4	1043.0	.0	-10.4
ITLSA IV	B0212.	111	1	AFT UPR EQUIP.BAY-RH	40.4	1018.0	25.0	-47.9
ITLSA EV	B0211.	111	1	IN CM PGA CONTAINER	45.0	1015.0	.0	-19.9
ITLSA EV	B0211.	111	1	IN CM PGA CONTAINER	45.0	1015.0	.0	-19.9
GLOVES,IV PAIR	B0213.	111	1	HELMET STOW.BAG (L3)	2.1	1048.0	-47.0	12.0
GLOVES,IV PAIR	B0213.	111	1	HELMET STOW BAG (B1)	2.1	1050.0	-27.0	39.0
GLOVES,IV PAIR	B0213.	111	1	AFT UPR EQUIP.BAY-RH	2.1	1018.0	25.0	-47.9
HELMET ASSY, PRESSURE	B0214.	111	1	AFT UPR EQUIP.BAY-RH	2.6	1018.0	25.0	-47.9
HELMET ASSY, PRESSURE	B0214.	111	1	HELMET STOW BAG (B1)	2.6	1050.0	-27.0	39.0
HELMET ASSY, PRESSURE	B0214.	111	1	HELMET STOW.BAG (L3)	2.6	1048.0	-47.0	12.0
COMMUNICATION CARRIER	B0217.	111	1	GNIC PANEL	1.6	1050.0	.0	22.0
COMMUNICATION CARRIER	B0217.	111	1	GNIC PANEL	1.6	1050.0	.0	22.0
COMMUNICATION CARRIER	B0217.	111	1	GNIC PANEL	1.6	1050.0	.0	22.0
POCKET, CHECKLIST + SCISSORS	B0218.	111	1	ON ICG-CMP./LH STA.	.2	1043.0	-24.5	-10.4
POCKET, CHECKLIST + SCISSORS	B0218.	111	1	ON ICG-LMP./RH STA.	.2	1043.0	24.5	-10.4
POCKET, CHECKLIST + SCISSORS	B0218.	111	1	ON ICG-COR./CTR.STA.	.2	1043.0	.0	-10.4
POCKET, CHECKLIST	B0219.	111	1	ON ICG-COR./CTR.STA.	.2	1043.0	.0	-10.4
POCKET, CHECKLIST	B0219.	111	1	ON ICG-LMP./RH STA.	.2	1043.0	24.5	-10.4
GARMENT,LIQUID COOLING	B1030.	111	1	AREA U1	6.9	1033.0	23.0	-50.0
GARMENT,LIQUID COOLING	B1030.	111	1	AREA U1	6.9	1033.0	23.0	-50.0
JACKET ASSY,ICG	B0112.1	111	1	ON CREW-LMP(RH STA)	1.8	1043.0	24.5	-10.4
JACKET ASSY,ICG	B0112.1	111	1	ON CREW-COR(CTR.STA)	1.8	1043.0	.0	-10.4
JACKET ASSY,ICG	B0112.1	111	1	ON CREW-CMP(LH STA)	1.8	1043.0	-24.5	-10.4
TROUSER ASSY,ICG	B0112.2	111	1	ON CREW-LMP(RH STA)	1.8	1043.0	24.5	-10.4
TROUSER ASSY,ICG	B0112.2	111	1	ON CREW-COR(CTR.STA)	1.8	1043.0	.0	-10.4
TROUSER ASSY,ICG	B0112.2	111	1	ON CREW-CMP(LH STA)	1.8	1043.0	-24.5	-10.4
BOOT,RIGHT,ICG	B0112.3	111	1	ON CREW-LMP(RH STA)	.4	1043.0	24.5	-10.4

Table 3.5-9.3 (Continued)

MISSION J-1 TRANSFERRED CREW AND EQUIPMENT STORAGE LIST								
ITEMS REARRANGED IN CM POST A/S JETTISON (22)								
						APOLLO COORDINATES		
DESCRIPTION	STOW. ITEM	REF	NO.	STOWAGE LOCATION	WEIGHT	X-C.G.	Y-C.G.	Z-C.G.
BOOT,RIGHT,ICG	80112.3	111	1	ON CREW-CDR(CTR.STA)	.4	1043.0	.0	-10.4
BOOT,RIGHT,ICG	80112.3	111	1	ON CREW-CMP(LH STA)	.4	1043.0	-24.5	-10.4
BOOT,LEFT, ICG	80112.4	111	1	ON CREW-LMP(RH STA)	.4	1043.0	24.5	-10.4
BOOT,LEFT, ICG	80112.4	111	1	ON CREW-CDR(CTR.STA)	.4	1043.0	.0	-10.4
BOOT,LEFT, ICG	80112.4	111	1	ON CREW-CMP(LH STA)	.4	1043.0	-24.5	-10.4
BAG,MOTION SICKNESS	A0208.	111	1	ON PGA(PGA CONTAINR)	.1	1015.0	.0	-19.9
BAG,MOTION SICKNESS	A0208.	111	1	ON PGA(PGA CONTAINR)	.1	1015.0	.0	-19.9
BAG,MOTION SICKNESS	A0208.	111	1	ON PGA(PGA CONTAINR)	.1	1015.0	.0	-19.9
POCKET,CHECKLIST + SCISSORS	80201.5	167	1	ON ICG-CMP./LH STA.	NEGL	1043.0	-24.5	-10.4
BAG,DECONTAMINATION,SRC NO. 1	06331.	111	1	AREA B5	.9	1031.0	-8.0	39.0
BAG,DECONTAMINATION,SRC NO. 2	06331.	111	1	AREA B6	.9	1031.0	13.0	39.0
BAG,DECONTAMINATION,SRC NO. 3	06331.	111	1	AREA A9	.9	1013.0	.0	16.0
CONTAINGR,EVA EQUIPMENT	06358	111	1	AREA A7	NEGL	1010.0	23.0	8.0
WAIST RESTRAINT, IV CREWMAN	06365.	111	1	AREA A7	NEGL	1010.0	23.0	8.0
CARRIER ASSY, CONT. A9	06403.	111	1	AREA A9	NEGL	1013.0	.0	16.0
EARTUBE,UNIVERSAL	E0105.	111	1	ON CREW-LMP(RH STA)	NEGL	1043.0	24.5	-10.4
EARTUBE,UNIVERSAL	E0105.	111	1	ON CREW-CDR(CTR.STA)	NEGL	1043.0	.0	-10.4
EARTUBE,UNIVERSAL	E0105.	111	1	ON CREW-CMP(LH STA)	NEGL	1043.0	-24.5	-10.4
SUBSYSTEM,FECAL CONTAINMENT	80113.	111	1	AREA A2	.3	1010.0	-23.0	8.0
GARMET,CONSTANT WEAR	80208.	111	1	ON CREW-LMP(RH STA)	.8	1043.0	24.5	-10.4
GARMET,CONSTANT WEAR	80208.	111	1	ON CREW-CDR(CTR.STA)	.8	1043.0	.0	-10.4
TETHER, IV CREWMAN	06429.	111	1	AREA A7	TBD	1010.0	23.0	8.0
BAG,DECON,LUNAR SAMPLE	06426.	111	1	AREA A7	5.0	1010.0	23.0	8.0
BAG, DECONTAMINATION 16MM MAG.	06433.	111	1	AREA R13	.3	1024.0	45.0	-26.0
BAG, DECONTAMINATION 70MM MAG.	06435.	111	1	AREA R13	.3	1024.0	45.0	-26.0
CM EQUIP.RELOC. 3					190.22	1022.29	6.63	-23.03

Table 3.5-9.3 (Continued)

MISSION J-1 TRANSFERRED CREW AND EQUIPMENT STORAGE LIST								
ITEMS TRANSFERRED FROM SM TO CM DURING SIM EVA (23)								
APOLLO COORDINATES								
DESCRIPTION	STOW. ITEM	REF	NO.	STOWAGE LOCATION	WEIGHT	X-C.G.	Y-C.G.	Z-C.G.
MAGAZINE, 24 IN. PAN. CAMERA	P0400.	115	1	IN SIM BAY (3IN)	66.0	945.5	34.5	-52.5
MAGAZINE, 3 IN. MAP. CAMERA	P0401.	115	1	IN SIM BAY (24 IN)	23.1	886.0	53.0	-56.0
EQUIP.XFR. SM-CM					89.10	930.07	39.30	-53.41

Table 3.5-9.3 (Continued)

MISSION J-1 TRANSFERRED CREW AND EQUIPMENT STOWAGE LIST								
ITEMS TRANSFERRED FROM SM TO CM DURING SIM EVA (24)								
APOLLO COORDINATES								
DESCRIPTION	STOW. ITEM	REF	NO.	STOWAGE LOCATION	WEIGHT	X-C.G.	Y-C.G.	Z-C.G.
MAGAZINE, 24 IN. PAN. CAMERA	P0400.	115	1	AREA A2	66.0	1010.0	-23.0	8.0
MAGAZINE, 3 IN. MAP. CAMERA	P0401.	115	1	BAG, RETURN EQUIP (BII)	23.1	1050.0	-27.0	39.0
EQUIP. XFR. SM-CM					89.10	1020.37	-24.04	16.04

Table 3.5-9.3 (Continued)

MISSION J-1 TRANSFERRED CREW AND EQUIPMENT STOWAGE LIST								
ITEMS OFFLOADED FROM CSM POST SIM EVA-(25)								
DESCRIPTION	STOW. ITEM	REF	NO.	STOWAGE LOCATION	WEIGHT	APOLLO COORDINATES		
						X-C.G.	Y-C.G.	Z-C.G.
BAG, JETTISON STOWAGE ITEMS, FOOD + HYGIENE	80147.	111	2	AREA A2	1.8	1010.0	-23.0	8.0
	C0100.	111	1	AREA B1	30.8	1050.0	-27.0	39.0
EVA OFFLOAD					32.60	1047.79	-26.78	37.29

Table 3.5-9.3 (Continued)

MISSION J-1 TRANSFERRED CREW AND EQUIPMENT STOWAGE LIST								
ITEMS REARRANGED IN CM PRIOR TO ENTRY (27)								
				APOLLO COORDINATES				
DESCRIPTION	STOW. ITEM	REF	NO.	STOWAGE LOCATION	WEIGHT	X-C.G.	Y-C.G.	Z-C.G.
HEADSET, LIGHT WEIGHT	E0104.	111	1	ON CREW-CMP(LH STA)	.4	1043.0	-24.5	-10.4
HEADSET, LIGHT WEIGHT	E0104.	111	1	ON CREW-LMP(RH STA)	.4	1043.0	24.5	-10.4
HEADSET, LIGHT WEIGHT	E0104.	111	1	ON CREW-CDR(CTR.STA)	.4	1043.0	.0	-10.4
COMMUNICATION CARRIER	80217.	111	1	GNIC PANEL	1.6	1050.0	.0	22.0
COMMUNICATION CARRIER	80217.	111	1	GNIC PANEL	1.6	1050.0	.0	22.0
COMMUNICATION CARRIER	80217.	111	1	GNIC PANEL	1.6	1050.0	.0	22.0
POCKET, CHECKLIST + SCISSORS	80218.	111	1	ON ICG-CMP./LH STA.	.2	1043.0	-24.5	-10.4
POCKET, CHECKLIST + SCISSORS	80218.	111	1	ON ICG-CDR./CTR.STA.	.2	1043.0	.0	-10.4
POCKET, CHECKLIST + SCISSORS	80218.	111	1	ON ICG-LMP./RH STA.	.2	1043.0	24.5	-10.4
POCKET, CHECKLIST	80219.	111	1	ON ICG-CMP./LH STA.	.2	1043.0	-24.5	-10.4
POCKET, CHECKLIST	80219.	111	1	ON ICG-CDR./CTR.STA.	.2	1043.0	.0	-10.4
POCKET, CHECKLIST	80219.	111	1	ON ICG-LMP./RH STA.	.2	1043.0	24.5	-10.4
PAD, HEADREST	80130.	117	1	AREA A2	1.1	1010.0	-23.0	8.0
PAD, HEADREST	80130.	117	1	AREA A2	1.1	1010.0	-23.0	8.0
PAD, HEADREST	80130.	117	1	AREA A2	1.1	1010.0	-23.0	8.0
HEEL RESTRAINT (PR)	80132.	117	1	AREA A2	1.2	1010.0	-23.0	8.0
HEEL RESTRAINT (PR)	80132.	117	1	AREA A2	1.2	1010.0	-23.0	8.0
HEEL RESTRAINT (PR)	80132.	117	1	AREA A2	1.2	1010.0	-23.0	8.0
GLOVES, EV-(CMP)	80150.	111	1	AREA A2	3.0	1010.0	-23.0	8.0
POCKET, CHECKLIST + SCISSORS	80201.5	167	1	IN HSB (U2)	NEGL	1033.0	-23.0	-50.2
VEST, DUAL LIFE	80202.	111	1	IN HSB (U2)	2.4	1033.0	-23.0	-50.2
VEST, DUAL LIFE	80202.	111	1	IN HSB (U2)	NEGL	1033.0	-23.0	-50.2
VEST, DUAL LIFE	80202.	111	1	IN HSB (U2)	NEGL	1033.0	-23.0	-50.2
CONTAINER, R12	00344.	115	1	RH GIRTH RING	2.7	1034.0	41.0	-21.0
FILTER, CABIN FAN	06395.	111	1	AREA U2	2.4	1033.0	-23.0	-50.2
STOWAGE BAG, CABIN FAN FILTER	06410.	111	1	AREA A2	1.6	1010.0	-23.0	8.0
EARTUBE, UNIVERSAL	E0105.	111	1	ON CREW-LMP(RH STA)	NEGL	1043.0	24.5	-10.4
EARTUBE, UNIVERSAL	E0105.	111	1	ON CREW-CDR(CTR.STA)	NEGL	1043.0	.0	-10.4
EARTUBE, UNIVERSAL	E0105.	111	1	ON CREW-CMP(LH STA)	NEGL	1043.0	-24.5	-10.4
CM EQUIP. RELOC. 4					26.20	1027.04	-10.08	-4.77

Table 3.5-9.3 (Continued)

MISSION J-1 TRANSFERRED CREW AND EQUIPMENT STOWAGE LIST								
ITEMS REARRANGED IN CM PRIOR TO ENTRY (29)								
						APOLLO COORDINATES		
DESCRIPTION	STOW. ITEM	REF	NO.	STOWAGE LOCATION	WEIGHT	X-C.G.	Y-C.G.	Z-C.G.
HEADSET, LIGHT WEIGHT	E0104.	111	1	AREA A8	.4	1012.0	22.0	-23.0
HEADSET, LIGHT WEIGHT	E0104.	111	1	AREA A8	.4	1012.0	22.0	-23.0
HEADSET, LIGHT WEIGHT	E0104.	111	1	AREA A8	.4	1012.0	22.0	-23.0
COMMUNICATION CARRIER	80217.	111	1	ON CREW-CMP(LH STA)	1.6	1043.0	-24.5	-10.4
COMMUNICATION CARRIER	80217.	111	1	ON CREW-LMP(RH STA)	1.6	1043.0	24.5	-10.4
COMMUNICATION CARRIER	80217.	111	1	ON CREW-CDR(CTR.STA)	1.6	1043.0	.0	-10.4
POCKET, CHECKLIST + SCISSORS	80218.	111	1	ON CREW-LMP(RH STA)	.2	1043.0	24.5	-10.4
POCKET, CHECKLIST + SCISSORS	80218.	111	1	ON CREW-CDR(CTR.STA)	.2	1043.0	.0	-10.4
POCKET, CHECKLIST + SCISSORS	80218.	111	1	ON CREW-CMP(LH STA)	.2	1043.0	-24.5	-10.4
POCKET, CHECKLIST	80219.	111	1	ON CREW-LMP(RH STA)	.2	1043.0	24.5	-10.4
POCKET, CHECKLIST	80219.	111	1	ON CREW-CDR(CTR.STA)	.2	1043.0	.0	-10.4
POCKET, CHECKLIST	80219.	111	1	ON CREW-CMP(LH STA)	.2	1043.0	-24.5	-10.4
PAD, HEADREST	80130.	117	1	ON COUCH(RH CREW STA)	1.1	1043.0	24.5	-10.4
PAD, HEADREST	80130.	117	1	ON COUCH(CTR CREW STA)	1.1	1043.0	.0	-10.4
PAD, HEADREST	80130.	117	1	ON COUCH(LH CREW STA)	1.1	1043.0	-24.5	-10.4
HEEL RESTRAINT (PR)	80132.	117	1	ON CREW-LMP(RH STA)	1.2	1043.0	24.5	-10.4
HEEL RESTRAINT (PR)	80132.	117	1	ON CREW-CDR(CTR.STA)	1.2	1043.0	.0	-10.4
HEEL RESTRAINT (PR)	80132.	117	1	ON CREW-CMP(LH STA)	1.2	1043.0	-24.5	-10.4
GLOVES, EV-(CMP)	80150.	111	1	AFT UPR EQUIP. BAY-LH	3.0	1018.0	-21.9	-49.9
POCKET, CHECKLIST + SCISSORS	80201.5	167	1	ON CREW-CMP(CTR STA)	NEGL	1043.0	.0	-10.4
VEST, DUAL LIFE	80202.	111	1	ON CREW-CDR(CTR.STA)	2.4	1043.0	.0	-10.4
VEST, DUAL LIFE	80202.	111	1	ON CREW-CMP(LH STA)	NEGL	1043.0	-24.5	-10.4
VEST, DUAL LIFE	80202.	111	1	ON CREW-LMP(RH STA)	NEGL	1043.0	24.5	-10.4
CONTAINER, R12	00344.	115	1	AREA R3	2.7	1072.0	26.0	9.0
FILTER, CABIN FAN	06395.	111	1	AREA A1	2.4	1012.0	-22.0	-26.0
STOWAGE BAG, CABIN FAN FILTER	06410.	111	1	AREA A1	1.6	1012.0	-22.0	-26.0
EARTUBE, UNIVERSAL	E0105.	111	1	AREA U2	NEGL	1033.0	-23.0	-50.2
EARTUBE, UNIVERSAL	E0105.	111	1	AREA U2	NEGL	1033.0	-23.0	-50.2
EARTUBE, UNIVERSAL	E0105.	111	1	AREA U2	NEGL	1033.0	-23.0	-50.2
CM EQUIP. RELOC.4					26.20	1036.97	-2.18	-15.89

TABLE 3.5-10
CONSUMABLES LOADING REQUIREMENTS AND TOLERANCES

Amendment 86
 9/10/70

MISSION J-1
SPS PROPELLANT

Pressure (PSIA)		Temperature (°F)		Quantity Readout (%)	
Fuel	Oxidizer	Fuel	Oxidizer	Fuel	Oxidizer
110±4	110±4	70±5	70±5	See Figure 4.1-3	See Figure 4.1-4

SPS Propellant Load (lb)	Loading Requirement		Actual	
	Fuel	Oxidizer	Fuel	Oxidizer
¹ Load	15704.0	25092.0		
² Trapped Outside Tanks	78.6	123.7		
Tanked	15625.4	24968.3		
² Trapped Inside Tanks	67.6	171.5		
³ Nominal Deliverable	15557.8	24796.8		

⁴Service Module RCS Propellant

Secondary Fuel - Quads A, B, C, D - See Loading Window - Figure 4.3-1.

Primary Fuel - Quads A, B, C, D - See Loading Window - Figure 4.3-2.

Primary and Secondary Oxidizer - Quads A, B, C, D - See Loading Window - Figure 4.3-3.

⁵Command Module RCS Propellant

Fuel - System A and B - See Loading Window - Figure 4.3-4.

Oxidizer - System A and B - See Loading Window - Figure 4.3-5.

⁹Helium and Nitrogen

Consumable	Loading Requirement			Actual	
	Pressure	Temp	Weight	Earth Launch	Pressure Temp
	(PSIA)	(°F)	(lb)	Weight (lb)	(PSIA) (°F)
Helium - SPS Bottles	3600	70	87.6	87.6	
Helium - Fuel Tanks	178	70	5.4		
Helium - N ₂ O ₄ Tanks	178	70			
Helium - SM/RCS					
Quads A	4150	70	6.0	6.0	
Quads B	4150	70			
Quads C	4150	70			
Quads D	4150	70			
Helium - CM/RCS					
System A	4150	70	1.0	1.0	
System B	4150	70			
Nitrogen - SM					
Primary	2500	85	1.3	1.3	
Secondary	2500	85			



TABLE 3.5-10 (Continued)

Amendment 86
9/10/70

Command Module Water and GOX

	Pressure (PSIA)	Loading Requirement Weight (lb)	Earth Launch Weight (lb)	Actual
Waste Water ⁶			18.0	
Potable Water ⁷			36.0	
CM/GOX	900±50	3.7	6.7 (Entry)	

⁸Service Module Hydrogen and Oxygen

	Loading Req. Per Tank (pounds)	Earth Launch Weight Per Tank (lb)
Hydrogen		
Tank 1	29.3	27.6
Tank 2	29.3	27.6
Tank 3	29.3	27.6
Oxygen		
Tank 1	330.1	316.6
Tank 2	330.1	316.6
Tank 3	330.1	316.6

NOTES:

¹Indicated propellant load is based on nominal pressure and temperature prior to actual loading. This number will be updated after loading is accomplished.

²See Section 4.1 for explanation of trapped SPS propellant.

³See Table 3.5-13 for loading uncertainties.

⁴See Section 4.2 for SM/RCS loads and uncertainties to be used in Mission Planning. Actual SM/RCS loads and uncertainties will be published in Table 3.5-15.

⁵See Section 4.2 for CM/RCS loads and uncertainties to be used in Mission Planning. Actual CM/RCS loads and uncertainties will be published in Table 3.5-14.

⁶Launch Rule Redlines determine lift-off values.

⁷Launch Rule Redlines determine lift-off values.

⁸Launch Mission Rules will determine minimum lift-off quantities for H₂ and O₂.

⁹CSM helium and nitrogen should be loaded in accordance with loading windows contained in CSM/LM Spacecraft Operational Data Book, Volume I, Part 2, SNA-8-D-027(1) P2.

SNA-8-D-027(III)REV 2



SPS PROPELLANT LOAD CALCULATIONS

	<u>Fuel</u>	<u>Oxidizer</u>
1. Enter SPS Quantity Readout at 110 PSIA (Table 3.5-12 Item C - Percent)	_____	_____
2. Use Figures 4.1-3 and 4.1-4 to obtain propellant load for above quantity readout.	_____	_____
3. Nominal propellant density at loading temperature (use temperature - density graph below) (lb/ft ³)	_____	_____
4. Cubic feet of propellant (Item 2 divided by Item 3)	_____	_____
5. Calculated density from Table 3.5-12 Item F (lb/ft ³)	_____	_____
6. Adjustment due to PUGS zero adjust (pounds)	_____	_____
7. Resulting actual propellant load (Item 4 times Item 5, less Item 6) (pounds)	_____	_____

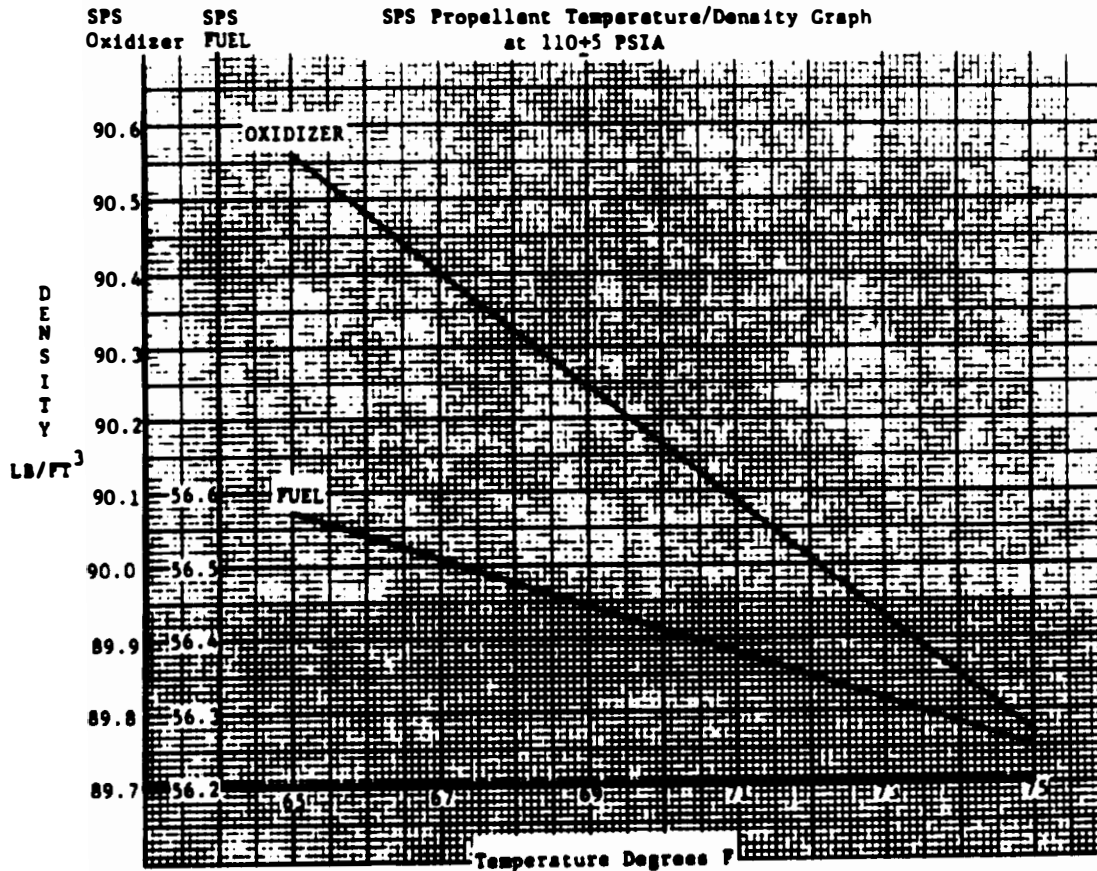

TABLE 3.5-12

Mission J-1 SPS Propellant Load Parameters
(To be provided by KSC following loading)

Enter the following information at zero adjust - time	
<u>Fuel</u>	<u>Oxidizer</u>
Adjusted quantity fuel readout - Percent _____	Adjusted quantity oxidizer readout - Percent _____
Fuel storage voltage reading taken from ACE to three significant digits - volts _____	Oxidizer storage voltage reading taken from ACE to three significant digits - volts _____
Fuel sump voltage reading taken from ACE to three significant digits - volts _____	Oxidizer sump voltage reading taken from ACE to three significant digits - volts _____

Enter the following information at Sump Tank Full Adjust
(Propellant at top of standpipe)

<u>Fuel</u>	<u>Oxidizer</u>
Fuel sump tank pressure - PSIA _____	Oxidizer sump tank pressure - PSIA _____
Fuel temperature - °F _____	Oxidizer temperature - °F _____
Adjusted quantity fuel readout - Percent _____	Adjusted quantity oxidizer readout - % _____
Fuel sump voltage reading taken from ACE to three significant digits - volts _____	Oxidizer sump voltage reading taken from ACE to three significant digits - volts _____

Enter the following information at Storage Tank Full Adjust
(Propellant at Point Sensor #1)

<u>Fuel</u>	<u>Oxidizer</u>
Fuel storage tank pressure - PSIA _____	Oxidizer storage tank pressure - PSIA _____
Fuel temperature - °F _____	Oxidizer temperature - °F _____
Adjusted quantity fuel readout - % _____	Adjusted quantity oxidizer readout - % _____
Fuel storage voltage reading taken from ACE to three significant digits - volts _____	Oxidizer storage voltage reading taken from ACE to three significant digits - volts _____
Fuel sump voltage reading taken from ACE to three significant digits - volts _____	Oxidizer sump voltage reading taken from ACE to three significant digits - volts _____

TABLE 3.5-12 (Continued)

Enter the following information when tanking is complete (110.5 PSIA) Time	
<u>Fuel</u>	<u>Oxidizer</u>
a. System pressure - PSIA _____	a. System pressure - PSIA _____
b. Fuel temperature - °F _____	b. Oxidizer temperature - °F _____
c. Quantity fuel readout - Z _____	c. Quantity oxidizer readout - Z _____
d. Fuel measured specific gravity @ °C - 14.7 PSIA _____	d. Oxidizer measured specific gravity @ °C - 14.7 PSIA _____
e. Fuel measured density °C - 14.7 PSIA (Item d times 62.428) - lb/ft ³ _____	e. Oxidizer measured density @ °C - 14.7 PSIA (Item d times 62.428) - lb/ft ³ _____
f. Calculated density - lb/ft ³ - at system pressure and temperature Item a and b above. Use density equation outlined in Section 4.1. _____	f. Calculated density - lb/ft ³ - at system pressure and temperature, Item a and b above. Use density equation outlined in Section 4.1. _____
g. Fuel storage voltage reading from ACE _____	g. Oxidizer storage voltage reading from ACE _____
h. Fuel sump voltage reading from ACE _____	h. Oxidizer sump voltage reading from ACE _____

Enter the following information at leak check pressure	
<u>Fuel</u>	<u>Oxidizer</u>
System pressure - PSIA _____	System pressure - PSIA _____
Quantity fuel readout - Z _____	Quantity oxidizer readout - Z _____
Fuel storage voltage reading from ACE _____	Oxidizer storage voltage readout from ACE _____
Fuel sump voltage reading from ACE _____	Oxidizer sump voltage readout from ACE _____

TABLE 3.5-14

Command Module RCS Loading Parameters and Calculations

This table will be completed when loading is accomplished. For Mission Planning, reference should be made to Section 4.2 for nominal load, loading tolerances, trapped and deliverable propellants.

	<u>FUEL</u>		<u>OXIDIZER</u>	
	<u>Tank A</u>	<u>Tank B</u>	<u>Tank A</u>	<u>Tank B</u>
A. Tank Volume @ 0.0 PSIA (in ³)	_____	_____	_____	_____
B. Liquid Line Volume (in ³)	_____	_____	_____	_____
C. Total A + B (in ³)	_____	_____	_____	_____
D. Initial Weight in Bleed Unit Prior to Loading (lb)	_____	_____	_____	_____
E. Final Weight in Bleed Unit After Loading (lb)	_____	_____	_____	_____
F. Propellant Load (item D less than E Weigh Tank)	_____	_____	_____	_____
G. Propellant Load by P.V.	_____	_____	_____	_____
H. Loading Temperature (°F)	_____	_____	_____	_____
I. Specification Propellant Load @ 70±5°F (lb)	_____	_____	_____	_____
J. Total CM/RCS Propellant Load from Item G above (lb)	_____	_____	_____	_____
K. Maximum Trapped Propellant (lb)	_____	_____	_____	_____
L. Nominal Deliverable (lb)	_____	_____	_____	_____



TABLE 3.5-15

SERVICE MODULE RCS LOADING SUMMATION

This table will be completed when loading is accomplished. For Mission Planning, reference should be made to Section 4.2, for nominal load, loading tolerances, and nominal deliverable propellants.

<u>Quad A (lb)</u>		<u>Quad B (lb)</u>	
Secondary fuel	_____	Secondary fuel	_____
Primary fuel	_____	Primary Fuel	_____
Total fuel	_____ ±0.7	Total fuel	_____ ±0.7
Maximum Trapped	<u>2.1</u>	Maximum Trapped	<u>2.1</u>
Nominal Deliverable	_____	Nominal Deliverable	_____
Total Oxidizer	_____ ±2.3	Total Oxidizer	_____ ±2.3
Maximum Trapped	<u>4.5</u>	Maximum Trapped	<u>4.5</u>
Nominal Deliverable	_____	Nominal Deliverable	_____
<u>Quad C (lb)</u>		<u>Quad D (lb)</u>	
Secondary fuel	_____	Secondary fuel	_____
Primary fuel	_____	Primary fuel	_____
Total fuel	_____ ±0.7	Total fuel	_____ ±0.7
Maximum Trapped	<u>2.1</u>	Maximum Trapped	<u>2.1</u>
Nominal Deliverable	_____	Nominal Deliverable	_____
Total Oxidizer	_____ ±2.3	Total Oxidizer	_____ ±2.3
Maximum Trapped	<u>4.5</u>	Maximum Trapped	<u>4.5</u>
Nominal Deliverable	_____	Nominal Deliverable	_____
<u>Total SM/RCS Propellant Load (lb)</u>			
Total fuel	_____ ±1.4	Total Oxidizer	_____ ±4.6
Maximum Trapped	<u>8.4</u>	Maximum Trapped	<u>18.0</u>
Nominal Deliverable	_____	Nominal Deliverable	_____



TABLE 3.5-16

Amendment 94
12/10/70

LM-10 CONSUMABLE LOADING REQUIREMENTS

LM-10 APS PROPELLANT

	<u>Fuel (lb)</u>	<u>Oxidizer (lb)</u>
Propellant Load	<u>2008.6</u>	<u>3225.8</u>
Trapped Outside Tanks	<u>5.9</u>	<u>8.3</u>
Tanked	<u>2002.7</u>	<u>3217.5</u>
Trapped Inside Tsns	<u>10.1</u>	<u>27.6</u>
Nominal Deliverable	<u>1992.6</u>	<u>3189.9</u>
Outage	<u>TBD</u>	<u>TBD</u>
Total APS Propellant	<u>TBD</u>	<u>TBD</u>

The following table should be used to determine the amount of propellant to be off-loaded from a full condition to arrive at the indicated load. The allowable tolerance for the calculated off-load is ±0.5 pounds per weigh tank.

A. Final tank pressure at overfill (PSIG)	_____	_____
B. Propellant loading temperature (°F)	_____	_____
C. Nominal overfill quantity (lb)	<u>TBD</u>	<u>TBD</u>
D. Correction for tank pressure (lb)	_____	_____
Fuel = 0.09 (Item A-40)		
Oxidizer = 0.15 (Item A-40)		
¹ E. Correction for loading temperature (lb)	_____	_____
Fuel = 1.16 (Item B-65)		
Oxidizer = -2.84 (Item B-65)		
² F. Measured density (GM/CC)	_____	_____
² G. Nominal density (GM/CC)	<u>0.8994</u>	<u>1.4824</u>
H. Delta density (GM/CC) (Item F-G)	_____	_____
³ I. Correction for measured density	_____	_____
Fuel = 2300 (Item H)		
Oxidizer = 2300 (Item H)		
J. Propellant in GSE	_____	_____
K. Overfill quantity (C+D+E+I+J)	_____	_____
L. Target loading	<u>2008.6</u>	<u>3225.8</u>
M. Quantity required to fill RCS manifolds	<u>10.0</u>	<u>15.8</u>
N. Quantity to be off-loaded (Item K-L-M)	_____	_____

NOTES:

¹Loading temperature correction will always be negative.

²To calculate the nominal density solve the following equation where T = temperature in °C of the measured density (usually 4°C for oxidizer and 25°C for fuel). This equation is valid for 14.7 PSIA. Therefore, the measured density must also be at 14.7 PSIA.

Nominal fuel density = 0.922904-0.0009377 (°C)
Nominal oxidizer density = 1.491539-0.0022832 (°C)

³Correction for measured density may be either positive or negative.



TABLE 3.5-16 (Continued)
LM-10 CONSUMABLE LOADING REQUIREMENTS

LM-10 DPS PROPELLANT

	<u>Fuel (lb)</u>	<u>Oxidizer (lb)</u>
Propellant Load	<u>7538.7</u>	<u>12046.7</u>
Trapped Outside Tanks	<u>27.7</u>	<u>49.2</u>
Tanked	<u>7511.0</u>	<u>11997.5</u>
Trapped Inside Tanks	<u>19.2</u>	<u>40.9</u>
Nominal Deliverable	<u>7491.8</u>	<u>11956.6</u>
Outage	<u>TBD</u>	<u>TBD</u>
Total DPS Propellant	<u>TBD</u>	<u>TBD</u>

The following table should be used to determine the amount of propellant to be off-loaded from a full condition to arrive at the indicated load. The allowable tolerance for the calculated off-load is ±0.5 pounds per weigh tank.

A1. Final tank pressure at overfill (PSIG)	_____	_____
B1. Propellant loading temperature (°F)	_____	_____
C1. Nominal overfill quantity (lb)	<u>TBD</u>	<u>TBD</u>
D1. Correction for tank pressure (lb)	_____	_____
Fuel = TBD		
Oxidizer = TBD		
¹ E1. Correction for loading temperature (lb)	_____	_____
Fuel = TBD		
Oxidizer = TBD		
² F1. Measured density (GM/CC)	_____	_____
² G1. Nominal density (GM/CC)	<u>0.8994</u>	<u>1.4824</u>
H1. Delta density (GM/CC) (Item F1-Item G1)	_____	_____
³ I1. Correction for measured density	_____	_____
Fuel = TBD		
Oxidizer = TBD		
J1. Propellant in GSE	_____	_____
K1. Overfill quantity (C1+D1+E1+I1+J1)	_____	_____
L1. Target loading	<u>7538.7</u>	<u>12046.7</u>
M1. Quantity required to fill RCS manifolds (APS only)	<u>xxxxxxx</u>	<u>xxxxxxx</u>
N1. Quantity to be off-loaded (Items K1-L1-M1)	_____	_____

NOTES:

¹Loading temperature correction will always be negative.

²To calculate the nominal density solve the following equation where
T = temperature in °C of the measured density (usually 4°C for oxidizer and 25°C for fuel). This equation is valid for 14.7 PSIA. Therefore, the measured density must also be at 14.7 PSIA.

Nominal fuel density = 0.922904-0.0009377 (°C)

Nominal oxidizer density = 1.491539-0.0022832 (°C)

³Correction for measured density may be either positive or negative.

TABLE 3.5-16 (Continued)
LM-10 - RCS PROPELLANT (2) (3)

	Required	Ullage Requirement (in ³)		Actual ⁵	Actual ⁴
	Load (lb) ⁵	Minimum ⁴	Maximum ⁴	Load (lb)	Ullage (in ³)
System A Fuel	107.7±0.9	152.5	164.5		
System A Oxidizer	208.8±1.9	267.0	279.0		
System B Fuel	107.7±0.9	152.5	164.5		
System B Oxidizer	208.8±1.9	267.0	279.0		

	FUEL	OXIDIZER
Propellant Load	215.4	417.6
Trapped Outside Tanks	10.3	16.2
Tanked	205.1	401.4
Trapped in Tanks	4.2	8.0
Nominal Deliverable	200.9	393.4

LM-10 - Helium & Nitrogen

Consumable	Nominal Loading Requirement			Actual		
	Pressure (PSIA)	Temp (°F)	Weight (lb)	Pressure (PSIA)	Temp (°F)	Weight (lb)
Helium - APS tank #1 (6)	3050	70	6.6			
- APS tank #2 (6)	3050	70	6.6			
- RCS tank #1 (6)	3050	70	1.05			
- RCS tank #2 (6)	3050	70	1.05			
- DPS (SHe)	80±2	N/A	48.5			
- DPS (Ambient)(6)	1600	70	1.1			
Nitrogen - Ascent			0.1			
- Descent			0.6			

LM-10 - Water & GOX

Consumable	Nominal Loading Requirement		Actual	
	Pressure (PSIA)	Weight (lb)	Pressure (PSIA)	Weight (lb)
Ascent Water - tank #1	N/A	42.5	N/A	
- tank #2	N/A	42.5	N/A	
Descent Water - tank #1	N/A	(7)	N/A	
- tank #2	N/A	(7)	N/A	
Ascent GOX - tank #1 (6)	830	2.4		
- tank #2 (6)	830	2.4		
Descent GOX - tank #1 (6)	2700	48.0		
- tank #2 (6)	2700	48.0		

NOTES:

- ¹See Table 3.5-17 for actual propellant load calculation.
- ²See Section 5.6 for explanation of trapped propellants.
- ³See Table 3.5-18 for loading uncertainties.
- ⁴PV ullage calculation should be 158.5±50 cubic inches for LM/RCS fuel and 273±50 cubic inches for LM/RCS oxidizer per tank.
- ⁵LM/RCS required load includes propellant required to fill RCS manifolds to isolation valves. See Table 3.5-16. See Section 5.6 for trapped propellants.
- ⁶The indicated items should be loaded in accordance with loading windows contained in the CSM/LM Spacecraft Operational Data Book, Volume II, Part 2, SNA-8-D-027PT2.
- ⁷LM-10 Descent Water shall be loaded to provide 365-0.0±10.0 pounds at Earth Launch. Initial load will be determined by sampling requirements.



TABLE 3.5-17
LOAD CALCULATION

	<u>Fuel</u>	<u>Oxidiser</u>
<u>APS PROPELLANT</u>		
1. Full tank - Item K, Table 3.5-16 (lb)	_____	_____
12. Density of off-load tables at loading temperature and pressure (lb/ft ³)	_____	_____
13. Propellant volume (divide item 1 by item 2. (ft ³))	_____	_____
14. Measured density (from Table 3.5-19 (lb/ft ³))	_____	_____
5. Resulting full tank load (lb)	_____	_____
6. Off-load amount (lb)	_____	_____
7. Propellant required to fill RCS manifolds (lb)	_____	_____
8. Propellant load (lb)	_____	_____
<u>DPS PROPELLANT</u>		
9. Full tank - Item K1 Table 3.5-16 (lb)	_____	_____
10. Density of off-load tables at loading temperature and pressure (lb/ft ³)	_____	_____
11. Propellant volume (divide Item 9 by Item 10)(ft ³)	_____	_____
12. Measured density (from Table 3.5-19) (lb/ft ³)	_____	_____
13. Resulting full tank load (lb)	_____	_____
14. Off-load amount (lb)	_____	_____
15. Propellant load (lb)	_____	_____

	<u>Fuel</u>		<u>Oxidiser</u>	
	<u>Tank A</u>	<u>Tank B</u>	<u>Tank A</u>	<u>Tank B</u>
<u>RCS PROPELLANT</u>				
P. V. Calculations				
A. GSE Volume (in ³)	_____	_____	_____	_____
B. Initial Ullage Pressure (PSIG)	_____	_____	_____	_____
C. Initial GSE Pressure (PSIG)	_____	_____	_____	_____
D. Final GSE - S/C Pressure (PSIG)	_____	_____	_____	_____
E. Ullage Volume (in ³) - Solve the following equation by substituting the values in the indicated steps.	_____	_____	_____	_____
Ullage Volume = $\frac{(D-C)(A)}{B-D}$				

NOTE: ¹ These items will be completed only if a density sample is not made prior to loading. If a density sample is made prior to loading, then the items will be left blank.



TABLE 3.5-18

LM-10 PROPELLANT LOADING UNCERTAINTIES

LM-10 APS PROPELLANT

	<u>Fuel (lb)</u>	<u>Oxidizer (lb)</u>
Vent Line Volume	<u>±0.2</u>	<u>±0.3</u>
Tank Volume	<u>±0.8</u>	<u>±1.3</u>
Pressure Measurement (±5 PSIA)	<u>±0.5</u>	<u>±0.8</u>
Temperature Measurement (±1.5°F)	<u>±1.7</u>	<u>±4.3</u>
Measured Density	<u>±0.7</u>	<u>±0.5</u>
² Weight Measurement	<u>±0.5</u>	<u>±0.5</u>
¹ Loading Tolerance	<u>±0.5</u>	<u>±0.5</u>
Total Loading Uncertainty	<u>±4.8</u>	<u>±8.2</u>

APS Mission Uncertainties

Mixture Ratio Variation	<u>TBD</u>
$\Delta V, I_{sp}$, Vehicle Weight Variation	<u>TBD</u>
Propellant Usage Uncertainty Due To Total Loading Uncertainty	<u>TBD</u>
Total Propellant Uncertainty For Mission ΔV	<u>TBD</u>

LM-10 DPS PROPELLANT

Vent Line Volume	<u>±0.2</u>	<u>±0.3</u>
Tank Volume	<u>±3.62</u>	<u>±5.96</u>
Pressure Measurement (±5 PSIA)	<u>±1.70</u>	<u>±2.77</u>
Temperature Measurement (1.5°F)	<u>±6.49</u>	<u>±15.76</u>
Measured Density	<u>±2.55</u>	<u>±1.70</u>
² Weight Measurement	<u>±0.5</u>	<u>±0.5</u>
¹ Loading Tolerance	<u>±0.5</u>	<u>±0.5</u>
Total Loading Uncertainty	<u>±15.6</u>	<u>±27.5</u>

DPS Mission Uncertainties

Mixture Ratio Variation	<u>TBD</u>
$\Delta V, I_{sp}$, Vehicle Weight Variation	<u>TBD</u>
Propellant Usage Uncertainty Due To Total Loading Uncertainty	<u>TBD</u>
Total Propellant Uncertainty For Mission ΔV	<u>TBD</u>

LM-10 RCS PROPELLANT

Loading Temperature	<u>±0.6</u>	<u>±1.8</u>
Ullage Calculation	<u>±0.4</u>	<u>±0.6</u>
Tank and Manifold Volume	<u>±0.8</u>	<u>±1.4</u>
Total	<u>±1.8</u>	<u>±3.8</u>

¹These will be known quantities after loading is accomplished.

²If weigh tank is used for off-loading, then weight measurement uncertainty is ±0.5 pounds per weigh tank. If flow meter is used for off-loading, then weight measurement uncertainty is ±4.0% of amount off-loaded.

U U U E L E L L E E E E E H H K K L L

TABLE 3.5-19

LM-10 APS Propellant Loading Parameters
(To Be Completed by NSC at Loading)

	<u>Fuel</u>	<u>Oxidizer</u>
Loading Pressure - PSIA	_____	_____
Loading Temperature - Fill Line - Degrees F	_____	_____
<div style="display: flex; align-items: center;"> <div style="flex: 1;"> TT 58 Fuel TT258 Oxidizer </div> <div style="margin-left: 10px;"> _____ _____ </div> </div>		
Loading Temperature - Return Line - Degrees F	_____	_____
<div style="display: flex; align-items: center;"> <div style="flex: 1;"> TT 59 Fuel TT259 Oxidizer </div> <div style="margin-left: 10px;"> _____ _____ </div> </div>		
Loading Temperature - Tank - Degrees F	_____	_____
<div style="display: flex; align-items: center;"> <div style="flex: 1;"> GP0718 Fuel GP1218 Oxidizer </div> <div style="margin-left: 10px;"> _____ _____ </div> </div>		
Number of Times Weigh Tank Used (Flow Meter Not Used)	_____	_____
Total Pounds Off-Loaded Using Weigh Tank (Flow Meter Not Used)	_____	_____
Pounds Off-Loaded Using Flow Meter (Weigh Tank Not Used)	_____	_____
Measured Fuel Density @ °C; @ PSIA GM/CC	_____	_____
Measured Oxidizer Density @ °C; @ PSIA GM/CC	_____	_____

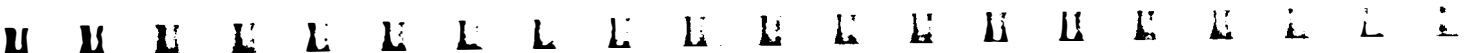

TABLE 3.5-19 (Continued)
LM-10 DPS Propellant Loading Parameters

	<u>Fuel</u>	<u>Oxidizer</u>
Loading Pressure - PSIA	_____	_____
Loading Temperature - Fill Line - Degrees F	TT 58 Fuel TT258 Oxidizer	_____
Loading Temperature - Return Line - Degrees F	TT 59 Fuel TT259 Oxidizer	_____
Loading Temperature - Tank One - Degrees F	GQ3718 Fuel GQ4218 Oxidizer	_____
Loading Temperature - Tank Two - Degrees F	GQ3719 Fuel GQ4219 Oxidizer	_____
Number of Times Weigh Tank Used (Flow Meter Not Used)	_____	_____
Total Pounds Off-Loaded Using Weigh Tank (Flow Meter Not Used)	_____	_____
Pounds Off-Loaded Using Flow Meter (Weigh Tank Not Used)	_____	_____
Measured Fuel Density @ °C; PSIA GM/CC	_____	_____
Measured Oxidizer Density @ °C; PSIA GM/CC	_____	_____



MISSION J-1 MASS PROPERTY DATA TABLES

- Table 3.5-20 presents the CSM-112/LM-10 (docked) mass properties, in Apollo coordinates, as a function of spacecraft weight for L.O.I. SM/SPS burn.
- Table 3.5-21 presents the CSM-112/LM-10 (docked) mass properties, in Apollo coordinates, as a function of spacecraft weight for the D.O.I. SM/SPS burn.
- Table 3.5-22 presents the CSM-112 mass properties, in Apollo coordinates, as a function of CSM weight for the Circularization I SM/SPS burn.
- Table 3.5-23 presents the CSM-112 mass properties, in Apollo coordinates, as a function of CSM weight for the Plane Change I SM/SPS burn.
- Table 3.5-24 presents the CSM-112 mass properties, in Apollo coordinates, as a function of CSM weight for the T.E.I. SM/SPS burn.
- Table 3.5-25 presents the LM-10 mass properties, in LM coordinates, as a function of LM weight for the P.D.I. DPS burn.
- Table 3.5-26 presents the LM-10 ascent stage mass properties, in LM coordinates, as a function of weight for the lunar liftoff APS burn.
- Table 3.5-27 presents the LM-10 mass properties, in LM coordinates, as a function of LM weight for the T.P.I. to docking LM/RCS burn.



X(A) COORDINATES

TABLE 3.5-20

CSM-112/ LM-10 L.O.L. BURN

WEIGHT LBS.	X-BAR	Y-BAR INCHES	Z-BAR	IXX	IYY	IZZ SLUG-FT SQ	PXY	PXZ	PLY	PITCH DEGREES	YAW DEGREES	AVERAGE MOMENT	INERTIA/THRUST RATIO
102816.5	1041.21	3.06	3.34	61980	574801	577762	-10979	-5346	2140	1.229	-.107	576281	1.573
101816.5	1041.96	3.06	3.27	61455	573086	576482	-10974	-5220	1994	1.253	-.111	574784	1.563
100816.5	1042.79	3.05	3.19	60931	571074	574906	-10968	-5079	1849	1.278	-.115	572990	1.552
99816.5	1043.72	3.05	3.11	60405	568739	573006	-10961	-4922	1704	1.303	-.120	570872	1.540
98816.5	1044.75	3.05	3.03	59880	566051	570754	-10953	-4748	1559	1.329	-.125	568402	1.526
97816.5	1045.86	3.04	2.95	59354	562978	568116	-10945	-4558	1414	1.355	-.130	565547	1.510
96816.5	1047.08	3.04	2.87	58829	559486	565061	-10935	-4351	1268	1.382	-.136	562274	1.493
95816.5	1048.40	3.04	2.78	58302	555542	561554	-10925	-4127	1123	1.409	-.142	558548	1.474
94816.5	1049.83	3.03	2.70	57776	551106	557555	-10914	-3885	978	1.437	-.148	554331	1.453
93816.5	1051.36	3.03	2.61	57249	546140	553026	-10902	-3624	833	1.466	-.155	549583	1.430
92816.5	1053.00	3.02	2.52	56722	540601	547925	-10890	-3343	687	1.494	-.162	544263	1.406
91816.5	1054.77	3.02	2.42	56194	534445	542206	-10876	-3043	542	1.523	-.169	538325	1.380
90816.5	1056.65	3.01	2.33	55666	527623	535823	-10861	-2722	397	1.553	-.177	531723	1.351
89816.5	1058.65	3.01	2.23	55138	520087	528725	-10845	-2380	252	1.583	-.185	524406	1.321
88816.5	1060.79	3.01	2.13	54610	511782	520859	-10828	-2016	106	1.613	-.193	516320	1.288
87816.5	1063.05	3.00	2.03	54081	502648	512165	-10810	-1628	-38	1.644	-.202	507406	1.253
86816.5	1065.45	3.00	1.93	53551	492691	502647	-10792	-1219	-184	1.675	-.211	497669	1.217
85816.5	1068.00	2.99	1.82	53021	481724	492121	-10772	-784	-329	1.706	-.220	486922	1.177
84816.5	1069.95	2.94	1.77	52506	474580	484980	-10681	-562	-436	1.722	-.238	479780	1.151
83816.5	1071.15	2.84	1.77	52005	472405	482322	-10503	-567	-501	1.723	-.266	477364	1.139
82816.5	1072.47	2.74	1.78	51505	469823	479258	-10307	-574	-566	1.725	-.293	474541	1.126
81816.5	1073.89	2.64	1.78	51004	466845	475796	-10095	-580	-630	1.727	-.322	471321	1.112
80816.5	1075.43	2.53	1.78	50502	463472	471939	-9865	-587	-695	1.729	-.351	467705	1.096
79816.5	1077.08	2.43	1.78	50000	459695	467679	-9619	-595	-760	1.731	-.380	463687	1.080
78816.5	1078.84	2.32	1.79	49498	455500	462999	-9356	-603	-824	1.733	-.410	459250	1.062
77816.5	1080.71	2.20	1.79	48995	450864	457878	-9075	-612	-889	1.735	-.440	454371	1.042
76816.5	1082.70	2.09	1.79	48492	445756	452285	-8777	-621	-953	1.738	-.471	449020	1.022
75816.5	1084.82	1.97	1.80	47989	440137	446180	-8460	-630	-1018	1.741	-.502	443159	1.000
74816.5	1087.07	1.84	1.80	47485	433966	439523	-8123	-641	-1083	1.743	-.534	436744	.977
73816.5	1089.46	1.72	1.81	46980	427193	432263	-7766	-652	-1147	1.746	-.566	429728	.952
72816.5	1092.00	1.59	1.81	46475	419766	424349	-7387	-663	-1212	1.749	-.598	422057	.926
71816.5	1094.69	1.46	1.81	45969	411631	415726	-6984	-676	-1276	1.753	-.631	413678	.898
70816.5	1097.54	1.32	1.82	45463	402730	406337	-6556	-689	-1341	1.756	-.664	404534	.869
69816.5	1100.56	1.18	1.82	44956	393010	396128	-6103	-702	-1405	1.760	-.698	394569	.838
68816.5	1103.76	1.03	1.83	44449	382416	385044	-5623	-717	-1470	1.763	-.731	383730	.805
67816.5	1107.14	.88	1.83	43941	370902	373040	-5115	-732	-1534	1.767	-.765	371971	.771
66816.5	1110.71	.73	1.84	43432	358428	360075	-4578	-748	-1599	1.771	-.799	359251	.735

X(A) COORDINATES

TABLE 3.5-20 (CONTINUED)

CSM-112/ LM-10 L.O.I. BURN

WEIGHT LBS.	X-BAR	Y-BAR INCHES	Z-BAR	IXX	IYY	IZZ SLUG-FT SQ	PXY	PXZ	PYZ	PITCH DEGREES	YAW	AVERAGE MOMENT	INERTIA/THRUST RATIO
65816.5	1114.49	.57	1.84	42923	344913	346069	-4017	-766	-1663	1.775	-.834	345491	.697
64816.5	1118.47	.41	1.85	42413	330297	330960	-3415	-783	-1728	1.779	-.868	330628	.658
63816.5	1122.68	.24	1.85	41902	314497	314667	-2783	-802	-1792	1.784	-.902	314582	.617
62816.5	1127.14	.07	1.86	41390	297243	296920	-2111	-822	-1856	1.788	-.937	297081	.574

X(A) COORDINATES

TABLE 3.5-21

CSM-112/ LM-10 0.0.1. BURN

WEIGHT LBS.	X-BAR	Y-BAR INCHES	Z-BAR	IXX	IYY	IZZ SLUG-FT SQ	PXY	PXZ	PYZ	PITCH DEGREES	YAW DEGREES	AVERAGE MOMENT	INERTIA/THRUST RATIO
102763.6	1041.29	3.06	3.34	61930	574724	577692 -10988	-5346	2152	1.229	-.107	576208	1.572	
101763.6	1042.03	3.06	3.27	61405	573007	576410 -10983	-5220	2007	1.253	-.111	574709	1.563	
100763.6	1042.87	3.06	3.19	60880	570993	574831 -10977	-5079	1862	1.278	-.115	572912	1.551	
99763.6	1043.80	3.05	3.11	60355	568655	572928 -10970	-4921	1717	1.303	-.120	570791	1.539	
98763.6	1044.83	3.05	3.03	59830	565962	570672 -10962	-4748	1572	1.329	-.125	568317	1.525	
97763.6	1045.95	3.05	2.95	59304	562885	568031 -10954	-4558	1427	1.355	-.130	565458	1.509	
96763.6	1047.17	3.04	2.87	58778	559390	564972 -10945	-4351	1281	1.382	-.136	562181	1.492	
95763.6	1048.49	3.04	2.78	58252	555441	561459 -10934	-4126	1136	1.409	-.142	558450	1.473	
94763.6	1049.91	3.03	2.70	57726	551000	557456 -10923	-3884	991	1.437	-.148	554228	1.452	
93763.6	1051.45	3.03	2.61	57199	546029	552922 -10912	-3622	846	1.466	-.155	549475	1.430	
92763.6	1053.09	3.03	2.52	56672	540484	547814 -10899	-3342	700	1.494	-.162	544149	1.405	
91763.6	1054.86	3.02	2.42	56144	534321	542089 -10885	-3042	555	1.524	-.169	538205	1.379	
90763.6	1056.74	3.02	2.33	55616	527493	535699 -10870	-2721	410	1.553	-.177	531596	1.350	
89763.6	1058.75	3.01	2.23	55088	519949	528594 -10855	-2378	264	1.583	-.185	524271	1.320	
88763.6	1060.88	3.01	2.13	54559	511636	520720 -10838	-2014	119	1.613	-.193	516178	1.287	
87763.6	1063.16	3.00	2.03	54030	502494	512017 -10820	-1626	-25	1.644	-.202	507255	1.253	
86763.6	1065.56	3.00	1.93	53501	492527	502490 -10801	-1217	-171	1.675	-.211	497508	1.216	
85763.6	1068.11	2.99	1.82	52971	481550	491953 -10781	-781	-316	1.706	-.220	486752	1.177	
84763.6	1070.06	2.94	1.77	52456	474399	484805 -10691	-559	-423	1.722	-.238	479602	1.150	
83763.6	1071.26	2.84	1.77	51955	472218	482142 -10513	-565	-488	1.723	-.265	477180	1.138	
82763.6	1072.58	2.74	1.78	51455	469632	479073 -10317	-571	-553	1.725	-.293	474352	1.125	
81763.6	1074.01	2.64	1.78	50953	466647	475606 -10104	-578	-617	1.727	-.322	471127	1.111	
80763.6	1075.55	2.54	1.78	50452	463267	471742 -9874	-585	-682	1.729	-.350	467505	1.095	
79763.6	1077.20	2.43	1.78	49950	459484	467475 -9627	-592	-747	1.731	-.380	463479	1.079	
78763.6	1078.96	2.32	1.79	49448	455282	462788 -9364	-600	-811	1.733	-.410	459035	1.061	
77763.6	1080.84	2.20	1.79	48945	450638	457659 -9084	-609	-876	1.736	-.440	454148	1.041	
76763.6	1082.83	2.09	1.79	48442	445521	452056 -8785	-618	-940	1.738	-.471	448788	1.021	
75763.6	1084.96	1.97	1.80	47939	439893	445943 -8468	-628	-1005	1.741	-.502	442913	.999	
74763.6	1087.21	1.84	1.80	47435	433712	439276 -8131	-638	-1070	1.744	-.534	436494	.976	
73763.6	1089.60	1.72	1.81	46930	426929	432006 -7774	-649	-1134	1.746	-.566	429467	.951	
72763.6	1092.14	1.59	1.81	46425	419490	424080 -7394	-661	-1199	1.750	-.598	421785	.925	
71763.6	1094.83	1.46	1.81	45919	411343	415445 -6991	-673	-1263	1.753	-.631	413394	.897	
70763.6	1097.69	1.32	1.82	45413	402429	406043 -6563	-686	-1328	1.756	-.664	404236	.868	
69763.6	1100.71	1.18	1.82	44906	392695	395820 -6110	-700	-1392	1.760	-.698	394257	.837	
68763.6	1103.92	1.03	1.83	44399	382086	384721 -5629	-714	-1457	1.763	-.731	383404	.804	
67763.6	1107.31	.88	1.83	43891	370555	372701 -5121	-730	-1521	1.767	-.765	371623	.770	
66763.6	1110.88	.73	1.84	43382	358064	359718 -4584	-746	-1586	1.771	-.799	358891	.734	

X(A) COORDINATES

TABLE 3.5-21 (CONTINUED)

CSM-112/ LM-10 D.O.I. BURN

WEIGHT LBS.	X-BAR	Y-BAR INCHES	Z-BAR	IXX	IYY	IZZ SLUG-FT SQ	PXY	PXZ	PYZ	PITCH DEGREES	YAW	AVERAGE MOMENT	INERTIA/THRUST RATIO
65763.6	1114.66	.57	1.84	42873	344531	345694	-4022	-763	-1650	1.775	-0.834	345112	.696
64763.6	1118.65	.41	1.85	42363	329894	330564	-3420	-781	-1715	1.780	-0.868	330229	.657
63763.6	1122.86	.24	1.85	41852	314072	314250	-2787	-800	-1779	1.784	-0.902	314161	.616
62763.6	1127.34	.07	1.86	41340	296795	296479	-2115	-820	-1843	1.789	-0.937	296637	.573

X(A) COORDINATES

TABLE 3.5-22

CSM-112 CIRCULARIZATION BURN

WEIGHT LBS.	X-BAR	Y-BAR INCHES	Z-BAR	IXX	IYY	IZZ SLUG-FT SQ	PXY	PXZ	PYZ	PITCH DEGREES	YAW	AVERAGE MOMENT	INERTIA/THRUST RATIO
65871.0	933.24	4.93	4.85	35513	78541	80504 -2234		531	2548	-.625	1.870	79523	.451
64871.0	932.75	4.95	4.75	34993	77869	80261 -2224		486	2405	-.584	1.897	79065	.451
63871.0	932.36	4.97	4.66	34472	77279	80102 -2216		451	2263	-.538	1.922	78690	.451
62871.0	932.08	5.00	4.55	33951	76753	80006 -2210		425	2120	-.487	1.944	78380	.450
61871.0	931.91	5.02	4.45	33429	76271	79955 -2207		409	1973	-.431	1.964	78113	.449
60871.0	931.85	5.05	4.34	32908	75811	79926 -2206		403	1836	-.370	1.981	77869	.448
59871.0	931.92	5.08	4.23	32385	75353	79899 -2208		408	1694	-.303	1.995	77626	.447
58871.0	932.11	5.11	4.11	31863	74872	79850 -2212		424	1552	-.232	2.006	77361	.444
57871.0	932.43	5.14	3.99	31340	74343	79753 -2219		452	1410	-.155	2.013	77048	.441
56871.0	932.90	5.17	3.87	30817	73739	79582 -2229		492	1268	-.073	2.016	76660	.437
55871.0	933.51	5.20	3.74	30293	73033	79308 -2243		545	1126	.013	2.016	76170	.431
54871.0	934.28	5.23	3.61	29769	72192	78900 -2259		613	984	.105	2.012	75545	.424
53871.0	935.21	5.26	3.47	29245	71184	78326 -2279		695	843	.201	2.004	74755	.416
52871.0	936.32	5.30	3.33	28720	69974	77549 -2303		792	701	.301	1.992	73761	.406
51871.0	937.62	5.34	3.18	28195	68522	76532 -2331		907	560	.405	1.975	72527	.394
50871.0	939.11	5.37	3.03	27668	66782	75227 -2363		1039	419	.513	1.954	71004	.381
49871.0	940.80	5.41	2.87	27142	64731	73611 -2399		1187	277	.624	1.929	69171	.365
48871.0	942.73	5.45	2.70	26615	62276	71592 -2441		1357	136	.739	1.900	66934	.347
47871.0	943.56	5.41	2.63	26104	60717	70039 -2490		1451	32	.787	1.859	65378	.336
46871.0	943.01	5.29	2.65	25611	60621	69468 -2525		1457	-31	.768	1.809	65044	.336
45871.0	942.60	5.16	2.67	25117	60557	68928 -2552		1462	-94	.750	1.753	64742	.336
44871.0	942.30	5.03	2.70	24623	60520	68416 -2570		1465	-158	.733	1.690	64469	.336
43871.0	942.14	4.89	2.73	24129	60504	67925 -2582		1466	-222	.717	1.621	64214	.335
42871.0	942.09	4.75	2.75	23635	60503	67447 -2585		1467	-285	.701	1.545	63975	.334
41871.0	942.18	4.59	2.78	23140	60505	66973 -2581		1466	-349	.687	1.463	63739	.332
40871.0	942.40	4.43	2.81	22644	60499	66490 -2569		1463	-412	.674	1.374	63494	.330
39871.0	942.78	4.26	2.85	22148	60470	65983 -2548		1459	-475	.662	1.278	63226	.328
38871.0	943.31	4.09	2.88	21652	60400	65435 -2518		1452	-538	.652	1.175	62918	.324
37871.0	944.02	3.90	2.92	21155	60269	64826 -2478		1444	-601	.643	1.066	62547	.320
36871.0	944.92	3.70	2.95	20657	60053	64131 -2426		1434	-664	.636	.949	62092	.316
35871.0	946.04	3.50	2.99	20159	59725	63324 -2361		1421	-727	.630	.825	61525	.310
34871.0	947.39	3.28	3.04	19659	59257	62375 -2282		1405	-790	.627	.694	60816	.302
33871.0	949.00	3.04	3.08	19160	58617	61254 -2187		1387	-852	.626	.556	59935	.294
32871.0	950.90	2.80	3.13	18659	57769	59924 -2076		1365	-914	.629	.412	58847	.284
31871.0	953.11	2.54	3.18	18157	56679	58351 -1945		1340	-977	.632	.262	57515	.272
30871.0	955.66	2.26	3.23	17654	55308	56496 -1794		1311	-1039	.638	.106	55902	.259
29871.0	958.58	1.96	3.29	17150	53620	54324 -1621		1277	-1100	.647	-.055	53972	.244

X(A) COORDINATES

TABLE 3.5-22 (CONTINUED) CSM-112 CIRCULARIZATION BURN

WEIGHT LbS.	X-BAR	Y-BAR INCHES	Z-BAR	IXX	IYY	IZZ SLUG-FT SQ	PXY	PXZ	PYZ	PITCH DEGREES	YAW	AVERAGE MOMENT	INERTIA/THRUST RATIO
28871.0	961.92	1.64	3.35	16645	51557	51775	-1429	1239	-1162	.659	-.219	51666	.228
27871.0	965.71	1.30	3.42	16139	49057	48787	-1201	1196	-1223	.673	-.388	48922	.210
26871.0	970.01	.93	3.49	15631	46052	45294	-946	1147	-1284	.690	-.559	45673	.190
25871.0	974.96	.54	3.56	15121	42401	41152	-652	1091	-1345	.711	-.732	41776	.167

X(A) COORDINATES

TABLE 3.5-23

CSM-112 PLANE CHANGE .1

WEIGHT LBS.	X-BAR	Y-BAR INCHES	Z-BAR	IXX	IYY	IZZ SLUG-FT SQ	PXY	PXZ	PYZ	PITCH DEGREES	YAW	AVERAGE MOMENT	INERTIA/THRUST RATIO
65494.7	933.29	4.95	4.90	35218	78262	80308	-2230	499	2633	-.652	1.881	79285	.450
64494.7	932.79	4.97	4.80	34698	77590	80067	-2220	455	2490	-.611	1.909	78828	.449
63494.7	932.40	5.00	4.70	34177	77001	79907	-2211	420	2348	-.565	1.934	78454	.449
62494.7	932.12	5.02	4.60	33656	76475	79812	-2206	394	2206	-.515	1.957	78144	.449
61494.7	931.95	5.05	4.50	33135	75993	79761	-2202	378	2063	-.459	1.977	77877	.448
60494.7	931.89	5.08	4.39	32613	75534	79733	-2201	372	1921	-.398	1.995	77633	.447
59494.7	931.96	5.10	4.28	32091	75075	79705	-2203	377	1779	-.331	2.009	77390	.445
58494.7	932.15	5.13	4.16	31569	74594	79656	-2208	393	1637	-.260	2.020	77125	.443
57494.7	932.48	5.16	4.04	31046	74065	79558	-2215	421	1495	-.183	2.027	76812	.439
56494.7	932.95	5.19	3.92	30523	73461	79387	-2225	461	1353	-.101	2.031	76424	.435
55494.7	933.56	5.23	3.79	30000	72754	79112	-2239	514	1211	-.014	2.031	75933	.430
54494.7	934.34	5.26	3.66	29476	71912	78703	-2255	581	1070	.078	2.027	75308	.423
53494.7	935.28	5.29	3.52	28951	70903	78128	-2276	663	928	.174	2.019	74515	.414
52494.7	936.40	5.33	3.38	28427	69691	77349	-2300	760	787	.275	2.007	73520	.405
51494.7	937.71	5.37	3.23	27901	68237	76329	-2328	873	645	.379	1.990	72283	.393
50494.7	939.21	5.41	3.08	27375	66494	75021	-2361	1005	504	.488	1.969	70757	.379
49494.7	940.92	5.45	2.92	26849	64439	73401	-2398	1152	363	.600	1.944	68920	.363
48494.7	942.87	5.49	2.75	26322	61979	71377	-2440	1321	222	.715	1.915	66678	.345
47494.7	943.70	5.45	2.67	25811	60418	69821	-2489	1416	118	.763	1.873	65120	.335
46494.7	943.16	5.33	2.70	25318	60323	69251	-2524	1422	54	.744	1.823	64787	.335
45494.7	942.74	5.20	2.73	24825	60260	68713	-2551	1426	-9	.725	1.767	64487	.334
44494.7	942.45	5.07	2.75	24331	60224	68202	-2569	1430	-72	.707	1.704	64213	.334
43494.7	942.28	4.93	2.78	23837	60209	67711	-2580	1431	-136	.690	1.635	63960	.333
42494.7	942.24	4.78	2.81	23342	60207	67234	-2584	1432	-199	.674	1.559	63720	.332
41494.7	942.33	4.63	2.84	22847	60209	66759	-2579	1430	-263	.659	1.477	63484	.330
40494.7	942.56	4.46	2.87	22352	60203	66276	-2567	1428	-326	.645	1.388	63239	.328
39494.7	942.94	4.30	2.91	21856	60172	65768	-2546	1423	-389	.632	1.291	62970	.326
38494.7	943.49	4.12	2.94	21359	60101	65219	-2516	1416	-452	.621	1.188	62660	.323
37494.7	944.21	3.93	2.98	20862	59968	64607	-2475	1408	-515	.611	1.077	62287	.319
36494.7	945.12	3.73	3.02	20365	59749	63909	-2423	1397	-578	.603	.960	61829	.314
35494.7	946.26	3.52	3.06	19867	59418	63099	-2358	1383	-640	.597	.835	61258	.308
34494.7	947.63	3.30	3.11	19367	58945	62146	-2279	1367	-703	.594	.703	60545	.300
33494.7	949.27	3.07	3.16	18868	58298	61018	-2185	1347	-765	.592	.564	59658	.292
32494.7	951.20	2.82	3.21	18367	57443	59681	-2073	1324	-828	.593	.419	58562	.282
31494.7	953.44	2.55	3.26	17865	56343	58098	-1942	1298	-890	.597	.267	57220	.270
30494.7	956.04	2.27	3.32	17362	54959	56232	-1791	1267	-951	.603	.110	55596	.257
29494.7	959.01	1.97	3.38	16859	53256	54043	-1617	1242	-1013	.612	-.052	53650	.242

X(A) COORDINATES

TABLE 3.5-23 (CONTINUED)

CSM-112 PLANE CHANGE 1

WEIGHT LBS.	X-BAR	Y-BAR INCHES	Z-BAR	IXX	IYY	IZZ SLUG-FT SQ	PXY	PXZ	PYZ	PITCH DEGREES	YAW	AVERAGE MOMENT	INERTIA/THRUST RATIO
28494.7	962.40	1.65	3.44	16353	51174	51476	-1424	1191	-1074	.624	-.218	51325	.226
27494.7	966.26	1.31	3.51	15847	48649	48464	-1195	1146	-1135	.638	-.388	48556	.207
26494.7	970.64	.93	3.59	15339	45614	44940	-939	1094	-1196	.655	-.561	45277	.187
25494.7	975.69	.53	3.67	14829	41924	40760	-644	1035	-1257	.675	-.736	41342	.165

X(A) COORDINATES

TABLE 3.5-24

CSM-112 T.E.I. BURN

WEIGHT LBS.	X-BAR	Y-BAR INCHES	Z-BAR	I _{XX}	I _{YY}	I _{ZZ} SLUG-FT SQ	PXY	PXZ	PYZ	PITCH DEGREES	YAW	AVERAGE MOMENT	INERTIA/THRUST RATIO
65621.0	933.75	5.09	4.78	35047	78211	80257	-2086	379	2676	-.570	1.950	79234	.447
64621.0	933.27	5.12	4.68	34526	77545	80022	-2075	334	2533	-.528	1.979	78784	.447
63621.0	932.89	5.15	4.58	34005	76961	79868	-2066	299	2391	-.481	2.005	78414	.447
62621.0	932.61	5.17	4.48	33483	76439	79776	-2060	274	2249	-.429	2.029	78107	.446
61621.0	932.45	5.20	4.37	32962	75959	79727	-2057	258	2107	-.372	2.051	77843	.445
60621.0	932.40	5.23	4.26	32440	75500	79699	-2056	253	1965	-.310	2.069	77600	.444
59621.0	932.48	5.26	4.15	31917	75040	79671	-2058	259	1823	-.243	2.084	77355	.442
58621.0	932.68	5.29	4.03	31394	74556	79619	-2063	276	1681	-.170	2.096	77087	.440
57621.0	933.01	5.33	3.91	30871	74022	79517	-2071	305	1540	-.093	2.105	76769	.437
56621.0	933.49	5.36	3.78	30348	73411	79339	-2082	347	1398	-.010	2.109	76375	.432
55621.0	934.12	5.40	3.65	29824	72695	79056	-2097	402	1257	.077	2.110	75875	.427
54621.0	934.90	5.43	3.52	29299	71843	78637	-2116	471	1115	.169	2.107	75240	.420
53621.0	935.85	5.47	3.38	28774	70821	78048	-2139	555	974	.265	2.100	74435	.412
52621.0	936.98	5.51	3.23	28249	69593	77255	-2165	655	833	.366	2.088	73424	.402
51621.0	938.29	5.55	3.08	27723	68121	76217	-2197	772	692	.470	2.072	72169	.390
50621.0	939.81	5.59	2.92	27196	66359	74889	-2232	907	551	.579	2.052	70624	.376
49621.0	941.52	5.63	2.76	26669	64281	73248	-2273	1058	411	.690	2.028	68764	.360
48621.0	943.47	5.68	2.59	26141	61796	71199	-2320	1232	270	.804	1.999	66497	.342
47621.0	944.32	5.65	2.51	25630	60224	69632	-2370	1328	166	.854	1.959	64928	.332
46621.0	943.79	5.53	2.54	25138	60136	69070	-2403	1333	102	.836	1.912	64603	.332
45621.0	943.39	5.40	2.56	24645	60078	68537	-2428	1337	38	.820	1.858	64308	.331
44621.0	943.11	5.28	2.58	24152	60046	68030	-2445	1339	-25	.805	1.798	64038	.331
43621.0	942.96	5.14	2.61	23658	60033	67542	-2455	1340	-89	.790	1.732	63787	.330
42621.0	942.94	5.00	2.63	23164	60032	67065	-2457	1341	-152	.776	1.659	63549	.329
41621.0	943.04	4.85	2.66	22670	60033	66590	-2452	1339	-216	.764	1.580	63311	.327
40621.0	943.29	4.70	2.69	22176	60023	66104	-2440	1337	-280	.753	1.493	63064	.325
39621.0	943.69	4.54	2.71	21680	59988	65593	-2418	1332	-343	.742	1.400	62790	.323
38621.0	944.25	4.36	2.75	21185	59909	65037	-2388	1327	-407	.734	1.300	62473	.319
37621.0	944.99	4.18	2.78	20689	59767	64417	-2348	1319	-470	.726	1.193	62092	.315
36621.0	945.92	3.99	2.91	20192	59536	63708	-2296	1309	-533	.721	1.079	61622	.310
35621.0	947.07	3.79	2.85	19695	59191	62884	-2233	1297	-596	.717	.958	61038	.304
34621.0	948.47	3.58	2.89	19197	58701	61915	-2155	1283	-659	.715	.829	60308	.297
33621.0	950.12	3.36	2.93	18698	58034	60768	-2062	1266	-722	.716	.694	59401	.288
32621.0	952.07	3.12	2.97	18198	57155	59408	-1953	1246	-785	.718	.552	58282	.278
31621.0	954.33	2.86	3.02	17698	56028	57798	-1825	1223	-847	.723	.404	56913	.267
30621.0	956.94	2.59	3.07	17196	54613	55902	-1678	1196	-910	.731	.250	55257	.254
29621.0	959.93	2.30	3.12	16694	52875	53679	-1509	1166	-972	.741	.091	53277	.239

X(A) COORDINATES

TABLE 3.5-24 (CONTINUED)

CSM-112 T.E.I. BURN

WEIGHT LBS.	X-BAR	Y-BAR INCHES	Z-BAR	IXX	IYY	IZZ SLUG-FT SQ	PXY	PXZ	PYZ	PITCH DEGREES	YAW	AVERAGE MOMENT	INERTIA/THRUST RATIO
28621.0	963.35	1.99	3.17	16190	50753	51073 -1321	1130	-1034	.753	-.072	50913	.222	
27621.0	967.22	1.66	3.23	15685	48184	48018 -1099	1091	-1096	.768	-.239	48101	.204	
26621.0	971.62	1.31	3.30	15179	45099	44446 -849	1046	-1157	.786	-.409	44772	.184	
25621.0	976.68	.92	3.37	14671	41354	40211 -563	995	-1218	.806	-.582	40783	.161	

X(IE)COORDINATES

TABLE 3.5-25

LM-10 PRE P.D.I. TO TOUCHDOWN

WEIGHT LBS.	X-BAR	Y-BAR INCHES	Z-BAR	IXX	IYY	IZZ SLUG-FT	PXY SQ	PXZ	PYZ	PILOT ROLL	PILOT PITCH
										DEGREES	
36606.4	184.54	.50	-.19	27327	28662	27214	82	867	213	.944	.362
36345.2	184.70	.51	-.19	27162	28560	27150	82	867	213	.946	.363
36084.0	184.86	.51	-.20	26998	28456	27083	81	867	213	.948	.364
35822.8	185.01	.51	-.20	26834	28350	27014	80	868	213	.950	.365
35561.6	185.17	.52	-.20	26670	28241	26943	80	868	213	.953	.365
35300.4	185.32	.52	-.20	26506	28131	26870	79	868	213	.955	.366
35039.2	185.47	.53	-.20	26341	28020	26796	79	868	213	.957	.367
34778.0	185.62	.53	-.20	26177	27907	26720	78	868	213	.960	.368
34516.8	185.76	.53	-.20	26013	27792	26643	77	869	213	.963	.369
34255.6	185.91	.54	-.21	25849	27676	26564	77	869	213	.966	.370
33994.4	186.06	.54	-.21	25684	27560	26485	76	869	213	.969	.372
33733.2	186.20	.55	-.21	25520	27442	26404	76	869	213	.972	.373
33472.0	186.35	.55	-.21	25356	27323	26323	75	870	214	.975	.374
33210.8	186.50	.55	-.21	25192	27203	26240	74	870	214	.978	.375
32949.6	186.64	.56	-.21	25027	27083	26157	74	870	214	.982	.377
32688.4	186.79	.56	-.22	24863	26962	26073	73	870	214	.985	.378
32427.2	186.94	.57	-.22	24699	26840	25988	73	870	214	.988	.379
32166.0	187.09	.57	-.22	24535	26717	25903	72	871	214	.992	.380
31904.8	187.25	.58	-.22	24371	26593	25817	71	871	214	.995	.382
31643.6	187.40	.58	-.22	24206	26469	25730	71	871	214	.999	.383
31382.4	187.57	.59	-.23	24042	26344	25642	70	871	214	1.002	.384
31121.2	187.73	.59	-.23	23878	26218	25554	70	872	214	1.006	.386
30860.0	187.90	.60	-.23	23714	26092	25465	69	872	214	1.009	.387
30598.8	188.07	.60	-.23	23549	25965	25375	68	872	214	1.013	.388
30337.6	188.25	.61	-.23	23385	25836	25284	68	872	214	1.016	.390
30076.4	188.43	.61	-.24	23221	25707	25192	67	873	214	1.020	.391
29815.2	188.62	.62	-.24	23057	25577	25099	66	873	214	1.023	.392
29554.0	188.81	.62	-.24	22892	25446	25005	65	873	214	1.026	.394
29292.8	189.01	.63	-.24	22728	25314	24910	64	874	215	1.029	.395
29031.6	189.22	.63	-.24	22564	25180	24814	64	874	215	1.033	.396
28770.4	189.43	.64	-.25	22400	25045	24716	63	874	215	1.036	.397
28509.2	189.65	.65	-.25	22236	24909	24617	62	875	215	1.039	.398
28248.0	189.88	.65	-.25	22071	24771	24517	61	875	215	1.041	.400
27986.8	190.12	.66	-.25	21907	24632	24414	60	875	215	1.044	.401
27725.6	190.37	.66	-.25	21743	24491	24311	59	876	215	1.047	.402
27464.4	190.63	.67	-.26	21579	24347	24205	58	876	215	1.049	.403
27203.2	190.89	.68	-.26	21414	24202	24097	57	876	215	1.052	.404

X(E)COORDINATES

TABLE 3.5-25 (CONTINUED)

LM-10 PRE P.D.I. TO TOUCHDOWN

WEIGHT LBS.	X-BAR	Y-BAR INCHES	Z-BAR	IXX	IYY	IZZ SLUG-FT SQ	PXY	PXZ	PYZ	PILOT ROLL DEGREES	PILOT PITCH DEGREES
26942.0	191.17	.68	-.26	21250	24055	23987	56	877	215	1.054	.404
26680.8	191.46	.69	-.26	21086	23902	23872	55	877	215	1.056	.405
26419.6	191.76	.70	-.27	20922	23749	23756	54	878	215	1.058	.406
26159.4	192.07	.70	-.27	20757	23589	23633	52	878	215	1.060	.407
25897.2	192.39	.71	-.27	20593	23428	23509	51	879	215	1.062	.407
25636.0	192.73	.72	-.28	20429	23264	23382	50	879	215	1.063	.408
25374.8	193.07	.73	-.28	20265	23096	23252	48	880	215	1.065	.408
25113.6	193.43	.73	-.28	20100	22925	23117	47	880	216	1.066	.409
24852.4	193.81	.74	-.28	19936	22749	22979	45	881	216	1.067	.409
24591.2	194.19	.75	-.29	19772	22570	22837	44	882	216	1.068	.410
24330.0	194.60	.76	-.29	19608	22386	22691	42	882	216	1.069	.410
24068.8	195.01	.77	-.29	19443	22198	22540	41	883	216	1.069	.410
23807.6	195.44	.77	-.30	19279	22006	22385	39	883	216	1.070	.410
23546.4	195.89	.78	-.30	19115	21810	22226	37	884	216	1.070	.411
23285.2	196.35	.79	-.30	18951	21609	22063	35	885	216	1.071	.411
23024.0	196.82	.80	-.31	18786	21404	21895	33	886	216	1.071	.411
22762.8	197.32	.81	-.31	18622	21194	21722	31	886	216	1.071	.411
22501.6	197.82	.82	-.31	18458	20979	21545	29	887	216	1.071	.411
22240.4	198.35	.83	-.32	18294	20760	21363	27	888	216	1.070	.411
21979.2	198.89	.84	-.32	18129	20536	21176	25	889	216	1.070	.410
21718.0	199.45	.85	-.33	17965	20308	20985	23	890	216	1.070	.410
21456.8	200.02	.86	-.33	17801	20075	20790	21	890	217	1.069	.410
21195.6	200.62	.87	-.33	17637	19837	20589	18	891	217	1.068	.410
20934.4	201.21	.88	-.34	17472	19603	20392	16	892	217	1.068	.410
20673.2	201.83	.89	-.34	17308	19360	20187	13	893	217	1.068	.410
20412.0	202.48	.90	-.35	17144	19109	19972	11	894	217	1.067	.409
20150.8	203.14	.91	-.35	16980	18853	19754	8	895	217	1.066	.409
19889.6	203.82	.93	-.36	16815	18594	19532	6	896	217	1.065	.409
19628.4	204.52	.94	-.36	16651	18330	19306	3	897	217	1.064	.408
19367.2	205.24	.95	-.36	16487	18063	19075	0	898	217	1.064	.408
19106.0	205.98	.96	-.37	16322	17790	18840	-2	900	217	1.063	.408
18844.8	206.74	.98	-.38	16158	17513	18601	-5	901	217	1.062	.407
18583.6	207.52	.99	-.38	15994	17232	18356	-8	902	217	1.061	.407
18322.4	208.32	1.01	-.39	15830	16945	18107	-11	903	217	1.061	.407
18061.2	209.15	1.02	-.39	15665	16653	17852	-15	904	218	1.060	.407
17800.0	210.00	1.04	-.40	15501	16356	17592	-18	906	218	1.059	.406
17538.8	210.88	1.05	-.40	15337	16053	17326	-21	907	218	1.058	.406

Amendment 94
12/10/70

X(E)COORDINATES TABLE 3.5-26 LM-10 AS LUNAR LIFTOFF TO INSERTION

WEIGHT LBS.	X-BAR	Y-BAR INCHES	Z-BAR	IXX	IYY	IZZ SLUG-FT SQ.	PXY	PRZ	PVZ	ROLL MOMENT OFFSET (DEG./SEC. SQ.)	PITCH MOMENT
10873.1	244.45	-.11	2.83	6767	3429	5976	46	245	-18	-.312	5.906
10613.1	244.86	-.11	2.90	6589	3413	5783	46	243	-18	-.327	5.650
10353.1	245.28	-.12	2.97	6410	3396	5588	46	240	-18	-.344	5.378
10093.1	245.72	-.12	3.04	6232	3378	5393	46	237	-18	-.363	5.089
9833.1	246.19	-.12	3.12	6053	3360	5197	46	234	-18	-.383	4.781
9573.1	246.69	-.12	3.21	5874	3340	4999	46	231	-18	-.406	4.453
9313.1	247.21	-.13	3.30	5696	3319	4801	47	227	-18	-.431	4.103
9053.1	247.76	-.13	3.39	5517	3297	4602	47	223	-18	-.458	3.727
8793.1	248.34	-.13	3.49	5338	3274	4401	47	220	-18	-.489	3.324
8533.1	248.96	-.13	3.60	5159	3249	4199	47	216	-18	-.524	2.890
8273.1	249.62	-.14	3.71	4980	3223	3995	47	211	-18	-.563	2.422
8013.1	250.32	-.14	3.83	4802	3195	3790	47	206	-18	-.607	1.915
7753.1	251.07	-.14	3.96	4623	3166	3583	47	202	-18	-.658	1.364
7493.1	251.87	-.15	4.10	4444	3134	3374	47	196	-18	-.716	.763
7233.1	252.73	-.15	4.25	4264	3100	3163	47	191	-18	-.784	.105
6973.1	253.65	-.15	4.41	4085	3063	2949	48	184	-18	-.864	-.619
6713.1	254.65	-.16	4.58	3906	3023	2733	48	178	-18	-.960	-1.418
6453.1	255.72	-.16	4.76	3727	2981	2513	48	171	-18	-1.076	-2.305
6193.1	256.89	-.17	4.96	3547	2934	2290	48	163	-18	-1.218	-3.296
5933.1	258.15	-.17	5.18	3368	2884	2063	48	155	-18	-1.398	-4.409

И И Е Е Е Е Е Е Е Е Е Е Е Е И И Е Е Е Е Е

M M M M E E E E E E E E E E E E E E E E E E

4.0 CSN REFERENCE
CONSUMABLES

XXXXXXXXXXXX

XXXXXXXXXXXX

XXXXXXXXXXXX

XXXXXXXXXXXX



E E E E E E E E E E

E E E E

4.1 SPS CONSUMABLES
MASS PROPERTIES

E E E E E E E E

E E E E E E E E E E

E E E E E E E E E E E E E E E E E E

4.0 CSM REFERENCE CONSUMABLE MASS PROPERTIES DATA

The data presented in this section will enable the user to obtain the separate centers-of-gravity and moments-of-inertia for those spacecraft consumables on-board that significantly affect overall CSM and CM performance. CSM consumables mass property data must be compared to the current on-board consumable loading data for each mission provided in Section 3.0. The mass property data are presented in the following sections:

- 4.1 SPS Tank Consumables Mass Properties, Trapped Propellants, SPS Density Equations and Graphs, and SPS Loading Windows.
- 4.2 RCS/ECS/EPS Consumables Mass Properties, and SM RCS Quad Mass Properties
- 4.3 CSM RCS Load Calculation Tables and Loading Windows
- 4.4 CM Ablator Data

U U

M M M M E

TABLE 4.1-1

Table 4.1-1 presents the mass characteristics for the SM/SPS propellant tanks.

The following units apply to the indicated headings:

Height of Propellant - Inches	Mass of Propellant - Pounds
Tank Volume Unstretched - Ft ³	Center of Mass - X _A Coordinates - Inches
Tank Volume Stretched - Ft ³	Moment of Inertia (I _{YY}) - Slug-ft ²

Further, Moment of Inertia I_{ZZ} = Moment of Inertia I_{YY}; Moment of Inertia I_{XX} = 0.0 for all propellant weights; tank pressure used in calculating this table was 175±5 PSIA, propellant temperature was 70°F, density for fuel was 56.43 lb/ft³, and oxidizer density was 90.21 lb/ft³.

The Y_A and Z_A Center of Mass components for the individual tanks are constant and are as follows:

	Y _A (inches)	Z _A (inches)
Fuel Storage	-14.8	-47.8
Fuel Sump	-48.3	-6.6
Oxidizer Storage	14.8	47.8
Oxidizer Sump	48.3	6.6



TABLE 4.1-1 (Continued)

FUEL STORAGE TANK

HEIGHT OF PROPELLANT	TANK VOLUME UNSTRECHED	TANK VOLUME STRECHED	MASS OF PROPELLANT	CENTER OF MASS	MOMENT OF INERTIA(LYY)
2.00	0.09	0.09	5.0	834.21	0.0
3.00	0.28	0.28	16.0	834.2	0.0
4.00	0.54	0.55	30.9	834.8	0.0
5.00	0.87	0.88	49.8	835.4	0.0
6.00	1.27	1.28	72.2	836.1	1.0
7.00	1.72	1.74	98.1	836.7	1.5
8.00	2.23	2.25	127.1	837.3	1.8
9.00	2.79	2.82	159.2	838.0	2.5
10.00	3.41	3.43	194.1	838.6	3.0
11.00	4.06	4.10	231.6	839.2	3.5
12.00	4.76	4.80	271.4	839.8	4.0
13.00	5.50	5.55	313.4	840.5	4.5
14.00	6.27	6.32	357.4	841.1	5.0
15.00	7.07	7.13	403.2	841.7	6.0
16.00	7.90	7.97	450.5	842.3	7.0
17.00	8.76	8.83	499.2	842.9	8.0
18.00	9.63	9.71	549.0	843.5	9.0
19.00	10.52	10.61	599.7	844.1	10.0
20.00	11.42	11.52	651.2	844.7	11.0
21.00	12.34	12.44	703.2	845.2	12.0
22.00	13.25	13.37	755.4	845.8	12.8
22.50	13.71	13.83	781.6	846.1	13.9
23.00	14.17	14.29	807.8	846.4	14.8
24.00	15.09	15.22	860.2	846.9	15.7
25.00	16.01	16.15	912.6	847.5	16.8
26.00	16.93	17.08	965.1	848.0	17.3
27.00	17.85	18.00	1017.5	848.5	18.2
28.00	18.77	18.93	1069.9	849.1	19.0
29.00	19.69	19.86	1122.3	849.6	20.0
30.00	20.61	20.78	1174.7	850.1	21.1
31.00	21.53	21.71	1227.1	850.7	22.6
32.00	22.45	22.64	1279.5	851.2	23.9
33.00	23.37	23.57	1331.9	851.7	25.0
34.00	24.28	24.49	1384.3	852.2	26.5
35.00	25.20	25.42	1436.7	852.7	27.7
36.00	26.12	26.35	1489.1	853.3	29.0
37.00	27.04	27.27	1541.5	853.8	30.6

TABLE 4.1-1 (Continued)
FUEL STORAGE TANK

HEIGHT OF PROPELLANT	TANK VOLUME UNSTRECHED	TANK VOLUME STRECHED	MASS OF PROPELLANT	CENTER OF MASS	MOMENT OF INERTIA(IYY)
38.00	27.96	28.20	1593.9	854.3	32.0
39.00	28.88	29.13	1646.3	854.8	33.8
40.00	29.80	30.06	1698.7	855.3	35.7
41.00	30.72	30.98	1751.1	855.8	37.0
42.00	31.64	31.91	1803.5	856.3	38.7
43.00	32.56	32.84	1855.9	856.9	40.5
44.00	33.48	33.76	1908.3	857.4	42.6
45.00	34.40	34.69	1960.7	857.9	44.9
46.00	35.32	35.62	2013.1	858.4	47.5
47.00	36.24	36.55	2065.5	858.9	50.3
48.00	37.15	37.47	2117.9	859.4	53.3
49.00	38.07	38.40	2170.3	859.9	56.6
50.00	38.99	39.33	2222.7	860.4	60.2
51.00	39.91	40.25	2275.1	860.9	64.0
52.00	40.83	41.18	2327.5	861.4	68.1
53.00	41.75	42.11	2379.9	861.9	72.4
54.00	42.67	43.04	2432.3	862.5	77.0
55.00	43.59	43.96	2484.7	863.0	81.8
56.00	44.51	44.89	2537.1	863.5	87.0
57.00	45.43	45.82	2589.5	864.0	92.4
58.00	46.35	46.74	2641.9	864.5	98.1
59.00	47.27	47.67	2694.3	865.0	104.1
60.00	48.19	48.60	2746.7	865.5	110.4
61.00	49.11	49.53	2799.1	866.0	117.0
62.00	50.02	50.45	2851.5	866.5	124.0
63.00	50.94	51.38	2903.9	867.0	131.2
64.00	51.86	52.31	2956.3	867.5	138.7
65.00	52.78	53.23	3008.7	868.0	146.6
66.00	53.70	54.16	3061.1	868.5	154.8
67.00	54.62	55.09	3113.5	869.0	163.3
68.00	55.54	56.02	3165.9	869.5	172.2
69.00	56.46	56.94	3218.3	870.0	181.4
70.00	57.38	57.87	3270.7	870.5	191.0
71.00	58.30	58.80	3323.1	871.0	201.0
72.00	59.22	59.72	3375.5	871.5	211.3
73.00	60.14	60.65	3427.9	872.0	221.9
74.00	61.06	61.58	3480.3	872.5	233.0

TABLE 4.1-1 (Continued)

FUEL STORAGE TANK

HEIGHT OF PROPELLANT	TANK VOLUME UNSTRECHED	TANK VOLUME STRECHED	MASS OF PROPELLANT	CENTER OF MASS	MOMENT OF INERTIA(IYY)
75.00	61.98	62.51	3532.7	873.0	244.4
76.00	62.89	63.43	3585.1	873.5	256.2
77.00	63.81	64.36	3637.5	874.0	268.4
78.00	64.73	65.29	3689.9	874.6	281.1
79.00	65.65	66.21	3742.3	875.1	294.1
80.00	66.57	67.14	3794.8	875.6	307.5
81.00	67.49	68.07	3847.2	876.1	321.3
82.00	68.41	69.00	3899.6	876.6	335.6
83.00	69.33	69.92	3952.0	877.1	350.3
84.00	70.25	70.85	4004.4	877.6	365.4
85.00	71.17	71.78	4056.8	878.1	381.0
86.00	72.09	72.70	4109.2	878.6	397.0
87.00	73.01	73.63	4161.6	879.1	413.4
88.00	73.93	74.56	4214.0	879.6	430.3
89.00	74.85	75.49	4266.4	880.1	447.7
90.00	75.76	76.41	4318.8	880.6	465.5
91.00	76.68	77.34	4371.2	881.1	483.8
92.00	77.60	78.27	4423.6	881.6	502.6
93.00	78.52	79.19	4476.0	882.1	521.9
94.00	79.44	80.12	4528.4	882.6	541.7
95.00	80.36	81.05	4580.8	883.1	561.9
96.00	81.28	81.97	4633.2	883.6	582.7
97.00	82.20	82.90	4685.6	884.1	603.9
98.00	83.12	83.83	4738.0	884.6	625.7
99.00	84.04	84.76	4790.4	885.1	648.0
100.00	84.96	85.68	4842.8	885.6	670.8
101.00	85.88	86.61	4895.2	886.1	694.2
102.00	86.80	87.54	4947.6	886.6	718.1
103.00	87.71	88.46	5000.0	887.1	742.5
104.00	88.63	89.39	5052.4	887.6	767.5
105.00	89.55	90.32	5104.8	888.1	793.0
106.00	90.47	91.25	5157.2	888.6	819.1
107.00	91.39	92.17	5209.6	889.1	845.8
108.00	92.31	93.10	5262.0	889.6	873.0
109.00	93.23	94.03	5314.4	890.1	900.8
110.00	94.15	94.95	5366.8	890.6	929.2
111.00	95.07	95.88	5419.2	891.1	958.2

TABLE 4.1-1 (Continued)

FUEL STORAGE TANK

HEIGHT OF PROPELLANT	TANK VOLUME UNSTRETCHED	TANK VOLUME STRETCHED	MASS OF PROPELLANT	CENTER OF MASS	MOMENT OF INERTIA (IYY)
112.00	95.99	96.81	5471.6	891.6	987.7
113.00	96.91	97.74	5524.0	892.1	1017.9
114.00	97.83	98.66	5576.4	892.6	1048.7
115.00	98.75	99.59	5628.8	893.1	1080.1
116.00	99.67	100.52	5681.2	893.6	1112.1
117.00	100.58	101.44	5733.6	894.1	1144.7
118.00	101.50	102.37	5786.0	894.6	1177.9
119.00	102.42	103.30	5838.4	895.1	1211.8
120.00	103.34	104.23	5890.8	895.6	1246.3
121.00	104.26	105.15	5943.2	896.1	1281.5
122.00	105.18	106.08	5995.6	896.6	1317.3
123.00	106.10	107.01	6048.0	897.1	1353.8
124.00	107.02	107.93	6100.4	897.6	1390.9
125.00	107.94	108.86	6152.8	898.1	1428.7
126.00	108.86	109.79	6205.2	898.6	1467.2
127.00	109.78	110.72	6257.6	899.1	1506.4
128.00	110.70	111.64	6310.0	899.6	1546.2
129.00	111.62	112.57	6362.4	900.1	1586.8
130.00	112.54	113.50	6414.8	900.6	1628.0
131.00	113.45	114.42	6467.2	901.1	1669.9
132.00	114.37	115.35	6519.6	901.6	1712.6
132.20	114.56	115.54	6530.1	901.7	1721.2
133.00	115.29	116.28	6572.0	902.1	1755.9
134.00	116.21	117.20	6624.3	902.6	1799.8
135.00	117.12	118.12	6676.1	903.1	1844.1
136.00	118.02	119.03	6727.4	903.6	1888.7
137.00	118.90	119.92	6777.8	904.1	1933.2
138.00	119.77	120.80	6827.3	904.6	1977.5
139.00	120.62	121.65	6875.6	905.0	2021.4
140.00	121.44	122.48	6922.5	905.5	2064.6
141.00	122.23	123.28	6967.7	905.9	2106.9
142.00	123.00	124.05	7011.2	906.3	2148.0
143.00	123.72	124.78	7052.6	906.7	2187.7
144.00	124.41	125.47	7091.7	907.1	2225.7
145.00	125.05	126.12	7128.4	907.5	2261.8
146.00	125.65	126.73	7162.5	907.8	2295.5
147.00	126.20	127.28	7193.7	908.1	2326.7

TABLE 4.1-1 (CONTINUED)

FUEL STORAGE TANK

HEIGHT OF PROPELLANT	TANK VOLUME UNSTRECHED	TANK VOLUME STRECHED	MASS OF PROPELLANT	CENTER OF MASS	MOMENT OF INERTIA(IYY)
148.00	126.69	127.78	7221.8	908.4	2355.1
149.00	127.13	128.22	7246.7	908.6	2380.4
150.00	127.50	128.59	7268.1	908.9	2402.3
151.00	127.81	128.91	7285.7	909.0	2420.5
152.00	128.06	129.15	7299.5	909.2	2434.7
153.00	128.23	129.32	7309.2	909.3	2444.7
154.00	128.32	129.42	7314.6	909.3	2450.3
154.70	128.34	129.44	7315.7	909.3	2451.5

TABLE 4.1-1 (Continued)
FUEL SUMP TANK

HEIGHT OF PROPELLANT	TANK VOLUME UNSTRECHED	TANK VOLUME STRECHED	MASS OF PROPELLANT	CENTER OF MASS	MOMENT OF INERTIA(IYY)
4.00	5.02	5.02	283.7	860.5	12.0
5.00	5.31	5.31	300.3	859.1	12.0
6.00	5.67	5.68	321.2	857.7	12.0
7.00	6.11	6.12	346.1	856.3	12.0
8.00	6.61	6.63	374.9	855.0	12.0
9.00	7.18	7.21	407.3	853.9	12.0
10.00	7.81	7.84	443.1	852.9	12.0
11.00	8.49	8.53	482.1	852.0	12.0
12.00	9.23	9.27	524.1	851.3	12.1
13.00	10.01	10.07	568.9	850.8	12.2
14.00	10.85	10.91	616.3	850.4	12.3
15.00	11.72	11.79	666.1	850.1	12.4
16.00	12.63	12.71	718.1	849.9	12.5
17.00	13.57	13.66	772.0	849.8	12.7
18.00	14.55	14.65	827.7	849.8	12.8
19.00	15.56	15.66	885.0	849.8	13.0
20.00	16.58	16.70	943.6	849.9	13.3
21.00	17.63	17.75	1003.3	850.1	13.5
22.00	18.69	18.83	1064.0	850.2	13.8
23.00	19.77	19.91	1125.4	850.5	14.0
24.00	20.86	21.01	1187.3	850.7	14.3
25.00	21.95	22.11	1249.5	851.0	14.6
25.50	22.49	22.66	1280.7	851.2	14.9
26.00	23.04	23.21	1311.8	851.3	15.2
27.00	24.13	24.31	1374.0	851.6	15.4
28.00	25.22	25.41	1436.2	852.0	15.7
29.00	26.31	26.51	1498.4	852.3	16.0
30.00	27.41	27.61	1560.7	852.7	16.7
31.00	28.50	28.71	1622.9	853.1	17.1
32.00	29.59	29.82	1685.1	853.5	17.6
33.00	30.68	30.92	1747.3	853.8	18.2
34.00	31.77	32.02	1809.5	854.2	18.7
35.00	32.86	33.12	1871.8	854.7	19.2
36.00	33.96	34.22	1934.0	855.1	20.0
37.00	35.05	35.32	1996.2	855.5	20.6
38.00	36.14	36.42	2058.4	855.9	21.2
39.00	37.23	37.52	2120.6	856.3	22.1

Table 4.1-1 (Continued)

FUEL SUMP TANK

HEIGHT OF PROPELLANT	TANK VOLUME UNSTRETCHED	TANK VOLUME STRETCHED	MASS OF PROPELLANT	CENTER OF MASS	MOMENT OF INERTIA(IYY)
40.00	38.32	38.62	2182.9	856.8	23.0
41.00	39.41	39.72	2245.1	857.2	24.3
42.00	40.51	40.82	2307.3	857.6	25.8
43.00	41.60	41.92	2369.5	858.1	27.7
44.00	42.69	43.03	2431.7	858.5	29.9
45.00	43.78	44.13	2494.0	859.0	32.3
46.00	44.87	45.23	2556.2	859.4	35.1
47.00	45.96	46.33	2618.4	859.9	38.1
48.00	47.06	47.43	2680.6	860.3	41.5
49.00	48.15	48.53	2742.8	860.8	45.1
50.00	49.24	49.63	2805.1	861.2	49.0
51.00	50.33	50.73	2867.3	861.7	53.2
52.00	51.42	51.83	2929.5	862.2	57.7
53.00	52.51	52.93	2991.7	862.6	62.5
54.00	53.61	54.03	3053.9	863.1	67.6
55.00	54.70	55.13	3116.2	863.6	73.1
56.00	55.79	56.24	3178.4	864.0	78.8
57.00	56.88	57.34	3240.6	864.5	84.9
58.00	57.97	58.44	3302.8	865.0	91.4
58.02	57.99	58.46	3304.1	865.0	91.5
59.00	59.15	59.62	3369.8	865.5	100.8
60.00	60.33	60.81	3436.9	866.0	108.2
61.00	61.50	62.00	3504.1	866.5	115.9
62.00	62.68	63.18	3571.2	867.0	123.9
63.00	63.86	64.37	3638.3	867.5	132.4
64.00	65.04	65.56	3705.4	868.0	141.2
65.00	66.21	66.75	3772.5	868.5	150.5
66.00	67.39	67.93	3839.6	869.0	160.1
67.00	68.57	69.12	3906.7	869.5	170.2
68.00	69.75	70.31	3973.8	870.0	180.7
69.00	70.92	71.50	4040.9	870.5	191.6
70.00	72.10	72.68	4108.0	871.0	203.0
71.00	73.28	73.87	4175.1	871.5	214.8
72.00	74.46	75.06	4242.3	872.0	227.1
73.00	75.63	76.25	4309.4	872.6	239.8
74.00	76.81	77.43	4376.5	873.1	253.0
75.00	77.99	78.62	4443.6	873.6	266.7

TABLE 4.1-1 (Continued)
FUEL SUMP TANK

HEIGHT OF PROPELLANT	TANK VOLUME UNSTRECHED	TANK VOLUME STRECHED	MASS OF PROPELLANT	CENTER OF MASS	MOMENT OF INERTIA(IYY)
113.00	122.73	123.74	6993.7	892.7	1218.0
114.00	123.91	124.93	7060.8	893.2	1256.4
115.00	125.09	126.11	7127.9	893.7	1295.5
116.00	126.26	127.30	7195.0	894.2	1335.4
117.00	127.44	128.49	7262.1	894.7	1376.2
118.00	128.62	129.68	7329.2	895.2	1417.7
119.00	129.79	130.86	7396.4	895.7	1460.0
120.00	130.97	132.05	7463.5	896.2	1503.2
121.00	132.15	133.24	7530.6	896.7	1547.2
122.00	133.33	134.43	7597.7	897.2	1592.0
123.00	134.50	135.61	7664.8	897.7	1637.7
124.00	135.68	136.80	7731.9	898.2	1684.2
125.00	136.86	137.99	7799.0	898.7	1731.6
126.00	138.04	139.17	7866.1	899.2	1779.8
127.00	139.21	140.36	7933.2	899.7	1829.0
128.00	140.39	141.55	8000.3	900.2	1879.0
128.30	140.75	141.91	8020.5	900.3	1894.1
129.00	141.57	142.74	8067.4	900.7	1929.8
130.00	142.74	143.92	8134.4	901.2	1981.5
131.00	143.91	145.10	8201.0	901.7	2033.8
132.00	145.07	146.27	8267.0	902.2	2086.5
132.90	146.10	147.31	8325.8	902.6	2134.1
133.00	146.22	147.42	8332.3	902.7	2139.5
134.00	147.35	148.56	8396.8	903.2	2192.7
135.00	148.46	149.69	8460.2	903.6	2245.8
136.00	149.55	150.78	8522.2	904.1	2298.5
137.00	150.61	151.85	8582.5	904.6	2350.7
138.00	151.63	152.89	8641.1	905.0	2402.0
139.00	152.63	153.89	8697.6	905.4	2452.3
140.00	153.58	154.85	8752.0	905.8	2501.2
141.00	154.49	155.77	8803.9	906.2	2548.6
142.00	155.36	156.64	8853.2	906.6	2594.0
143.00	156.17	157.46	8899.6	907.0	2637.4
144.00	156.93	158.23	8943.0	907.3	2678.3
145.00	157.64	158.94	8983.1	907.6	2716.6
146.00	158.28	159.59	9019.8	907.9	2751.8
147.00	158.86	160.17	9052.8	908.1	2783.8

K
L
M
N
O
P
Q
R
S
T
U
V
W
X
Y
Z

Table 4.1-1 (Continued)
FUEL SUMP TANK

HEIGHT OF PROPELLANT	TANK VOLUME UNSTRECHED	TANK VOLUME STRECHED	MASS OF PROPELLANT	CENTER OF MASS	MOMENT OF INERTIA(IYY)
148.00	159.37	160.69	9082.0	908.4	2812.2
149.00	159.81	161.13	9107.0	908.6	2836.8
150.00	160.17	161.50	9127.8	908.7	2857.3
151.00	160.46	161.78	9144.0	908.9	2873.4
152.00	160.66	161.99	9155.6	909.0	2884.9
153.00	160.78	162.11	9162.2	909.0	2891.5
153.80	160.81	162.14	9163.9	909.0	2893.1

TABLE 4.1-1 (Continued)
OXIDIZER STORAGE TANK

HEIGHT OF PROPELLANT	TANK VOLUME UNSTRETCHED	TANK VOLUME STRETCHED	MASS OF PROPELLANT	CENTER OF MASS	MOMENT OF INERTIA(IYY)
2.00	0.09	0.09	8.0	834.2	0.1
3.00	0.28	0.28	25.5	834.2	0.4
4.00	0.54	0.55	49.4	834.8	0.9
5.00	0.87	0.88	79.4	835.4	1.6
6.00	1.27	1.28	115.2	836.1	2.3
7.00	1.72	1.74	156.4	836.7	3.1
8.00	2.23	2.25	202.8	837.3	4.1
9.00	2.79	2.82	254.0	838.0	5.2
10.00	3.41	3.43	309.6	838.6	6.3
11.00	4.06	4.10	369.4	839.2	7.6
12.00	4.76	4.80	432.9	839.8	8.9
13.00	5.50	5.55	500.0	840.5	10.3
14.00	6.27	6.32	570.2	841.1	11.6
15.00	7.07	7.13	643.1	841.7	13.2
16.00	7.90	7.97	718.6	842.3	14.7
17.00	8.76	8.83	796.2	842.9	16.4
18.00	9.63	9.71	875.7	843.5	18.0
19.00	10.52	10.61	956.6	844.1	19.8
20.00	11.42	11.52	1038.7	844.7	21.4
21.00	12.34	12.44	1121.6	845.2	23.2
22.00	13.25	13.37	1205.0	845.8	24.9
22.50	13.71	13.83	1246.8	846.1	25.8
23.00	14.17	14.29	1288.5	846.4	26.7
24.00	15.09	15.22	1372.1	846.9	28.5
25.00	16.01	16.15	1455.7	847.5	30.3
26.00	16.93	17.08	1539.3	848.0	32.8
27.00	17.85	18.00	1622.9	848.5	33.7
28.00	18.77	18.93	1706.5	849.1	35.5
29.00	19.69	19.86	1790.0	849.6	37.3
30.00	20.61	20.78	1873.6	850.1	39.0
31.00	21.53	21.71	1957.2	850.7	40.7
32.00	22.45	22.64	2040.8	851.2	42.6
33.00	23.37	23.57	2124.4	851.7	44.3
34.00	24.28	24.49	2207.9	852.2	46.0
35.00	25.20	25.42	2291.5	852.7	47.8
36.00	26.12	26.35	2375.1	853.3	49.5
37.00	27.04	27.27	2458.7	853.8	51.3

TABLE 4.1-1 (Continued)

OXIDIZER STORAGE TANK

HEIGHT OF PROPELLANT	TANK VOLUME UNSTRECHED	TANK VOLUME STRECHED	MASS OF PROPELLANT	CENTER OF MASS	MOMENT OF INERTIA(IYY)
38.00	27.96	28.20	2542.3	854.3	53.2
39.00	28.88	29.13	2625.9	854.8	55.2
40.00	29.80	30.06	2709.4	855.3	56.9
41.00	30.72	30.98	2793.0	855.8	59.1
42.00	31.64	31.91	2876.6	856.3	61.7
43.00	32.56	32.84	2960.2	856.9	64.6
44.00	33.48	33.76	3043.8	857.4	68.0
45.00	34.40	34.69	3127.3	857.9	71.7
46.00	35.32	35.62	3210.9	858.4	75.8
47.00	36.24	36.55	3294.5	858.9	80.2
48.00	37.15	37.47	3378.1	859.4	85.1
49.00	38.07	38.40	3461.7	859.9	90.4
50.00	38.99	39.33	3545.2	860.4	96.0
51.00	39.91	40.25	3628.8	860.9	102.1
52.00	40.83	41.18	3712.4	861.4	108.6
53.00	41.75	42.11	3796.0	861.9	115.5
54.00	42.67	43.04	3879.6	862.5	122.8
55.00	43.59	43.96	3963.2	863.0	130.6
56.00	44.51	44.89	4046.7	863.5	138.8
57.00	45.43	45.82	4130.3	864.0	147.4
58.00	46.35	46.74	4213.9	864.5	156.5
59.00	47.27	47.67	4297.5	865.0	166.1
60.00	48.19	48.60	4381.1	865.5	176.2
61.00	49.11	49.53	4464.6	866.0	186.7
62.00	50.02	50.45	4548.2	866.5	197.7
63.00	50.94	51.38	4631.8	867.0	209.3
64.00	51.86	52.31	4715.4	867.5	221.3
65.00	52.78	53.23	4799.0	868.0	233.9
66.00	53.70	54.16	4882.6	868.5	246.9
67.00	54.62	55.09	4966.1	869.0	260.6
68.00	55.54	56.02	5049.7	869.5	274.7
69.00	56.46	56.94	5133.3	870.0	289.4
70.00	57.38	57.87	5216.9	870.5	304.7
71.00	58.30	58.80	5300.5	871.0	320.6
72.00	59.22	59.72	5384.0	871.5	337.0
73.00	60.14	60.65	5467.6	872.0	354.0
74.00	61.06	61.58	5551.2	872.5	371.6

TABLE 4.1-1 (Continued)

OXIDIZER STORAGE TANK

HEIGHT OF PROPELLANT	TANK VOLUME UNSTRETCHED	TANK VOLUME STRETCHED	MASS OF PROPELLANT	CENTER OF MASS	MOMENT OF INERTIA(IYY)
75.00	61.98	62.51	5634.8	873.0	389.9
76.00	62.89	63.43	5718.4	873.5	408.7
77.00	63.81	64.36	5802.0	874.0	428.2
78.00	64.73	65.29	5885.5	874.6	448.3
79.00	65.65	66.21	5969.1	875.1	469.1
80.00	66.57	67.14	6052.7	875.6	490.5
81.00	67.49	68.07	6136.3	876.1	512.5
82.00	68.41	69.00	6219.9	876.6	535.3
83.00	69.33	69.92	6303.4	877.1	558.7
84.00	70.25	70.85	6387.0	877.6	582.8
85.00	71.17	71.78	6470.6	878.1	607.6
86.00	72.09	72.70	6554.2	878.6	633.2
87.00	73.01	73.63	6637.8	879.1	659.4
88.00	73.93	74.56	6721.3	879.6	686.4
89.00	74.85	75.49	6804.9	880.1	714.1
90.00	75.76	76.41	6888.5	880.6	742.5
91.00	76.68	77.34	6972.1	881.1	771.7
92.00	77.60	78.27	7055.7	881.6	801.7
93.00	78.52	79.19	7139.3	882.1	832.4
94.00	79.44	80.12	7222.8	882.6	864.0
95.00	80.36	81.05	7306.4	883.1	896.3
96.00	81.28	81.97	7390.0	883.6	929.4
97.00	82.20	82.90	7473.6	884.1	963.3
98.00	83.12	83.83	7557.2	884.6	998.1
99.00	84.04	84.76	7640.7	885.1	1033.6
100.00	84.96	85.68	7724.3	885.6	1070.0
101.00	85.88	86.61	7807.9	886.1	1107.3
102.00	86.80	87.54	7891.5	886.6	1145.4
103.00	87.71	88.46	7975.1	887.1	1184.4
104.00	88.63	89.39	8058.7	887.6	1224.2
105.00	89.55	90.32	8142.2	888.1	1264.9
106.00	90.47	91.25	8225.8	888.6	1306.6
107.00	91.39	92.17	8309.4	889.1	1349.1
108.00	92.31	93.10	8393.0	889.6	1392.5
109.00	93.23	94.03	8476.6	890.1	1436.8
110.00	94.15	94.95	8560.1	890.6	1482.1
111.00	95.07	95.88	8643.7	891.1	1528.3

TABLE 4.1-1 (Continued)
OXIDIZER STORAGE TANK

HEIGHT OF PROPELLANT	TANK VOLUME UNSTRECHED	TANK VOLUME STRECHED	MASS OF PROPELLANT	CENTER OF MASS	MOMENT OF INERTIA(IYY)
112.00	95.99	96.81	8727.3	891.6	1575.5
113.00	96.91	97.74	8810.9	892.1	1623.6
114.00	97.83	98.66	8894.5	892.6	1672.7
115.00	98.75	99.59	8978.0	893.1	1722.7
116.00	99.67	100.52	9061.6	893.6	1773.8
117.00	100.58	101.44	9145.2	894.1	1825.8
118.00	101.50	102.37	9228.8	894.6	1878.8
119.00	102.42	103.30	9312.4	895.1	1932.9
120.00	103.34	104.23	9396.0	895.6	1988.0
121.00	104.26	105.15	9479.5	896.1	2044.0
122.00	105.18	106.08	9563.1	896.6	2101.2
123.00	106.10	107.01	9646.7	897.1	2159.4
124.00	107.02	107.93	9730.3	897.6	2218.6
125.00	107.94	108.86	9813.9	898.1	2278.9
126.00	108.86	109.79	9897.4	898.6	2340.3
127.00	109.78	110.72	9981.0	899.1	2402.7
128.00	110.70	111.64	10064.6	899.6	2466.3
129.00	111.62	112.57	10148.2	900.1	2530.9
130.00	112.54	113.50	10231.8	900.6	2596.7
131.00	113.45	114.42	10315.4	901.1	2663.6
132.00	114.37	115.35	10398.9	901.6	2731.6
132.20	114.56	115.54	10415.7	901.7	2745.3
133.00	115.29	116.28	10482.5	902.1	2800.7
134.00	116.21	117.20	10565.8	902.6	2870.8
135.00	117.12	118.12	10648.5	903.1	2941.4
136.00	118.02	119.03	10730.2	903.6	3012.5
137.00	118.90	119.92	10810.7	904.1	3083.5
138.00	119.77	120.80	10889.7	904.6	3154.2
139.00	120.62	121.65	10966.7	905.0	3224.2
140.00	121.44	122.48	11041.4	905.5	3293.1
141.00	122.23	123.28	11113.6	905.9	3360.6
142.00	123.00	124.05	11182.9	906.3	3426.2
143.00	123.72	124.78	11248.9	906.7	3489.5
144.00	124.41	125.47	11311.4	907.1	3550.1
145.00	125.05	126.12	11369.9	907.5	3607.6
146.00	125.65	126.73	11424.3	907.8	3661.4
147.00	126.20	127.28	11474.0	908.1	3711.2

TABLE 4.1-1(Continued)
OXIDIZER STORAGE TANK

HEIGHT OF PROPELLANT	TANK VOLUME UNSTRECHED	TANK VOLUME STRECHED	MASS OF PROPELLANT	CENTER OF MASS	MOMENT OF INERTIA(IYY)
148.00	126.69	127.78	11518.9	908.4	3756.5
149.00	127.13	128.22	11558.6	908.6	3796.8
150.00	127.50	128.59	11592.7	908.9	3831.7
151.00	127.81	128.91	11620.9	909.0	3860.7
152.00	128.06	129.15	11642.9	909.2	3883.4
153.00	128.23	129.32	11658.3	909.3	3899.4
154.00	128.32	129.42	11666.9	909.3	3908.3
154.70	128.34	129.44	11668.6	909.3	3910.1

TABLE 4.1-1 (Continued)
OXIDIZER SUMP TANK

HEIGHT OF PROPELLANT	TANK VOLUME UNSTRECHED	TANK VOLUME STRECHED	MASS OF PROPELLANT	CENTER OF MASS	MOMENT OF INERTIA (IYY)
4.00	5.02	5.02	452.5	860.5	19.3
5.00	5.31	5.31	479.7	859.1	20.1
6.00	5.67	5.68	512.3	857.7	20.5
7.00	6.11	6.12	552.1	856.3	20.8
8.00	6.61	6.63	598.0	855.0	21.0
9.00	7.18	7.21	649.6	853.9	21.4
10.00	7.81	7.84	706.7	852.9	21.8
11.00	8.49	8.53	768.9	852.0	22.1
12.00	9.23	9.27	836.0	851.3	22.4
13.00	10.01	10.07	907.4	850.8	23.0
14.00	10.85	10.91	983.1	850.4	23.5
15.00	11.72	11.79	1062.5	850.1	24.0
16.00	12.63	12.71	1145.4	849.9	24.4
17.00	13.57	13.66	1231.4	849.8	25.1
18.00	14.55	14.65	1320.2	849.8	25.6
19.00	15.56	15.66	1411.6	849.8	25.9
20.00	16.58	16.70	1505.0	849.9	26.1
21.00	17.63	17.75	1600.3	850.1	26.4
22.00	18.69	18.83	1697.1	850.2	26.8
23.00	19.77	19.91	1795.0	850.5	27.1
24.00	20.86	21.01	1893.8	850.7	27.5
25.00	21.95	22.11	1993.7	851.0	27.9
25.50	22.49	22.66	2042.7	851.2	28.2
26.00	23.04	23.21	2092.3	851.3	28.4
27.00	24.13	24.31	2191.6	851.6	28.6
28.00	25.22	25.41	2290.8	852.0	28.8
29.00	26.31	26.51	2390.1	852.3	29.0
30.00	27.41	27.61	2489.3	852.7	29.3
31.00	28.50	28.71	2588.5	853.1	29.8
32.00	29.59	29.82	2687.8	853.5	30.3
33.00	30.68	30.92	2787.0	853.8	31.9
34.00	31.77	32.02	2886.3	854.2	31.6
35.00	32.86	33.12	2985.5	854.7	32.1
36.00	33.96	34.22	3084.8	855.1	32.9
37.00	35.05	35.32	3184.0	855.5	33.9
38.00	36.14	36.42	3283.2	855.9	34.3
39.00	37.23	37.52	3382.5	856.3	35.2

Table 4.1-1 (Continued)

OXIDIZER SUMP TANK

HEIGHT OF PROPELLANT	TANK VOLUME UNSTRECHED	TANK VOLUME STRECHED	MASS OF PROPELLANT	CENTER OF MASS	MOMENT OF INERTIA(IYY)
40.00	38.32	38.62	3481.7	856.8	36.7
41.00	39.41	39.72	3581.0	857.2	38.7
42.00	40.51	40.82	3680.2	857.6	41.2
43.00	41.60	41.92	3779.4	858.1	44.2
44.00	42.69	43.03	3878.7	858.5	47.7
45.00	43.78	44.13	3977.9	859.0	51.6
46.00	44.87	45.23	4077.2	859.4	56.0
47.00	45.96	46.33	4176.4	859.9	60.8
48.00	47.06	47.43	4275.7	860.3	66.1
49.00	48.15	48.53	4374.9	860.8	71.9
50.00	49.24	49.63	4474.1	861.2	78.1
51.00	50.33	50.73	4573.4	861.7	84.9
52.00	51.42	51.83	4672.6	862.2	92.0
53.00	52.51	52.93	4771.9	862.6	99.7
54.00	53.61	54.03	4871.1	863.1	107.9
55.00	54.70	55.13	4970.3	863.6	116.6
56.00	55.79	56.24	5069.6	864.0	125.8
57.00	56.88	57.34	5168.8	864.5	135.5
58.00	57.97	58.44	5268.1	865.0	145.7
58.02	57.99	58.46	5270.1	865.0	146.0
59.00	59.15	59.62	5375.0	865.5	160.9
60.00	60.33	60.81	5482.0	866.0	172.5
61.00	61.50	62.00	5589.0	866.5	184.8
62.00	62.68	63.18	5696.1	867.0	197.7
63.00	63.86	64.37	5803.1	867.5	211.2
64.00	65.04	65.56	5910.1	868.0	225.3
65.00	66.21	66.75	6017.2	868.5	240.0
66.00	67.39	67.93	6124.2	869.0	255.4
67.00	68.57	69.12	6231.3	869.5	271.5
68.00	69.75	70.31	6338.3	870.0	288.2
69.00	70.92	71.50	6445.3	870.5	305.6
70.00	72.10	72.68	6552.4	871.0	323.8
71.00	73.28	73.87	6659.4	871.5	342.6
72.00	74.46	75.06	6766.5	872.0	362.2
73.00	75.63	76.25	6873.5	872.6	382.5
74.00	76.81	77.43	6980.5	873.1	403.5
75.00	77.99	78.62	7087.6	873.6	425.4

Table 4.1-1 (Continued)

OXIDIZER SUMP TANK

HEIGHT OF PROPELLANT	TANK VOLUME UNSTRECHED	TANK VOLUME STRECHED	MASS OF PROPELLANT	CENTER OF MASS	MOMENT OF INERTIA(IYY)
76.00	79.16	79.81	7194.6	874.1	448.0
77.00	80.34	81.00	7301.7	874.6	471.4
78.00	81.52	82.18	7408.7	875.1	495.6
79.00	82.70	83.37	7515.7	875.6	520.6
80.00	83.87	84.56	7622.8	876.1	546.4
81.00	85.05	85.74	7729.8	876.6	573.1
82.00	86.23	86.93	7836.9	877.1	600.6
83.00	87.41	88.12	7943.9	877.6	629.0
84.00	88.58	89.31	8050.9	878.1	658.3
85.00	89.76	90.49	8158.0	878.6	688.4
86.00	90.94	91.68	8265.0	879.1	719.5
87.00	92.12	92.87	8372.0	879.6	751.4
88.00	93.29	94.06	8479.1	880.1	784.3
89.00	94.47	95.24	8586.1	880.6	818.2
90.00	95.65	96.43	8693.2	881.1	853.0
91.00	96.83	97.62	8800.2	881.6	888.7
92.00	98.00	98.81	8907.2	882.1	925.4
93.00	99.18	99.99	9014.3	882.6	963.1
94.00	100.36	101.18	9121.3	883.1	1001.8
95.00	101.54	102.37	9228.4	883.6	1041.5
96.00	102.71	103.55	9335.4	884.1	1082.3
97.00	103.89	104.74	9442.4	884.6	1124.0
98.00	105.07	105.93	9549.5	885.1	1166.8
99.00	106.25	107.12	9656.5	885.6	1210.7
100.00	107.42	108.30	9763.6	886.1	1255.7
101.00	108.60	109.49	9870.6	886.6	1301.7
102.00	109.78	110.68	9977.6	887.1	1348.8
103.00	110.96	111.87	10084.7	887.6	1397.0
104.00	112.13	113.05	10191.7	888.1	1446.4
105.00	113.31	114.24	10298.8	888.7	1496.8
106.00	114.49	115.43	10405.8	889.2	1548.5
107.00	115.67	116.62	10512.8	889.7	1601.2
108.00	116.84	117.80	10619.9	890.2	1655.2
109.00	118.02	118.99	10726.9	890.7	1710.3
110.00	119.20	120.18	10833.9	891.2	1766.6
111.00	120.38	121.36	10941.0	891.7	1824.1
112.00	121.55	122.55	11048.0	892.2	1882.8

Table 4.1-1 (Continued)
OXIDIZER SUMP TANK

HEIGHT OF PROPELLANT	TANK VOLUME UNSTRECHED	TANK VOLUME STRECHED	MASS OF PROPELLANT	CENTER OF MASS	MOMENT OF INERTIA(IYY)
113.00	122.73	123.74	11155.1	892.7	1942.7
114.00	123.91	124.93	11262.1	893.2	2003.9
115.00	125.09	126.11	11369.1	893.7	2066.4
116.00	126.26	127.30	11476.2	894.2	2130.0
117.00	127.44	128.49	11583.2	894.7	2195.0
118.00	128.62	129.68	11690.3	895.2	2261.3
119.00	129.79	130.86	11797.3	895.7	2328.8
120.00	130.97	132.05	11904.3	896.2	2397.7
121.00	132.15	133.24	12011.4	896.7	2467.8
122.00	133.33	134.43	12118.4	897.2	2539.3
123.00	134.50	135.61	12225.5	897.7	2612.2
124.00	135.68	136.80	12332.5	898.2	2686.4
125.00	136.86	137.99	12439.5	898.7	2762.0
126.00	138.04	139.17	12546.6	899.2	2838.9
127.00	139.21	140.36	12653.6	899.7	2917.2
128.00	140.39	141.55	12760.6	900.2	2997.0
128.30	140.75	141.91	12792.8	900.3	3021.2
129.00	141.57	142.74	12867.7	900.7	3078.1
130.00	142.74	143.92	12974.5	901.2	3160.5
131.00	143.91	145.10	13080.7	901.7	3243.9
132.00	145.07	146.27	13186.0	902.2	3328.0
132.90	146.10	147.31	13279.8	902.6	3404.0
133.00	146.22	147.42	13290.2	902.7	3412.5
134.00	147.35	148.56	13393.1	903.2	3497.4
135.00	148.46	149.69	13494.1	903.6	3582.1
136.00	149.55	150.78	13593.0	904.1	3666.2
137.00	150.61	151.85	13689.2	904.6	3749.4
138.00	151.63	152.89	13782.7	905.0	3831.3
139.00	152.63	153.89	13872.9	905.4	3911.4
140.00	153.58	154.85	13959.5	905.8	3989.5
141.00	154.49	155.77	14042.3	906.2	4065.0
142.00	155.36	156.64	14120.9	906.6	4137.6
143.00	156.17	157.46	14195.0	907.0	4206.7
144.00	156.93	158.23	14264.2	907.3	4272.0
145.00	157.64	158.94	14328.2	907.6	4333.0
146.00	158.28	159.59	14386.7	907.9	4389.2
147.00	158.86	160.17	14439.4	908.1	4440.2

Table 4.1-1 (Continued)

OXIDIZER SUMP TANK

HEIGHT OF PROPELLANT	TANK VOLUME UNSTRECHED	TANK VOLUME STRECHED	MASS OF PROPELLANT	CENTER OF MASS	MOMENT OF INERTIA(IYY)
148.00	159.37	160.69	14485.8	908.4	4485.5
149.00	159.81	161.13	14525.8	908.6	4524.7
150.00	160.17	161.50	14558.9	908.7	4557.4
151.00	160.46	161.78	14584.9	908.9	4583.1
152.00	160.66	161.99	14603.3	909.0	4601.4
153.00	160.78	162.11	14613.9	909.0	4612.0
153.81	160.81	162.14	14616.5	909.0	4614.6

TABLE 4.1-2

TRAPPED SPS MASS PROPERTIES

<u>SERVICE MODULE</u>	Weight Pounds	Center of Gravity Inches		
		X _A	Y _A	Z _A
¹ SPS - Trapped Outside Tanks				
Engine - Fuel	29.6	846.9	6.6	0.4
- Oxidizer	47.4	843.0	-7.1	1.6
Feedline - Fuel	29.5	832.0	-48.0	-25.0
- Oxidizer	44.7	832.0	48.0	25.0
Transfer Line - Fuel	19.5	829.0	-27.0	-24.0
- Oxidizer	31.6	829.0	27.0	24.0
Total Outside Tanks	202.3	836.0	4.5	3.7
² Trapped in Tanks				
Retention Reservoir - Fuel	61.4			
- Oxidizer	97.5			
Vapor - Fuel	6.2			
- Oxidizer	74.0			
Total Inside Tanks	239.1			

¹ SPS propellant trapped outside tanks should be subtracted from the total SPS propellant load for a particular mission to arrive at the tanked SPS propellant. This tanked amount is then used in the preceding tables to arrive at the appropriate SPS propellant Mass Properties.

² The total SPS propellant load for a particular mission less trapped in tanks and outside tanks equals nominal deliverable SPS propellant.

TABLE 4.1-3

SPS Propellant Density Equations (S/C 107 and Subsequent)

Equations for calculating SPS fuel and oxidizer densities are given below. In order to calculate the density for fuel or oxidizer of a given load on a particular mission using the measured density furnished by KSC the following steps are necessary:

- A. Use the appropriate equation below and calculate the fuel or oxidizer density at the given pressure and temperature of the KSC sample. This will usually be 14.7 PSIA and 25°C for fuel, and 14.7 PSIA and 4°C for oxidizer.
- B. Use the appropriate equation below and calculate the fuel or oxidizer density at the final system pressure and temperature. This will usually be 110±5 PSIA and 70±5°F.
- C. Subtract the density obtained in step A from the measured density of the KSC sample, and add this amount (may be either positive or negative) to the density obtained from step B.

A-50 DENSITY EQUATION

$$\rho_F = [57.6095 - 0.058533(^{\circ}\text{C})](C_F)$$

where: ρ_F = A-50 density in lb/ft³

$^{\circ}\text{C}$ = Temperature in degrees centigrade

C_F = Compressibility factor - obtain this number from the pressure - compressibility graph on Figure 4.1-1 of this section.

N₂O₄ DENSITY EQUATION

$$\rho_O = [93.1048 - 0.14252(^{\circ}\text{C})](C_O)$$

where: ρ_O = N₂O₄ density in lb/ft

$^{\circ}\text{C}$ = Temperature in degrees centigrade

C_O = Compressibility factor - obtain this number from the pressure - compressibility graph on Figure 4.1-2 of this section.



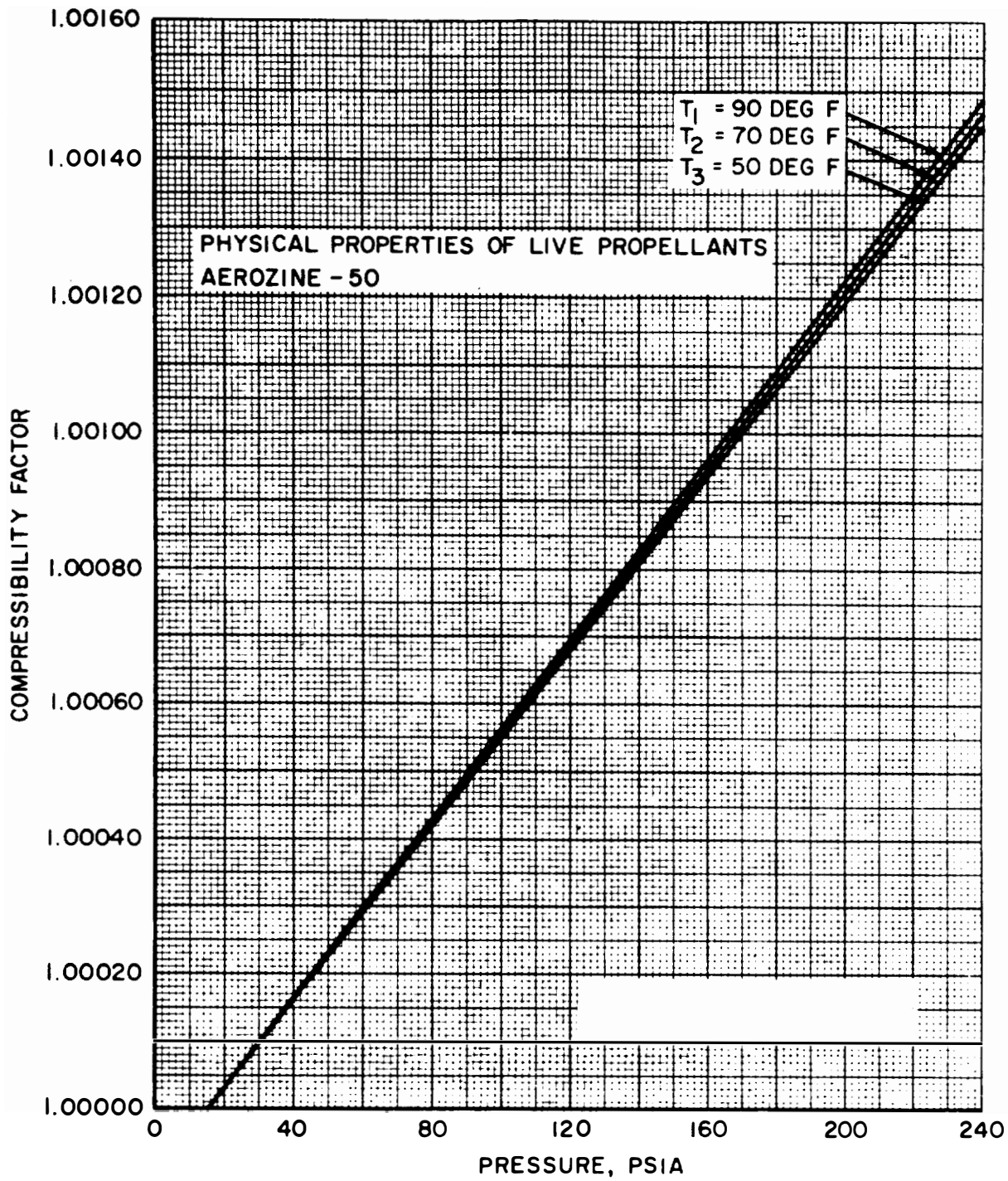

FIGURE 4.1-1 Aerozine-50 Compressibility Correction Factor

M U L T I P L I C A T I O N S

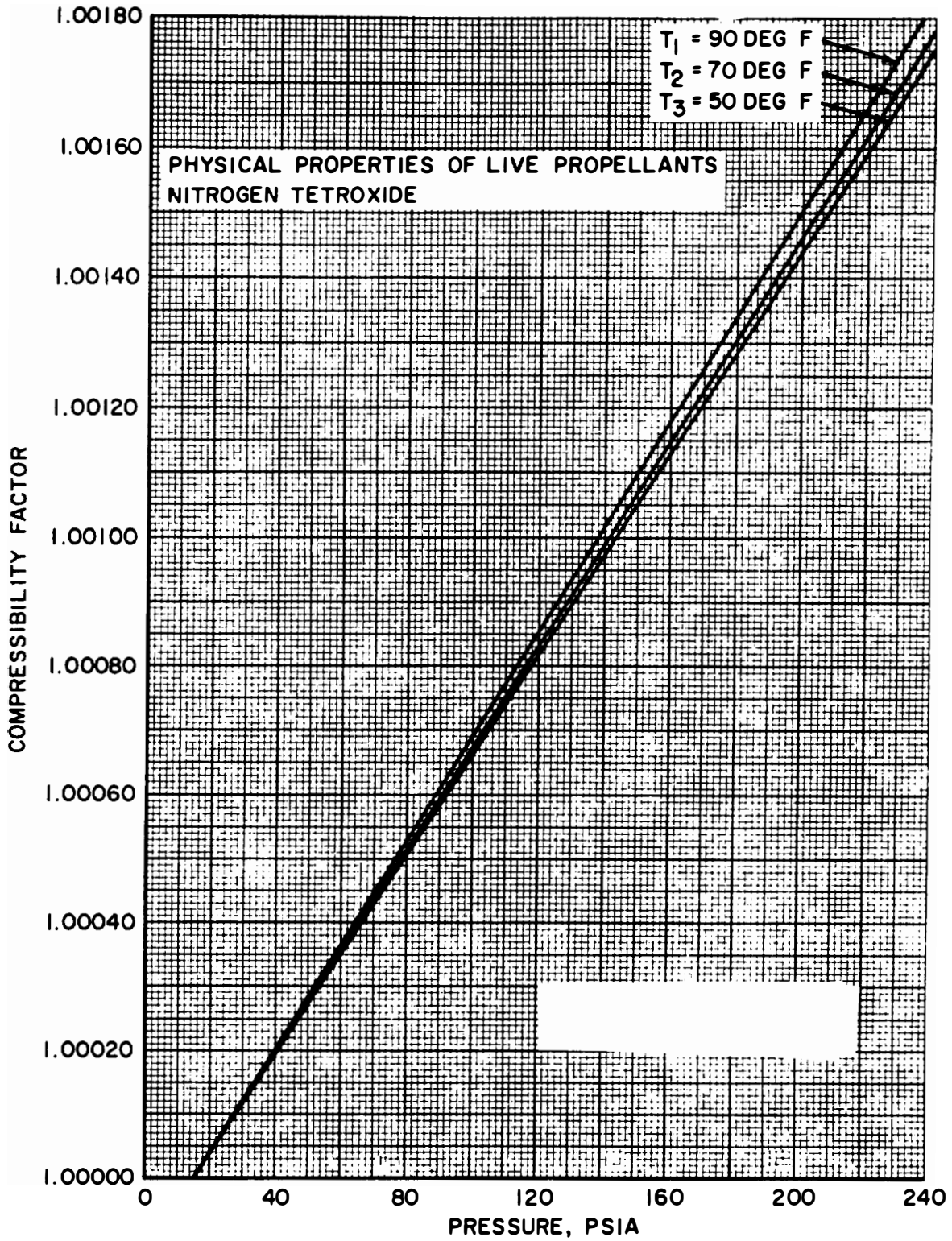

FIGURE 4.1-2 Nitrogen Tetroxide Compressibility Correction Factor

U U U U U U U U U U U U U U U U U U

FUEL

FOR ULLAGE LOADING PRESSURE OF 110±4 PSIA

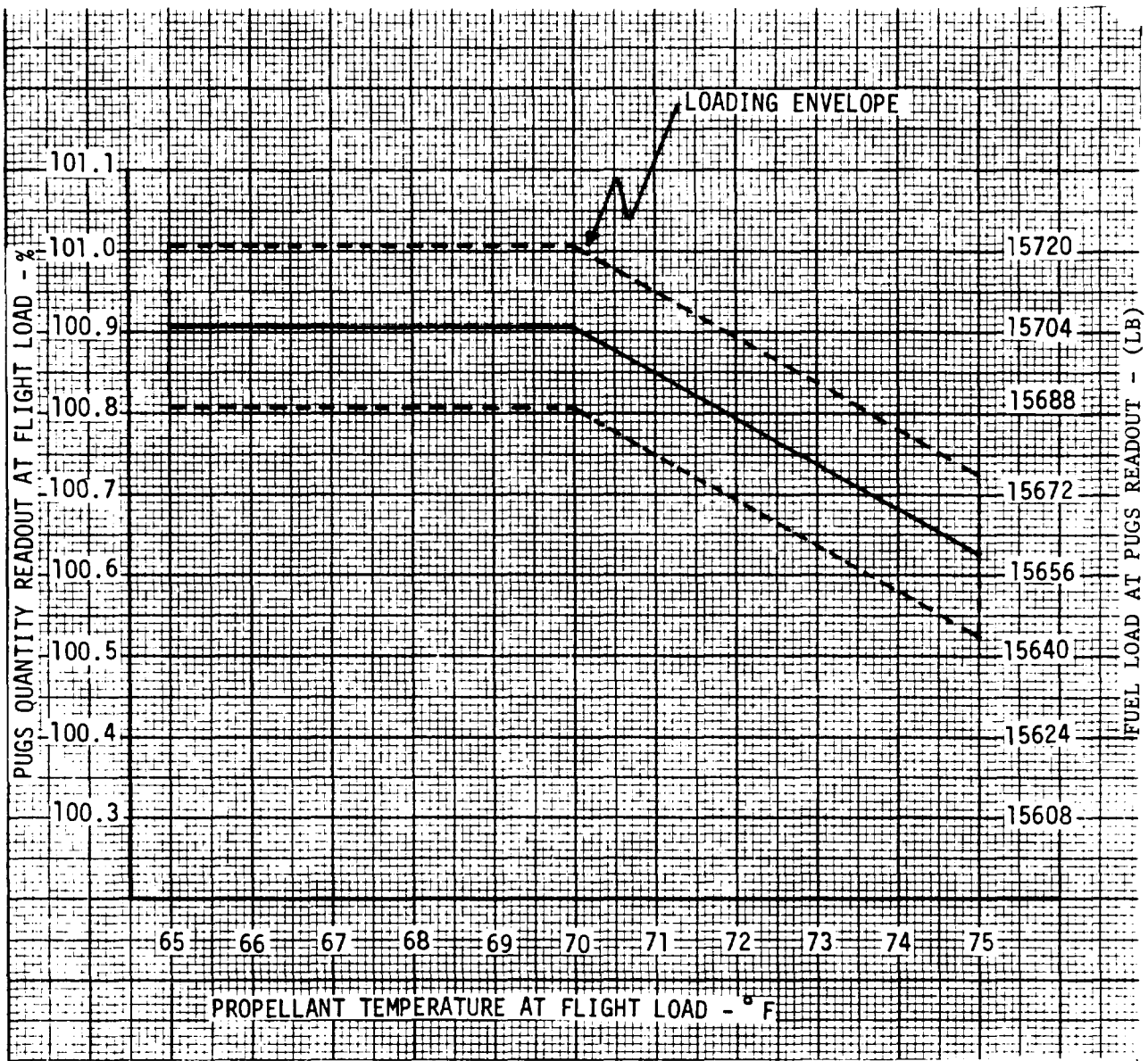

Figure 4.1-3

SERVICE MODULE SPS OXIDIZER LOADING WINDOW FOR SM 107 AND SUBSEQUENT

OXIDIZER

FOR ULLAGE LOADING PRESSURE OF 110±4 PSIA



Figure 4.1-4

U U U E E E L L L E E E U U U U U U U U U U U U

U U

U U U U U U U U U U U U U U U U U U

U U U U U U U U U U U U U U U U U U

U U U U U U U U U U U U U U U U U U

4.2 RCS/ECS/EPS
CONSUMABLES

U U U U U U U U U U U U U U U U U U

U U U U U U U U U U U U U U U U U U

Volume II LM Data Book
Subsystem Performance Data - Crew/Equipment

4.2 CREW/EQUIPMENT

4.2.1 Food Requirement

Each man requires 3200 calories of food per day.

4.2.2 Sensory Limits

Deleted (NASA DATA SOURCE)

4.2.3 PLSS Condensate Transfer Assembly

The PLSS Condensate Transfer Assembly accommodates a maximum of 5190 cc of liquid condensate. The maximum value of condensate fluid from a single PLSS discharge shall be 4400 cc of which a maximum of 865 cc shall be liquid.

The PLSS Condensate Transfer Assembly operational temperature is 35°F to 135°F. The relief valve cracking pressure is 2.1 to 2.9 psid. The full open pressure is 3.8 psid.

The rate of flow of condensate from the PLSS to the PLSS Condensate Transfer Assembly is from 0 cc/sec to 100 cc/sec. The maximum flow rate for "all water" transfer is 25 cc/sec. The maximum flow rate for all gas is 100 cc/sec.

4.2.4 Thermal Variations for the MESA

See appropriate S/C Appendix.

4.2.5 Thermal Variation of the Sample Return Containers after Removal from the MESA (NASA DATA SOURCE)

See appropriate S/C Appendix.

4.2.6 Thermal Response of the Lunar Surface Color TV Camera (NASA DATA SOURCE)

See SODB Volume VII (GCTA) for TV Camera Operation and Performance data.

4.2.7 Crew Heat Storage and Temperature Tolerance Limits

Heat storage should be limited to ± 300 Btu. Above 300 Btu, the performance of tasks of mental complexity or high physical demand is sharply reduced. Below -300 Btu, shivering is continuous and very distracting and likely to severely limit performance. Figure 4.2-1 indicates these areas as the limited tolerance hot and cold zones. Between these zones tolerance is not time limited.



Volume II LM Data Book
Subsystem Performance Data-Crew/Equipment

4.2.8 Data Acquisition Camera (DAC) and Film Canisters Thermal Response

See Table 3.10-2 and appropriate spacecraft appendix.

4.2.9 Quad III Stowage Temperature Predictions

Temperature predictions were made for the LM-10 and LM-11 pallet configurations using the worst hot and cold case vehicle orientations allowable within the thermal design mission. The mission timelines used are described in Figure 4.2-6. The temperature profiles of each pallet are presented in Figures 4.2-2 through 4.2-5. It should be noted that the temperatures indicated are average temperatures derived from a lumped one-node representation of each pallet and its equipment. In reality, local equipment temperatures could vary as much as 15°F from the predicted average pallet temperature. The only difference between the two networks used for the calculations is the thermal mass of each pallet. Temperature responses for LM-12 pallet are expected to be less severe than those of LM-11 because of the increased pallet weights for LM-12.

Temperature predictions for the actual mission profiles are contained in the individual spacecraft appendices.

Reference: LMO 510-1765, LM-10 through LM-12 Quad III Stowage Temperature Predictions for a two Pallet Flight Configuration, dated 11 January 1971.

4.2.10 Waste Management System

The waste management system consists of a containerized waste management tank in the descent stage, and urine receptacles and transfer hoses in the cabin. An analysis has shown worst case operating temperatures of the cabin items between 45°F and 100°F, well within the qualification test temperature range of 35°F to 135°F (see Figure 4.2-7). The containerized waste management tank has a capacity of 5.0 gallons (40 lbs.) to accommodate urine and PLSS condensate which are fed through a line from the cabin. The tank has a primary vent valve which opens at 2.5 psia into a tube, leading to the outside of the vehicle. A secondary valve opens at 3.75 psia and empties into the quad IV bay. An analysis shows worst case operating temperatures without heater use to be 40°F to 120°F, well within qualification test temperatures of 35°F to 160°F (see Figure 4.2-8). Two 15-watt redundant heater systems are provided to heat inlet and outlet ports, and are planned for use shortly before, after, and during container filling.

Contract No. NAS 9-1100
Primary No. 664

Grumman Aerospace Corporation
4.2-1.1

LED-540-54

TABLE 4.2-1 (CONTINUED)

	Weight Pounds	(Center of Gravity Inches		
		X _A	Y _A	Z _A
Deliverable (6)				
Quad A - Primary Fuel	68.5±0.8	964.8	8.0	-68.5
- Secondary Fuel	39.6±0.8	985.1	-7.0	-69.0
- Oxidizer	220.9±3.4	926.9	8.0	-68.5
Quad B - Primary Fuel	68.5±0.8	964.8	64.5	-26.5
- Secondary Fuel	39.6±0.8	985.1	68.0	-11.0
- Oxidizer	220.9±3.4	926.9	64.5	-26.5
Quad C - Primary Fuel	68.5±0.8	964.8	-8.0	68.5
- Secondary Fuel	39.6±0.8	985.1	7.0	69.0
- Oxidizer	220.9±3.4	926.9	-8.0	68.5
Quad D - Primary Fuel	68.5±0.8	964.8	-64.5	26.5
- Secondary Fuel	39.6±0.8	985.1	-68.0	11.0
- Oxidizer	220.9±3.4	926.9	-64.5	26.5
Deliverable Primary Fuel	274.0±1.6	964.8	0.0	0.0
Secondary Fuel	158.4±1.6	985.1	0.0	0.0
Oxidizer	883.6±6.8	926.9	0.0	0.0
Deliverable Fuel	432.4±2.3	972.9	0.0	0.0
Oxidizer	883.6±6.8	926.9	0.0	0.0
Total Deliverable (6)	1316.0±7.2	942.1	0.0	0.0



TABLE 4.2-1 (CONTINUED)

CSM 112 AND SUBSEQUENT MISCELLANEOUS CONSUMABLES

CSM MISCELLANEOUS CONSUMABLES	WEIGHT POUNDS	CENTER OF GRAVITY INCHES		
		X _A	Y _A	Z _A
CM/RCS - HELIUM	1.0	1022.6	-3.1	25.8
CM/ECS				
Oxygen - Entry	(7)	1031.1	-26.9	-34.2
Potable Water (3)	(7)	1022.6	-63.5	-16.4
Waste Water (4)	(7)	1022.6	-19.7	62.5
SM/RCS - Helium	6.0	983.9	0.0	0.0
SM/SPS Helium - Storage Bottles	87.6	954.7	0.0	0.0
- Tanks (5)	5.4	976.0	2.7	8.9
SM/Nitrogen	1.3	874.0	0.0	0.0
SM/EPS/ECS				
Oxygen - Hydrogen ¹				
H ₂ Tank 3	29.3	974.6	37.0	-46.0
H ₂ Tank 2	29.3	859.4	-40.7	41.2
H ₂ Tank 1	29.3	892.9	-40.7	41.2
O ₂ Tank 1	330.1	920.8	-20.9	26.9
O ₂ Tank 2	330.1	920.8	-27.4	54.5
O ₂ Tank 3	330.1	938.0	22.5	-30.0
Total - H ₂	87.9	909.0	-14.8	12.1
- O ₂	990.3	926.6	-8.6	17.1
Total on Board	1078.2	925.1	-9.1	16.7
Unusable - H ₂	1.2	974.6	37.0	-46.0
- H ₂	1.2	859.4	-40.7	41.2
- H ₂	1.2	892.9	-40.7	41.2
- O ₂	6.6	920.8	-20.9	26.9
- O ₂	6.6	920.8	-27.4	54.5
- O ₂	6.6	938.0	22.5	-30.0
Unusable - H ₂	3.6	909.0	-14.8	12.1
- O ₂	19.8	926.6	-8.6	17.1
Total Unusable	23.4	923.8	-9.6	16.4
Usable - H ₂	28.1	974.6	37.0	-46.0
- H ₂	28.1	859.4	-40.7	41.2
- H ₂	28.1	892.9	-40.7	41.2
- O ₂	323.5	920.8	-20.9	26.9
- O ₂	323.5	920.8	-27.4	54.5
- O ₂	323.5	938.0	22.5	-30.0
Usable - H ₂	84.3	909.0	-14.8	12.1
- O ₂	970.5	926.6	-8.6	17.1
Total Usable	1054.8	925.1	-9.1	16.7

¹Nominal Loading. For Liftoff values see individual Mission Section.



Table 4.2-1 (Continued)

CSM 112 and Subsequent Miscellaneous Consumables

CSM MISCELLANEOUS CONSUMABLES	WEIGHT POUNDS	CENTER OF GRAVITY INCHES		
		X _A	Y _A	Z _A
CM/RCS - HELIUM	1.0	1022.6	-3.1	25.8
CM/ECS				
Oxygen - Entry	(7)	1031.1	-26.9	-34.2
Potable Water (3)	(7)	1022.6	-63.5	-16.4
Waste Water (4)	(7)	1022.6	-19.7	62.5
SM/RCS - Helium	6.0	983.9	0.0	0.0
SM/SPS Helium - Storage Bottles	87.6	954.7	0.0	0.0
- Tanks (5)	5.4	976.0	2.7	8.9
SM/Nitrogen	1.3	874.0	0.0	0.0
SM/EPS/ECS				
Oxygen - Hydrogen ¹				
H ₂	29.3	974.6	37.0	-46.0
H ₂	29.3	859.4	-40.7	41.2
H ₂	29.3	892.9	-40.7	41.2
O ₂	330.1	920.8	-20.9	26.9
O ₂	330.1	920.8	-27.4	54.5
O ₂	330.1	938.0	22.5	-30.0
Total - H ₂	87.9	909.0	-14.8	12.1
- O ₂	990.3	926.6	-8.6	17.1
Total on Board	1078.2	925.1	-9.1	16.7
Unusable - H ₂	1.2	974.6	37.0	-46.0
- H ₂	1.2	859.4	-40.7	41.2
- H ₂	1.2	892.9	-40.7	41.2
- O ₂	6.6	920.8	-20.9	26.9
- O ₂	6.6	920.8	-27.4	54.5
- O ₂	6.6	938.0	22.5	-30.0
Unusable - H ₂	3.6	909.0	-14.8	12.1
- O ₂	19.8	926.6	-8.6	17.1
Total Unusable	23.4	923.8	-9.6	16.4
Usable - H ₂	28.1	974.6	37.0	-46.0
- H ₂	28.1	859.4	-40.7	41.2
- H ₂	28.1	892.9	-40.7	41.2
- O ₂	323.5	920.8	-20.9	26.9
- O ₂	323.5	920.8	-27.4	54.5
- O ₂	323.5	938.0	22.5	-30.0
Usable - H ₂	84.3	909.0	-14.8	12.1
- O ₂	970.5	926.6	-8.6	17.1
Total Usable	1054.8	925.1	-9.1	16.7

¹Nominal Loading. For Liftoff values see individual Mission Section.



TABLE 4.2-1
CSM - CONSUMABLE LOADS AND UNCERTAINTIES

This table contains the consumable loads, associated tolerances, and/or uncertainties at nominal loading temperatures and pressures.

	WEIGHT POUNDS	(1) CENTER OF GRAVITY INCHES		
		X _A	Y _A	Z _A
COMMAND MODULE				
Nominal Load				
RCS (2)				
Loaded System 1 - Fuel	44.2±0.9	1022.6	-38.7	52.8
System 1 - Oxidizer	78.3±1.6	1022.6	26.6	59.8
System 2 - Fuel	44.2±0.9	1022.6	-52.8	38.7
System 2 - Oxidizer	78.3±1.6	1022.6	2.3	65.5
Loaded - Fuel	88.4±1.3	1022.6	-45.8	45.8
- Oxidizer	156.6±2.3	1022.6	14.5	62.7
Total Loaded	245.0±2.6	1022.6	-7.3	57.0
Maximum Trapped				
System 1 - Fuel	6.9	1022.6	-38.7	52.8
System 1 - Oxidizer	11.7	1022.6	26.6	59.8
System 2 - Fuel	6.4	1022.6	-52.8	38.7
System 2 - Oxidizer	11.4	1022.6	2.3	65.5
Trapped - Fuel	13.3	1022.6	-45.5	46.0
- Oxidizer	23.1	1022.6	14.6	62.6
Total Trapped (Maximum)	36.4	1022.6	-7.3	56.5
Deliverable (6)				
System 1 - Fuel	37.3±0.9	1022.6	-38.7	52.8
System 1 - Oxidizer	66.6±1.6	1022.6	26.6	59.8
System 2 - Fuel	37.8±0.9	1022.6	-52.8	38.7
System 2 - Oxidizer	66.9±1.6	1022.6	2.3	65.5
Deliverable - Fuel	75.1±1.3	1022.6	-45.8	45.7
- Oxidizer	133.5±2.3	1022.6	14.4	62.7
Total Deliverable	208.6±2.6	1022.6	-7.3	56.5



Table 4.2-1(Continued)

SERVICE MODULE - Nominal Load RCS(2)	Weight Pounds	(1)Center of Gravity Inches		
		X _A	Y _A	Z _A
Quad A - Loaded Primary - Fuel	69.9±0.8	964.8	8.0	-68.5
Secondary-Fuel	40.3±0.8	985.1	-7.0	-69.0
Oxidizer	225.4±3.4	926.9	8.0	-68.5
Quad B - Loaded Primary - Fuel	69.9±0.8	964.8	64.5	-26.5
Secondary-Fuel	40.3±0.8	985.1	68.0	-11.0
Oxidizer	225.4±3.4	926.9	64.5	-26.5
Quad C - Loaded Primary - Fuel	69.9±0.8	964.8	-8.0	68.5
Secondary-Fuel	40.3±0.8	985.1	7.0	69.0
Oxidizer	225.4±3.4	926.9	-8.0	68.5
Quad D - Loaded Primary - Fuel	69.9±0.8	964.8	-64.5	26.5
Secondary-Fuel	40.3±0.8	985.1	-68.0	11.0
Oxidizer	225.4±3.4	926.9	-64.5	26.5
Loaded Primary - Fuel	279.6±1.6	964.8	0.0	0.0
Secondary-Fuel	161.2±1.6	985.1	0.0	0.0
Oxidizer	901.6±6.8	926.9	0.0	0.0
Loaded - Fuel	440.8±2.3	972.9	0.0	0.0
-Oxidizer	901.6±6.8	926.9	0.0	0.0
TOTAL LOADED	1342.4±7.2	942.1	0.0	0.0
Max. Trapped--Quad A - Primary Fuel	1.4	964.8	8.0	-68.5
- Secondary Fuel	0.7	985.1	-7.0	-69.0
- Oxidizer	4.5	926.9	8.0	-68.5
Quad B - Primary Fuel	1.4	964.8	64.5	-26.5
- Secondary Fuel	0.7	985.1	68.0	-11.0
- Oxidizer	4.5	926.9	64.5	-26.5
Quad C - Primary Fuel	1.4	964.8	-8.0	68.5
- Secondary Fuel	0.7	985.1	7.0	69.0
- Oxidizer	4.5	926.9	-8.0	68.5
Quad D - Primary Fuel	1.4	964.8	-64.5	26.5
- Secondary Fuel	0.7	985.1	-68.0	11.0
- Oxidizer	4.5	926.9	-64.5	26.5
Trapped Primary Fuel	5.6	964.8	0.0	0.0
Secondary Fuel	2.8	985.1	0.0	0.0
Oxidizer	18.0	926.9	0.0	0.0
Trapped Fuel	8.4	971.6	0.0	0.0
Oxidizer	18.0	926.9	0.0	0.0
TOTAL TRAPPED (MAXIMUM)	26.4	940.9	0.0	0.0



TABLE 4.2-2 (Continued)

SM RCS QUAD D MASS PROPERTIES

The following table presents the mass properties for SM RCS Quad D as a function of propellant remaining. For all weights Y-c.g. = -64.9 inches
 IXX = 0.0, PXY = PYZ = 0.0.

TOTAL WT. Pounds	X-c.g. Inches	Z-c.g. Inches	IYY Slug Ft ²	IZZ Slug Ft ²	PXZ Slug Ft ²	PROPELLANT REMAINING (Pounds)			
						Pri. Fuel	Sec. Fuel	Pri. Oxidizer	Sec. Oxidizer
335.6	941.8	24.6	46.9	45.2	-5.8	69.9	40.3	140.4	85.0
326.6	941.9	24.6	45.8	44.1	-5.8	66.9	40.3	137.4	82.0
317.6	942.0	24.5	44.8	43.0	-5.8	63.9	40.3	134.4	79.0
308.6	942.2	24.5	43.7	41.9	-5.8	60.9	40.3	131.4	76.0
299.6	942.3	24.4	42.6	40.9	-5.8	57.9	40.3	128.4	73.0
290.6	942.5	24.4	41.5	39.8	-5.7	54.9	40.3	125.4	70.0
281.6	942.7	24.3	40.4	38.7	-5.7	51.9	40.3	122.4	67.0
272.6	942.9	24.2	39.3	37.6	-5.7	48.9	40.3	119.4	64.0
263.6	943.0	24.1	38.2	36.5	-5.7	45.9	40.3	116.4	61.0
254.6	943.3	24.1	37.1	35.4	-5.6	42.9	40.3	113.4	58.0
245.6	943.5	24.0	36.0	34.3	-5.6	39.9	40.3	110.4	55.0
236.6	943.7	23.9	34.8	33.2	-5.6	36.9	40.3	107.4	52.0
227.6	944.0	23.8	33.7	32.1	-5.5	33.9	40.3	104.4	49.0
218.6	944.3	23.6	32.6	31.0	-5.5	30.9	40.3	101.4	46.0
209.6	944.6	23.5	31.4	29.8	-5.5	27.9	40.3	98.4	43.0
200.6	944.9	23.4	30.3	28.7	-5.4	24.9	40.3	95.4	40.0
191.6	945.3	23.2	29.1	27.5	-5.4	21.9	40.3	92.4	37.0
182.6	945.7	23.1	27.9	26.4	-5.3	18.9	40.3	89.4	34.0
173.6	946.1	22.9	26.7	25.2	-5.3	15.9	40.3	86.4	31.0
164.6	946.6	22.7	25.5	24.0	-5.2	12.9	40.3	83.4	28.0
155.6	947.2	22.5	24.3	22.8	-5.1	9.9	40.3	80.4	25.0
146.6	947.8	22.2	23.0	21.5	-5.0	6.9	40.3	77.4	22.0
137.6	948.5	22.0	21.7	20.3	-4.9	3.9	40.3	74.4	19.0
130.1	949.1	21.7	20.6	19.2	-4.8	1.4	40.3	71.9	16.5
121.1	949.5	21.7	18.5	17.2	-4.4	1.4	37.3	68.9	13.5
112.1	950.0	21.8	16.4	15.2	-4.0	1.4	34.3	65.9	10.5
103.1	950.5	21.8	14.3	13.2	-3.6	1.4	31.3	62.9	7.5
86.6	951.8	21.9	10.3	9.4	-2.9	1.4	25.8	57.4	2.0
77.6	951.6	22.0	9.3	8.5	-2.6	1.4	22.8	51.4	2.0
68.6	951.3	22.0	8.2	7.5	-2.2	1.4	19.8	45.4	2.0
59.6	950.9	22.1	7.1	6.5	-1.9	1.4	16.8	39.4	2.0
50.6	950.4	22.3	6.0	5.5	-1.6	1.4	13.8	33.4	2.0
41.6	949.7	22.5	4.9	4.6	-1.3	1.4	10.8	27.4	2.0
32.6	948.6	22.8	3.8	3.6	-1.0	1.4	7.8	21.4	2.0
23.6	946.7	23.4	2.7	2.5	-0.6	1.4	4.8	15.4	2.0
11.3	939.0	25.5	1.0	0.9	-0.1	1.4	0.7	7.2	2.0

U U E



U U U U U U U U U U U U U U U U U U

U U U U U U U U U U U U U U U U U U

U U U U U U U U U U U U U U U U U U

U U U U U U U U U U U U U U U U U U

U U U U U U U U U U U U U U U U U U

4.3 GSM/RCS
LOADING REFERENCES

U U U U U U U U U U U U U U U U U U

4.3 CM/RCS AND SM/RCS LOAD CALCULATION TABLES AND LOADING WINDOWS

4.3.1 CM/RCS

Table 4.3-1 is the CM/RCS load calculation table to be completed by KSC for each mission. Figures 4.3-4 and 4.3-5 are the CM/RCS fuel and oxidizer loading windows to be used by KSC for Mission F and subsequent.

4.3.2 SM/RCS

Table 4.3-2 is the SM/RCS load summary table to be completed by KSC for each mission. Tables 4.3-3 through 4.3-6 are the load calculation tables to be used by KSC to transmit to MSC the PV parameters and calculations for each quad. All of these tables are mission independent. Figures 4.3-1 through 4.3-3 are the SM/RCS loading windows to be used by KSC for Mission F and subsequent.

4.3.3 CSM/RCS Mass Calculations for Horizontal Tanks

The primary method for determining the amount of RCS propellant loaded in the CSM horizontal tanks is by actual propellant weight as determined by using the bleed unit scales. The weight as determined by the bleed unit scales is verified by PV calculation as outlined in Tables 4.3-1, and 4.3-3 through 4.3-6. If for an individual tank the propellant weight as determined by the bleed unit scales and the propellant weight as determined by the PV calculation do not correlate, then KSC, ASPO, and the appropriate sub-system manager will jointly determine which of the above methods will be used.

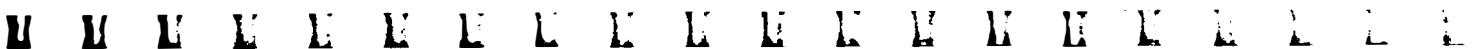

TABLE 4.3-1
 COMMAND MODULE RCS LOADING REQUIREMENTS,
 PARAMETERS AND CALCULATIONS

	<u>Load Parameters and Calculations</u>			
	<u>Fuel</u>		<u>Oxidizer</u>	
	<u>Tank A</u>	<u>Tank B</u>	<u>Tank A</u>	<u>Tank B</u>
A. Tank Volume @ 0.0 PSIG (in ³)	_____	_____	_____	_____
A1. Liquid Line Volume (in ³)	_____	_____	_____	_____
A2. Total A + A1 (in ³)	_____	_____	_____	_____
B. Initial Weight in Bleed Unit Prior to Loading (lb)	_____	_____	_____	_____
C. Final Weight in Bleed Unit After Loading (lb)	_____	_____	_____	_____
D. Propellant Load by Weigh Tank; Item B less Item C (lb)	_____	_____	_____	_____
E. Loading Temperature (°F)	_____	_____	_____	_____
F. Specification Load @ 70 ±5°F (lb)	_____	_____	_____	_____
G. Total CM/RCS Propellant Load from Item D above or Item P below (lb)	_____	±0.3	_____	±0.3
<u>Ullage Calculation</u>				
G1. Density (lb/in ³); solve the following equation where T = Temperature in E above and ρ _F = fuel density; ρ _O = oxidizer density.	_____	_____	_____	_____
ρ _F = 0.0329456 - (0.186979)(10 ⁻⁴)(T)				
ρ _O = 0.451591(10 ⁻⁴)(11.8-T)+0.05475906				
H. Specification Ullage @ E above; Maximum	_____	_____	_____	_____
Minimum	_____	_____	_____	_____
I. Tank Stretch Factor (in ³ /PSI)	_____	_____	_____	_____
J. Volume of GHE-GSE Line (in ³)	_____	_____	_____	_____
K. Volume of S/C GHE Line (in ³)	_____	_____	_____	_____
L. GSE Line Pressure (PSIG)	_____	_____	_____	_____
M. Bladder Pressure (PSIG)	_____	_____	_____	_____
N. Stabilized Equilibrium Pressure (PSIG)	_____	_____	_____	_____
O. Ullage Volume (in ³); solve the following equation by substituting the values contained in the above indicated steps.	_____	_____	_____	_____
Ullage Volume = $J \left(\frac{L - N}{N - M} \right) - I (N + M + 14.7) - K$				
P. Propellant load by P.V. (lb)	_____	_____	_____	_____



TABLE 4.3-2

SERVICE MODULE RCS PROPELLANT LOAD SUMMATION

Actual:

QUAD A
(Pounds)

Secondary Fuel	_____		
Primary Fuel	_____	Total Oxidizer	_____ <u>+ 2.3</u>
Total	_____ <u>+ 0.7</u>		

QUAD B
(Pounds)

Secondary Fuel	_____		
Primary Fuel	_____	Total Oxidizer	_____ <u>+ 2.3</u>
Total	_____ <u>+ 0.7</u>		

QUAD C
(Pounds)

Secondary Fuel	_____		
Primary Fuel	_____	Total Oxidizer	_____ <u>+ 2.3</u>
Total	_____ <u>+ 0.7</u>		

QUAD D
(Pounds)

Secondary Fuel	_____		
Primary Fuel	_____	Total Oxidizer	_____ <u>+ 2.3</u>
Total	_____ <u>+ 0.7</u>		

Total SM/RCS Propellant Loaded (1b)

Fuel _____ + 1.4

Oxidizer _____ + 4.6



TABLE 4.3-3

SERVICE MODULE RCS LOADING PARAMETERS AND CALCULATIONS - QUAD A

Fuel

Secondary Fuel

- A. Loading Temperature (°F) _____
- B. Tank Volume (in³) @ 0.0 PSIG _____
- B1. Liquid Line Volume (in³) _____
- C. Tank Stretch Factor (in³/PSI) 0.034
- D. Initial Weight of Bleed Unit Prior to Loading (lb) _____
- E. Final Weight of Bleed Unit After Loading (lb) _____
- *F. Resulting Load (lb) (Item D less Item E) _____
- G. Specification Nominal Load at 70 ±5° F (lb) _____
- H. Volume of GHE-GSE Line (in³) _____
- I. Volume of S/C GHE Line (in³) _____
- J. GSE Line Pressure (PSIG) _____
- K. Bladder Pressure (PSIG) _____
- L. Stabilized Equilibrium Pressure (PSIG) _____
- M. Primary Liquid Close-Out Pressure (PSIG) _____
- N. Specification Ullage @ A Above
Maximum _____
Minimum _____
- O. Ullage Volume (in³). Solve the following equation by substituting the values contained in the indicated steps.

$$\text{Ullage Volume} = H \left(\frac{J - L}{L - K} \right) -$$

$$(C + S)(L + K + 14.7) + S(M) - I$$

Primary Fuel

- P. Loading Temperature (°F) _____
- Q. Tank Volume (in³) @ 0.0 PSIG _____
- R. Liquid Line Volume (in³) _____
- S. Tank Stretch Factor (in³/PSI) 0.0652

Oxidizer

Secondary Oxidizer

- A. Tank Volume (in³) @ 0.0 PSIG _____
- A1. Liquid Line Volume (in³) _____
- B. Tank Stretch Factor (in³/PSI) 0.045

Primary Oxidizer

- C. Tank Volume (in³) @ 0.0 PSIG _____
- C1. Liquid Line Volume (in³) _____
- D. Tank Stretch Factor (in³/PSI) 0.088

PV Parameters for Combined Primary and Secondary Oxidizer Tanks

- E. Volume of GHE-GSE Line (in³) _____
- F. Volume of S/C GHE Line (in³) _____
- G. GSE Line Pressure (PSIG) _____
- H. Bladder Pressure (PSIG) _____
- I. Stabilized Equilibrium Pressure (PSIG) _____
- J. Loading Temperature (°F) _____
- K. Oxidizer Density (lb/in³); solve equation (4) below where T = Temperature @ J above _____
- L. Specification Value @ Temperature J above (lb)
Maximum _____
Minimum _____
- M. PV Calculated Oxidizer Load (lb); solve equation (5) and (6) below by substituting the values contained in the above indicated steps where U = Volume of tank gas (in³) in both tanks and He system, and F₀ = PV calculated oxidizer load for both tanks _____ ±2.3

- N. Specification Nominal Value @ Temperature J above (lb) _____

(4) Oxidizer Density = $0.451591(10^{-4})$
 $(11.8 - T) + 0.05475906$

(5) $U = E \left(\frac{G - I}{I - H} \right) - (B+D)(I+H+14.7)$

(6) $F_0 = K(A + C + A1 + C1 - U + F)$

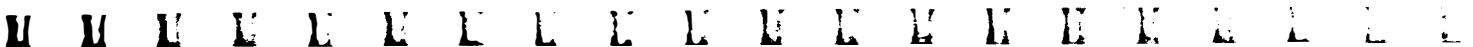

TABLE 4.3-3 (Continued)

SERVICE MODULE RCS LOADING PARAMETERS AND CALCULATIONS - QUAD A

T. Fuel Density (lb/in³); solve equation (1) below where T = Temperature @ P above _____

PV Parameters for Combined Primary and Secondary Fuel Tanks

U. Volume of GHE-GSE Line (in³) _____

V. Volume of S/C GHE Line (in³) _____

W. GSE Line Pressure (PSIG) _____

X. Bladder Pressure (PSIG) _____

Y. Stabilized Equilibrium Pressure (PSIG) _____

Z. Specification PV Value @ Temperature P above (lb)
 Maximum _____
 Minimum _____

Z1. PV calculated fuel load (lb) _____
 Solve equations (2) and (3) below by substituting the values contained in the above indicated steps where U_V = Volume of tanked gas (in³) in the primary tank and F_L = PV calculated fuel load.

Z2. Specification Nominal _____ value @ temperature H above (lb)

Z3. Total fuel load (lb) _____ ±0.7
 (Item F plus Item Z1)

(1) Fuel density = 0.0329456 -
 (0.186979)(10⁻⁴)(T)

(2) $U_V = U \left(\frac{W - Y}{Y - X} \right) - (C + S) (Y + X + 14.7)$

* (3) $F_L = T (Q + R - U_V + V + B + B1 - \frac{F}{T})$

*Z4. Secondary Fuel Load by P.V. (lb) _____

* If secondary fuel load is determined by P.V. calculation, then in Equation Three (3), substitute item Z4 for item F.



TABLE 4.3-4

SERVICE MODULE RCS LOADING PARAMETERS AND CALCULATIONS - QUAD B

<u>Fuel</u>		<u>Oxidizer</u>	
<u>Secondary Fuel</u>		<u>Secondary Oxidizer</u>	
A.	Loading Temperature (°F) _____	A.	Tank Volume (in ³) @ 0.0 PSIG _____
B.	Tank Volume (in ³) @ 0.0 PSIG _____	A1.	Liquid Line Volume (in ³) _____
B1.	Liquid Line Volume (in ³) _____	B.	Tank Stretch Factor (in ³ /PSI) <u>0.045</u>
C.	Tank Stretch Factor (in ³ /PSI) <u>0.034</u>	<u>Primary Oxidizer</u>	
D.	Initial Weight of Bleed Unit Prior to Loading (lb) _____	C.	Tank Volume (in ³) @ 0.0 PSIG _____
E.	Final Weight of Bleed Unit After Loading (lb) _____	C1.	Liquid Line Volume (in ³) _____
F.	Resulting Load (lb) (Item D less Item E) _____	D.	Tank Stretch Factor (in ³ /PSI) <u>0.088</u>
G.	Specification Nominal Load at 70 ±5° F (lb) _____	<u>PV Parameters for Combined Primary and Secondary Oxidizer Tanks</u>	
H.	Volume of GHE-GSE Line (in ³) _____	E.	Volume of GHE-GSE Line (in ³) _____
I.	Volume of S/CGHE Line (in ³) _____	F.	Volume of S/C GHE Line (in ³) _____
J.	GSE Line Pressure (PSIG) _____	G.	GSE Line Pressure (PSIG) _____
K.	Bladder Pressure (PSIG) _____	H.	Bladder Pressure (PSIG) _____
L.	Stabilized Equilibrium Pressure (PSIG) _____	I.	Stabilized Equilibrium Pressure (PSIG) _____
M.	Primary Liquid Close-Out Pressure (PSIG) _____	J.	Loading Temperature (°F) _____
N.	Specification Ullage @ A Above Maximum _____ Minimum _____	K.	Oxidizer Density (lb/in ³); solve equation (4) below where T = Tempera- ture @ J above _____
O.	Ullage Volume (in ³). Solve the following equation by substituting the values contained in the indi- cated steps. _____	L.	Specification Value @ Temperature J above (lb) Maximum _____ Minimum _____
	Ullage Volume = $H \left(\frac{J - L}{L - K} \right) -$ $(C + S)(L + K + 14.7) + S(M) - I$	M.	PV Calculated Oxidizer Load (lb); solve equation (5) and (6) below by sub- stituting the values contained in the above indicated steps where U = Volume of tank gas (in ³) in both tanks and He system, and F _O = PV calculated oxidizer load for both tanks _____ ±2.3
	<u>Primary Fuel</u>	N.	Specification Nominal Value @ Tempera- ture J above (lb) _____
P.	Loading Temperature (°F) _____		(4) Oxidizer Density = $0.451591(10^{-4})$ $(11.8 - T) + 0.05475906$
Q.	Tank Volume (in ³) @ 0.0 PSIG _____		(5) $U = E \left(\frac{G - I}{I - H} \right) - (B+D)(I+H+14.7)$
R.	Liquid Line Volume (in ³) _____		(6) $F_O = K(A + C + A1 + C1 - U + F)$
S.	Tank Stretch Factor (in ³ /PSI) <u>0.0652</u>		



TABLE 4.3-4 (Continued)

SERVICE MODULE RCS LOADING PARAMETERS AND CALCULATIONS - QUAD B

T. Fuel Density (lb/in³); solve equation (1) below where T = Temperature @ P above _____

PV Parameters for Combined Primary and Secondary Fuel Tanks

U. Volume of GHE-GSE Line (in³) _____

V. Volume of S/C GHE Line (in³) _____

W. GSE Line Pressure (PSIG) _____

X. Bladder Pressure (PSIG) _____

Y. Stabilized Equilibrium Pressure (PSIG) _____

Z. Specification PV Value @ Temperature P above (lb)

Maximum _____

Minimum _____

Z1. PV calculated fuel load (lb) _____
Solve equations (2) and (3) below by substituting the values contained in the above indicated steps where U_V = Volume of tanked gas (in³) in the primary tank and F_L = PV calculated fuel load.

Z2. Specification Nominal value @ temperature H above (lb) _____

Z3. Total fuel load (lb) _____ ±0.7
(Item F plus Item Z1)

$$(1) \text{ Fuel density} = 0.0329456 - (0.186979)(10^{-4})(T)$$

$$(2) U_V = U \left(\frac{W - Y}{Y - X} \right) - (C + S) (Y + X + 14.7)$$

$$*(3) F_L = T (Q + R - U_V + V + B + B1 - \frac{F}{T})$$

*Z4. Secondary Fuel Load by P.V. (lb) _____

*If secondary fuel load is determined by P.V. calculation, then in Equation Three (3), substitute item Z4 for item F.



TABLE 4.3-5

SERVICE MODULE RCS LOADING PARAMETERS AND CALCULATIONS - QUAD C

<u>Fuel</u>		<u>Oxidizer</u>	
<u>Secondary Fuel</u>		<u>Secondary Oxidizer</u>	
A.	Loading Temperature (°F) _____	A.	Tank Volume (in ³) @ 0.0 PSIG _____
B.	Tank Volume (in ³) @ 0.0 PSIG _____	Al.	Liquid Line Volume (in ³) _____
Bl.	Liquid Line Volume (in ³) _____	B.	Tank Stretch Factor (in ³ /PSI) <u>0.045</u>
C.	Tank Stretch Factor (in ³ /PSI) <u>0.034</u>	<u>Primary Oxidizer</u>	
D.	Initial Weight of Bleed Unit Prior to Loading (lb) _____	C.	Tank Volume (in ³) @ 0.0 PSIG _____
E.	Final Weight of Bleed Unit After Loading (lb) _____	Cl.	Liquid Line Volume (in ³) _____
*F.	Resulting Load (lb) (Item D less Item E) _____	D.	Tank Stretch Factor (in ³ /PSI) <u>0.088</u>
G.	Specification Nominal Load at 70 ±5° F (lb) _____	<u>PV Parameters for Combined Primary and Secondary Oxidizer Tanks</u>	
H.	Volume of GHE-GSE Line (in ³) _____	E.	Volume of GHE-GSE Line (in ³) _____
I.	Volume of S/C GHE Line (in ³) _____	F.	Volume of S/C GHE Line (in ³) _____
J.	GSE Line Pressure (PSIG) _____	G.	GSE Line Pressure (PSIG) _____
K.	Bladder Pressure (PSIG) _____	H.	Bladder Pressure (PSIG) _____
L.	Stabilized Equilibrium Pressure (PSIG) _____	I.	Stabilized Equilibrium Pressure (PSIG) _____
M.	Primary Liquid Close-Out Pressure (PSIG) _____	J.	Loading Temperature (°F) _____
N.	Specification Ullage @ A Above Maximum _____ Minimum _____	K.	Oxidizer Density (lb/in ³); solve equation (4) below where T = Tempera- ture @ J above _____
O.	Ullage Volume (in ³). Solve the following equation by substituting the values contained in the indi- cated steps. _____	L.	Specification Value @ Temperature J above (lb) Maximum _____ Minimum _____
	Ullage Volume = $H \left(\frac{J - L}{L - K} \right) -$ $(C + S)(L + K + 14.7) + S(M) - I$	M.	PV Calculated Oxidizer Load (lb); solve equation (5) and (6) below by sub- stituting the values contained in the above indicated steps where U = Volume of tank gas (in ³) in both tanks and He system, and F _O = PV calculated oxidizer load for both tanks _____ ±2.3
	<u>Primary Fuel</u>	N.	Specification Nominal Value @ Tempera- ture J above (lb) _____
P.	Loading Temperature (°F) _____		(4) Oxidizer Density = $0.451591(10^{-4})$ $(11.8 - T) + 0.05475906$
Q.	Tank Volume (in ³) @ 0.0 PSIG _____		(5) $U = E \left(\frac{G - I}{I - H} \right) - (B+D)(I+H+14.7)$
R.	Liquid Line Volume (in ³) _____		(6) $F_O = K(A + C + Al + Cl - U + F)$
S.	Tank Stretch Factor (in ³ /PSI) <u>0.0652</u>		

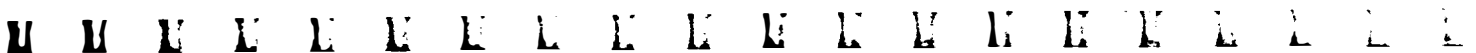

TALBE 4.3-5 (Continued)

SERVICE MODULE RCS LOADING PARAMETERS AND CALCULATIONS - QUAD C

T. Fuel Density (lb/in³); solve equation (1) below where T = Temperature @ P above _____

PV Parameters for Combined Primary and Secondary Fuel Tanks

U. Volume of GHE-GSE Line (in³) _____

V. Volume of S/C GHE Line (in³) _____

W. GSE Line Pressure (PSIG) _____

X. Bladder Pressure (PSIG) _____

Y. Stabilized Equilibrium Pressure (PSIG) _____

Z. Specification PV Value @ Temperature P above (lb)

Maximum _____

Minimum _____

Z1. PV calculated fuel load (lb) _____
Solve equations (2) and (3) below by substituting the values contained in the above indicated steps where U_V = Volume of tanked gas (in³) in the primary tank and F_L = PV calculated fuel load.

Z2. Specification Nominal value @ temperature H above (lb) _____

Z3. Total fuel load (lb) _____ ±0.7
(Item F plus Item Z1)

$$(1) \text{ Fuel density} = 0.0329456 - (0.186979)(10^{-4})(T)$$

$$(2) U_V = U \left(\frac{W - Y}{Y - X} \right) - (C + S)(Y + X + 14.7)$$

$$*(3) F_L = T(Q + R - U_V + V + B + B1 - \frac{F}{T})$$

*Z4. Secondary Fuel Load by P.V. (lb) _____

*If secondary fuel load is determined by P.V. calculation, then in Equation Three (3), substitute item Z4 for item F.



TABLE 4.3-6

SERVICE MODULE RCS LOADING PARAMETERS AND CALCULATIONS - QUAD D

<u>Fuel</u>	<u>Oxidizer</u>
<u>Secondary Fuel</u>	<u>Secondary Oxidizer</u>
A. Loading Temperature (°F) _____	A. Tank Volume (in ³) @ 0.0 PSIG _____
B. Tank Volume (in ³) @ 0.0 PSIG _____	A1. Liquid Line Volume (in ³) _____
B1. Liquid Line Volume (in ³) _____	B. Tank Stretch Factor (in ³ /PSI) <u>0.045</u>
C. Tank Stretch Factor (in ³ /PSI) <u>0.034</u>	<u>Primary Oxidizer</u>
D. Initial Weight of Bleed Unit Prior to Loading (lb) _____	C. Tank Volume (in ³) @ 0.0 PSIG _____
E. Final Weight of Bleed Unit After Loading (lb) _____	C1. Liquid Line Volume (in ³) _____
* F. Resulting Load (lb) (Item D less Item E) _____	D. Tank Stretch Factor (in ³ /PSI) <u>0.088</u>
G. Specification Nominal Load at 70 ±5° F (lb) _____	<u>PV Parameters for Combined Primary and Secondary Oxidizer Tanks</u>
H. Volume of GHE-GSE Line (in ³) _____	E. Volume of GHE-GSE Line (in ³) _____
I. Volume of S/C GHE Line (in ³) _____	F. Volume of S/C GHE Line (in ³) _____
J. GSE Line Pressure (PSIG) _____	G. GSE Line Pressure (PSIG) _____
K. Bladder Pressure (PSIG) _____	H. Bladder Pressure (PSIG) _____
L. Stabilized Equilibrium Pressure (PSIG) _____	I. Stabilized Equilibrium Pressure (PSIG) _____
M. Primary Liquid Close-Out Pressure (PSIG) _____	J. Loading Temperature (°F) _____
N. Specification Ullage @ A Above Maximum _____ Minimum _____	K. Oxidizer Density (lb/in ³); solve equation (4) below where T = Tempera- ture @ J above _____
O. Ullage Volume (in ³). Solve the following equation by substituting the values contained in the indi- cated steps. _____	L. Specification Value @ Temperature J above (lb) Maximum _____ Minimum _____
Ullage Volume = $H \left(\frac{J - L}{L - K} \right) -$ $(C + S)(L + K + 14.7) + S(M) - I$	M. PV Calculated Oxidizer Load (lb); solve equation (5) and (6) below by sub- stituting the values contained in the above indicated steps where U = Volume of tank gas (in ³) in both tanks and He system, and F ₀ = PV calculated oxidizer load for both tanks _____ ±2.3
<u>Primary Fuel</u>	N. Specification Nominal Value @ Tempera- ture J above (lb) _____
P. Loading Temperature (°F) _____	(4) Oxidizer Density = $0.451591(10^{-4})$ $(11.8 - T) + 0.05475906$
Q. Tank Volume (in ³) @ 0.0 PSIG _____	(5) $U = E \left(\frac{G - I}{I - H} \right) - (B+D)(I+H+14.7)$
R. Liquid Line Volume (in ³) _____	(6) $F_0 = K(A + C + A1 + C1 - U + F)$
S. Tank Stretch Factor (in ³ /PSI) <u>0.0652</u>	

TABLE 4.3-6 (Continued)

SERVICE MODULE RCS LOADING PARAMETERS AND CALCULATIONS - QUAD D

T. Fuel Density (lb/in³); solve equation (1) below where T = Temperature @ P above _____

FV Parameters for Combined Primary and Secondary Fuel Tanks

U. Volume of GHE-GSE Line (in³) _____

V. Volume of S/C GHE Line (in³) _____

W. GSE Line Pressure (PSIG) _____

X. Bladder Pressure (PSIG) _____

Y. Stabilized Equilibrium Pressure (PSIG) _____

Z. Specification PV Value @ Temperature P above (lb)

Maximum _____

Minimum _____

Z1. PV calculated fuel load (lb) _____
Solve equations (2) and (3) below by substituting the values contained in the above indicated steps where U_V = Volume or tanked gas (in³) in the primary tank and F_L = PV calculated fuel load.

Z2. Specification Nominal value @ temperature H above (lb) _____

Z3. Total fuel load (lb) ±0.7 (Item F plus Item Z1)

$$(1) \text{ Fuel density} = 0.0329456 - \frac{(0.186979)(10^{-4})(T)}{T}$$

$$(2) U_V = U \left(\frac{W - Y}{Y - X} \right) - (C + S) (Y + X + 14.7)$$

$$*(3) F_L = T (Q + R - U_V + V + B + B1 - \frac{F}{T})$$

*Z4. Secondary Fuel Load by P.V. (lb) _____

*If secondary fuel load is determined by P.V. calculation, then in Equation Three (3), substitute item Z4 for item F.

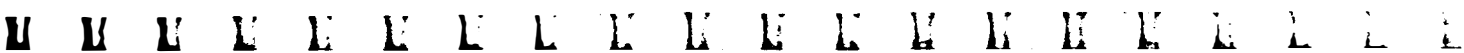

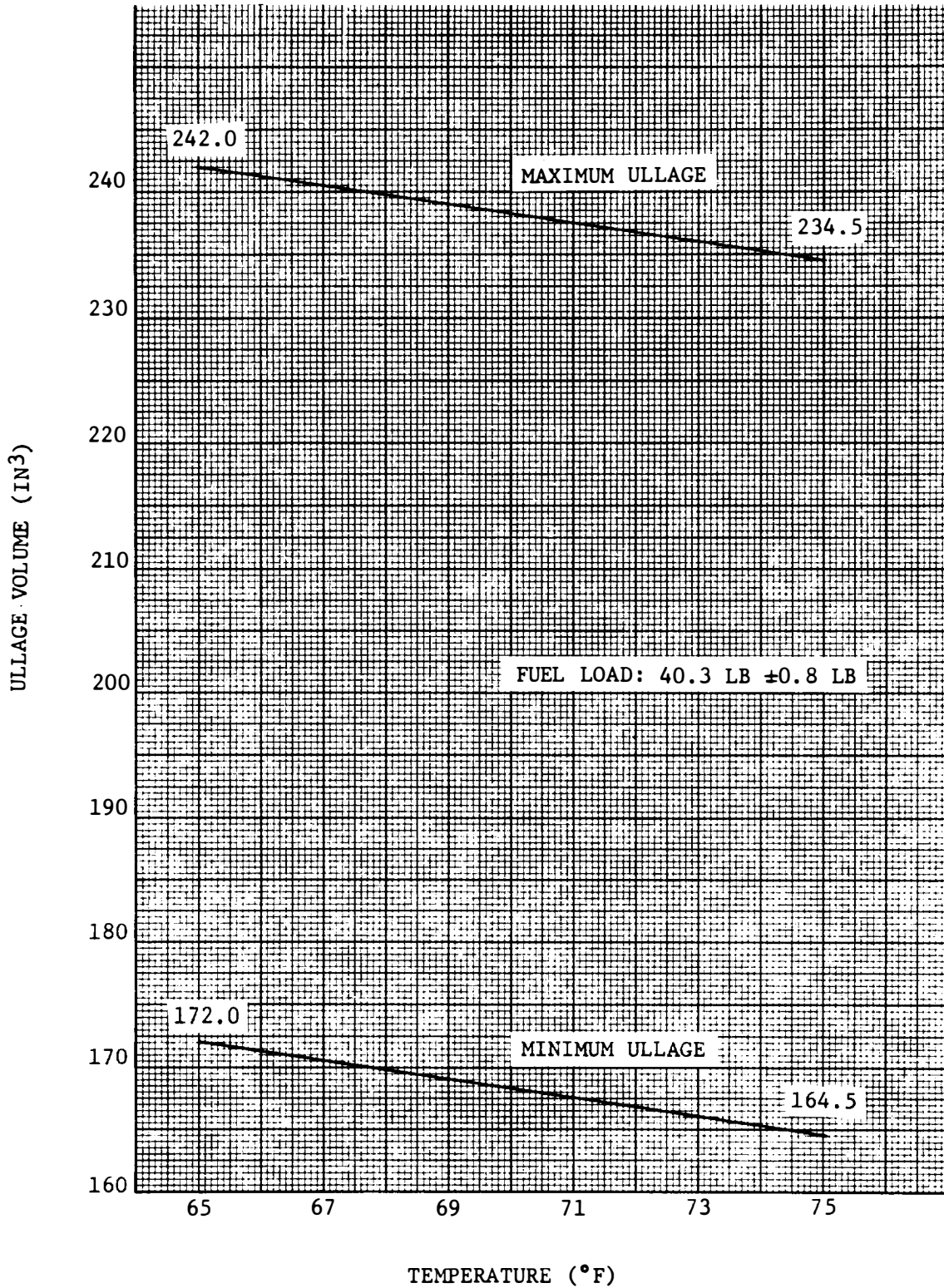

Figure 4.3-1 CSM 104 AND SUBSEQUENT SECONDARY FUEL TANK ULLAGE VOLUME RANGE

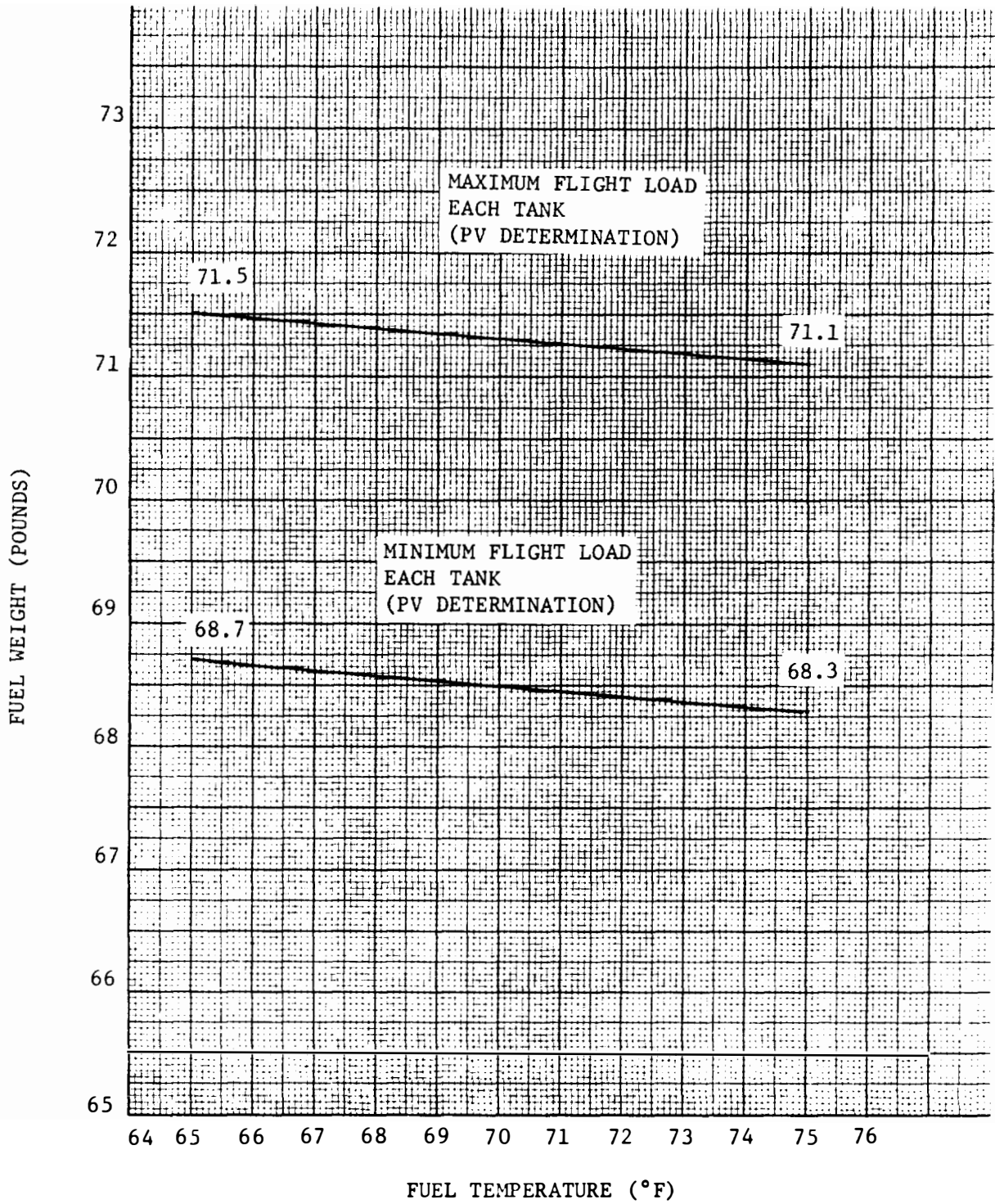

Figure 4.3-2 SM RCS PRIMARY FUEL TANK LOAD WINDOW

U U U E E E E L L L L L L L U U U U U U U

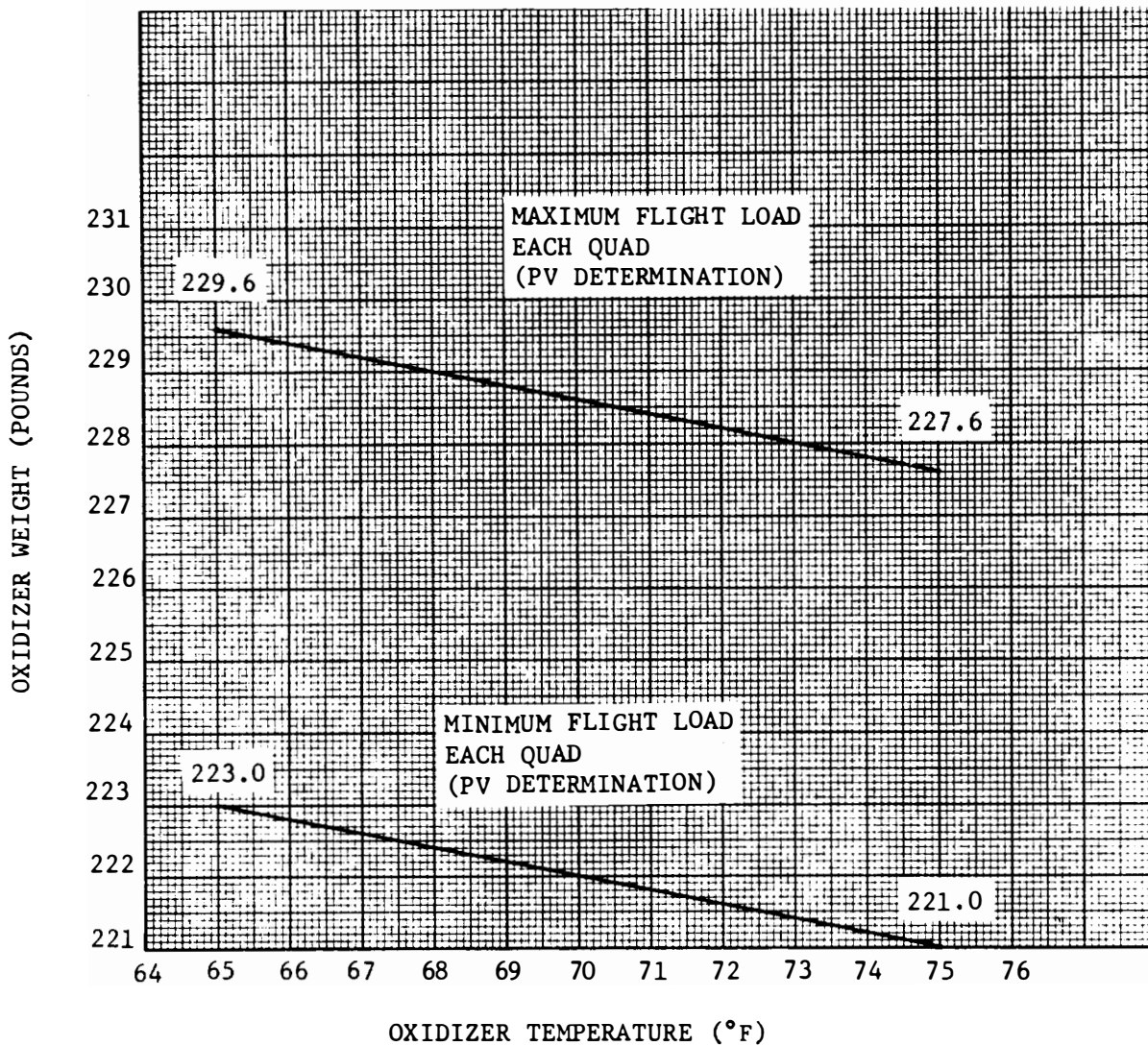
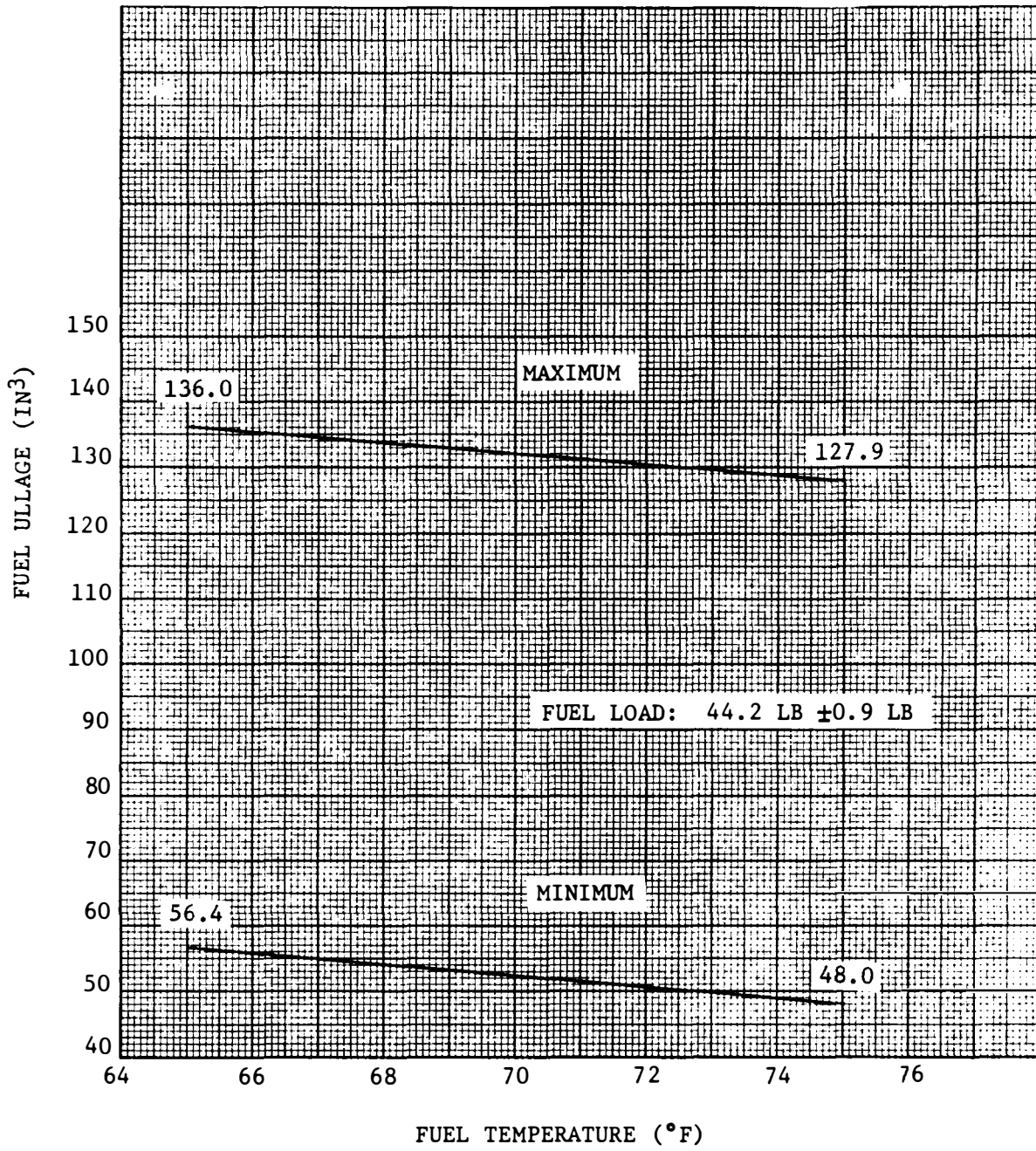
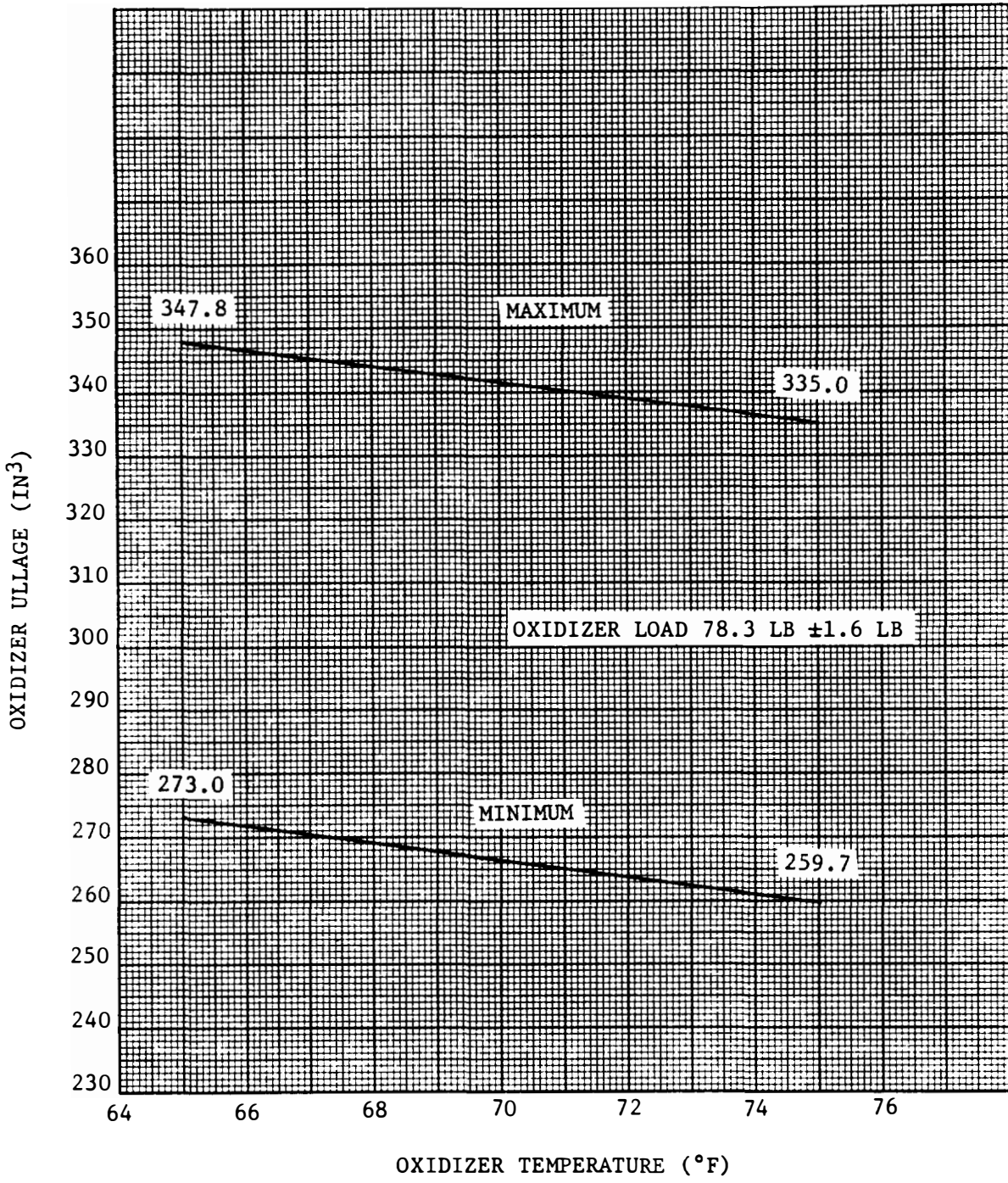

Figure 4.3-3 SM RCS COMBINED PRIMARY-SECONDARY
OXIDIZER TANK LOAD WINDOW

U U



CSM 104 AND SUBSEQUENT CM RCS
 Figure 4.3-4 FUEL TANK ULLAGE VS TEMPERATURE



CSM 104 AND SUBSEQUENT CM RCS
 Figure 4.3-5 OXIDIZER TANK ULLAGE VS TEMPERATURE

M U N I T Y E E L E M E N T A L

TABLE 4.3-10
SERVICE MODULE 113 RCS TANK VOLUMES

<u>System</u>	<u>Serial Number</u>	<u>Gross Tank Volume, in³</u>	<u>Internal Equipment Volume, in³</u>	<u>Net Tank Volume, in³</u>
Quad A				
Primary Oxidizer	100311521170	2857.098	19.1	2837.998
Secondary Oxidizer	100311545125	1802.556	17.8	1784.756
Primary Fuel	100311511168	2267.924	17.4	2250.524
Secondary Fuel	100311537129	1482.432	15.3	1467.132
Quad B				
Primary Oxidizer				
Secondary Oxidizer				
Primary Fuel				
Secondary Fuel				
Quad C				
Primary Oxidizer	100311521171	2862.193	19.1	2843.093
Secondary Oxidizer	100311545101	1815.725	17.8	1797.925
Primary Fuel	100311511170	2272.138	17.4	2254.738
Secondary Fuel	100311537105	1488.499	15.3	1473.199
Quad D				
Primary Oxidizer	100311521331	2861.677	19.1	2842.577
Secondary Oxidizer	100311545100	1784.861	17.8	1767.061
Primary Fuel	100311511333	2269.657	17.4	2252.257
Secondary Fuel	100311537102	1490.003	15.3	1474.703



TABLE 4.3-11
COMMAND MODULE 114 RCS TANK VOLUMES

<u>System</u>	<u>Serial Number</u>	<u>Gross Tank Volume, in³</u>	<u>Internal Equipment Volume, in³</u>	<u>Net Tank Volume, in³</u>
System 1				
Fuel	100311537122	1503.864	15.3	1488.564
Oxidizer	100311545134	1801.085	17.8	1783.285
System 2				
Fuel	100311537114	1461.808	15.3	1446.508
Oxidizer	100311545111	1799.807	17.8	1782.007



4 5 6 7 8 9 10

1 2 3 4 5 6 7 8 9 10

1 2 3 4 5 6 7 8 9 10

1 2 3 4 5 6 7 8 9 10

1 2 3 4 5 6 7 8 9 10

1 2 3 4 5 6 7 8 9 10

5.0 LM REFERENCE
MASS PROPERTIES DATA

1

1

1

1

1

1



Y E L L E E E E E E E E E E E E

Y Y Y Y Y

5.1 LM DESCENT
PROPELLANT TABLES

R R R R R R R R R R R R R R R R

R E I L L X X Y Y Y Y Y Y Y Y Y Y

U U

LUNAR MODULE DESCENT PROPELLANT

MASS PROPERTIES

NOTE:

1. Mass Properties are given for liquid in individual tanks.
2. Moments of Inertia are about center of gravity of propellant in individual tanks, coordinates of which are given.
3. Centers of Gravity in Y and Z directions are given at top of each page.
4. The number of tanks of a particular kind is indicated by the last number on the first line of each page.

U U U E E U E U E U E U U U E E L L L

TABLE 5.1-1
LM-8 DPS FUEL MASS PROPERTIES

Pressure = 235.0 psia
Cylinder Height = 19.28 in.
Density = 56.46 lbs/cu. ft.
Z-CG = 0.0 in.
Pressurized Height = 19.38 in.

Temperature = 70.0°F
Tank Radius = 25.50 in.
Bottom of Tank = 124.96 in.
Y-CG = +/- 54.0 in.
Pressurized Radius = 25.61 in.

Weight (lbs)	XCG (in.)	Inertial (Slug-Ft Sq)		Percent Full	Height (in.)	Rigid (lbs)	Slosh (lbs)	H/2R
		I _{yy}	I _{zz}					
3596.4	160.3	0.00		100.0	70.60	3596.4	0.0	1.38
3560.5	159.5	4.41		99.0	66.81	3386.2	174.3	1.30
3524.5	159.2	6.61		98.0	65.18	3281.8	242.7	1.27
3488.5	159.0	8.49		97.0	63.90	3192.4	296.2	1.25
3452.6	158.9	10.20		96.0	62.80	3109.8	342.8	1.23
3416.6	158.8	11.69		95.0	61.81	3031.0	385.6	1.21
3380.7	158.7	13.06		94.0	60.91	2954.5	426.1	1.19
3344.7	158.7	14.30		93.0	60.07	2879.3	465.4	1.17
3308.7	158.6	15.43		92.0	59.27	2804.9	503.9	1.16
3272.8	158.6	16.32		91.0	58.51	2735.5	537.3	1.14
3236.8	158.5	16.93		90.0	57.79	2672.6	564.2	1.13
3200.8	158.5	17.38		89.0	57.09	2612.0	588.8	1.11
3164.9	158.4	17.67		88.0	56.41	2553.4	611.4	1.10
3128.9	158.4	17.82		87.0	55.75	2496.5	632.4	1.09
3092.9	158.3	17.84		86.0	55.11	2441.0	652.0	1.08
3057.0	158.3	17.72		85.0	54.49	2386.8	670.2	1.06
3021.0	158.2	17.50		84.0	53.87	2333.7	687.3	1.05
2985.0	158.1	17.16		83.0	53.27	2281.6	703.5	1.04
2949.1	158.0	16.74		82.0	52.68	2230.3	718.8	1.03
2913.1	158.0	16.22		81.0	52.10	2179.8	733.3	1.02
2877.1	157.9	15.63		80.0	51.52	2130.0	747.1	1.01
2841.2	157.7	14.93		79.0	50.95	2085.2	756.0	0.99
2805.2	157.6	14.11		78.0	50.39	2045.8	759.5	0.98
2769.3	157.5	13.27		77.0	49.84	2006.7	762.6	0.97
2733.3	157.3	12.41		76.0	49.28	1968.0	755.3	0.96

Amendment 88
10/5/70

TABLE 5.1-1 (CONTINUED)
LM-8 DPS FUEL MASS PROPERTIES

Pressure = 235.0 psia
Cylinder Height = 19.28 in.
Density = 56.46 lbs/cu. ft.
Z-CG = 0.0 in.
Pressurized Height = 19.38 in.

Temperature = 70.0°F
Tank Radius = 25.50 in.
Bottom of Tank = 124.96 in.
Y-CG = +/- 54.0 in.
Pressurized Radius = 25.61 in.

Weight (lbs)	XCG (in.)	Inertial (Slug-Ft Sq)		Percent Full	Height (in.)	Rigid (lbs)	Slosh (lbs)	H/2R
		I _{yy}	I _{zz}					
2697.3	157.2	11.54		75.0	48.74	1929.5	767.8	0.95
2661.4	157.0	10.67		74.0	48.19	1891.3	770.1	0.94
2625.4	156.8	9.80		73.0	47.65	1853.3	772.1	0.93
2589.4	156.7	8.94		72.0	47.11	1815.4	774.0	0.92
2553.5	156.5	8.10		71.0	46.57	1777.7	775.7	0.91
2517.8	156.3	7.28		70.0	46.04	1740.4	777.4	0.90
2481.5	156.1	6.49		69.0	45.50	1702.6	779.0	0.89
2445.5	155.9	5.78		68.0	44.97	1665.9	779.7	0.88
2409.5	155.7	5.18		67.0	44.43	1632.7	776.9	0.87
2373.5	155.6	4.61		66.0	43.90	1599.4	774.2	0.86
2337.7	155.4	4.08		65.0	43.36	1566.2	771.5	0.85
2301.7	155.3	3.60		64.0	42.82	1532.9	768.8	0.84
2265.8	155.1	3.16		63.0	42.28	1499.7	766.1	0.83
2229.8	154.9	2.76		62.0	41.75	1466.4	763.4	0.82
2193.8	154.8	2.39		61.0	41.21	1433.1	760.7	0.80
2157.9	154.6	2.06		60.0	40.67	1399.9	758.0	0.79
2121.9	154.5	1.77		59.0	40.14	1366.6	755.3	0.78
2085.9	154.3	1.51		58.0	39.60	1333.4	752.5	0.77
2050.0	154.2	1.28		57.0	39.06	1300.1	749.8	0.76
2014.0	154.0	1.08		56.0	38.52	1266.9	747.1	0.75
1978.0	153.9	0.91		55.0	37.99	1233.6	744.4	0.74
1942.1	153.7	0.76		54.0	37.45	1200.4	741.7	0.73
1906.1	153.6	0.63		53.0	36.91	1167.1	739.0	0.72
1870.1	153.4	0.52		52.0	36.37	1133.9	736.3	0.71
1834.2	153.3	0.43		51.0	35.84	1100.6	733.6	0.70

TABLE 5.1-1 (CONTINUED)
LM-8 DPS FUEL MASS PROPERTIES

Pressure = 235.0 psia
Cylinder Height = 19.28 in.
Density = 56.46 lbs/cu. ft.
Z-CG = 0.0 in.
Pressurized Height = 19.38 in.

Temperature = 70.0°F
Tank Radius = 25.50 in.
Bottom of Tank = 124.96 in.
Y-CG = +/- 54.0 in.
Pressurized Radius = 25.61 in.

Weight (lbs)	XCG (in.)	Inertial (Slug-Ft Sq)		Percent Full	Height (in.)	Rigid (lbs)	Slosh (lbs)	H/2R
		I _{yy}	I _{zz}					
1798.2	153.2	0.35		50.0	35.30	1067.4	730.9	0.69
1762.3	153.0	0.29		49.0	34.76	1034.1	728.1	0.68
1726.3	152.9	0.23		48.0	34.23	1000.9	725.4	0.67
1690.3	152.8	0.19		47.0	33.69	967.6	722.7	0.66
1654.4	152.7	0.15		46.0	33.15	934.4	720.0	0.65
1618.4	152.5	0.12		45.0	32.61	901.1	717.3	0.64
1582.4	152.4	0.10		44.0	32.08	867.9	714.6	0.63
1546.5	152.3	0.08		43.0	31.54	834.6	711.9	0.62
1510.5	152.2	0.07		42.0	31.00	801.3	709.2	0.61
1474.5	152.1	0.05		41.0	30.47	768.1	706.4	0.59
1438.6	152.0	0.04		40.0	29.93	734.8	703.7	0.58
1402.6	151.9	0.04		39.0	29.39	701.6	701.0	0.57
1366.6	151.8	0.03		38.0	28.85	668.3	698.3	0.56
1330.7	151.8	0.02		37.0	28.32	635.1	695.6	0.55
1294.7	151.7	0.02		36.0	27.78	601.8	692.9	0.54
1258.8	151.6	0.02		35.0	27.24	568.6	690.2	0.53
1222.8	151.5	0.01		34.0	26.71	535.3	687.5	0.52
1186.8	151.4	0.01		33.0	26.17	502.1	684.8	0.51
1150.9	151.3	0.01		32.0	25.63	468.8	682.0	0.50
1114.9	151.2	0.00		31.0	25.10	444.8	670.1	0.49
1078.9	151.1	0.00		30.0	24.56	420.2	658.7	0.48
1043.0	151.1	0.00		29.0	24.03	395.0	647.9	0.47
1007.0	151.0	0.00		28.0	23.49	369.6	637.4	0.46
971.0	150.9	0.00		27.0	22.95	344.3	626.8	0.45

TABLE 5.1-1 (CONTINUED)
LI-8 DPS FUEL MASS PROPERTIES

Pressure = 235.0 psia
Cylinder Height = 19.28 in.
Density = 56.46 lbs/cu. ft.
Z-CG = 0.0 in.
Pressurized Height = 19.38 in.

Temperature = 70.0°F
Tank Radius = 25.50 in.
Bottom of Tank = 124.96 in.
Y-CG = +/- 54.0 in.
Pressurized Radius = 25.61 in.

Weight (lbs)	XCG (in.)	Inertial (Slug-Ft Sq)		Percent Full	Height (in.)	Rigid (lbs)	Slosh (lbs)	H/2R
		Iyy	Izz					
935.1	150.8	0.00		26.0	22.41	319.4	615.7	0.44
899.1	150.8	0.00		25.0	21.86	295.3	603.9	0.43
863.1	150.8	0.00		24.0	21.32	272.3	590.8	0.42
827.2	150.7	0.00		23.0	20.77	250.9	576.2	0.41
791.2	150.7	0.00		22.0	20.21	231.5	559.7	0.39
755.3	150.6	0.00		21.0	19.65	214.5	540.7	0.38
719.3	150.6	0.00		20.0	19.08	200.5	518.8	0.37
683.3	150.6	0.00		19.0	18.50	184.3	499.0	0.36
647.4	150.6	0.00		18.0	17.92	167.7	479.6	0.35
611.4	150.6	0.00		17.0	17.33	152.1	459.3	0.34
575.4	150.6	0.00		16.0	16.73	137.3	438.1	0.33
539.5	150.6	0.00		15.0	16.11	123.4	416.0	0.31
503.5	150.6	0.00		14.0	15.49	110.4	393.1	0.30
467.5	150.6	0.00		13.0	14.85	98.1	369.4	0.29
431.6	150.6	0.00		12.0	14.19	86.6	345.0	0.28
395.6	150.6	0.00		11.0	13.51	75.8	319.8	0.26
359.6	150.6	0.00		10.0	12.81	65.7	294.0	0.25
323.7	150.6	0.00		9.0	12.09	56.2	267.5	0.24
287.7	150.6	0.00		8.0	11.33	47.3	240.4	0.22
251.8	150.6	0.00		7.0	10.53	38.9	212.9	0.21
215.8	150.6	0.00		6.0	9.69	30.9	184.9	0.19
179.8	150.6	0.00		5.0	8.79	23.1	156.7	0.17
143.9	150.6	0.00		4.0	7.80	15.5	128.4	0.15
107.9	150.6	0.00		3.0	6.71	7.5	100.4	0.13
71.9	150.6	0.00		2.0	5.43	0.0	71.9	0.11
36.0	150.6	0.00		1.0	3.79	0.0	36.0	0.07
0.0	150.6	0.00		0.0	0.00	0.0	0.0	0.00

TABLE 5.1-2
LM-8 DPS OXIDIZER MASS PROPERTIES

Pressure = 235.0 psia
Cylinder Height = 19.28 in.
Density = 90.26 lbs/cu. ft.
Z-CG = +/- 54.0 in.
Pressurized Height = 19.38 in.

Temperature = 70.0°F
Tank Radius = 25.50 in.
Bottom of Tank = 124.96 in.
Y-CG = 0.0 in.
Pressurized Radius = 25.61 in.
Ixx = 0.0

Weight (lbs)	XCG (in.)	Inertial (Slug-Ft Sq)		Percent Full	Height (in.)	Rigid (lbs)	Slosh (lbs)	H/2R
		Iyy	Izz					
5749.4	160.3	0.00		100.0	70.60	5749.4	0.0	1.38
5691.9	159.5	7.05		99.0	66.81	5413.3	278.6	1.30
5634.5	159.2	10.57		98.0	65.18	5246.4	388.0	1.27
5577.0	159.0	13.58		97.0	63.90	5103.5	473.5	1.25
5519.5	158.9	16.30		96.0	62.80	4971.5	548.0	1.23
5462.0	158.8	18.69		95.0	61.81	4845.5	616.4	1.21
5404.5	158.7	20.87		94.0	60.91	4723.2	681.2	1.19
5347.0	158.7	22.87		93.0	60.07	4603.0	743.9	1.17
5289.5	158.6	24.67		92.0	59.27	4484.0	805.5	1.16
5232.0	158.6	26.09		91.0	58.51	4373.1	858.9	1.14
5174.5	158.5	27.07		90.0	57.79	4272.6	901.9	1.19
5117.0	158.5	27.79		89.0	57.09	4175.7	941.3	1.11
5059.5	158.4	28.26		88.0	56.41	4082.0	977.5	1.10
5002.0	158.4	28.49		87.0	55.75	3991.0	1011.0	1.09
4944.5	158.3	28.51		86.0	55.11	3902.3	1042.2	1.08
4887.0	158.3	28.34		85.0	54.49	3815.6	1071.4	1.06
4829.5	158.2	27.97		84.0	53.87	3730.7	1098.8	1.05
4772.0	158.1	27.44		83.0	53.27	3647.4	1124.6	1.04
4714.5	158.0	26.76		82.0	52.68	3565.5	1149.1	1.03
4657.0	158.0	25.94		81.0	52.10	3484.8	1172.2	1.02
4599.6	157.9	24.99		80.0	51.52	3405.2	1194.4	1.01
4542.1	157.7	23.86		79.0	50.95	3333.5	1208.5	0.99
4484.6	157.6	22.56		78.0	50.39	3270.5	1214.1	0.98
4427.1	157.5	21.22		77.0	49.84	3208.0	1219.1	0.97
4369.6	157.3	19.85		76.0	49.28	3146.1	1223.5	0.95

TABLE 5.1-2 (CONTINUED)
LM-8 DPS OXIDIZER MASS PROPERTIES

Pressure = 235.0 psia
Cylinder Height = 19.28 in.
Density = 90.26 lbs/cu. ft.
Z-CG = +/- 54.0 in.
Pressurized Height = 19.38 in.

Temperature = 70.0°F
Tank Radius = 25.50 in.
Bottom of Tank = 124.96 in.
Y-CG = 0.0 in.
Pressurized Radius = 25.61 in.
Ixx = 0.0

Weight (lbs)	XCG (in.)	Inertial (Slug-Ft Sq)	Percent Full	Height (in.)	Rigid (lbs)	Slosh (lbs)	H/2R
		I _{yy} - I _{zz}					
4312.1	157.2	18.45	75.0	48.74	3084.5	1227.5	0.95
4254.6	157.0	17.06	74.0	48.19	3023.5	1231.1	0.94
4197.1	156.8	15.67	73.0	47.65	2962.7	1234.4	0.93
4139.6	156.7	14.29	72.0	47.11	2902.2	1237.3	0.92
4082.1	156.5	12.95	71.0	46.57	2842.0	1240.1	0.91
4024.6	156.3	11.64	70.0	46.04	2781.8	1242.8	0.90
3967.1	156.1	10.38	69.0	45.50	2721.8	1245.3	0.89
3909.6	155.9	9.24	68.0	44.97	2663.2	1246.4	0.88
3852.1	155.7	8.27	67.0	44.43	2610.1	1242.1	0.87
3794.6	155.6	7.37	66.0	43.90	2556.9	1237.7	0.86
3737.1	155.4	6.53	65.0	43.36	2503.7	1233.4	0.85
3679.6	155.3	5.76	64.0	42.82	2450.6	1229.1	0.84
3622.1	155.1	5.05	63.0	42.28	2397.4	1224.7	0.83
3564.7	154.9	4.40	62.0	41.75	2344.3	1220.4	0.82
3507.2	154.8	3.82	61.0	41.21	2291.1	1216.1	0.80
3449.7	154.6	3.30	60.0	40.67	2237.9	1211.7	0.79
3392.2	154.5	2.83	59.0	40.14	2184.8	1207.4	0.78
3334.7	154.3	2.42	58.0	39.60	2131.6	1203.1	0.77
3277.2	154.2	2.05	57.0	39.06	2078.5	1198.7	0.76
3219.7	154.0	1.73	56.0	38.52	2025.3	1194.4	0.75
3162.2	153.9	1.46	55.0	37.99	1972.1	1190.0	0.74
3104.7	153.7	1.22	54.0	37.45	1919.0	1185.7	0.73
3047.2	153.6	1.01	53.0	36.91	1865.8	1181.4	0.72
2989.7	153.4	0.84	52.0	36.37	1812.7	1177.0	0.71
2932.2	153.3	0.69	51.0	35.84	1759.5	1172.7	0.70
2874.7	153.2	0.56	50.0	35.30	1706.3	1168.2	0.69

TABLE 5.1-2 (CONTINUED)
LM-8 DPS OXIDIZER MASS PROPERTIES

Pressure = 235.0 psia
Cylinder Height = 19.28 in.
Density = 90.26 lbs/cu. ft.
Z-CG = +/- 54.0 in.
Pressurized Height = 19.38 in.

Temperature = 70.0°F
Tank Radius = 25.50 in.
Bottom of Tank = 124.96 in.
Y-CG = 0.0 in.
Pressurized Radius = 25.61 in.
Ixx = 0.0

Weight (lbs)	XCG (in.)	Inertial (Slug-Ft Sq)		Percent Full	Height (in.)	Rigid (lbs)	Slosh (lbs)	H/2R
		Iyy	Izz					
2817.2	153.0	0.46		49.0	34.76	1653.2	1164.0	0.68
2759.7	152.9	0.37		48.0	34.23	1600.0	1159.7	0.67
2702.2	152.8	0.30		47.0	33.69	1546.9	1155.4	0.66
2644.7	152.7	0.25		46.0	33.15	1493.7	1151.0	0.65
2587.2	152.5	0.20		45.0	32.61	1440.5	1146.7	0.64
2529.8	152.4	0.16		44.0	32.08	1387.4	1142.4	0.63
2472.3	152.3	0.13		43.0	31.54	1334.2	1138.0	0.62
2414.8	152.2	0.11		42.0	31.00	1281.1	1133.7	0.61
2357.3	152.1	0.09		41.0	30.47	1227.9	1129.4	0.59
2299.8	152.0	0.07		40.0	29.93	1174.8	1125.0	0.58
2242.3	151.9	0.06		39.0	29.39	1121.6	1120.7	0.57
2184.8	151.8	0.05		38.0	28.85	1068.4	1116.4	0.56
2127.3	151.8	0.04		37.0	28.32	1015.3	1112.0	0.55
2069.8	151.7	0.03		36.0	27.78	962.1	1107.7	0.54
2012.3	151.6	0.03		35.0	27.24	909.0	1103.3	0.53
1954.8	151.5	0.02		34.0	26.71	855.8	1099.0	0.52
1897.3	151.4	0.02		33.0	26.17	802.6	1094.7	0.51
1839.8	151.3	0.01		32.0	25.63	749.5	1090.3	0.50
1782.3	151.2	0.01		31.0	25.10	711.1	1071.3	0.49
1724.8	151.1	0.00		30.0	24.56	671.8	1053.1	0.49
1667.3	151.1	0.00		29.0	24.03	631.5	1035.8	0.47
1609.8	151.0	0.00		28.0	23.49	590.9	1019.0	0.46
1552.3	150.9	0.00		27.0	22.95	550.4	1002.0	0.45
1494.9	150.8	0.00		26.0	22.41	510.5	984.3	0.44
1437.4	150.8	0.00		25.0	21.86	472.0	965.3	0.43

Amendment 88
10/5/70

TABLE 5.1-2 (CONTINUED)
LM-8 DPS OXIDIZER MASS PROPERTIES

Pressure = 235.0 psia
Cylinder Height = 19.28 in.
Density = 90.26 lbs/cu. ft.
Z-CG = +/- 54.0 in.
Pressurized Height = 19.38 in.
Temperature = 70.0°F
Tank Radius = 25.50 in.
Bottom of Tank = 124.96 in.
Y-CG = 0.0 in.
Pressurized Radius = 25.61 in.
Ixx = 0.0

Weight (lbs)	XCG (in.)	Inertial (Slug-Ft Sq)		Percent Full	Height (in.)	Rigid (lbs)	Slosh (lbs)	H/2R
		Iyy	Izz					
1379.9	150.8	0.00		24.00	21.32	435.3	944.5	0.42
1322.4	150.7	0.00		23.0	20.77	401.2	921.2	0.41
1264.9	150.7	0.00		22.0	20.21	370.2	894.7	0.39
1207.4	150.6	0.00		21.0	19.65	343.0	864.3	0.38
1149.9	150.6	0.00		20.0	19.08	320.6	829.3	0.37
1092.4	150.6	0.00		19.0	18.50	294.5	797.8	0.36
1034.9	150.6	0.00		18.0	17.92	268.1	766.8	0.35
977.4	150.6	0.00		17.0	17.33	243.1	734.3	0.34
919.9	150.6	0.00		16.0	16.73	219.5	700.4	0.33
862.4	150.6	0.00		15.0	16.11	197.3	665.1	0.31
804.9	150.6	0.00		14.0	15.49	176.4	628.5	0.30
747.4	150.6	0.00		13.0	14.85	156.8	590.6	0.29
689.9	150.6	0.00		12.0	14.19	138.4	551.5	0.28
632.4	150.6	0.00		11.0	13.51	121.2	511.3	0.26
574.9	150.6	0.00		10.0	12.81	105.0	469.9	0.25
517.4	150.6	0.00		9.0	12.09	89.8	427.6	0.24
460.0	150.6	0.00		8.0	11.33	75.6	384.4	0.22
402.5	150.6	0.00		7.0	10.53	62.2	340.3	0.21
345.0	150.6	0.00		6.0	9.69	49.4	295.6	0.19
287.5	150.6	0.00		5.0	8.79	37.0	250.5	0.17
230.0	150.6	0.00		4.0	7.80	24.7	205.2	0.15
172.5	150.6	0.00		3.0	6.71	12.0	160.4	0.13
115.0	150.6	0.00		2.0	5.43	0.0	115.0	0.11
57.5	150.6	0.00		1.0	3.79	0.0	57.5	0.07
0.0	150.6	0.00		0.0	0.00	0.0	0.0	0.00

TABLE 5.1-3
LM 10 AND SUBSEQUENT DPS FUEL MASS PROPERTIES

Amendment 83
7/1/70

Pressure = 235.0 psia - 2 Tanks
Cylinder Height = 22.64 in.
Density = 56.46 lbs/cu. ft.
Y-CG = + OR - 54.0 in. (Const)
Pressurized Height = 22.75 in.

Temperature = 70.0 F
Tank Radius = 25.50 in.
Bottom of Tank = 123.84 in.
Z-CG = 0.0 in. (Const)
Pressurized Radius = 25.61 in.
Ixx = 0.0

<u>Weight (lbs)</u>	<u>XCG (in.)</u>	<u>Inertia (Slug-Ft Sq)</u> <u>Iyy - Izz</u>	<u>Percent Full</u>	<u>Height (in.)</u>	<u>Rigid (lbs)</u>	<u>Slosh (lbs)</u>	<u>H/2R</u>
3822.6	160.8	0.00	100.0	73.96	3822.6	0.0	1.44
3784.3	160.5	6.16	99.0	70.06	3587.6	196.7	1.37
3746.1	160.3	8.81	98.0	68.38	3477.7	268.5	1.33
3707.9	160.2	11.14	97.0	67.05	3380.0	327.8	1.31
3669.7	160.1	13.17	96.0	65.92	3292.6	377.0	1.29
3631.4	160.1	14.97	95.0	64.90	3213.3	418.2	1.27
3593.2	160.0	16.68	94.0	63.95	3140.4	452.8	1.25
3555.0	160.0	17.83	93.0	63.09	3072.3	482.6	1.23
3516.8	159.9	18.67	92.0	62.26	3008.1	508.7	1.22
3478.5	159.8	19.22	91.0	61.48	2946.8	531.7	1.20
3440.3	159.7	19.49	90.0	60.72	2888.1	552.2	1.19
3402.1	159.6	19.51	89.0	60.00	2831.5	570.6	1.17
3363.8	159.4	19.29	88.0	59.29	2776.6	587.2	1.16
3325.6	159.3	18.85	87.0	58.61	2723.3	602.3	1.14
3287.4	159.2	18.21	86.0	57.94	2671.4	616.0	1.13
3249.2	159.0	17.37	85.0	57.29	2620.5	628.7	1.12
3210.9	158.8	16.37	84.0	56.65	2570.7	640.3	1.11
3172.7	158.6	15.24	83.0	56.02	2521.8	651.0	1.09
3134.5	158.5	14.37	82.0	55.40	2473.6	660.9	1.08
3095.3	158.3	13.51	81.0	54.79	2426.1	670.2	1.07
3058.0	158.1	12.68	80.0	54.19	2379.2	678.8	1.06
3019.8	157.9	11.86	79.0	53.59	2332.9	687.0	1.05
2981.6	157.7	11.08	78.0	53.00	2286.9	694.6	1.04
2943.4	157.6	10.32	77.0	52.42	2241.4	701.9	1.02
2905.1	157.4	9.80	76.0	51.84	2196.2	708.9	1.01
2866.9	157.2	8.90	75.0	51.26	2151.3	715.6	1.00
2828.7	157.0	8.24	74.0	50.69	2106.7	722.0	0.99
2790.5	156.8	7.60	73.0	50.11	2063.8	726.7	0.98
2752.2	156.6	6.99	72.0	49.55	2021.2	731.0	0.97
2714.0	156.4	6.41	71.0	48.98	1979.0	735.0	0.96
2675.8	156.3	5.86	70.0	48.41	1937.0	738.8	0.95

TABLE 5.1-3

LM 10 AND SUBSEQUENT DPS FUEL MASS PROPERTIES (CONTINUED)

Amendment 83
7/1/70

Pressure = 235.0 psia - 2 Tanks
 Cylinder Height = 22.64 in.
 Density = 56.46 lbs/cu. ft.
 Y-CG = + OR - 54.0 in. (Const)
 Pressurized Height = 22.75 in.

Temperature = 70.0 F
 Tank Radius = 25.50 in.
 Bottom of Tank = 123.84 in.
 Z-CG = 0.0 IN. (CONST)
 Pressurized Radius = 25.61 in.
 Ixx = 0.0

Weight (lbs)	XCG (in.)	Inertia (Slug-Ft Sq)		Percent Full	Height (in.)	Rigid (lbs)	Slosh (lbs)	H/2R
		Iyy	Izz					
2637.6	156.1	5.33		69.0	47.84	1895.2	742.4	0.93
2599.3	155.9	4.83		58.0	47.27	1853.5	745.8	0.92
2561.1	155.7	4.37		67.0	46.70	1812.2	748.9	0.91
2522.9	155.5	3.95		66.0	46.12	1771.1	751.8	0.90
2484.7	155.3	3.55		65.0	45.55	1730.3	754.4	0.89
2446.4	155.1	3.18		64.0	44.98	1689.7	756.7	0.88
2408.2	154.9	2.85		63.0	44.41	1649.5	758.7	0.87
2370.0	154.7	2.54		62.0	43.84	1609.5	760.5	0.86
2331.8	154.5	2.26		61.0	43.27	1569.8	762.0	0.84
2293.5	154.3	2.00		60.0	42.70	1530.4	763.1	0.83
2255.3	154.1	1.77		59.0	42.13	1491.3	764.0	0.82
2217.1	153.9	1.56		58.0	41.56	1452.5	764.8	0.81
2178.9	153.7	1.37		57.0	40.99	1414.0	764.9	0.80
2140.6	153.6	1.20		56.0	40.42	1375.8	764.8	0.79
2102.4	153.4	1.05		55.0	39.84	1337.9	764.5	0.78
2064.2	153.2	0.91		54.0	39.27	1300.3	763.9	0.77
2026.0	153.0	0.79		53.0	38.70	1263.0	762.9	0.76
1987.7	152.9	0.69		52.0	38.13	1226.1	761.7	0.74
1949.5	152.7	0.60		51.0	37.56	1189.4	760.1	0.73
1911.3	152.5	0.52		50.0	36.99	1153.1	758.2	0.72
1873.1	152.4	0.45		49.0	36.42	1117.1	756.0	0.71
1834.8	152.2	0.39		48.0	35.85	1081.4	753.4	0.70
1796.6	152.1	0.33		47.0	35.28	1046.0	750.6	0.69
1758.4	151.9	0.29		46.0	34.71	1011.0	747.3	0.68
1720.2	151.8	0.25		45.0	34.13	976.3	743.8	0.67
1681.9	151.6	0.21		44.0	33.56	942.0	739.9	0.66
1643.7	151.5	0.18		43.0	32.99	908.0	735.7	0.64
1605.5	151.4	0.16		42.0	32.42	874.3	731.1	0.63
1567.2	151.3	0.13		41.0	31.85	841.0	726.2	0.62
1529.0	151.1	0.11		40.0	31.28	808.1	720.9	0.61
1490.8	151.0	0.10		39.0	30.71	775.5	715.3	0.60
1452.6	150.9	0.08		38.0	30.14	743.2	709.3	0.59

TABLE 5.1-3
LM 10 AND SUBSEQUENT DPS FUEL MASS PROPERTIES (CONTINUED)

Amendment 83
7/1/70

Pressure = 235.0 psia - 2 Tanks
Cylinder Height = 22.64 in.
Density = 56.46 lbs/cu. ft.
Y-CG = + OR - 54.0 in. (Const)
Pressurized Height = 22.75 in.

Temperature = 70.0 F
Tank Radius = 25.50 in.
Bottom of Tank = 123.84 in.
Z-CG = 0.0 in. (Const)
Pressurized Radius = 25.61 in.
Ixx = 0.0

Weight (lbs)	XCG (in.)	Inertia (Slug-Ft Sq)		Percent Full	Height (in.)	Rigid (lbs)	Slosh (lbs)	H/2R
		Iyy	Izz					
1414.3	150.8	0.07		37.0	29.57	711.3	703.0	0.58
1376.1	150.7	0.06		36.0	29.00	679.8	696.3	0.57
1337.9	150.6	0.05		35.0	28.42	648.7	689.2	0.55
1299.7	150.5	0.04		34.0	27.85	617.9	681.8	0.54
1261.4	150.4	0.04		33.0	27.28	587.4	674.0	0.53
1223.2	150.4	0.03		32.0	26.71	557.4	665.8	0.52
1185.0	150.3	0.03		31.0	26.14	527.7	657.3	0.51
1146.8	150.2	0.02		30.0	25.57	498.8	648.0	0.50
1108.5	150.1	0.02		29.0	25.00	471.2	637.3	0.49
1070.3	150.0	0.02		28.0	24.43	444.3	626.0	0.48
1032.1	150.0	0.01		27.0	23.86	417.9	614.2	0.47
993.9	149.9	0.01		26.0	23.29	392.1	601.7	0.45
955.6	149.8	0.01		25.0	22.72	366.9	588.7	0.44
917.4	149.8	0.01		24.0	22.14	342.3	575.2	0.43
879.2	149.7	0.01		23.0	21.56	318.2	561.0	0.42
841.0	149.7	0.00		22.0	20.98	294.6	546.4	0.41
802.7	149.6	0.00		21.0	20.39	271.6	531.1	0.40
764.5	149.6	0.00		20.0	19.79	249.2	515.3	0.39
726.3	149.5	0.00		19.0	19.19	227.3	499.0	0.37
688.1	149.5	0.00		18.0	18.58	206.1	482.0	0.36
649.8	149.5	0.00		17.0	17.98	185.4	464.5	0.35
611.6	149.5	0.00		16.0	17.33	165.3	446.3	0.34
573.4	149.5	0.00		15.0	16.69	145.9	427.5	0.33
535.2	149.5	0.00		14.0	16.04	127.1	408.1	0.31
496.9	149.5	0.00		13.0	15.37	109.0	387.9	0.30
458.7	149.5	0.00		12.0	14.69	91.7	367.0	0.29
420.5	149.5	0.00		11.0	13.98	75.2	345.3	0.27
382.3	149.5	0.00		10.0	13.26	59.5	322.8	0.26
344.0	149.5	0.00		9.0	12.50	44.8	299.2	0.24
305.8	149.5	0.00		8.0	11.72	31.1	274.7	0.23
267.6	149.5	0.00		7.0	10.89	18.7	248.9	0.21
229.4	149.5	0.00		6.0	10.02	7.7	221.6	0.20

TABLE 5.1-3
LM 10 AND SUBSEQUENT DPS FUEL MASS PROPERTIES (CONCLUDED)

Amendment 83
7/1/70

Pressure = 235.0 psia - 2 Tanks
Cylinder Height = 22.64 in.
Density = 56.46 lbs/cu. ft.
Y-CG = + OR - 54.0 in. (Const)
Pressurized Height = 22.75 in.

Temperature = 70.0 F
Tank Radius = 25.50 in.
Bottom of Tank = 123.84 in.
Z-CG = 0.0 in. (Const)
Pressurized Radius = 25.61 in.
Ixx = 0.0

<u>Weight (lbs)</u>	<u>XCG (in.)</u>	<u>Inertia (Slug-Ft Sq)</u> <u>Iyy - Izz</u>	<u>Percent Full</u>	<u>Height (in.)</u>	<u>Rigid (lbs)</u>	<u>Slosh (lbs)</u>	<u>H/2R</u>
191.1	149.5	0.00	5.0	9.08	0.0	191.1	0.18
152.9	149.5	0.00	4.0	8.06	0.0	152.9	0.16
114.7	149.5	0.00	3.0	6.92	0.0	114.7	0.14
76.5	149.5	0.00	2.0	5.60	0.0	76.5	0.11
38.2	149.5	0.00	1.0	3.91	0.0	38.2	0.08
0.0	149.5	0.00	0.0	0.00	0.0	0.0	0.00

TABLE 5.1-4

Amendment 83
7/1/70

LM 10 AND SUBSEQUENT DPS OXIDIZER MASS PROPERTIES

Pressure = 235.0 psia - 2 Tanks
 Cylinder Height = 22.64 in.
 Density = 90.26 lbs/cu. ft.
 Y-CG = 0.0 in. (Const)
 Pressurized Height = 22.75 in.

Temperature = 70.0 F
 Tank Radius = 25.50 in.
 Bottom of Tank = 123.84 in.
 Z-CG = + OR - 54.0 in. (Const)
 Pressurized Radius = 25.61 in.
 Ixx = 0.0

Weight (lbs)	XCG (in.)	Inertia (Slug-Ft Sq)		Percent Full	Height (in.)	Rigid (lbs)	Slosh (lbs)	H/2R
		I _{yy}	I _{zz}					
6110.9	160.8	0.00		100.0	73.96	6110.9	0.0	1.44
6049.8	160.5	9.84		99.0	70.06	5735.3	314.5	1.37
5988.7	160.3	14.09		98.0	68.38	5559.5	429.2	1.33
5927.6	160.2	17.80		97.0	67.05	5403.5	524.1	1.31
5866.5	160.1	21.06		96.0	65.92	5263.7	602.8	1.29
5805.4	160.1	23.93		95.0	64.90	5136.9	668.5	1.27
5744.3	160.0	26.67		94.0	63.98	5020.4	723.9	1.25
5683.2	160.0	28.51		93.0	63.09	4911.6	771.6	1.23
5622.0	159.9	29.85		92.0	62.26	4808.8	813.2	1.22
5560.9	159.8	30.72		91.0	61.48	4711.0	850.0	1.20
5499.8	159.7	31.16		90.0	60.72	4617.1	882.8	1.19
5438.7	159.6	31.19		89.0	60.00	4526.6	912.2	1.17
5377.6	159.4	30.84		88.0	59.29	4438.9	938.7	1.16
5316.6	159.3	30.14		87.0	58.61	4353.7	962.8	1.14
5255.4	159.2	29.10		86.0	57.94	4270.6	984.8	1.13
5194.3	159.0	27.77		85.0	57.29	4189.3	1005.0	1.12
5133.2	158.8	26.18		84.0	56.65	4109.6	1023.5	1.11
5072.1	158.6	24.37		83.0	56.02	4031.4	1040.7	1.09
5011.0	158.5	22.97		82.0	55.40	3954.4	1056.6	1.08
4949.8	158.3	21.60		81.0	54.79	3878.5	1071.4	1.07
4888.7	158.1	20.26		80.0	54.19	3803.5	1085.2	1.06
4827.6	157.9	18.97		79.0	53.59	3729.4	1098.2	1.05
4766.5	157.7	17.71		78.0	53.00	3656.0	1110.5	1.03
4705.4	157.6	16.51		77.0	52.42	3583.3	1122.2	1.02
4644.3	157.4	15.35		76.0	51.84	3511.0	1133.3	1.01
4583.2	157.2	14.23		75.0	51.26	3439.2	1143.9	1.00
4522.1	157.0	13.17		74.0	50.69	3367.9	1154.2	0.99
4461.0	156.8	12.14		73.0	50.11	3299.2	1161.7	0.98
4399.9	156.6	11.17		72.0	49.55	3231.2	1168.7	0.97
4338.8	156.4	10.24		71.0	48.98	3163.7	1175.1	0.96
4277.6	156.3	9.37		70.0	48.41	3096.6	1181.0	0.95

TABLE 5.1-4

LM 10 AND SUBSEQUENT DPS OXIDIZER MASS PROPERTIES (CONTINUED)

Amendment 83
7/1/70

Pressure = 235.0 psia - 2 Tanks
 Cylinder Height = 22.64 in.
 Density = 90.26 lbs/cu. ft.
 Y-CG = 0.0 in.(Const)
 Pressurized Height = 22.75 in.

Temperature = 70.0 F
 Tank Radius = 25.50 in.
 Bottom of Tank = 123.84 in.
 Z-CG = + OR - 54.0 in.(Const)
 Pressurized Radius = 25.61 in.
 Ixx = 0.0

Weight (lbs)	XCG (in.)	Inertia (Slug-Ft Sq)		Percent Full	Height (in.)	Rigid (lbs)	Slosh (lbs)	H/2R
		Iyy	Izz					
4216.5	156.1	8.52		69.0	47.84	3029.7	1186.8	0.93
4155.4	155.9	7.73		68.0	47.27	2963.1	1192.3	0.92
4094.3	155.7	6.99		67.0	46.70	2897.0	1197.3	0.91
4033.2	155.5	6.31		66.0	46.12	2831.3	1201.9	0.90
3972.1	155.3	5.67		65.0	45.55	2766.1	1206.0	0.89
3911.0	155.1	5.09		64.0	44.98	2701.3	1209.7	0.88
3849.9	154.9	4.55		63.0	44.41	2636.9	1213.0	0.87
3788.8	154.7	4.06		62.0	43.84	2573.0	1215.8	0.86
3727.7	154.5	3.61		61.0	43.27	2509.6	1218.1	0.84
3666.6	154.3	3.20		60.0	42.70	2446.6	1220.0	0.83
3605.4	154.1	2.83		59.0	42.13	2384.1	1221.4	0.82
3544.3	153.9	2.49		58.0	41.56	2322.0	1222.3	0.81
3483.2	153.7	2.19		57.0	40.99	2260.5	1222.7	0.80
3422.1	153.6	1.91		56.0	40.42	2199.4	1222.7	0.79
3361.0	153.4	1.67		55.0	39.84	2138.8	1222.2	0.78
3299.9	153.2	1.46		54.0	39.27	2078.7	1221.2	0.77
3238.8	153.0	1.27		53.0	38.70	2019.1	1219.7	0.76
3177.7	152.9	1.10		52.0	38.13	1960.0	1217.7	0.74
3116.6	152.7	0.96		51.0	37.56	1901.4	1215.1	0.73
3055.5	152.5	0.83		50.0	36.99	1843.4	1212.1	0.72
2994.4	152.4	0.72		49.0	36.42	1785.8	1208.5	0.71
2933.2	152.2	0.62		48.0	35.85	1728.8	1204.5	0.70
2872.1	152.1	0.54		47.0	35.28	1672.3	1199.9	0.69
2811.0	151.9	0.46		46.0	34.71	1616.3	1194.7	0.68
2749.9	151.8	0.40		45.0	34.13	1560.8	1189.1	0.67
2688.8	151.6	0.34		44.0	33.56	1505.9	1182.9	0.66
2627.7	151.5	0.29		43.0	32.99	1451.6	1176.1	0.64
2566.6	151.4	0.25		42.0	32.42	1397.8	1168.8	0.63
2505.5	151.3	0.21		41.0	31.65	1344.5	1161.0	0.62
2444.4	151.1	0.18		40.0	31.28	1291.8	1152.5	0.61
2383.3	151.0	0.16		39.0	30.71	1239.7	1143.5	0.60
2322.2	150.9	0.13		38.0	30.14	1188.2	1134.0	0.59

TABLE 5.1-4
LM 10 AND SUBSEQUENT DPS OXIDIZER MASS PROPERTIES (CONTINUED)

Amendment 83
7/1/70

Pressure = 235.0 psia - 2 Tanks
Cylinder Height = 22.64 in.
Density = 90.26 lbs/cu. ft.
Y-CG = 0.0 in. (Const)
Pressurized Height = 22.75 in.

Temperature = 70.0 F
Tank Radius = 25.50 in.
Bottom of Tank = 123.84 in.
Z-CG = + OR - 54.0 in. (Const)
Pressurized Radius = 25.61 in.
Ixx = 0.0

<u>Weight (lbs)</u>	<u>XCG (in.)</u>	<u>Inertia (Slug-Ft Sq)</u> <u>Iyy - Izz</u>	<u>Percent Full</u>	<u>Height (in.)</u>	<u>Rigid (lbs)</u>	<u>Slosh (lbs)</u>	<u>H/2R</u>
2261.0	150.8	0.11	37.0	29.57	1137.2	1123.9	0.58
2199.9	150.7	0.10	36.0	29.00	1086.8	1113.1	0.57
2138.8	150.6	0.08	35.0	28.42	1037.0	1101.9	0.55
2077.7	150.5	0.07	34.0	27.85	987.7	1090.0	0.54
2016.6	150.4	0.08	33.0	27.28	939.1	1077.5	0.53
1955.5	150.4	0.05	32.0	26.71	891.1	1064.4	0.52
1894.4	150.3	0.04	31.0	26.14	843.7	1050.7	0.51
1833.3	150.2	0.04	30.0	25.57	797.3	1035.9	0.50
1772.2	150.1	0.03	29.0	25.00	753.3	1018.8	0.49
1711.1	150.0	0.03	28.0	24.43	710.3	1000.8	0.48
1649.9	150.0	0.02	27.0	23.85	668.1	981.8	0.47
1588.8	149.9	0.02	26.0	23.29	626.9	961.9	0.45
1527.7	149.8	0.02	25.0	22.72	586.6	941.2	0.44
1466.6	149.8	0.01	24.0	22.14	547.1	919.5	0.43
1405.5	149.7	0.01	23.0	21.55	508.6	896.9	0.42
1344.4	149.7	0.01	22.0	20.98	471.0	873.4	0.41
1283.3	149.6	0.00	21.0	20.39	434.2	849.1	0.40
1222.2	149.6	0.00	20.0	19.79	398.4	823.8	0.39
1161.1	149.5	0.00	19.0	19.19	363.4	797.7	0.37
1100.0	149.5	0.00	18.0	18.58	329.4	770.6	0.36
1038.9	149.5	0.00	17.0	17.96	296.4	742.5	0.35
977.7	149.5	0.00	16.0	17.33	264.3	713.5	0.34
916.6	149.5	0.00	15.0	16.69	233.2	683.4	0.33
855.5	149.5	0.00	14.0	16.04	203.2	652.3	0.31
794.4	149.5	0.00	13.0	15.37	174.3	620.1	0.30
733.3	149.5	0.00	12.0	14.69	146.6	586.7	0.29
672.2	149.5	0.00	11.0	13.96	120.2	552.0	0.27
611.1	149.5	0.00	10.0	13.26	95.1	516.0	0.26
550.0	149.5	0.00	9.0	12.50	71.6	478.4	0.24

TABLE 5.1-4
LM 10 AND SUBSEQUENT DPS OXIDIZER MASS PROPERTIES (CONCLUDED)

Amendment 83
7/1/70

Pressure = 235.0 psia - 2 Tanks
Cylinder Height = 22.64 in.
Density = 90.26 lbs/cu. ft.
Y-CG = 0.0 in. (Const)
Pressurized Height = 22.75 in.

Temperature = 70.0 F
Tank Radius = 25.50 in.
Bottom of Tank = 123.84 in.
Z-CG = + OR - 54.0 in. (Const)
Pressurized Radius = 25.61 in.
Ixx = 0.0

<u>Weight (lbs)</u>	<u>XCG (in.)</u>	<u>Inertia (Slug-Ft Sq)</u>		<u>Percent Full</u>	<u>Height (in.)</u>	<u>Rigid (lbs)</u>	<u>Slosh (lbs)</u>	<u>H/2R</u>
		<u>Iyy</u>	<u>Izz</u>					
488.9	149.5	0.00	0.00	8.0	11.72	49.8	439.1	0.23
427.8	149.5	0.00	0.00	7.0	10.89	29.9	397.9	0.21
366.7	149.5	0.00	0.00	6.0	10.02	12.3	354.3	0.20
305.5	149.5	0.00	0.00	5.0	9.08	0.0	305.5	0.18
244.4	149.5	0.00	0.00	4.0	8.06	0.0	244.4	0.16
183.3	149.5	0.00	0.00	3.0	6.92	0.0	183.3	0.14
122.2	145.5	0.00	0.00	2.0	5.60	0.0	122.2	0.11
61.1	149.5	0.00	0.00	1.0	3.91	0.0	61.1	0.08
0.0	149.5	0.00	0.00	0.0	0.00	0.0	0.0	0.00

TABLE 5.2-1

APS TANKED FUEL MASS PROPERTIES

The following mass properties are to be used over the entire range of tanked fuel quantity:

X_{cg}	-	228.0 inches
Y_{cg}	-	-71.3 inches
Z_{cg}	-	0.0 inches
I_{xx}	-	0 slug-feet ²
I_{yy}	-	0 slug-feet ²
I_{zz}	-	0 slug-feet ²
I_{xy}	-	0 slug-feet ²
I_{xz}	-	0 slug-feet ²
I_{yz}	-	0 slug-feet ²

U U

LM ASCENT FUEL MASS PROPERTIES-70°F-1 TANK

Y-CG = -71.3 (CONST) Z-CG = 0.0 (CONST)

RADIUS= 24.700 CYLINDRICAL SECTION= -0.0 WEIGHT= 1995.6

DENSITY= 56.330 LBS/CU.FT.

WEIGHT	X-CG	IXX(S-FT.SQ)	IYY or IZZ(S-FT.SQ)
1566.5	223.4	4.4	3.3
1556.6	223.3	4.3	3.3
1546.6	223.3	3.3	3.2
1536.6	223.2	3.3	3.2
1526.6	223.1	4.2	3.2
1516.7	223.0	4.2	3.1
1506.7	222.9	4.2	3.1
1496.7	222.8	4.2	3.1
1486.7	222.7	4.1	3.0
1476.7	222.7	4.1	3.0
1466.8	222.6	4.1	3.0
1456.8	222.5	4.0	2.9
1446.8	222.4	4.0	2.9
1436.8	222.3	4.0	2.9
1426.9	222.2	3.9	2.8
1416.9	222.1	3.9	2.8
1406.9	222.0	3.9	2.8
1396.9	222.0	3.8	2.8
1386.9	221.9	3.8	2.7
1377.0	221.8	3.8	2.7
1367.0	221.7	3.8	2.7
1357.0	221.6	3.7	2.6
1347.0	221.5	3.7	2.6
1337.1	221.4	3.7	2.6
1327.1	221.4	3.6	2.5
1317.1	221.3	3.6	2.5
1307.1	221.2	3.6	2.5
1297.1	221.1	3.5	2.5
1287.2	221.0	3.5	2.4
1277.2	220.9	3.5	2.4
1267.2	220.8	3.4	2.4
1257.2	220.8	3.4	2.3
1247.2	220.7	3.4	2.3
1237.3	220.6	3.3	2.3
1227.3	220.5	3.3	2.2
1217.3	220.4	3.3	2.2
1207.3	220.3	3.2	2.2
1197.4	220.2	3.2	2.2
1187.4	220.1	3.2	2.1
1177.4	220.1	3.0	2.1
1167.4	220.0	3.1	2.1
1157.4	219.9	3.1	2.1
1147.5	219.8	3.0	2.0

LM ASCENT FUEL MASS PROPERTIES-70°F-1 TANK

Y-CG = -71.3 (CONST) Z-CG = 0.0 (CONST)

RADIUS= 24.700 CYLINDRICAL SECTION= -0.0 WEIGHT= 1995.6
 DENSITY= 56.330 LBS/CU.FT.

WEIGHT	X-CG	IXX(S-FT.SQ)	LYY or IZZ(S-FT.SQ)
1137.5	219.7	3.0	2.0
1127.5	219.6	3.0	2.0
1117.5	219.5	3.0	1.9
1107.6	219.4	2.9	1.9
1097.6	219.4	2.9	1.9
1087.6	219.3	2.9	1.9
1077.6	219.2	2.8	1.8
1067.6	219.1	2.8	1.8
1057.7	219.0	2.8	1.8
1047.7	218.9	2.7	1.8
1037.7	218.8	2.7	1.7
1027.7	218.7	2.7	1.7
1017.8	218.6	2.6	1.7
1007.8	218.5	2.6	1.7
997.8	218.5	2.6	1.6
987.8	218.4	2.5	1.6
977.8	218.3	2.5	1.6
967.9	218.2	2.5	1.6
957.9	218.1	2.4	1.5
947.9	218.0	2.4	1.5
937.9	217.9	2.4	1.5
928.0	217.8	2.3	1.5
918.0	217.7	2.3	1.4
908.0	217.6	2.3	1.4
898.0	217.5	2.2	1.4
888.0	217.4	2.2	1.4
878.1	217.4	2.2	1.3
868.1	217.3	2.1	1.3
858.1	217.2	2.1	1.3
848.1	217.1	2.1	1.3
838.2	217.0	2.0	1.2
828.2	216.9	2.0	1.2
818.2	216.8	2.0	1.2
808.2	216.7	1.9	1.2
798.2	216.6	1.9	1.2
788.3	216.5	1.9	1.1
778.3	216.4	1.8	1.1
768.3	216.3	1.8	1.1
758.3	216.2	1.8	1.1
748.3	216.1	1.7	1.0
738.4	216.0	1.7	1.0
728.4	215.9	1.7	1.0
718.4	215.8	1.7	1.0

U U

LM ASCENT FUEL MASS PROPERTIES-70°F-1 TANK
Y-CG = -71.3 (CONST) Z-CG = 0.0 (CONST)

RADIUS= 24.700 CYLINDRICAL SECTION= -0.0 WEIGHT= 1995.6
DENSITY= 56.330 LBS/CU.FT.

WEIGHT	X-CG	IXX(S-FT.SQ)	IYY or OZZ(S-FT.SQ)
279.4	210.7	0.4	0.2
269.4	210.6	0.4	0.2
259.4	210.5	0.4	0.2
249.4	210.3	0.3	0.2
239.5	210.2	0.3	0.2
229.5	210.0	0.3	0.1
219.5	209.8	0.3	0.1
209.5	209.7	0.3	0.1
199.6	209.5	0.2	0.1
189.6	209.4	0.2	0.1
179.6	209.2	0.2	0.1
169.6	209.0	0.2	0.1
159.6	208.8	0.2	0.1
149.7	208.7	0.1	0.0
139.7	208.5	0.1	0.0
129.7	208.3	0.1	0.0
119.7	208.1	0.1	0.0
109.8	207.9	0.1	0.0
99.8	207.6	0.1	0.0
89.8	207.4	0.0	0.0
79.8	207.2	0.0	0.0
69.8	206.9	0.0	0.0
59.9	206.6	0.0	0.0
49.9	206.3	0.0	0.0
39.9	206.0	0.0	0.0
29.9	205.6	0.0	0.0
20.0	205.2	0.0	0.0
10.0	204.6	0.0	0.0

U U U U E E E E E E E E U U U U U U U U

LM ASCENT OXIDIZER MASS PROPERTIES-70°F-1 TANK

Y-CG = +44.5 (CONST) Z-CG = 0.0 (CONST)

RADIUS= 24.700 CYLINDRICAL SECTION= -0.0 WEIGHT= 3172.9

DENSITY= 90.050 LBS/CU.FT.

(ULLAGE/VOL.OF LIQUID))x100= 3.672

WEIGHT	X-CG	IXX(S-FT.SQ)	IYY or IZZ(S-FT.SQ)
3172.9	227.2	8.5	8.0
3157.0	227.1	8.5	7.9
3141.2	227.0	8.5	7.8
3125.3	226.9	8.4	7.8
3109.4	226.8	8.4	7.7
3093.6	226.7	8.4	7.6
3077.7	226.6	8.4	7.5
3061.8	226.6	8.3	7.5
3046.0	226.5	8.3	7.4
3030.1	226.4	8.3	7.3
3014.3	226.3	8.2	7.3
2998.4	226.2	8.2	7.2
2982.6	226.1	8.2	7.1
2966.7	226.0	8.2	7.1
2950.8	225.9	8.1	7.0
2934.9	225.8	8.1	6.9
2919.1	225.7	8.1	6.9
2903.2	225.6	8.0	6.8
2887.3	225.5	8.0	6.7
2871.5	225.5	7.9	6.7
2855.6	225.4	7.9	6.6
2839.7	225.3	7.9	6.5
2823.9	225.2	7.8	6.5
2808.0	225.1	7.8	6.4
2792.2	225.0	7.8	6.4
2776.3	224.9	7.7	6.3
2760.4	224.8	7.7	6.2
2744.6	224.7	7.6	6.2
2728.7	224.7	7.6	6.1
2712.8	224.6	7.6	6.1
2697.0	224.5	7.5	6.0
2681.1	224.4	7.5	5.9
2665.2	224.3	7.4	5.9
2649.4	224.2	7.4	5.8
2633.5	224.1	7.3	5.8
2617.6	224.0	7.3	5.7
2601.8	224.0	7.3	5.7
2589.9	223.9	7.2	5.6
2570.0	223.8	7.2	5.5
2554.2	223.7	7.1	5.5
2538.3	223.6	7.1	5.4
2522.5	223.5	7.0	5.4
2506.6	223.4	7.6	5.3



LM ASCENT OXIDIZER MASS PROPERTIES-70°F-1 TANK
 Y-CG = +44.5 (CONST) Z-CG = 0.0 (CONST)

RADIUS= 24.700 CYLINDRICAL SECTION= -0.0 WEIGHT= 3172.9
 DENSITY= 90.050 LBS/CU.FT.

WEIGHT	X-CG	IXX(S-FT.SQ)	IYY or IZZ(S-FT.SQ)
2490.7	223.4	7.0	5.3
2474.9	223.3	6.9	5.2
2459.0	223.2	6.9	5.2
2443.1	223.1	6.8	5.1
2427.3	223.0	6.8	5.1
2411.4	222.9	6.7	5.0
2395.5	222.8	6.7	5.0
2379.7	222.8	6.6	4.9
2363.8	222.7	6.6	4.9
2347.9	222.6	6.5	4.8
2332.1	222.5	6.5	4.7
2316.2	222.4	6.4	4.7
2300.4	222.3	6.4	4.6
2284.5	222.2	6.3	4.6
2268.6	222.2	6.3	4.5
2252.8	222.1	6.2	4.5
2236.9	222.0	6.2	4.4
2221.0	221.9	6.1	4.4
2205.2	221.8	6.1	4.3
2189.3	221.7	6.0	4.3
2173.4	221.6	6.0	4.3
2157.6	221.6	5.9	4.2
2141.7	221.5	5.9	4.2
2125.8	221.4	5.8	4.1
2110.0	221.3	5.8	4.1
2094.1	221.2	5.7	4.0
2078.2	221.1	5.7	4.0
2062.4	221.0	5.6	3.9
2046.5	221.0	5.6	3.9
2030.7	220.9	5.5	3.8
2014.8	220.8	5.5	3.8
1998.9	220.7	5.4	3.7
1983.1	220.6	5.4	3.7
1967.2	220.5	5.3	3.6
1951.3	220.4	5.3	3.6
1935.5	220.3	5.2	3.6
1919.6	220.3	5.2	3.5
1903.7	220.2	5.1	3.5
1887.9	220.1	5.1	3.4
1872.0	220.0	5.0	3.4
1856.1	219.9	5.0	3.3
1840.3	219.8	4.9	3.3
1824.4	219.7	4.9	3.2

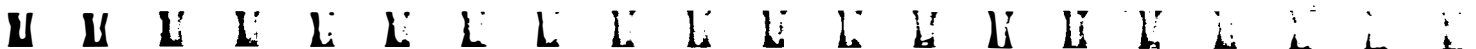

LM ASCENT OXIDIZER MASS PROPERTIES-70°F-1 TANK
 Y-CG = +44.5 (CONST) Z-CG = 0.0 (CONST)

RADIUS= 24.700 CYLINDRICAL SECTION= -0.0 WEIGHT= 3172.9
 DENSITY= 90.050 LBS/CU.FT.

WEIGHT	X-CG	IXX(S-FT.SQ)	IYY or IZZ(S-FT.SQ)
1808.6	219.7	4.8	3.2
1792.7	219.6	4.8	3.2
1776.8	219.5	4.7	3.1
1761.0	219.4	4.7	3.1
1745.1	219.3	4.6	3.0
1729.2	219.2	4.6	3.0
1713.4	219.1	4.5	2.9
1697.5	219.0	4.5	2.9
1681.6	218.9	4.4	2.9
1665.8	218.9	4.4	2.8
1649.9	218.8	4.3	2.8
1634.0	218.7	4.2	2.7
1618.2	218.6	4.2	2.7
1602.3	218.5	4.1	2.7
1586.4	218.4	4.1	2.6
1570.6	218.3	4.0	2.6
1554.7	218.2	4.0	2.5
1538.9	218.1	3.9	2.5
1523.0	218.0	3.9	2.5
1507.1	218.0	3.8	2.4
1491.3	217.9	3.8	2.4
1475.4	217.8	3.7	2.3
1459.5	217.7	3.7	2.3
1443.7	217.6	3.6	2.3
1427.8	217.5	3.6	2.2
1411.9	217.4	3.5	2.2
1396.1	217.3	3.5	2.1
1380.2	217.2	3.4	2.1
1364.3	217.1	3.4	2.1
1348.5	217.0	3.3	2.0
1332.6	216.9	3.3	2.0
1316.8	216.8	3.2	2.0
1300.9	216.7	3.2	1.9
1285.0	216.7	3.1	1.9
1269.2	216.6	3.1	1.9
1253.3	216.5	3.0	1.8
1237.4	216.4	3.0	1.8
1221.6	216.3	2.9	1.7
1205.7	216.2	2.9	1.7
1189.8	216.1	2.8	1.7
1174.0	216.0	2.8	1.6
1158.1	215.9	2.7	1.6
1142.2	215.8	2.7	1.6



LM ASCENT OXIDIZER MASS PROPERTIES-70°F-1 TANK

Y-CG = +44.5 (CONST) Z-CG = 0.0 (CONST)

RADIUS= 24.700 CYLINDRICAL SECTION= -0.0 WEIGHT= 3172.9

DENSITY= 90.050 LBS/CU.FT.

WEIGHT	X-CG	IXX(S-FT.SQ)	IYY or IZZ(S-FT.SQ)
1126.4	215.7	2.6	1.5
1110.5	215.6	2.6	1.5
1094.7	215.5	2.5	1.5
1078.8	215.4	2.5	1.4
1062.9	215.3	2.4	1.4
1047.1	215.2	2.4	1.4
1031.2	215.1	2.3	1.3
1015.3	215.0	2.3	1.3
999.5	214.9	2.2	1.3
983.6	214.8	2.2	1.3
967.7	214.7	2.1	1.2
951.9	214.6	2.1	1.2
936.0	214.4	2.0	1.2
920.1	214.3	2.0	1.1
904.3	214.2	1.9	1.1
888.4	214.1	1.9	1.1
872.5	214.0	1.8	1.0
856.7	213.9	1.8	1.0
840.8	213.8	1.7	1.0
825.0	213.7	1.7	1.0
809.1	213.6	1.6	0.9
793.2	213.5	1.6	0.9
777.4	213.4	1.6	0.9
761.5	213.2	1.5	0.8
745.6	213.1	1.5	0.8
729.8	213.0	1.4	0.8
713.9	212.9	1.4	0.8
698.0	212.8	1.3	0.7
682.2	212.7	1.3	0.7
666.3	212.5	1.2	0.7
650.4	212.4	1.2	0.7
634.6	212.3	1.2	0.6
618.7	212.2	1.1	0.6
602.9	212.1	1.1	0.6
587.0	211.9	1.0	0.6
571.1	211.8	1.0	0.5
555.3	211.7	1.0	0.5
539.4	211.5	0.9	0.5
523.5	211.4	0.9	0.5
507.7	211.3	0.8	0.4
491.8	211.1	0.8	0.4
475.9	211.0	0.8	0.4
460.1	210.9	0.7	0.4

U U U U U U U U U U U U U U U U U U U U

LM ASCENT OXIDIZER MASS PROPERTIES-70°F-1 TANK
Y-CG = +44.5 (CONST) Z-CG = 0.0 (CONST)

RADIUS= 24.700 CYLINDRICAL SECTION= -0.0 WEIGHT= 3172.9
DENSITY= 90.050 LBS/CU.FT.

WEIGHT	X-CG	IXX(S-FT.SQ)	IYY or IZZ(S-FT.SQ)
444.2	210.7	0.7	0.4
428.3	210.6	0.6	0.3
412.5	210.4	0.6	0.3
396.6	210.3	0.6	0.3
380.7	210.1	0.5	0.3
364.9	210.0	0.5	0.2
349.0	209.8	0.5	0.2
333.2	209.7	0.4	0.2
317.3	209.5	0.4	0.2
301.4	209.3	0.4	0.2
285.6	209.2	0.3	0.2
269.7	209.0	0.3	0.1
253.8	208.8	0.3	0.1
238.0	208.6	0.2	0.1
222.1	208.4	0.2	0.1
206.2	208.3	0.2	0.1
190.4	208.0	0.2	0.1
174.5	207.8	0.1	0.0
156.6	207.6	0.1	0.0
142.8	207.4	0.1	0.0
126.9	207.1	0.1	0.0
111.1	206.9	0.0	0.0
95.2	206.6	0.0	0.0
79.3	206.3	0.0	0.0
63.5	206.0	0.0	0.0
47.6	205.6	0.0	0.0
31.7	205.2	0.0	0.0
15.9	204.6	0.0	0.0

M M M E U M E U E E E M K H E E L L E



F F F F F F F F F F F F F F F F

F F F F F F F F F F F F F F F F

F F F F F F F F F F F F F F F F

F F F F F F F F F F F F F F F F

F F F F F F F F F F F F F F F F

5.3 IM RCS
PROPELLANT TABLES

F F F F F F F F F F F F F F F F

LUNAR MODULE RCS PROPELLANT

MASS PROPERTIES

NOTE:

1. Mass Properties are given for liquid in individual tanks.
2. Moments of Inertia are about center of gravity of propellant in individual tanks, coordinates of which are given.
3. Centers of Gravity in Y and Z directions are given at top of each page.
4. The number of tanks of a particular kind is indicated by the last number on the first line of each page.

M M

LM RCS FUEL MASS PROPERTIES-70°F-2 TANKS
 Y-CG = + OR - 44.6 (CONST) Z-CG = + OR - 14.5

RADIUS= 6.250 CYLINDRICAL SECITON= 18.650. WEIGHT= 103.7
 DENSITY= 56.330 LBS/CU.FT.

(ULLAGE/(VOL.OF LIQUID))x100= 4.093

WEIGHT	X-CG	IXX(S-FT.SQ)	IYY or IZZ(S-FT.SQ)
103.7	279.3	0.0	0.4
103.2	279.2	0.0	0.5
102.7	279.2	0.0	0.5
102.1	279.1	0.0	0.5
101.6	279.0	0.0	0.5
101.1	279.0	0.0	0.5
100.6	278.9	0.0	0.5
100.1	278.8	0.0	0.5
99.6	278.8	0.0	0.4
99.0	278.7	0.0	0.4
98.5	278.7	0.0	0.3
98.0	278.6	0.0	0.4
97.5	278.5	0.0	0.4
97.0	278.5	0.0	0.4
96.4	278.4	0.0	0.4
95.9	278.3	0.0	0.4
95.4	278.3	0.0	0.4
94.9	278.2	0.0	0.4
94.4	278.1	0.0	0.4
93.8	278.1	0.0	0.4
93.3	278.0	0.0	0.4
92.8	277.9	0.0	0.4
92.3	277.9	0.0	0.4
91.8	277.8	0.0	0.3
91.3	277.7	0.0	0.3
90.7	277.7	0.0	0.3
90.2	277.6	0.0	0.3
89.7	277.5	0.0	0.3
89.2	277.5	0.0	0.3
88.7	277.4	0.0	0.3
88.1	277.4	0.0	0.3
87.6	277.3	0.0	0.3
87.1	277.2	0.0	0.3
86.6	277.2	0.0	0.3
86.1	277.1	0.0	0.3
85.6	277.0	0.0	0.3
85.0	277.0	0.0	0.3
84.5	276.9	0.0	0.2
84.0	276.8	0.0	0.2
83.5	276.8	0.0	0.2
83.0	276.7	0.0	0.2
82.4	276.6	0.0	0.2
81.9	276.6	0.0	0.2



LM RCS FUEL MASS PROPERTIES-70°F-2 TANKS
Y-CG = + OR - 44.6 (CONST) Z-CG = + OR - 14.5

RADIUS= 6.250 CYLINDRICAL SECTION= 18.650, WEIGHT= 103.7
DENSITY= 56.330 LBS/CU.FT.

WEIGHT	X-CG	IXX(S-FT.SQ)	IYY or IZZ(S-FT.SQ)
81.4	276.5	0.0	0.2
80.9	276.4	0.0	0.2
80.4	276.4	0.0	0.2
79.8	276.3	0.0	0.2
79.3	276.2	0.0	0.2
78.8	276.2	0.0	0.2
78.3	276.1	0.0	0.2
77.8	276.0	0.0	0.2
77.3	276.0	0.0	0.2
76.7	275.9	0.0	0.2
76.2	275.9	0.0	0.2
75.7	275.8	0.0	0.1
75.2	275.7	0.0	0.1
74.7	275.7	0.0	0.1
74.1	275.6	0.0	0.1
73.6	275.5	0.0	0.1
73.1	275.5	0.0	0.1
72.6	275.4	0.0	0.1
72.1	275.3	0.0	0.1
71.6	275.3	0.0	0.1
71.0	275.2	0.0	0.1
70.5	275.1	0.0	0.1
70.0	275.1	0.0	0.1
69.5	275.0	0.0	0.1
69.0	274.9	0.0	0.1
68.4	274.9	0.0	0.1
67.9	274.8	0.0	0.1
67.4	274.7	0.0	0.1
66.9	274.7	0.0	0.1
66.4	274.6	0.0	0.1
65.8	274.5	0.0	0.1
65.3	274.5	0.0	0.1
64.8	274.4	0.0	0.1
64.3	274.4	0.0	0.1
63.8	274.3	0.0	0.1
63.3	274.2	0.0	0.1
62.7	274.2	0.0	0.1
62.2	274.1	0.0	0.1
61.7	274.0	0.0	0.0
61.2	274.0	0.0	0.0
60.7	273.9	0.0	0.0
60.1	273.8	0.0	0.0
59.6	273.8	0.0	0.0

U U U U U U U U U U U U U U U U U U U U

LM RCS FUEL MASS PROPERTIES-70°F-2 TANKS
Y-CG = + OR - 44.6 (CONST) Z-CG = + OR - 14.5

RADIUS= 6.250 CYLINDRICAL SECTION= 18.650. WEIGHT = 103.7
DENSITY= 56.330 LBS/CU.FT.

WEIGHT	X-CG	IXX(S-FT.SQ)	IYY or IZZ(S-FT.SQ)
59.1	273.7	0.0	0.0
58.6	273.6	0.0	0.0
58.1	273.6	0.0	0.0
57.6	273.5	0.0	0.0
57.0	273.4	0.0	0.0
56.5	273.4	0.0	0.0
56.0	273.3	0.0	0.0
55.5	273.2	0.0	0.0
55.0	273.2	0.0	0.0
54.4	273.1	0.0	0.0
53.9	273.0	0.0	0.0
53.4	273.0	0.0	0.0
52.9	272.9	0.0	0.0
52.4	272.8	0.0	0.0
51.8	272.8	0.0	0.0
51.3	272.7	0.0	0.0
50.8	272.6	0.0	0.0
50.3	272.6	0.0	0.0
49.8	272.5	0.0	0.0
49.3	272.5	0.0	0.0
48.7	272.4	0.0	0.0
48.2	272.3	0.0	0.0
47.7	272.3	0.0	0.0
47.2	272.2	0.0	0.0
46.7	272.1	0.0	0.0
46.1	272.1	0.0	0.0
45.6	272.0	0.0	0.0
45.1	271.9	0.0	0.0
44.6	271.9	0.0	0.0
44.1	271.8	0.0	0.0
43.6	271.7	0.0	0.0
43.0	271.7	0.0	0.0
42.5	271.6	0.0	0.0
42.0	271.5	0.0	0.0
41.5	271.5	0.0	0.0
41.0	271.4	0.0	0.0
40.4	271.3	0.0	0.0
39.9	271.3	0.0	0.0
39.4	271.2	0.0	0.0
38.9	271.1	0.0	0.0
38.4	271.1	0.0	0.0
37.9	271.0	0.0	0.0
37.3	270.9	0.0	0.0

U U

LM RCS FUEL MASS PROPERTIES-70°F-2 TANKS
 Y-CG = + OR - 44.6 (CONST) Z-CG = + OR - 14.5

RADIUS= 6.250 CYLINDRICAL SECTION= 18.560. WEIGHT= 103.7
 DENSITY= 56.330 LBS/CU.FT.

WEIGHT	X-CG	IXX(S-FT.SQ)	IYY or IZZ(S-FT.SQ)
36.8	270.9	0.0	0.0
36.3	270.8	0.0	0.0
35.8	270.7	0.0	0.0
35.3	270.7	0.0	0.0
34.7	270.6	0.0	0.0
34.2	270.5	0.0	0.0
33.7	270.5	0.0	0.0
33.2	270.4	0.0	0.0
32.7	270.3	0.0	0.0
32.1	270.3	0.0	0.0
31.6	270.2	0.0	0.0
31.1	270.1	0.0	0.0
30.6	270.1	0.0	0.0
30.1	270.0	0.0	0.0
29.6	269.9	0.0	0.0
29.0	269.9	0.0	0.0
28.5	269.8	0.0	0.0
28.0	269.7	0.0	0.0
27.5	269.7	0.0	0.0
27.0	269.6	0.0	0.0
26.4	269.5	0.0	0.0
25.9	269.5	0.0	0.0
25.4	269.4	0.0	0.0
24.9	269.3	0.0	0.0
24.4	269.3	0.0	0.0
23.9	269.2	0.0	0.0
23.3	269.1	0.0	0.0
22.8	269.0	0.0	0.0
22.3	269.0	0.0	0.0
21.8	268.9	0.0	0.0
21.3	268.8	0.0	0.0
20.7	268.8	0.0	0.0
20.2	268.7	0.0	0.0
19.7	268.6	0.0	0.0
19.2	268.6	0.0	0.0
18.7	268.5	0.0	0.0
18.1	268.4	0.0	0.0
17.6	268.3	0.0	0.0
17.1	268.3	0.0	0.0
16.6	268.2	0.0	0.0
16.1	268.1	0.0	0.0
15.6	268.0	0.0	0.0
15.0	268.0	0.0	0.0



LM RCS FUEL MASS PROPERTIES-70°F-2 TANKS
Y-CG = + OR - 44.6 (CONST) Z-CG = + OR - 14.5

RADIUS= 6.250 CYLINDRICAL SECTION= 18.650. WEIGHT= 103.7
DENSITY= 56.330 LBS/CU.FT.

WEIGHT	X-CG	IXX(S-FT.SQ)	IYY or IZZ(S-FT.SQ)
14.5	267.9	0.0	0.0
14.0	267.8	0.0	0.0
13.5	267.7	0.0	0.0
13.0	267.7	0.0	0.0
12.4	267.6	0.0	0.0
11.9	267.5	0.0	0.0
11.4	267.4	0.0	0.0
10.9	267.3	0.0	0.0
10.4	267.3	0.0	0.0
9.9	267.2	0.0	0.0
9.3	267.1	0.0	0.0
8.8	267.0	0.0	0.0
8.3	266.9	0.0	0.0
7.8	266.8	0.0	0.0
7.3	266.7	0.0	0.0
6.7	266.6	0.0	0.0
6.2	266.5	0.0	0.0
5.7	266.4	0.0	0.0
5.2	266.3	0.0	0.0
4.7	266.2	0.0	0.0
4.1	266.1	0.0	0.0
3.6	266.0	0.0	0.0
3.1	265.8	0.0	0.0
2.6	265.7	0.0	0.0
2.1	265.5	0.0	0.0
1.6	265.4	0.0	0.0
1.0	265.2	0.0	0.0
0.5	264.9	0.0	0.0

LM RCS OXIDIZER MASS PROPERTIES-70°F-2 TANKS
 Y-CG = + OR - 44.6 (CONST) Z-CG = - OR + 14.5

RADIUS= 6.250 CYLINDRICAL SECTION= 25.260. WEIGHT= 203.4
 DENSITY= 90.050 LBS/CU.FT.

(ULLAGE/(VOL.OF LIQUID))x100= 5.621

WEIGHT	X-CG	IXX(S-FT.SQ)	IYY or IZZ(S-FT.SQ)
203.4	275.7	0.0	1.4
202.4	275.6	0.0	1.4
201.4	275.5	0.0	1.4
200.3	275.4	0.0	1.4
199.3	275.3	0.0	1.4
198.3	275.3	0.0	1.3
197.3	275.2	0.0	1.3
196.3	275.1	0.0	1.3
195.3	275.0	0.0	1.3
194.2	274.9	0.0	1.3
193.2	274.9	0.0	1.2
192.2	274.8	0.0	1.2
191.2	274.7	0.0	1.2
190.2	274.6	0.0	1.2
189.2	274.5	0.0	1.2
188.1	274.5	0.0	1.2
187.1	274.4	0.0	1.1
186.1	274.3	0.0	1.1
185.1	274.2	0.0	1.1
184.1	274.1	0.0	1.1
183.1	274.1	0.0	1.0
182.0	274.0	0.0	1.0
181.0	273.9	0.0	1.0
180.0	273.8	0.0	1.0
179.0	273.7	0.0	1.0
178.0	273.7	0.0	0.9
177.0	273.6	0.0	0.9
175.9	273.5	0.0	0.9
174.9	273.4	0.0	0.9
173.9	273.3	0.0	0.8
172.9	273.3	0.0	0.8
171.9	273.2	0.0	0.8
170.9	273.1	0.0	0.8
169.8	273.0	0.0	0.8
168.8	272.9	0.0	0.8
167.8	272.9	0.0	0.7
166.8	272.8	0.0	0.7
165.8	272.7	0.0	0.7
164.8	272.6	0.0	0.7
163.7	272.5	0.0	0.7
162.7	272.5	0.0	0.7
161.7	272.4	0.0	0.6
160.7	272.3	0.0	0.6

U U

LM RCS OXIDIZER MASS PROPERTIES-70°F-2 TANKS
 Y-CG = + OR - 44.6 (CONST) Z-CG = - OR + 14.5

RADIUS= 6.250 CYLINDRICAL SECTION= 25.260. WEIGHT= 203.4
 DENSITY= 90.050 LBS/CU.FT.

WEIGHT	X-CG	IXX(S-FT.SQ)	IYY or IZZ(S-FT.SQ)
159.7	272.2	0.0	0.6
158.7	272.1	0.0	0.6
157.6	272.1	0.0	0.6
156.6	272.0	0.0	0.6
155.6	271.9	0.0	0.5
154.6	271.8	0.0	0.5
153.6	271.7	0.0	0.5
152.5	271.7	0.0	0.5
151.5	271.6	0.0	0.5
150.5	271.5	0.0	0.5
149.5	271.4	0.0	0.5
148.5	271.3	0.0	0.5
147.5	271.3	0.0	0.4
146.4	271.2	0.0	0.4
145.4	271.1	0.0	0.4
144.4	271.0	0.0	0.4
143.4	270.9	0.0	0.4
142.4	270.9	0.0	0.4
141.4	270.8	0.0	0.4
140.3	270.7	0.0	0.4
139.3	270.6	0.0	0.3
138.3	270.5	0.0	0.3
137.3	270.5	0.0	0.3
136.3	270.4	0.0	0.3
135.3	270.3	0.0	0.3
134.2	270.2	0.0	0.3
133.2	270.1	0.0	0.3
132.2	270.1	0.0	0.3
131.2	270.0	0.0	0.3
130.2	269.9	0.0	0.3
129.2	269.8	0.0	0.3
128.1	269.7	0.0	0.2
127.1	269.7	0.0	0.2
126.1	269.6	0.0	0.2
125.1	269.5	0.0	0.2
124.1	269.4	0.0	0.2
123.1	269.3	0.0	0.2
122.0	269.3	0.0	0.2
121.0	269.2	0.0	0.2
120.0	269.1	0.0	0.2
119.0	269.0	0.0	0.2
118.0	268.9	0.0	0.2
117.0	268.9	0.0	0.2

M M M M L

LM RCS OXIDIZER MASS PROPERTIES-70°F-2 TANKS
Y-CG = + OR - 44.6 (CONST) Z-CG = - OR + 14.5

RADIUS= 6.250 CYLINDRICAL SECTION= 25.260. WEIGHT= 203.4
DENSITY= 90.050 LBS/CU.FT.

WEIGHT	X-CG	IXX(S-FT.SQ)	IYY or IZZ(S-FT.SQ)
115.9	268.8	0.0	0.2
114.9	268.7	0.0	0.2
113.9	268.6	0.0	0.1
112.9	268.5	0.0	0.1
111.9	268.5	0.0	0.1
110.9	268.4	0.0	0.1
109.8	268.3	0.0	0.1
108.8	268.2	0.0	0.1
107.8	268.1	0.0	0.1
106.8	268.1	0.0	0.1
105.8	268.0	0.0	0.1
104.8	267.9	0.0	0.1
103.7	267.8	0.0	0.1
102.7	267.7	0.0	0.1
101.7	267.7	0.0	0.1
100.7	267.6	0.0	0.1
99.7	267.5	0.0	0.1
98.6	267.4	0.0	0.1
97.6	267.3	0.0	0.1
96.6	267.3	0.0	0.1
95.6	267.2	0.0	0.1
94.6	267.1	0.0	0.1
93.6	267.0	0.0	0.1
92.5	266.9	0.0	0.0
91.5	266.9	0.0	0.0
90.5	266.8	0.0	0.0
89.5	266.7	0.0	0.0
88.5	266.6	0.0	0.0
87.5	266.5	0.0	0.0
86.4	266.5	0.0	0.0
85.4	266.4	0.0	0.0
84.4	266.3	0.0	0.0
83.4	266.2	0.0	0.0
82.4	266.1	0.0	0.0
81.4	266.1	0.0	0.0
80.3	266.0	0.0	0.0
79.3	265.9	0.0	0.0
78.3	265.8	0.0	0.0
77.3	265.7	0.0	0.0
76.3	265.7	0.0	0.0
75.3	265.6	0.0	0.0
74.2	265.5	0.0	0.0
73.2	265.4	0.0	0.0

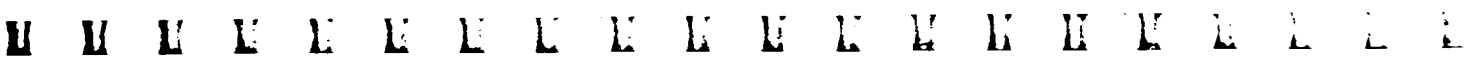

LM RCS OXIDIZER MASS PROPERTIES-70°F-2 TANKS
Y-CG = + OR - 44.6 (CONST) Z-CG = - OR + 14.5

RADIUS= 6.250 CYLINDRICAL SECTION= 25.260. WEIGHT= 203.4
DENSITY= 90.050 LBS/CU.FT.

WEIGHT	X-CG	IXX(S-FT.SQ)	IYY or IZZ(S-FT.SQ)
72.2	265.3	0.0	0.0
71.2	265.3	0.0	0.0
70.2	265.2	0.0	0.0
69.2	265.1	0.0	0.0
68.1	265.0	0.0	0.0
67.1	264.9	0.0	0.0
66.1	264.8	0.0	0.0
65.1	264.8	0.0	0.0
64.1	264.7	0.0	0.0
63.1	264.6	0.0	0.0
62.0	264.5	0.0	0.0
61.0	264.4	0.0	0.0
60.0	264.4	0.0	0.0
59.0	264.3	0.0	0.0
58.0	264.2	0.0	0.0
57.0	264.1	0.0	0.0
55.9	264.0	0.0	0.0
54.9	264.0	0.0	0.0
53.9	263.9	0.0	0.0
52.9	263.8	0.0	0.0
51.9	263.7	0.0	0.0
50.8	263.6	0.0	0.0
49.8	263.5	0.0	0.0
48.8	263.5	0.0	0.0
47.8	263.4	0.0	0.0
46.8	263.3	0.0	0.0
45.8	263.2	0.0	0.0
44.7	263.1	0.0	0.0
43.7	263.0	0.0	0.0
42.7	263.0	0.0	0.0
41.7	262.9	0.0	0.0
40.7	262.8	0.0	0.0
39.7	262.7	0.0	0.0
38.6	262.6	0.0	0.0
37.6	262.5	0.0	0.0
36.6	262.5	0.0	0.0
35.6	262.4	0.0	0.0
34.6	262.3	0.0	0.0
33.6	262.2	0.0	0.0
32.5	262.1	0.0	0.0
31.5	262.0	0.0	0.0
30.5	261.9	0.0	0.0
29.5	261.9	0.0	0.0

U U

LM RCS OXIDIZER MASS PROPERTIES-70°F-2 TANKS
 Y-CG = + OR - 44.6 (CONST) Z-CG = - OR + 14.5

RADIUS= 6.250 CYLINDRICAL SECTION= 25.260. WEIGHT= 203.4
 DENSITY= 90.050 LBS/CU.FT.

WEIGHT	X-CG	IXX(S-FT.SQ)	IYY or IZZ(S-FT.SQ)
28.5	261.8	0.0	0.0
27.5	261.7	0.0	0.0
26.4	261.6	0.0	0.0
25.4	261.5	0.0	0.0
24.4	261.4	0.0	0.0
23.4	261.3	0.0	0.0
22.4	261.2	0.0	0.0
21.4	261.1	0.0	0.0
20.3	261.0	0.0	0.0
19.3	260.9	0.0	0.0
18.3	260.8	0.0	0.0
17.3	260.7	0.0	0.0
16.3	260.6	0.0	0.0
15.3	260.5	0.0	0.0
14.2	260.4	0.0	0.0
13.2	260.3	0.0	0.0
12.2	260.2	0.0	0.0
11.2	260.1	0.0	0.0
10.2	260.0	0.0	0.0
9.2	259.8	0.0	0.0
8.1	259.7	0.0	0.0
7.1	259.6	0.0	0.0
6.1	259.4	0.0	0.0
5.1	259.3	0.0	0.0
4.1	259.1	0.0	0.0
3.1	258.9	0.0	0.0
2.0	258.7	0.0	0.0
1.0	258.4	0.0	0.0



U U U E E E E E E E E E E U U U E E E E

1 1 1

1 1 1 1 1 1

1 1 1 1 1 1 1 1

1 1 1 1 1 1 1 1 1 1

1 1 1 1 1 1 1 1 1 1 1 1

1 1 1 1 1 1 1 1 1 1 1 1 1 1 1 1 1 1

TABLE 5.4-1

LM-8 DESCENT WATER MASS PROPERTIES-1 TANK
Y-CG = -43.2 (CONST) Z-CG = -43.2 (CONST)

RADIUS= 14.200 CYLINDRICAL SECTION= 0.0 WEIGHT= 323.8
DENSITY= 62.400 LBS/CU.FT.

(ULLAGE/VOL.OF LIQUID))x100= 33.757

WEIGHT	X-CG	IXX(S-FT.SQ)	IYY or IZZ(S-FT.SQ)
323.8	165.8	0.3	0.2
322.2	165.8	0.2	0.2
320.6	165.8	0.2	0.2
318.9	165.7	0.2	0.2
317.3	165.7	0.2	0.2
315.7	165.6	0.2	0.2
314.1	165.6	0.2	0.2
312.5	165.6	0.2	0.2
310.8	165.5	0.2	0.2
309.2	165.5	0.2	0.2
307.6	165.4	0.2	0.2
306.0	165.4	0.2	0.2
304.4	165.4	0.2	0.2
302.8	165.3	0.2	0.2
301.1	165.3	0.2	0.2
299.5	165.3	0.2	0.2
297.9	165.2	0.2	0.1
296.3	165.2	0.2	0.1
294.7	165.1	0.2	0.1
293.0	165.1	0.2	0.1
291.4	165.1	0.2	0.1
289.6	165.0	0.2	0.1
288.7	165.0	0.2	0.1
286.6	165.0	0.2	0.1
284.9	164.9	0.2	0.1
283.3	164.9	0.2	0.1
281.7	164.8	0.2	0.1
280.1	164.8	0.2	0.1
278.5	164.8	0.2	0.1
276.8	164.7	0.2	0.1
275.2	164.7	0.2	0.1
273.6	164.6	0.2	0.1
272.0	164.6	0.2	0.1
270.4	164.6	0.2	0.1
268.8	164.5	0.2	0.1
267.1	164.5	0.2	0.1
265.5	164.5	0.2	0.1
263.9	164.4	0.2	0.1
262.3	164.4	0.2	0.1
260.7	164.3	0.2	0.1
259.0	164.3	0.2	0.1
257.4	164.3	0.2	0.1
255.8	164.2	0.2	0.1



TABLE 5.4-1 (Continued)

LM-8 DESCENT WATER MASS PROPERTIES-1 TANK
Y-CG = -43.2 (CONST) Z-CG = -43.2 (CONST)

RADIUS= 14.200 CYLINDRICAL SECTION= 0.0 WEIGHT= 323.8
DENSITY= 62.400 LBS/CU.FT.

WEIGHT	X-CG	IXX(S-FT.SQ)	IYY or IZZ(S-FT.SQ)
254.2	164.2	0.2	0.1
252.6	164.1	0.2	0.1
250.9	164.1	0.2	0.1
249.3	164.1	0.2	0.1
247.7	164.0	0.2	0.1
246.1	164.0	0.2	0.1
244.5	164.0	0.2	0.1
242.8	163.9	0.2	0.1
241.2	163.9	0.2	0.1
239.6	163.8	0.2	0.1
238.0	163.8	0.2	0.1
236.4	163.8	0.2	0.1
234.8	163.7	0.2	0.1
233.1	163.7	0.2	0.1
231.5	163.6	0.2	0.1
229.9	163.6	0.2	0.1
228.3	163.6	0.2	0.1
226.7	163.5	0.1	0.1
225.0	163.5	0.1	0.1
223.4	163.4	0.1	0.1
221.8	163.4	0.1	0.1
220.2	163.4	0.1	0.1
218.6	163.3	0.1	0.1
216.9	163.3	0.1	0.1
215.3	163.2	0.1	0.1
213.7	163.2	0.1	0.1
212.1	163.2	0.1	0.1
210.5	163.1	0.1	0.1
208.9	163.1	0.1	0.1
207.2	163.0	0.1	0.1
205.6	163.0	0.1	0.1
204.0	163.0	0.1	0.1
202.4	162.9	0.1	0.1
200.8	162.9	0.1	0.1
199.1	162.8	0.1	0.1
197.5	162.8	0.1	0.1
195.9	162.8	0.1	0.1
194.3	162.7	0.1	0.1
192.7	162.7	0.1	0.1
191.0	162.6	0.1	0.1
189.4	162.6	0.1	0.1
187.8	162.6	0.1	0.0
186.2	162.5	0.1	0.0



TABLE 5.4-1 (Continued)

Amendment 86
9/10/70

LM-8 DESCENT WATER MASS PROPERTIES-1 TANK
Y-CG = -43.2 (CONST) Z-CG = -43.2 (CONST)

RADIUS= 14.200 CYLINDRICAL SECTION= 0.0 WEIGHT= 323.8
DENSITY= 62.400 LBS/CU.FT.

WEIGHT	X-CG	IXX(S-FT. SQ)	IYY or IZZ(S-FT.SQ)
184.6	162.5	0.1	0.0
182.9	162.4	0.1	0.0
181.3	162.4	0.1	0.0
179.7	162.3	0.1	0.0
178.1	162.3	0.1	0.0
176.5	162.3	0.1	0.0
174.9	162.2	0.1	0.0
173.2	162.2	0.1	0.0
171.6	162.1	0.1	0.0
170.0	162.1	0.1	0.0
168.4	162.1	0.1	0.0
166.8	162.0	0.1	0.0
165.1	162.0	0.1	0.0
163.5	161.9	0.1	0.0
161.9	161.9	0.1	0.0
160.3	161.8	0.1	0.0
158.7	161.8	0.1	0.0
157.0	161.8	0.1	0.0
155.4	161.7	0.1	0.0
153.8	161.7	0.1	0.0
152.2	161.6	0.1	0.0
150.6	161.6	0.1	0.0
148.9	161.5	0.1	0.0
147.3	161.5	0.1	0.0
145.7	161.4	0.1	0.0
144.1	161.4	0.1	0.0
142.5	161.4	0.1	0.0
140.9	161.3	0.1	0.0
139.2	161.3	0.1	0.0
137.6	161.2	0.1	0.0
136.0	161.2	0.1	0.0
134.4	161.1	0.1	0.0
132.8	161.1	0.0	0.0
131.1	161.0	0.0	0.0
129.5	161.0	0.0	0.0
127.9	160.9	0.0	0.0
126.3	160.9	0.0	0.0
124.7	160.9	0.0	0.0
123.0	160.8	0.0	0.0
121.4	160.8	0.0	0.0
119.8	160.7	0.0	0.0
118.2	160.7	0.0	0.0
116.6	160.6	0.0	0.0



TABLE 5.4-1 (Continued)

LM-8 DESCENT WATER MASS PROPERTIES-1 TANK
Y-CG = -43.2 (CONST) Z-CG = -43.2 (CONST)

RADIUS= 14.200 CYLINDRICAL SECTION= 0.0 WEIGHT= 323.8
DENSITY= 62.400 LBS/CU.FT.

WEIGHT	X-CG	IXX(S-FT.SQ)	IYY or IZZ(S-FT.SQ)
114.9	160.6	0.0	0.0
113.3	160.5	0.0	0.0
111.7	160.5	0.0	0.0
110.1	160.4	0.0	0.0
108.5	160.4	0.0	0.0
106.9	160.3	0.0	0.0
105.2	160.3	0.0	0.0
103.6	160.2	0.0	0.0
102.0	160.2	0.0	0.0
100.4	160.1	0.0	0.0
98.8	160.0	0.0	0.0
97.1	160.0	0.0	0.0
95.5	160.0	0.0	0.0
93.9	159.9	0.0	0.0
92.3	159.9	0.0	0.0
90.9	159.8	0.0	0.0
89.0	159.8	0.0	0.0
87.4	159.7	0.0	0.0
85.8	159.6	0.0	0.0
84.2	159.6	0.0	0.0
82.6	159.5	0.0	0.0
80.9	159.5	0.0	0.0
79.3	159.4	0.0	0.0
77.7	159.4	0.0	0.0
76.1	159.3	0.0	0.0
74.5	159.3	0.0	0.0
72.9	159.2	0.0	0.0
71.2	159.1	0.0	0.0
69.6	159.1	0.0	0.0
68.0	159.0	0.0	0.0
66.4	159.0	0.0	0.0
64.8	158.9	0.0	0.0
63.1	158.8	0.0	0.0
61.5	158.8	0.0	0.0
59.9	158.7	0.0	0.0
58.3	158.7	0.0	0.0
56.7	158.6	0.0	0.0
55.0	158.5	0.0	0.0
53.4	158.5	0.0	0.0
51.8	158.4	0.0	0.0
50.2	158.3	0.0	0.0
48.6	158.3	0.0	0.0
47.0	158.2	0.0	0.0

U U

TABLE 5.4-1 (Continued)

LM-8 DESCENT WATER MASS PROPERTIES-1 TANK.
Y-CG = -43.2 (CONST) Z-CG = -43.2 (CONST)

RADIUS= 14.200 CYLINDRICAL SECTION= 0.0 . WEIGHT= 323.8
DENSITY= 62.400 LBS/CU.FT.

WEIGHT	X-CG	IXX(S-FT.SQ.)	IYY or IZZ(S-FT.SQ.)
45.3	158.1	0.0	0.0
43.7	158.1	0.0	0.0
42.1	158.0	0.0	0.0
40.5	157.9	0.0	0.0
38.9	157.8	0.0	0.0
37.2	157.8	0.0	0.0
35.6	157.7	0.0	0.0
34.0	157.6	0.0	0.0
32.4	157.5	0.0	0.0
30.8	157.4	0.0	0.0
29.1	157.4	0.0	0.0
27.5	157.3	0.0	0.0
25.9	157.2	0.0	0.0
24.3	157.1	0.0	0.0
22.7	157.0	0.0	0.0
21.0	156.9	0.0	0.0
19.4	156.8	0.0	0.0
17.8	156.7	0.0	0.0
16.2	156.6	0.0	0.0
14.6	156.5	0.0	0.0
13.0	156.3	0.0	0.0
11.3	156.2	0.0	0.0
9.7	156.1	0.0	0.0
8.1	155.9	0.0	0.0
6.5	155.8	0.0	0.0
4.9	155.6	0.0	0.0
3.2	155.4	0.0	0.0
1.6	155.1	0.0	0.0

U U

TABLE 5.4-2

LM 10 AND SUBSEQUENT DESCENT STAGE WATER MASS PROPERTIES

RADIUS = 14.2 INCHES

DENSITY = 62.4 LBS/CU. FT. WEIGHT = 323.8 POUNDS

TANK NO. 1 Y-CG = -43.2 (CONSTANT)

TANK NO. 2 Y-CG = 43.2 (CONSTANT)

Z-CG = -43.2 (CONSTANT)

Z-CG = 43.2 (CONSTANT)

(ULLAGE/(VOLUME OF LIQUID)) X 100 = 37.757

<u>Weight Pounds</u>	<u>Tank-1 X-CG</u>	<u>Tank-2 X-CG</u>	<u>Height Inches</u>
333.0	166.0	142.9	19.542
323.8	165.8	142.7	19.080
322.2	165.8	142.7	19.000
320.6	165.8	142.7	18.921
318.9	165.7	142.6	18.841
317.3	165.7	142.6	18.762
315.7	165.6	142.5	18.683
314.1	165.6	142.5	18.605
312.5	165.6	142.5	18.527
310.8	165.5	142.4	18.449
309.2	165.5	142.4	18.371
307.6	165.4	142.3	18.294
806.0	165.4	142.3	18.217
304.4	165.4	142.3	18.140
302.8	165.3	142.2	18.064
301.1	165.3	142.2	17.987
299.5	165.3	142.2	17.911
297.9	165.2	142.1	17.835
296.3	165.2	142.1	17.760
294.7	165.1	142.0	17.684
293.0	165.1	142.0	17.609
291.4	165.1	142.0	17.534
289.8	165.0	141.9	17.459
288.2	165.0	141.9	17.385
286.6	165.0	141.9	17.310
284.9	164.9	141.8	17.236
283.3	164.9	141.8	17.162
281.7	164.8	141.7	17.088
280.1	164.8	141.7	17.014
278.5	164.8	141.7	16.941
276.8	164.7	141.6	16.867
275.2	164.7	141.6	16.794
273.6	164.6	141.5	16.721
272.0	164.6	141.5	16.648
270.4	164.6	141.5	16.575
268.8	164.5	141.4	16.502
267.1	164.5	141.4	16.430
265.5	164.5	141.4	16.357

M U L L L L L L L L L L L L L L L L L

TABLE 5.4-2 (Continued)

LM 10 AND SUBSEQUENT DESCENT STAGE WATER MASS PROPERTIES

RADIUS = 14.2 INCHES DENSITY = 62.4 LBS/CU. FT. WEIGHT = 323.8 POUNDS
TANK NO. 1 Y-CG = -43.2 (CONSTANT) TANK NO. 2 Y-CG = 43.2 (CONSTANT)
 Z-CG = -43.2 (CONSTANT) Z-CG = 43.2 (CONSTANT)
(ULLAGE/(VOLUME OF LIQUID)) X 100 = 37.757

<u>Weight Pounds</u>	<u>Tank-1 X-CG</u>	<u>Tank-2 X-CG</u>	<u>Height Inches</u>
144.1	161.4	138.3	10.977
142.5	161.4	138.3	10.902
140.9	161.3	138.2	10.827
139.2	161.3	138.2	10.752
137.6	161.2	138.1	10.677
136.0	161.2	138.1	10.601
134.4	161.1	138.0	10.526
132.8	161.1	138.0	10.450
131.1	161.0	137.9	10.373
129.5	161.0	137.9	10.297
127.9	160.9	137.8	10.220
126.3	160.9	137.8	10.143
124.7	160.9	137.8	10.066
123.0	160.8	137.7	9.989
121.4	160.8	137.7	9.911
119.8	160.7	137.6	9.833
118.2	160.7	137.6	9.755
116.6	160.6	137.5	9.676
114.9	160.6	137.5	9.597
113.3	160.5	137.4	9.518
111.7	160.5	137.4	9.438
110.1	160.4	137.3	9.358
108.5	160.4	137.3	9.278
106.9	160.3	137.2	9.198
105.2	160.3	137.2	9.117
103.6	160.2	137.1	8.035
102.0	160.2	137.1	8.953
100.4	160.1	137.0	8.871
98.8	160.1	137.0	8.789
97.1	160.0	136.9	8.706
95.5	160.0	136.9	8.622
93.9	159.9	136.8	8.538
92.3	159.9	136.8	8.454
90.7	159.8	136.7	8.369
89.0	159.8	136.7	8.284
87.4	159.7	136.6	8.198
85.8	159.6	136.5	8.111
84.2	159.6	136.5	8.024
82.6	159.5	136.4	7.937
80.9	159.5	136.4	7.849
79.3	159.4	136.3	7.760

U U U U U U U U U U U U U U U U U

5.5 LM ASCENT
WATER TABLES

0 1 2 3 4 5 6 7 8 9

1 2 3 4 5 6 7 8 9

1 2 3 4 5 6 7 8 9

1 2 3 4 5 6 7 8 9

1 2 3 4 5 6 7 8 9

LUNAR MODULE ASCENT WATER

MASS PROPERTIES

NOTE:

1. Mass Properties are given for liquids in individual tanks.
2. Moments of Inertia are about center of gravity of water in individual tanks, coordinates of which are given.
3. Centers of Gravity in Y and Z directions are given at top of each page.
4. The number of tanks of a particular kind is indicated by the last number on the first line of each page.

LM ASCENT WATER MASS PROPERTIES-2 TANKS

Y-CG = + OR - 25.0 (CONST) Z-CG = + OR - 13.7 (CONST)

RADIUS= 7.155 CYLINDRICAL SECTION= 0.0 WEIGHT= 41.2

DENSITY= 62.400 LBS/CU.FT.

WEIGHT	X-CG	IXX(S-FT.SQ.)	IYY or IZZ(S-FT.SQ.)
32.3	299.5	0.0	0.0
32.1	299.5	0.0	0.0
31.9	299.5	0.0	0.0
31.7	299.5	0.0	0.0
31.5	299.4	0.0	0.0
31.3	299.4	0.0	0.0
31.1	299.4	0.0	0.0
30.9	299.4	0.0	0.0
30.7	299.4	0.0	0.0
30.5	299.3	0.0	0.0
30.3	299.3	0.0	0.0
30.1	299.3	0.0	0.0
29.9	299.3	0.0	0.0
29.7	299.3	0.0	0.0
29.5	299.2	0.0	0.0
29.3	299.2	0.0	0.0
29.0	299.2	0.0	0.0
28.8	299.2	0.0	0.0
28.6	299.2	0.0	0.0
28.4	299.1	0.0	0.0
28.2	299.1	0.0	0.0
28.0	299.1	0.0	0.0
27.8	299.1	0.0	0.0
27.6	299.1	0.0	0.0
27.4	299.0	0.0	0.0
27.2	299.0	0.0	0.0
27.0	299.0	0.0	0.0
26.8	299.0	0.0	0.0
26.6	299.0	0.0	0.0
26.4	298.9	0.0	0.0
26.2	298.9	0.0	0.0
26.0	298.9	0.0	0.0
25.7	298.9	0.0	0.0
25.5	298.9	0.0	0.0
25.3	298.8	0.0	0.0
25.1	298.8	0.0	0.0
24.9	298.8	0.0	0.0
24.7	298.8	0.0	0.0
24.5	298.8	0.0	0.0
24.3	298.7	0.0	0.0
24.1	298.7	0.0	0.0
23.9	298.7	0.0	0.0
23.7	298.7	0.0	0.0



LM ASCENT WATER MASS PROPERTIES-2 TANKS

Y-CG = + OR - 25.0 (CONST) Z-CG = + OR - 13.7 (CONST)

RADIUS= 7.155 CYLINDRICAL SECTION= 0.0 WEIGHT= 41.2

DENSITY= 62.400 LBS/CU.FT.

WEIGHT	X-CG	IXX(S-FT.SQ.)	IYY or IZZ(S-FT.SQ.)
23.5	298.7	0.0	0.0
23.3	298.6	0.0	0.0
23.1	298.6	0.0	0.0
22.9	298.6	0.0	0.0
22.7	298.6	0.0	0.0
22.5	298.6	0.0	0.0
22.2	298.5	0.0	0.0
22.0	298.5	0.0	0.0
21.8	298.5	0.0	0.0
21.6	298.5	0.0	0.0
21.4	298.4	0.0	0.0
21.2	298.4	0.0	0.0
21.0	298.4	0.0	0.0
20.8	298.4	0.0	0.0
20.6	298.4	0.0	0.0
20.4	298.3	0.0	0.0
20.2	298.3	0.0	0.0
20.0	298.3	0.0	0.0
19.8	298.3	0.0	0.0
19.6	298.2	0.0	0.0
19.4	298.2	0.0	0.0
19.2	298.2	0.0	0.0
19.0	298.2	0.0	0.0
18.7	298.2	0.0	0.0
18.5	298.1	0.0	0.0
18.3	298.1	0.0	0.0
18.1	298.1	0.0	0.0
17.9	298.1	0.0	0.0
17.7	298.0	0.0	0.0
17.5	298.0	0.0	0.0
17.3	298.0	0.0	0.0
17.1	298.0	0.0	0.0
16.0	298.0	0.0	0.0
16.7	297.9	0.0	0.0
16.5	297.9	0.0	0.0
16.3	297.9	0.0	0.0
16.1	297.9	0.0	0.0
15.9	297.8	0.0	0.0
15.7	297.8	0.0	0.0
15.4	297.8	0.0	0.0
15.2	297.8	0.0	0.0
15.0	297.7	0.0	0.0
14.8	297.7	0.0	0.0

U U U E E E L L L E L U U U E L L E

LM ASCENT WATER MASS PROPERTIES-2 TANKS

Y-CG = + OR - 25.0 (CONST) Z-CG = + OR - 13.7 (CONST)

RADIUS= 7.155 CYLINDRICAL SECTION= 0.0 WEIGHT= 41.2
 DENSITY= 62.400 LBS/CU.FT.

WEIGHT	X-CG	IXX(S-FT.SQ.)	IYY or IZZ(S-FT.SQ.)
14.6	297.7	0.0	0.0
14.4	297.7	0.0	0.0
14.2	297.6	0.0	0.0
14.0	297.6	0.0	0.0
13.8	297.6	0.0	0.0
13.6	297.6	0.0	0.0
13.4	297.5	0.0	0.0
13.2	297.5	0.0	0.0
13.0	297.5	0.0	0.0
12.8	297.5	0.0	0.0
12.6	297.4	0.0	0.0
12.4	297.4	0.0	0.0
12.2	297.4	0.0	0.0
11.9	297.4	0.0	0.0
11.7	297.3	0.0	0.0
11.5	297.3	0.0	0.0
11.3	297.3	0.0	0.0
11.1	297.3	0.0	0.0
10.9	297.2	0.0	0.0
10.7	297.2	0.0	0.0
10.5	297.2	0.0	0.0
10.3	297.2	0.0	0.0
10.1	297.1	0.0	0.0
9.9	297.1	0.0	0.0
9.7	297.1	0.0	0.0
9.5	297.0	0.0	0.0
9.3	297.0	0.0	0.0
9.1	297.0	0.0	0.0
8.9	297.0	0.0	0.0
8.7	296.9	0.0	0.0
8.4	296.9	0.0	0.0
8.2	296.9	0.0	0.0
8.0	296.8	0.0	0.0
7.8	296.8	0.0	0.0
7.6	296.8	0.0	0.0
7.4	296.7	0.0	0.0
7.2	296.7	0.0	0.0
7.0	296.7	0.0	0.0
6.8	296.6	0.0	0.0
6.6	296.6	0.0	0.0
6.4	296.6	0.0	0.0
6.2	296.5	0.0	0.0
6.0	296.5	0.0	0.0

LM ASCENT WATER MASS PROPERTIES-2 TANKS

Y-CG = + OR - 25.0 (CONST) Z-CG = + OR - 13.7 (CONST)

RADIUS= 7.155 CYLINDRICAL SECTION= 0.0 WEIGHT= 41.2
 DENSITY= 62.400 LBS/CU.FT.

WEIGHT	X-CG	IXX(S-FT.SQ.)	IYY or IZZ (S-FT.SQ.)
5.8	296.5	0.0	0.0
5.6	296.4	0.0	0.0
5.4	296.4	0.0	0.0
5.1	296.4	0.0	0.0
4.9	296.3	0.0	0.0
4.7	296.3	0.0	0.0
4.5	296.2	0.0	0.0
4.3	296.2	0.0	0.0
4.1	296.2	0.0	0.0
3.9	296.1	0.0	0.0
3.7	296.1	0.0	0.0
3.5	296.0	0.0	0.0
3.3	296.0	0.0	0.0
3.1	295.9	0.0	0.0
2.9	295.9	0.0	0.0
2.7	295.9	0.0	0.0
2.5	295.8	0.0	0.0
2.3	295.7	0.0	0.0
2.1	295.7	0.0	0.0
1.9	295.6	0.0	0.0
1.6	295.6	0.0	0.0
1.4	295.5	0.0	0.0
1.2	295.4	0.0	0.0
1.0	295.4	0.0	0.0
0.8	295.3	0.0	0.0
0.6	295.2	0.0	0.0
0.4	295.1	0.0	0.0
0.2	294.9	0.0	0.0

U U



1 2 3 4 5 6 7 8 9 10

11 12 13 14 15

5.6 LM TRAPPED
PROPELLANTS & MISCELLAN-
EOUS CONSUMABLES

16 17 18 19 20

21 22 23 24 25 26 27 28 29 30

31 32 33 34 35 36 37 38 39 40 41 42 43 44 45 46 47 48 49 50

LUNAR MODULE TRAPPED AND RESIDUAL PROPELLANTS
AND MISCELLANEOUS CONSUMABLES

M M M E E E E E E E E E E M M M U E L L E

U
S
N
A
S
P
A
C
E
A
G
E
N
C
Y

TABLE 5.6-1

LUNAR MODULE TRAPPED AND RESIDUAL PROPELLANTS

<u>APS - Trapped Outside Tanks</u>	<u>WEIGHT</u> <u>(Pounds)</u>		<u>CENTER OF GRAVITY</u> <u>(Inches)</u>		
	<u>LM-5</u>	<u>LM-6 and Subs.</u>	<u>X_E</u>	<u>Y_E</u>	<u>Z_E</u>
Fill and Drain Lines - Fuel	0.2	0.2	218.5	36.3	16.7
- Oxidizer	0.8	0.8	216.0	23.2	14.0
Engine (to SOV) - Fuel	0.2	0.2	235.8	0.0	10.5
- Oxidizer	0.3	0.3	235.8	0.0	10.5
Isolation Squib - Fuel	0.2	0.2	218.5	-36.3	16.7
- Oxidizer	0.1	0.1	216.0	23.2	14.0
APS/RCS Interconnect - Fuel	1.3	1.3	218.5	-36.3	16.7
- Oxidizer	1.8	1.8	216.0	23.2	14.0
¹ Feed Lines - Fuel	3.7	3.7	218.5	-36.3	16.7
- Oxidizer	4.8	4.8	216.0	23.2	14.0
Total Outside Tanks - Fuel	5.6	5.6	219.1	-35.0	16.5
- Oxidizer	7.8	7.8	216.7	22.4	13.9

¹APS and DPS propellant trapped in feed lines is considered usable for depletion burns.

TABLE 5.6-1 (Continued)

LUNAR MODULE TRAPPED AND RESIDUAL PROPELLANTS

<u>APS - Trapped Inside Tanks</u>	<u>WEIGHT (Pounds)</u>	
	<u>LM-5</u>	<u>LM-6 and Subs.</u>
Tank Wetting - Fuel	1.0	1.0
- Oxidizer	1.0	1.0
Propellant Vapor - Fuel	1.0	1.0
- Oxidizer	13.8	13.8
Unporting Prevention - Fuel	7.1	7.1
- Oxidizer	11.3	11.3
"Zero-G" Cans - Fuel	1.6	1.6
- Oxidizer	2.6	2.6
Thrust Vector Deviation from Vehicle Center Line - Fuel	0.4	0.4
- Oxidizer	0.6	0.6
Engine and Valve Operation - Fuel	1.7	1.7
- Oxidizer	1.9	1.9
¹ Feed Lines - Fuel	-3.7	-3.7
- Oxidizer	-4.8	-4.8
Total Trapped in Tanks - Fuel	9.1	9.1
- Oxidizer	26.4	26.4

¹ APS and DPS propellant trapped in feed lines is considered usable for depletion burns.

TABLE 5.6-1 (Continued)

LUNAR MODULE TRAPPED AND RESIDUAL PROPELLANTS

DPS - Trapped Outside Tanks	WEIGHT (Pounds)		CENTER OF GRAVITY (Inches)		
	LM-5	LM-6 and Subs.	X _E	Y _E	Z _E
Fill and Drain Lines - Fuel	0.1	0.1	133.5	-5.3	-24.8
- Oxidizer	0.2	0.2	133.3	25.0	-1.9
Balance Lines - Fuel	7.3	7.3	133.5	-5.3	-24.8
- Oxidizer	11.3	11.3	133.3	25.0	-1.9
Branch Lines - Fuel	4.0	4.0	133.5	-5.3	-24.8
- Oxidizer	8.5	8.5	133.3	25.0	-1.9
Engine (to SOV) - Fuel	6.4	6.4	154.0	0.0	0.0
- Oxidizer	12.2	12.2	154.0	0.0	0.0
Isolation Squib - Fuel	0.7	0.7	133.5	-5.3	-24.8
- Oxidizer	0.7	0.7	133.3	25.0	-1.9
¹ Feed Lines - Fuel	12.1	12.1	133.5	-5.3	-24.8
- Oxidizer	27.5	27.5	133.3	25.0	-1.9
¹ Heat Exchanger - Fuel	4.4	4.6	155.2	-15.0	-21.3
- Oxidizer	0.0	0.0			
Total Trapped Outside Tanks - Fuel	35.1	35.1	140.0	-5.6	-19.8
- Oxidizer	60.5	60.5	137.5	19.9	-1.5

¹APS and DPS propellant trapped in feed lines is considered usable for depletion burns.

TABLE 5.6-1 (CONTINUED)
LUNAR MODULE TRAPPED AND RESIDUAL PROPELLANTS

DPS - Trapped Inside Tanks	WEIGHT (Pounds)		
	LM-10	LM-11	LM-12
Tank Wetting - Fuel	2.0	2.0	2.0
- Oxidizer	2.0	2.0	2.0
Propellant Vapor - Fuel	2.5	2.5	2.5
- Oxidizer	19.0	19.0	19.0
"Zero-G" Cans - Fuel	4.5	4.5	4.5
- Oxidizer	7.2	7.2	7.2
¹ Thrust Vector Deviation from Vehicle Center Line - Fuel (-Y Tank)	15.0±19.5	23.0±11.5	23.0±11.5
- Oxidizer (+Z Tank)	20.2±26.1	48.0±24.0	48.0±24.0
Engine and Valve Operation - Fuel Per start 1.0 lb Per shutdown 1.9 lb	2.9	2.9	2.9
- Oxidizer Per start 1.3 lb Per shutdown 1.3 lb	2.6	2.6	2.6
² Branch Line Orificing - Fuel		- 2.4±12.0	- 7.3±8.3
- Oxidizer LM-10 included in Thrust Vector Deviation		2.2±18.0	- 9.8±19.9
³ Feed Lines and Heat Exchanger - Fuel	-16.4	-16.5	-16.5
- Oxidizer	-27.5	-27.5	-27.5
Total Trapped Inside Tanks - Fuel	10.5±19.5	16.0±16.6	11.1±14.2
- Oxidizer	23.5±26.1	53.5±30.0	41.5±31.2

¹LM-11 and 12 reflect c.g. limit of ±1" in Y and/or Z. Location is in fuel and oxidizer tanks which are furthest from c.g.

²LM-10: Fuel -Y tank, oxidizer +Z tank; LM-11: Fuel +Y tank, oxidizer +Z tank; LM-12: Fuel +Y tank, oxidizer -Z tank.

³APS and DPS propellant trapped in feed lines is considered usable for depletion burns.

5.6-5

SNA-8-D-027(III)REV 3

TABLE 5.6-2

LM-10 AND SUBSEQUENT MISCELLANEOUS CONSUMABLES

ECS COOLANT:	WEIGHT (Pounds)	CENTER OF GRAVITY (Inches)		
		X _E	Y _E	Z _E
Ascent - Primary	32.1	251.9	9.9	-2.4
- Redundant	3.3	251.0	9.9	-2.4
Descent - Primary	1.7	163.5	25.0	38.0
- Redundant	0.0			
<u>GOX:</u>				
Ascent - Tank #1	2.4	266.1	15.1	-53.5
- Tank #2	2.4	266.1	-15.1	-53.5
Descent - Tank #1	46.9	185.6	38.9	-53.5
- Tank #2	46.9	185.2	41.5	48.2
<u>WATER:</u>				
Ascent - Tank #1	42.5	300.4	25.0	13.7
- Tank #2	42.5	300.4	-25.0	-13.7
*Descent - Tank #1		166.0	-43.2	-43.2
- Tank #2		141.9	43.2	43.2
<u>NITROGEN:</u>				
Ascent	0.1	301.5	+25.0	13.7
	0.1	301.5	-25.0	-13.7
Descent	0.6	169.4	-43.2	-43.2
	0.4	150.4	37.0	56.2
<u>HELIUM:</u>				
APS - Tank #1	6.6	246.2	12.2	-48.6
- Tank #2	6.6	246.2	-12.2	-48.6
RCS - Tank #1	1.05	263.0	46.1	0.6
- Tank #2	1.05	263.0	-46.1	-0.6
DPS - (SHe)	51.2	148.3	47.2	-47.8
- (Ambient)	1.1	175.8	59.2	-37.0

*See Mission Loading information in Section 3.0 for the required Descent Water load for each mission.

U N E C E R L L E K E H H K E L L A

TABLE 5.6-1 (CONTINUED)

LUNAR MODULE TRAPPED AND RESIDUAL PROPELLANTS

DPS - Trapped Inside Tanks	WEIGHT (Pounds)		
	LM-10	LM-11	LM-12
Tank Wetting - Fuel	2.0	2.0	2.0
- Oxidizer	2.0	2.0	2.0
Propellant Vapor - Fuel	2.5	2.5	2.5
- Oxidizer	19.0	19.0	19.0
"Zero-G" Cans - Fuel	4.5	4.5	4.5
- Oxidizer	7.2	7.2	7.2
¹ Thrust Vector Deviation from Vehicle Center Line - Fuel (-Y Tank)	15.0±4.2	20.5±11.5	23.0±11.5
- Oxidizer (+Z Tank)	20.2±13.2	37.8±24.0	48.0±24.0
Engine and Valve Operation - Fuel Per start 1.0 lb Per shutdown 1.9 lb	2.9	2.9	2.9
- Oxidizer Per start 1.3 lb Per shutdown 1.3 lb	2.6	2.6	2.6
² Branch Line Orificing - Fuel LM-10 included in Thrust Vector Deviation		2.4±12.0	7.3±8.3
- Oxidizer		2.2±18.0	9.8±19.9
³ Feed Lines and Heat Exchanger - Fuel	-16.4	-16.5	-16.5
- Oxidizer	-27.5	-27.5	-27.5
Total Trapped Inside Tanks - Fuel	10.5±18.0	13.5±16.6	25.7±14.2
- Oxidizer	23.5±21.2	43.3±30.0	61.1±31.2

¹LM-11 and 12 reflect c.g. limit of ±1" in Y and/or Z. Location is in fuel and oxidizer tanks which are furthest from c.g.

²LM-10: Fuel -Y tank, oxidizer +Z tank; LM-11: Fuel +Y tank, oxidizer +Z tank; LM-12: Fuel +Y tank, oxidizer -Z tank.

³APS and DPS propellant trapped in feed lines is considered usable for depletion burns.

5.6-5

SNA-8-D-027(III)REV 3

TABLE 5.6-1 (CONTINUED)

LUNAR MODULE TRAPPED AND RESIDUAL PROPELLANTS

DPS - Trapped Outside Tanks	WEIGHT (Pounds) LM-10	CENTER OF GRAVITY (Inches)		
		X _E	Y _E	Z _E
Fill and Drain Lines - Fuel	0.1	133.5	-5.3	-24.8
- Oxidizer	0.2	133.3	25.0	-1.9
Balance Lines - Fuel	0.0			
- Oxidizer	0.0			
Branch Lines - Fuel	4.1	133.5	-5.3	-24.8
- Oxidizer	8.5	133.3	25.0	-1.9
Engine (to SOV) - Fuel	6.0	154.0	0.0	0.0
- Oxidizer	12.0	154.0	0.0	0.0
Isolation Squib - Fuel	0.7	133.5	-5.3	-24.8
- Oxidizer	0.7	133.3	25.0	-1.9
¹ Feed Lines - Fuel	12.0	133.5	-5.3	-24.8
- Oxidizer	27.5	133.3	25.0	-1.9
¹ Heat Exchanger - Fuel	4.4	155.2	-15.0	-21.3
- Oxidizer	0.0			
Total Trapped Outside Tanks - Fuel	27.3	140.0	-5.6	-19.8
- Oxidizer	48.9	137.5	19.9	-1.5

5.6-4

SNA-8-D-027(III)REV 3

¹APS and DPS propellant trapped in feed lines is considered usable for depletion burns.

U U U E E E L E E E M H H E E A A A